

L8104A,B,C,D Electronic Water Heater Controllers

The L8104A,B,C,D Electronic Controllers provide temperature control and ECO limit action for gas water heaters.

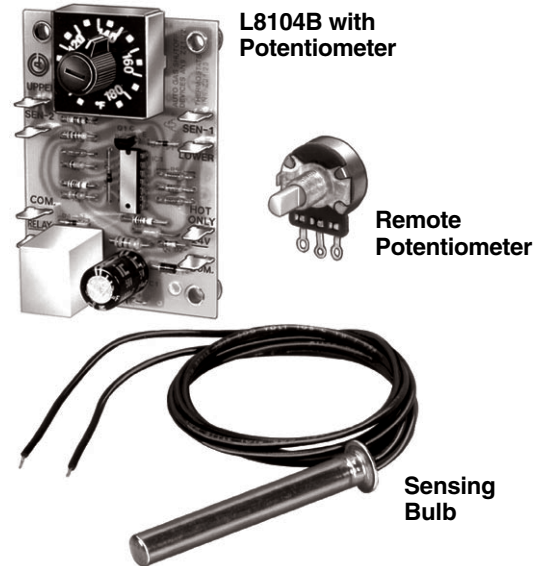

- L8104A,B are used in standing pilot and electronic ignition systems.
- L8104C,D are used only in electronic ignition systems.
- Includes electronic module, one or two sensing bulbs, and setpoint potentiometer (remote- or board-mounted).
- Sensing bulb contains thermistor sensor and ECO switch. Second bulb in L8104B,C contains thermistor only.
- L8104A has single sensing bulb.
- L8104B has two sensing bulbs available with upper and lower bulb sensing authority allocated in ratios of 1:1, 2:1, 3:1, and 4:1. Two sensing bulbs provide temperature averaging.
- L8104C has two sensing bulbs and manual reset pushbutton.
- L8104D has one sensing bulb and manual reset pushbutton.

- Temperature range is factory-set to meet application requirements. Maximum setting temperature is 200°F (93°C).
- ECO limit setting is factory-set to meet application requirements.
- For L8104A,B, standing pilot must be manually relit or ignition module must be reset when ECO shuts off gas control.
- For L8104C,D, ignition module must be reset using pushbutton switch mounted on electronic control module when ECO shuts off gas control.
- Control circuit is accurate within $\pm 3.5^{\circ}\text{F}$ (1.9°C) at maximum setpoint (200°F [93°C]; setpoint controls are accurate within $+7^{\circ}\text{F}$ [$+3.8^{\circ}\text{C}$], -0°F [-0°C]).

CONTENTS

Specifications	2
Ordering Information	2
Installation	5
Setting and Checkout	10
Operation	11
Troubleshooting	12
Material Safety Data Sheets	15



Specifications

IMPORTANT: *The specifications given in this publication do not include normal manufacturing tolerances. Therefore, this unit may not exactly match the listed specifications. Also, this product is tested and calibrated under closely controlled conditions, and some minor differences in performance can be expected if those conditions are changed.*

MODELS:

L8104A Electronic Commercial Water Heater Controller: Includes electronic control module, single sensing bulb containing thermistor and ECO switch, and remote- or board-mounted potentiometer.

L8104B Electronic Commercial Water Heater Controller: Includes electronic control module, two sensing bulbs (one with thermistor and ECO switch and one with thermistor only), and remote- or board-mounted potentiometer. Models are available with sensing authority allocated between the upper and lower sensing bulbs in ratios of 1:1, 2:1, 3:1 and 4:1; specify when ordering.

L8104C Electronic Commercial Water Heater Controller: Same as the L8104B with additional circuitry to manually reset the ECO switch.

L8104D Electronic Commercial Water Heater Controller: Same as the L8104A with additional circuitry to manually reset the ECO switch.

ELECTRICAL RATINGS:

Power Supply: 24 Vac, 50/60 Hz.

Gas Control Relay Contacts:

Inductive: 2A full load, 10A locked rotor.

Resistive: 2A.

TEMPERATURE SETTING RANGE: Temperature range factory set to meet application requirements. Maximum setting temperature is 200°F (93°C). Specify desired range when ordering.

DIFFERENTIAL: Factory set from $2 \pm 0.5^\circ\text{F}$ ($1 \pm 0.3^\circ\text{C}$) to $15 \pm 4.5^\circ\text{F}$ ($8 \pm 2.5^\circ\text{C}$). Specify when ordering.

AMBIENT TEMPERATURE RANGE AT MODULE: 0°F to +175°F (-18°C to +80°C).

ECO LIMIT SWITCH: Recycling or nonrecycling (one-shot). Sensing bulb must be replaced if nonrecycling ECO switch opens. Cutout temperature is factory set to meet application requirements. Specify type and desired cutout temperature when ordering. Recycling ECO is used on manual reset models (L8104C,D).

POTENTIOMETER:

Remote: Minimum setting is at fully counterclockwise rotation. Has 12 in. (30 cm) leadwires on terminals 1 and 2 and factory-mounted jumper across terminals 2 and 3. Specify when ordering L8104.

Board-mounted: Setting scaleplate provided. Specify range and board mounting when ordering L8104.

SENSING BULB: Bulbs available in several styles and materials with various leadwire lengths. Thermistor sensor and ECO limit are factory-mounted in bulb; leads terminate with 1/4 in. quick connects. Second bulb on L8104B contains only thermistor sensor; leads terminate with 3/16 in. quick connects.

MOUNTING:

Electronic Control Module: Mounts on enclosed panel with four no. 6 or 8 screws (obtained locally) through standoffs on module corners. Can be mounted in locations that reach up to 95 percent relative humidity (noncondensing), but avoid locations where water may drip on module.

Sensing Bulbs: Can be mounted in immersion well or directly immersed if properly sealed to prevent leakage. Well or seal must be ordered separately.

Setpoint Potentiometer: Remote potentiometer mounts through panel with nut on threaded shaft.

Ordering Information

When purchasing replacement and modernization products from your TRADELINE® wholesaler or your distributor, refer to the Tradeline Catalog or price sheets for complete ordering number, or specify—

- Order number.
- Temperature setting range desired.
- Differential setting desired.
- ECO cutout temperature desired.
- Recycling or nonrecycling ECO switch.
- Potentiometer mounted on electronic module or remote unit.
- Setting scale for board-mounted potentiometer.
- Sensing authority desired (L8104B,C only).
- Sensing bulb: Specify style, material, and lead wire length.
- Additional system components, if desired.

If you have additional questions, need further information, or would like to comment on our products or services, please write or phone:

- Your local Honeywell Home and Building Control Sales Office (please check the white pages of your phone directory).
- Home and Building Control Customer Logistics
Honeywell Inc., 1885 Douglas Drive North
Minneapolis, Minnesota 55422-4386

In Canada—Honeywell Limited/Honeywell Limitée, 35 Dynamic Drive, Scarborough, Ontario M1V 4Z9. International Sales and Service Offices in all principal cities of the world. Manufacturing in Australia, Canada, Finland, France, Germany, Japan, Mexico, Netherlands, Spain, Taiwan, United Kingdom, U.S.A.

DIMENSIONS:

- L8104: Fig. 1.
- L8104A,B: Fig. 2.
- L8104C,D: Fig. 3.

APPROVALS:

Underwriters Laboratories Inc. Component Recognized:
File No. MP466, Guide No. MBPR2.
American Gas Association Certified: Report No. 70-22A.
Canadian Gas Association Certified: Report No. 1029-
CC/T-6849.

available through your Honeywell sales representative. Please provide the ordering information indicated in the Ordering Information section to assure correct replacement components.

OTHER SYSTEM COMPONENTS (Order separately):

System	Electronic Ignition Module	Gas Control
Standing pilot	—	VR800, VR8200, or any rated 2.0A or less
Intermittent pilot	S86F,H; S8600H; S8610F,H	VR8440, VR8204 or any rated 2.0A or less

REPLACEMENT PARTS: Replacement electronic control modules, sensing bulbs, and remote potentiometers are

Fig. 1—Approximate dimensions in in. (mm) of L8104 Remote Potentiometer and Sensing Bulb.

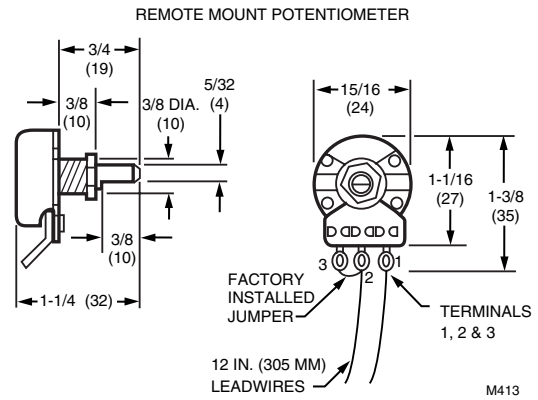
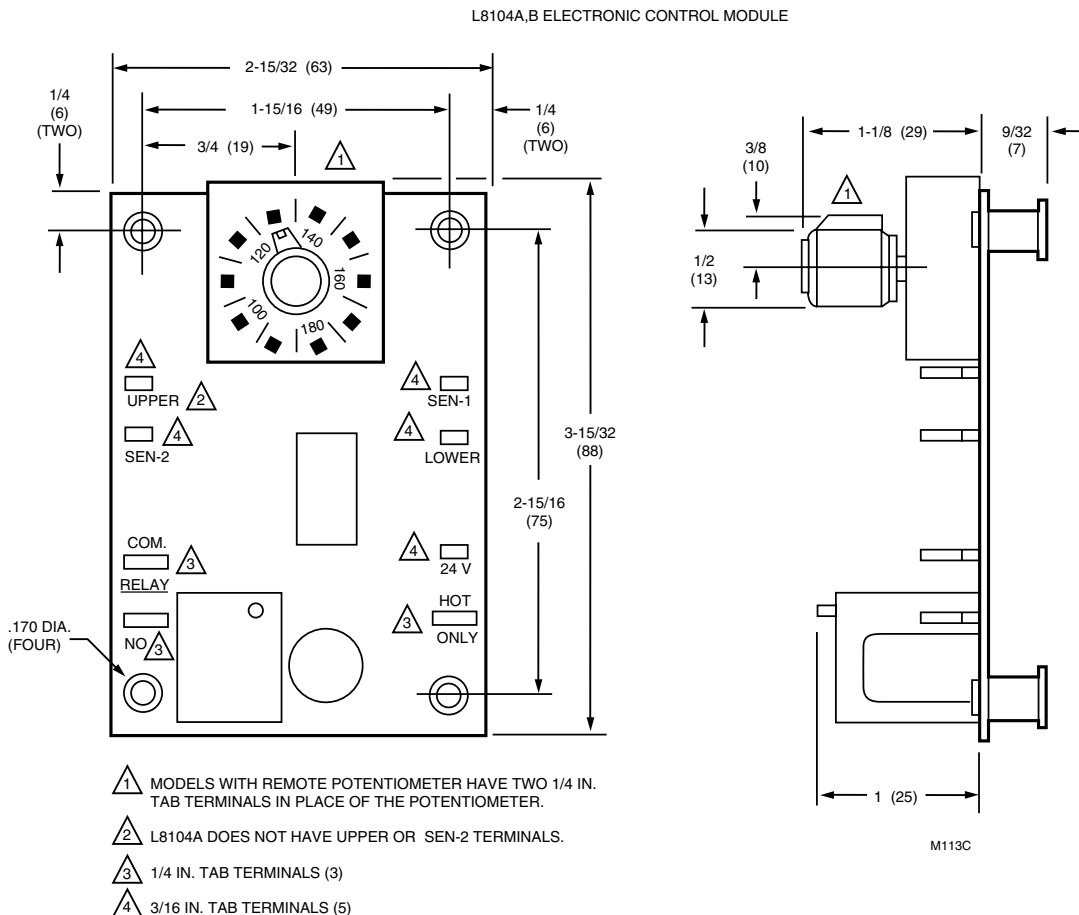

Fig. 2—Approximate dimensions in in. (mm) of L8104A,B Electronic Control Module.



ACCESSORIES:

L8104A:

4074ENP Potentiometer Assembly: 199075A Potentiometer: Clockwise turn increases temperature, two 18 in. [46 cm] leadwires with 1/4 in. quick connects. Washer and nut.

4074ENS Potentiometer Assembly: 199053A Potentiometer: Counterclockwise turn increases temperature, two 18 in. (46 cm) leadwires with one bare wire and one 1/4 in. quick connect. Washer and nut.

198800A One-Shot Sensor Assembly (nonrecycling): 189°F (87°C) cutoff temperature. 11 in. (28 cm) sensor and ECO leadwires. Sensor leadwire is 1/4 in. quick connect. ECO leadwire is stripped.

198800B One-Shot Sensor Assembly (non recycling): 200°F (93°C) cutoff temperature. 11 in. (28 cm) sensor and ECO leadwires. Sensor leadwire is 1/4 in. quick connect. ECO leadwire is stripped.

198799B Sensor Assembly: 42 in. (107 cm) 150°C (302°F) leadwires with 1/4 in. quick connects.

L8104B:

198799A Sensor Assembly: 42 in. (107 cm) 125°C (257°F) leadwires with 1/4 in. quick connects.

198799B Sensor Assembly: 42 in. (107 cm) 150°C (302°F) leadwires with 1/4 in. quick connects.

198799C Sensor Assembly: 42 in. (107 cm) 105°C (221°F) leadwires with 1/4 in. quick connects.

198799D Sensor Assembly: 42 in. (107 cm) 105°C (221°F) leadwires with 1/4 in. quick connects.

200636A Sensor Assembly: 180°F to 201°F (83°C to 94°C) cutoff temperature. 22 in. (56 cm) 150°C (302°F) leadwires.

200636B Sensor Assembly: 180°F to 201°F (83°C to 94°C) cutoff temperature. 22 in. (56 cm) 150°C (302°F) leadwires.

200636C Sensor Assembly: 180°F to 201°F (83°C to 94°C) cutoff temperature. 22 in. (56 cm) 150°C (302°F) leadwires.

200650A Potentiometer: Clockwise turn increases temperature. 8 in. (20 cm) leadwires with two 1/4 in. quick connects.

Fig. 3—Approximate dimensions in in. (mm) of L8104C,D Electronic Control Module.

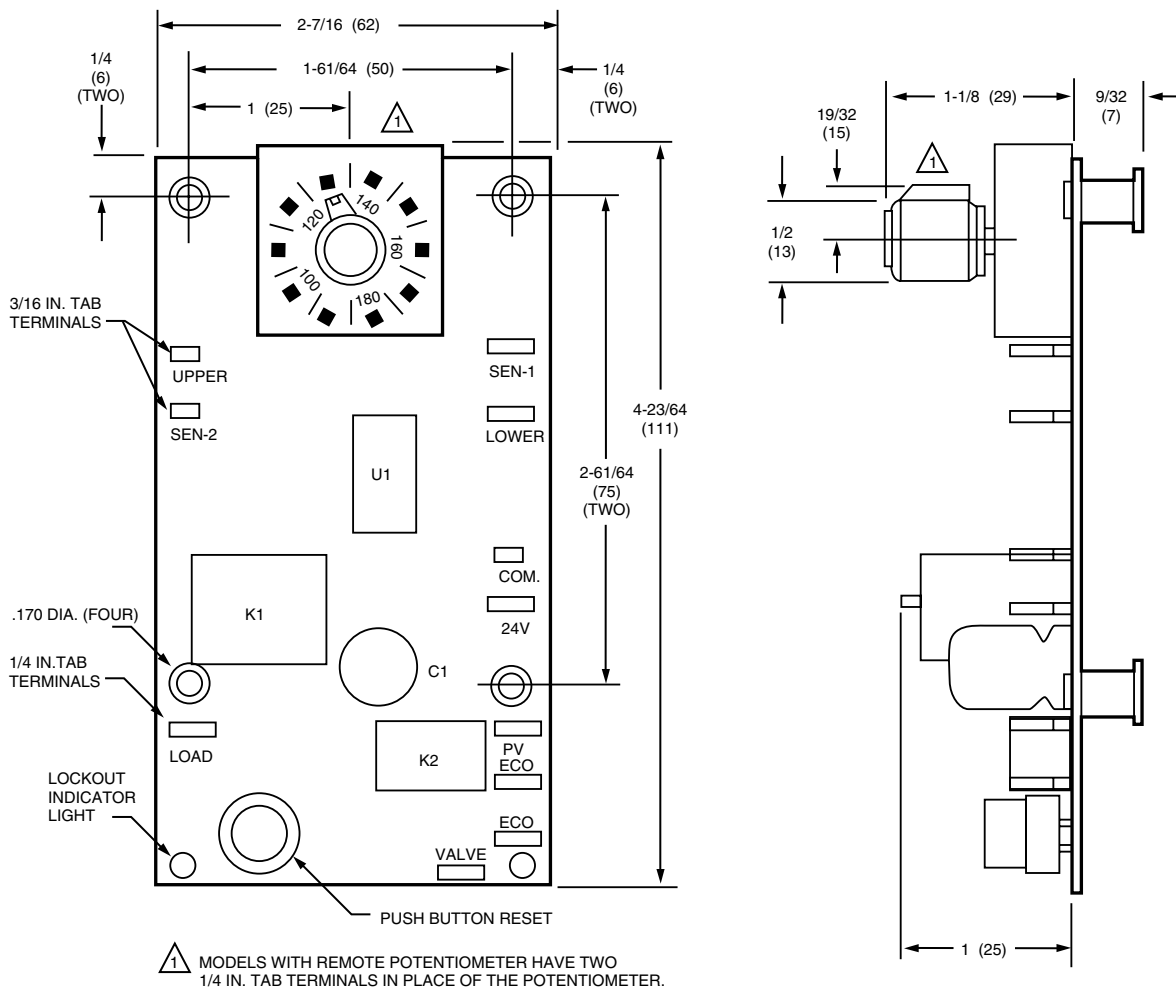

M414

Installation

WHEN INSTALLING THIS PRODUCT...

1. Read these instructions carefully. Failure to follow them could damage the product or cause a hazardous condition.
2. Check the ratings given in the instructions and on the product to make sure the product is suitable for your application.
3. Installer must be a trained, experienced service technician.
4. After installation is complete, check out product operation as provided in these instructions.



WARNING

**EXPLOSION HAZARD.
CAN CAUSE PROPERTY DAMAGE,
SEVERE INJURY OR DEATH.**

This product is for use only in a system with a pressure relief valve.



CAUTION

Disconnect power supply before wiring to prevent electrical shock or equipment damage.

IMPORTANT: Do not bend or pull on sensor leadwires when temperature is below freezing to prevent leadwire damage. Install L8104 only when temperature is above 32°F (0°C).

LOCATION AND MOUNTING

Sensing Bulb(s)

The water heater manufacturer usually provides a tapping for the sensing bulb at a point where average water temperature can be measured. With L8104B,C, the bulb containing the thermistor and ECO switch is usually mounted in the tapping near the bottom of the heater, and the other bulb is located near the top. See Fig. 4. Follow the heater manufacturer instructions.

The sensing bulb can be installed in an immersion well or directly immersed with a suitable compression fitting to prevent leakage. Wells and fittings must be ordered separately.

If an immersion well is used, the bulb should fit snugly and should touch the bottom of the well for best temperature response. Use heat-conductive compound (available in 4 oz can as Honeywell part no. 107408) to fill the space between the bulb and the well and improve heat transfer characteristics. Make sure the bulb is held firmly in the well.

If the sensor is directly immersed, use a 3/8 in. x 1/2 in. compression to M.I.P. coupling or O-ring and clamp to prevent leaks and keep bulb leadwires dry.

Electronic Control Module

Locate the electronic control module on a wall or panel in the wiring compartment of the water heater. The module must be within easy reach of the sensor leadwires in a location that is convenient for reading and changing the temperature setting. Choose a location where the module will not be exposed to water. An enclosure is recommended to help protect the module. Mount the module with four no. 6 or 8 screws through the corner standoffs.

Remote Mount Potentiometer

Choose a location that is convenient for reading and changing the temperature setting. Mount the potentiometer from the back of a panel through a 3/8 in. hole and secure it with a nut on the threaded shaft.

WIRING

IMPORTANT: For maximum trouble free operation, run the sensing bulb leadwires separately from any other current-carrying wires.

All wiring must comply with local codes and ordinances. Disconnect power supply before beginning wiring. Connect according to water heater manufacturer instructions, if available, or use Fig. 5 through 10 as a guide.

Fig. 4—Possible location of thermistor/ECO bulb and thermistor bulb.

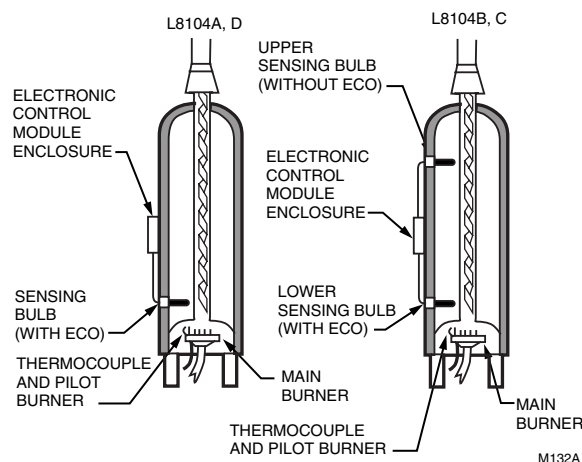

Fig. 5—L8104A with board-mounted potentiometer in a standing pilot application.

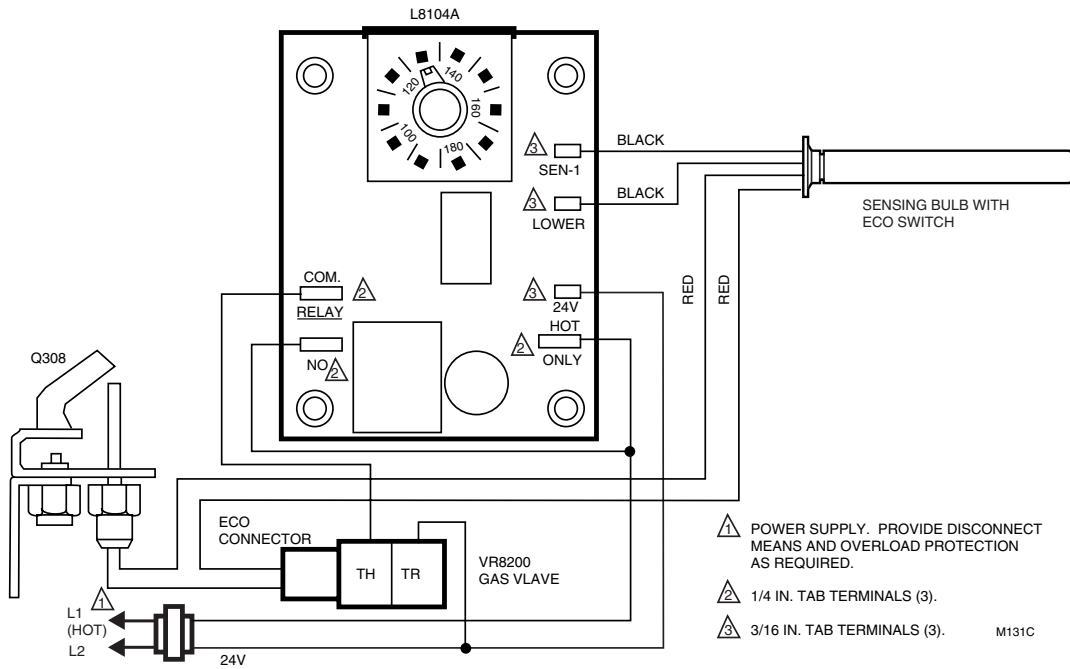

Fig. 6—L8104A with remote potentiometer in an electronic ignition application.

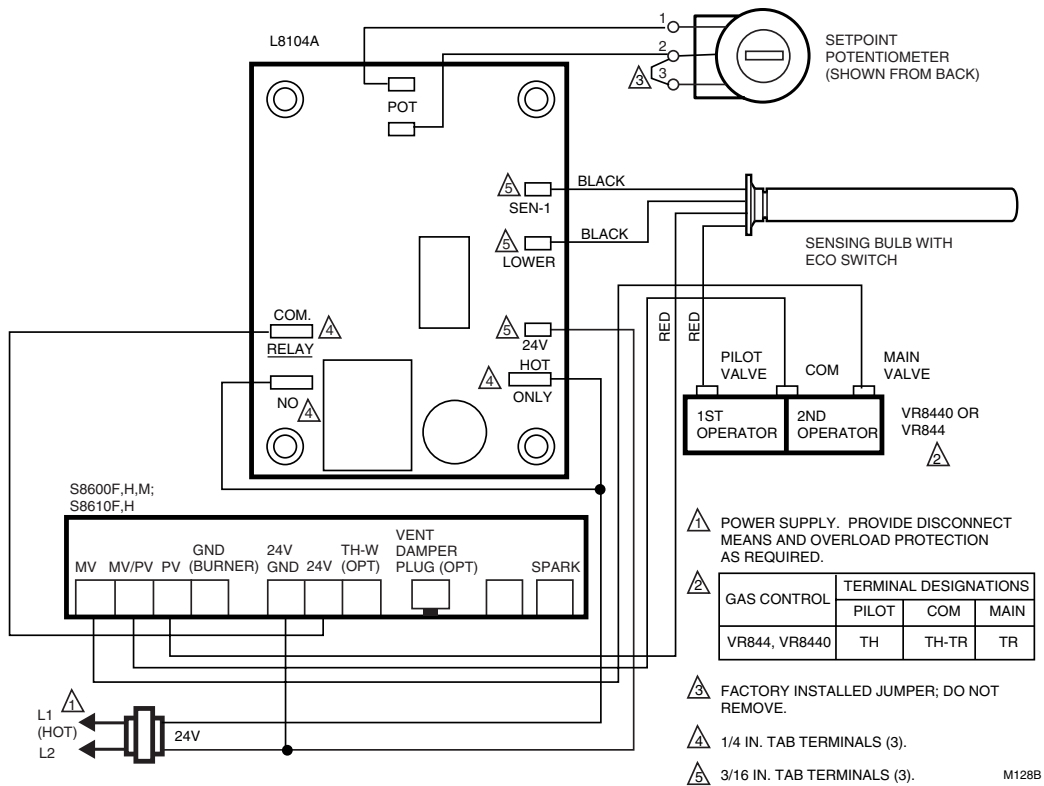

Fig. 7—L8104B with remote potentiometer in a standing pilot application.

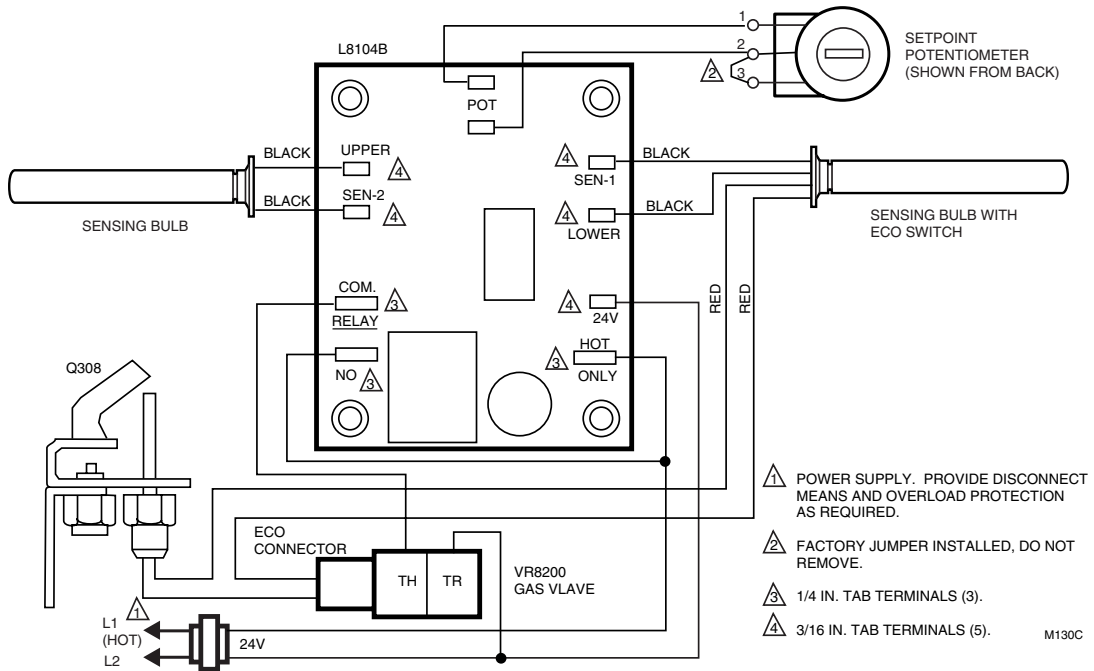

Fig. 8—L8104B with board-mounted potentiometer in an electronic ignition application.

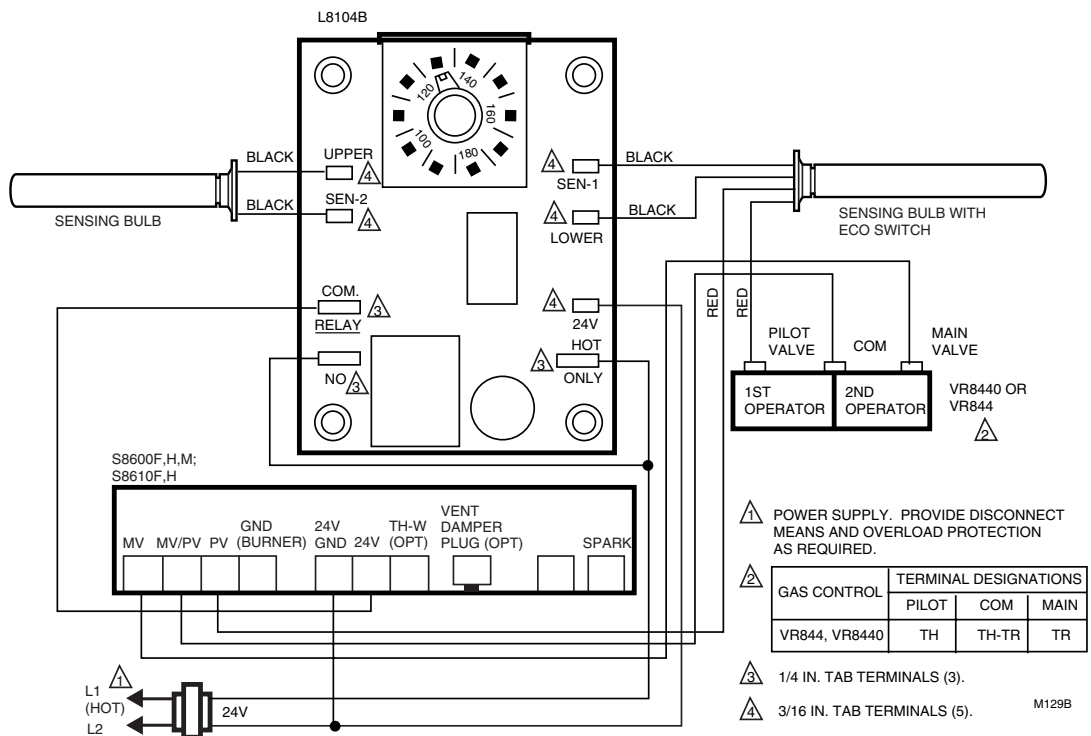
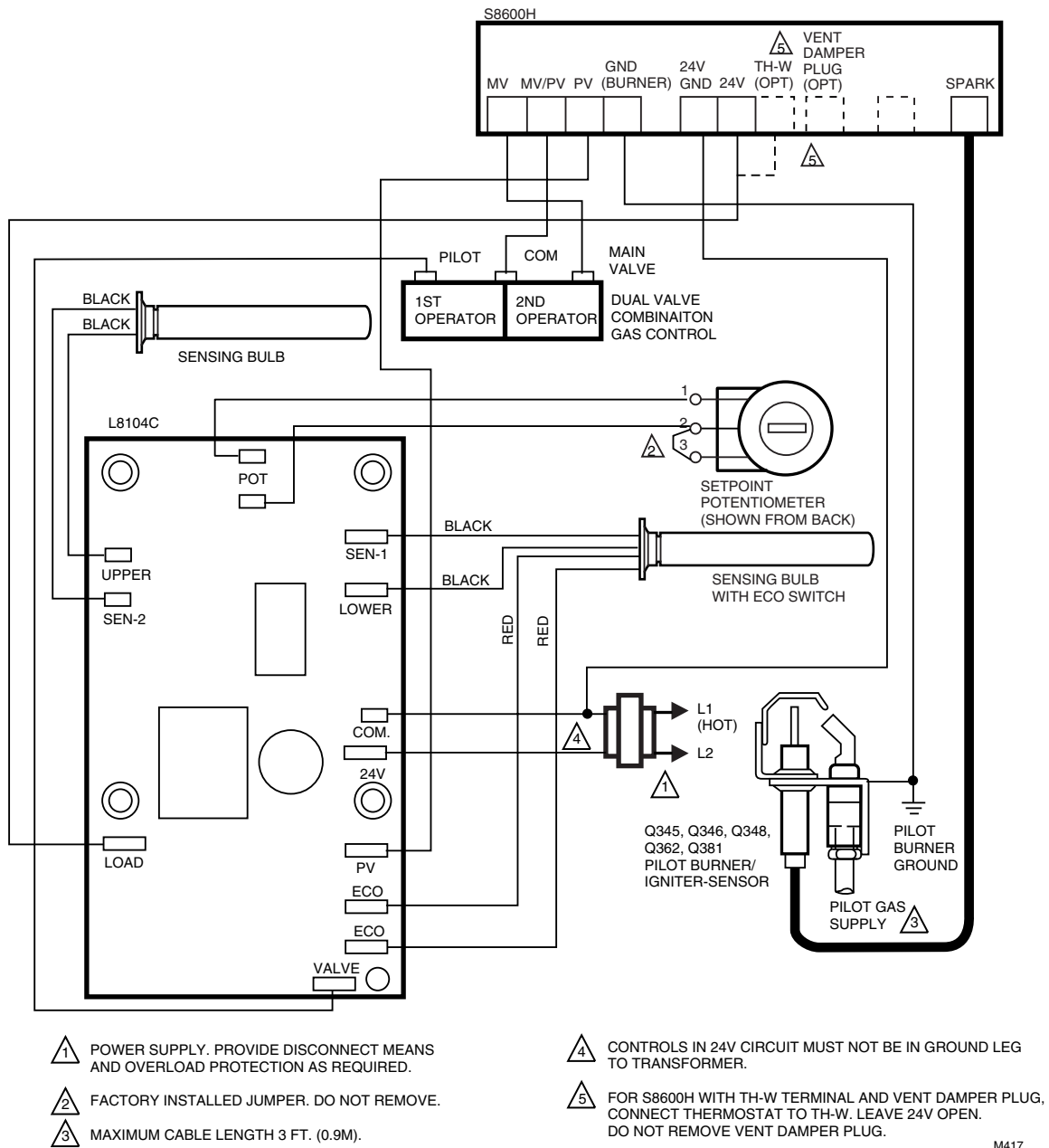
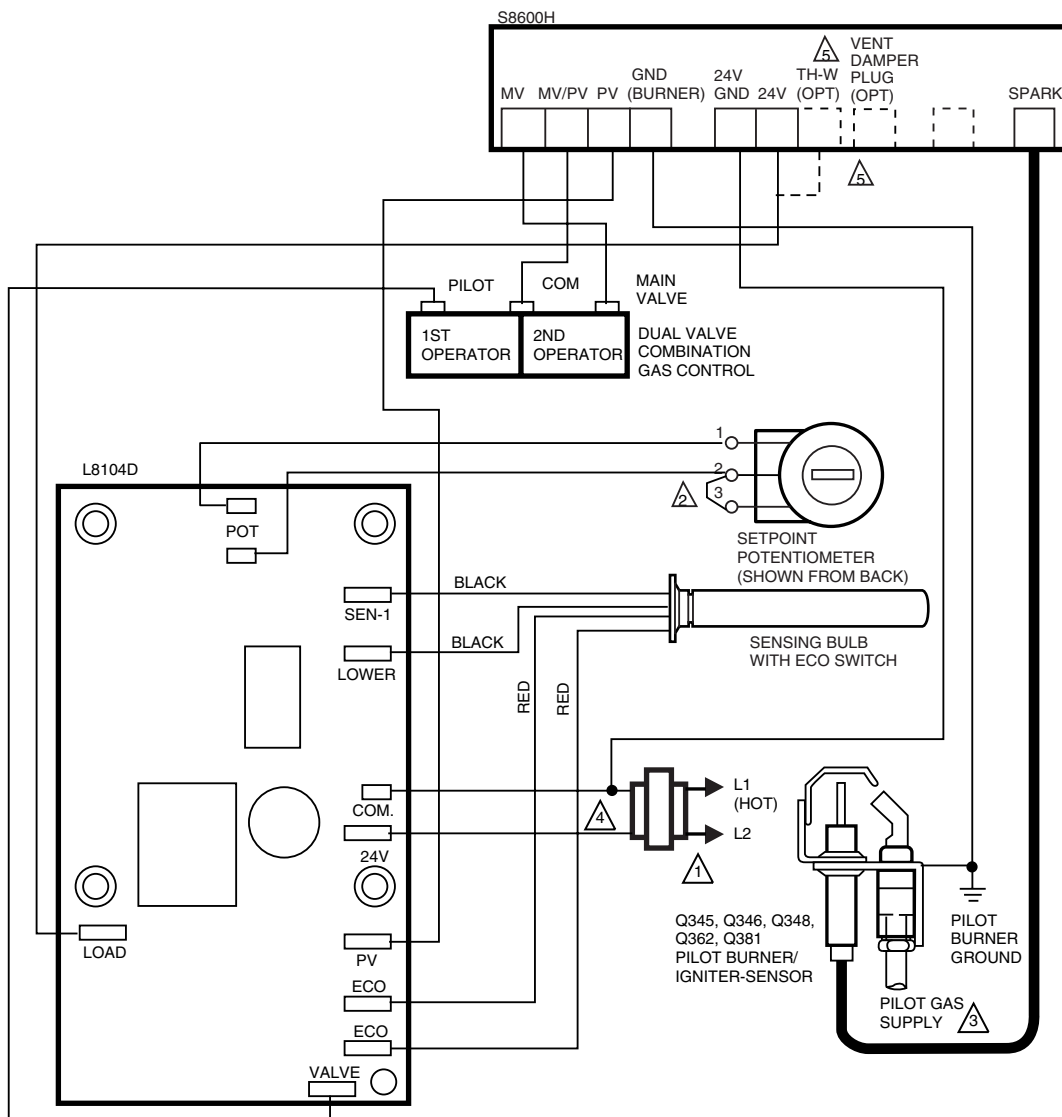

Fig. 9—L8104C with remote-mounted potentiometer in an electronic ignition application.



M417

Fig. 10—L8104D with remote-mounted potentiometer in an electronic ignition application



1 POWER SUPPLY. PROVIDE DISCONNECT MEANS AND OVERLOAD PROTECTION AS REQUIRED.

2 FACTORY INSTALLED JUMPER. DO NOT REMOVE.

3 MAXIMUM CABLE LENGTH 3 FT. (0.9M).

4 CONTROLS IN 24V CIRCUIT MUST NOT BE IN GROUND LEG TO TRANSFORMER.

5 FOR S8600H WITH TH-W TERMINAL AND VENT DAMPER PLUG, CONNECT THERMOSTAT TO TH-W. LEAVE 24V OPEN. DO NOT REMOVE VENT DAMPER PLUG.

M415

Setting and Checkout

SET CONTROL TEMPERATURE

If the potentiometer is mounted on the control module, turn the selector knob to the desired temperature.

If the potentiometer is remotely mounted, the position of the flat part of the shaft determines the approximate control temperature. Fully counterclockwise rotation when the shaft is towards you is the minimum setting. Fully clockwise rotation is the maximum setting. Actual temperature range depends on the control module and the potentiometer selected. See Fig. 11.

CHECKOUT

Set the L8104 above water temperature and observe the system through one complete cycle. Make sure system operates as desired.

To check the thermistor or thermistor/ECO assembly, compare its resistance as measured by an ohmmeter to the water temperature as measured by an accurate thermometer. Thermistor resistance increases as the temperature falls. See Table 1 or 2 for the correct sensor resistance at various temperatures.

Fig. 11—Scale range for 3K remotely mounted potentiometer when used with L8104B Dual Bulb Controller.

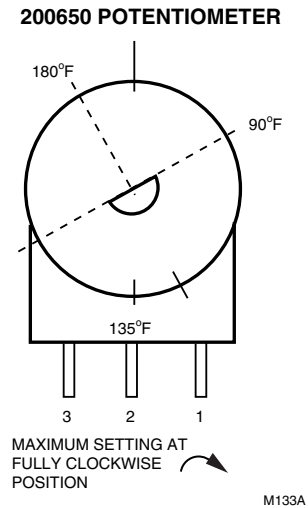

TABLE 1—THERMISTOR RESISTANCE AT VARIOUS TEMPERATURES IN FAHRENHEIT.

Temp-erature (°F)	Resistance (K ohms)									
	0	1	2	3	4	5	6	7	8	9
40	26109	25400	24712	24045	23399	22771	22163	21573	21000	20445
50	19906	19383	18876	18383	17905	17440	16990	16553	16128	15715
60	15314	14925	14548	14180	13823	13477	13140	12812	12494	12185
70	11884	11592	11308	11032	10763	10502	10248	10000	9760	9526
80	9299	9078	8862	8653	8449	8250	8057	7869	7685	7507
90	7333	7165	7000	6839	6683	6531	6383	6238	6098	5961
100	5827	5697	5570	5446	5326	5208	5094	4982	4873	4767
110	4663	4562	4464	4368	4274	4183	4094	4006	3922	3839
120	3758	3679	3602	3527	3453	3382	3312	3244	3177	3112
130	3048	2986	2925	2866	2808	2752	2697	2643	2590	2538
140	2488	2439	2391	2344	2298	2253	2209	2166	2124	2083
150	2043	2004	1966	1928	1891	1856	1820	1786	1753	1720
160	1688	1656	1625	1595	1566	1537	1509	1481	1454	1427
170	1402	1376	1351	1327	1303	1280	1257	1235	1213	1191
180	1170	1150	1129	1110	1090	1071	1053	1035	1017	999
190	982	965	949	933	917	901	886	871	857	842
200	828	814	801	788	775	762	749	737	725	713

TABLE 2—THERMISTOR RESISTANCE AT VARIOUS TEMPERATURES IN CELSIUS.

Temp- erature (°C)	Resistance (K ohms)									
	0	1	2	3	4	5	6	7	8	9
0	32648	31026	29495	28049	26682	25389	24166	23010	21915	20879
10	19898	18968	18088	17253	16461	15710	14998	14322	13680	13071
20	12492	11942	11419	10922	10450	10000	9572	9165	8778	8409
30	8057	7722	7403	7099	6808	6532	6268	6016	5775	5546
40	5327	5117	4917	4726	4543	4368	4201	4042	3889	3742
50	3602	3468	3340	3217	3099	2986	2878	2774	2675	2579
60	2488	2400	2316	2235	2157	2083	2011	1942	1876	1813
70	1752	1693	1637	1582	1530	1480	1432	1385	1340	1297
80	1256	1216	1177	1140	1105	1070	1037	1005	974	944
90	916	888	861	835	810	786	763	741	719	698

Operation

L8104A,D

When the temperature at the sensing bulb drops below the setting on the potentiometer, the relay contacts in the electronic control module make to open the gas control or turn on the ignition module. When the temperature rises to the setpoint, the relay contacts open, closing the gas control or turning off the ignition module.

The control circuit is accurate to within $\pm 3.5^{\circ}\text{F}$ ($\pm 1.9^{\circ}\text{C}$) at maximum setpoint. (180°F (83°C) setpoint controls are accurate within $+7^{\circ}\text{F}$ ($+3.8^{\circ}\text{C}$), -0°F (0°C).

L8104B,C

Operation of the L8104B,C is similar to L8104A,D except the electronic control module opens and closes the relay in response to the average of the temperatures sensed by the upper and lower sensing bulbs.

ECO LIMIT OPERATION

If the temperature at the ECO switch rises above the ECO limit setting, the contacts in the ECO switch break and turn off the water heater.

L8104A,B

The L8104A,B uses a recycling ECO switch that re-makes once the temperature drops below the ECO temperature. Before the system will restart, however, the system must be reset. On a standing pilot system, the pilot must be relit. On an electronic ignition system, power to the 100 percent lockout ignition module must be off for one minute.

A nonrecycling (one-shot) ECO switch will not remake. The sensing bulb containing the switch must be replaced.

L8104C,D

The L8104C,D uses a recycling ECO switch. When the ECO opens, the red LED on the electronic module lights and the water heater is turned off. To restart the system, press the black manual reset pushbutton until the red LED turns off. The ECO switch is closed and the system is reset.

Troubleshooting

If water temperature is too hot, proceed as follows:

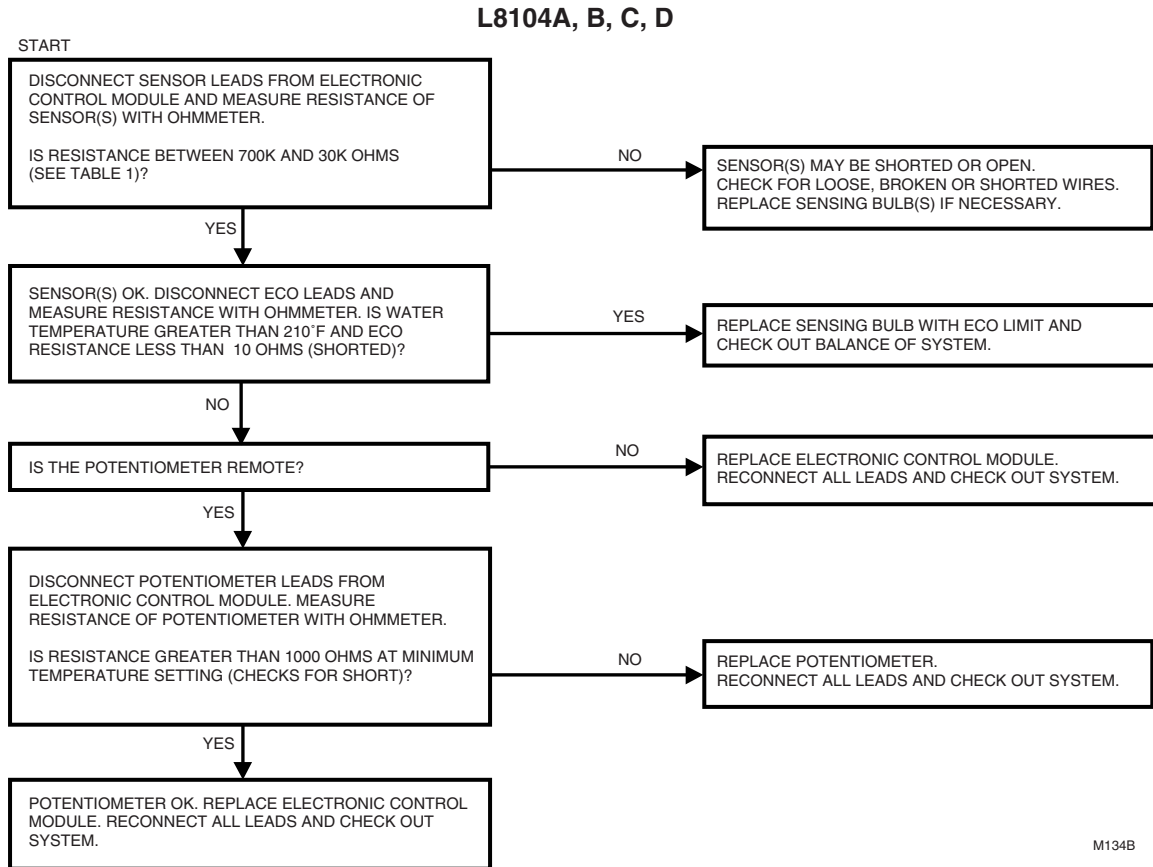

If water temperature is too cold or heater does not come on, proceed as follows:

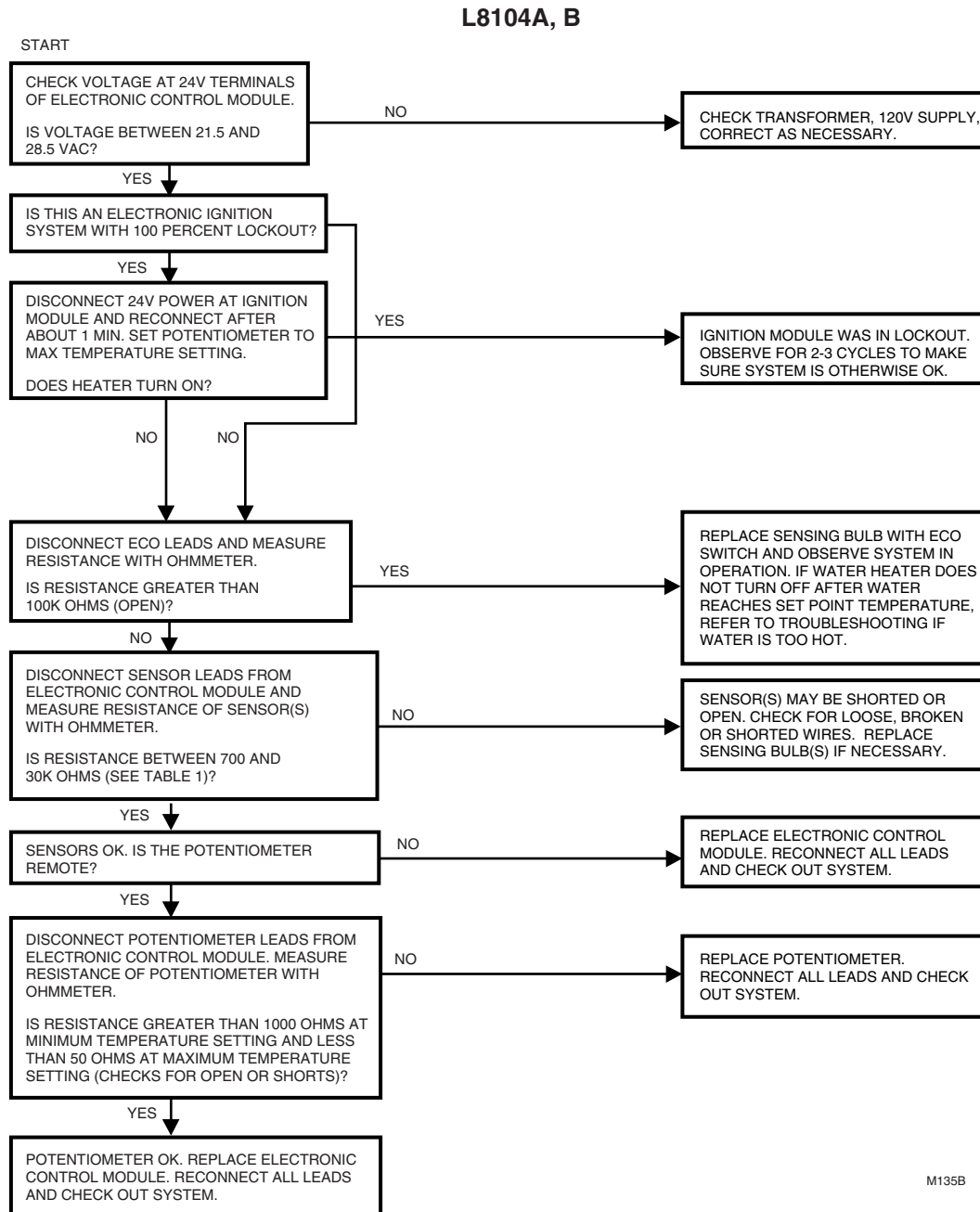

L8104C, D

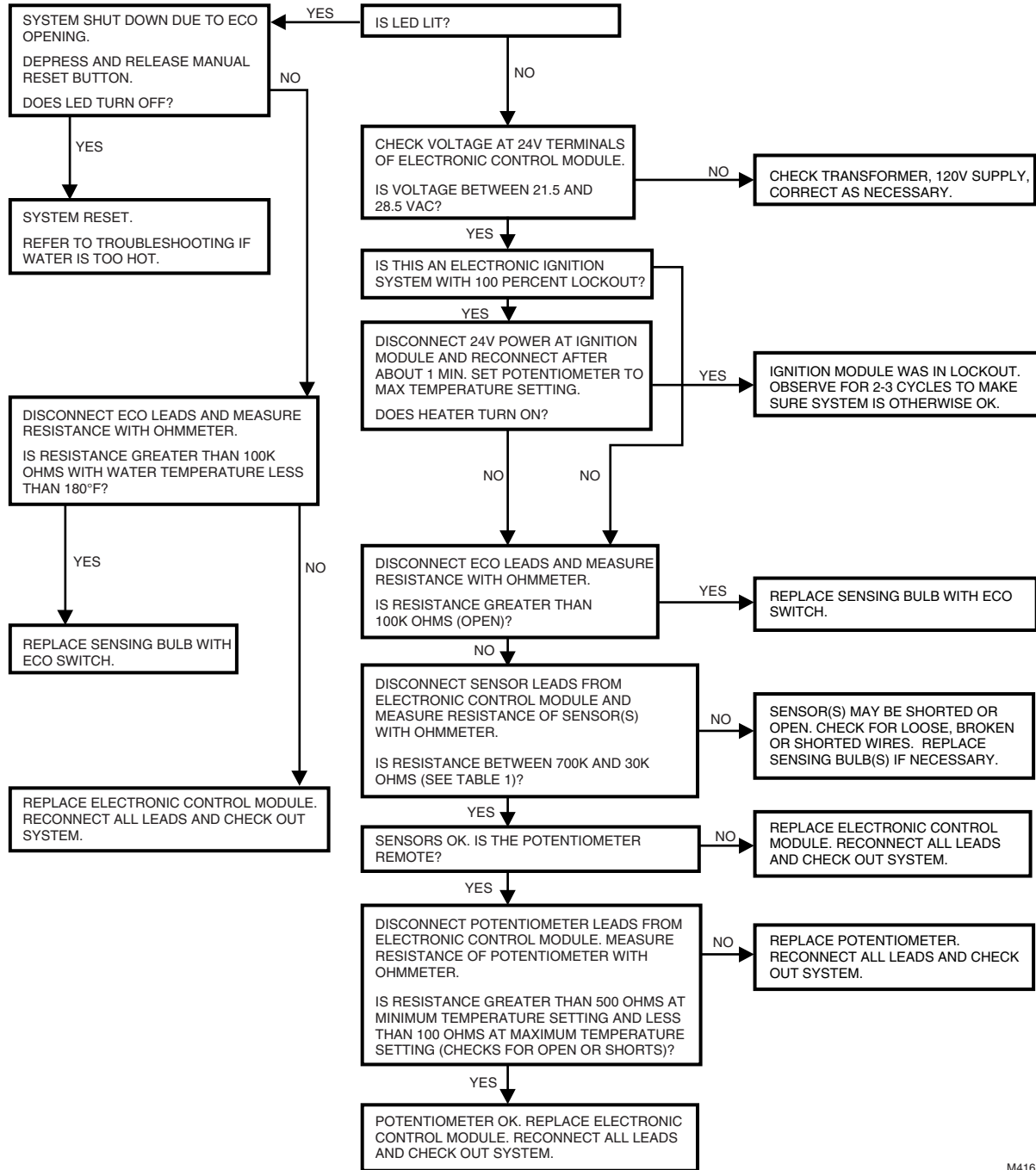

M416A

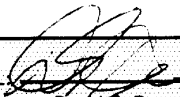
SECTION V - HEALTH HAZARD INFORMATION	
ACUTE EFFECTS/SYMPTOMS No data has been found regarding acute exposures to this material. DS 9021	
CHRONIC EFFECTS/SYMPTOMS Prolonged and/or repeated contact may cause skin, eye, and mucous membrane irritation. These potential effects are greatly minimized if good personal hygiene practices are used. No irritation has been noted in all the years of production and packaging.	
CARCINOGENICITY NTP yes <input type="checkbox"/> no <input checked="" type="checkbox"/> IARC yes <input type="checkbox"/> no <input checked="" type="checkbox"/> OSHA yes <input type="checkbox"/> no <input checked="" type="checkbox"/> OTHER NA	
FIRST AID	
EYES	Immediately flush eyes with water for 15 minutes. Obtain medical attention if irritation persists.
SKIN	Remove excess with cloth or paper. Wash with soap and water. Obtain medical attention if irritation develops or continues.
INHALATION	Inhalation is unlikely to be a route of exposure. However if this does occur, remove victim to fresh air and treat symptomatically.
INGESTION	Contact local poison control center or physician IMMEDIATELY.
SECTION VI - REACTIVITY DATA	
STABILITY	Stable.
INCOMPATIBILITY	Strong oxidizing agents and halogens.
DECOMPOSITION	Carbon dioxide, carbon monoxide, oxides of barium.
POLYMERIZATION	Will not occur.
SECTION VII - SPILL OR LEAK PROCEDURES	
PROCEDURES Use absorbant material to clean up spills. Place in appropriate containers for proper disposal.	
WASTE DISPOSAL METHOD Dispose of in accordance with Local, State and Federal regulations.	
SECTION VIII - SPECIAL PROTECTION INFORMATION	
RESPIRATORY	None.
EYEWEAR	Not normally required. However, use chemical safety goggles or faceshield if potential for eye contact exists, especially if material is heated.
CLOTHING/ GLOVES	Not normally required. However, protective clothing and gloves are recommended because material is difficult to remove from skin and clothing.
VENTILATION	No special ventilation is required when working with this product.
SECTION IX - ADDITIONAL INFORMATION	
This product is not hazardous according to DOT criteria. Keep containers closed until ready for use. Do not store near open flame or heat.	
APPROVAL:  David E. Downs, CIH, CSP	2/13/92 DATE
<small>The information contained herein has been developed based upon current available scientific data. New information may be developed from time to time which may render the conclusions of this report obsolete. Therefore, no warranty is extended as to the applicability of this information to the user's intended purpose or for the consequences of its use or misuse.</small>	

MBH039

Material Safety Data Sheet (MSDS)			HEALTH	0
			FLAMMABILITY	1
Issue Date :12/02/86 Revision Date: 03/31/95 MSDS ID MBH039			REACTIVITY	0
			PERSONAL PROTECTION	B

SECTION I - MANUFACTURER AND PRODUCT INFORMATION

Manufacturer Name: Honeywell, Inc.			Emergency Telephone Information (612) 954-4732	
Trade Name : Heat Conductive Compound				
Chemical Name or Synonym: NA			Info Telephone : (800) 328-5111	
Mfg Address : 1985 Douglas Drive North			Use: Heat conductive material used to enhance contact and heat transfer in temperature sensor applications.	
City : Minneapolis	State : MN	Zip : 55422		

SECTION II - HAZARDOUS INGREDIENTS

CAS Number	Chemical Name	Percent	PEL	C	S	TLV	C	S	Units	313?
00057-11-4	Stearic Acid	1-2				10			mg/m3	N
07429-90-5	Aluminum, as Al	24-34	15			10			mg/m3	Y
64742-41-2	Mineral Oil	20-26	5			5			mg/m3	N
64742-53-6	Hydrotreated Dist. Lt. Naphthenic Mineral Oil	20-26	5			5			mg/m3	N
64742-65-0	Pet. Dist., Dewaxed, Heavy Paraffin	13-23	5			5			mg/m3	N
68649-42-3	Zinc Alkyldithiophosphate	0-2							NA	Y
68815-49-6	Lithium Hydrostearate/Sebacate Complex	3-7				10			mg/m3	N

CAS Numbers with letters are codes for items with no valid CAS assignments; "PEL" is OSHA Permissible Exposure Limit; "C" indicates the standard is a Ceiling value; "S" indicates the chemical has a "Skin Contact" notation; "TLV" is Threshold Limit Value; "313" indicates ingredient is reportable under SARA Title III, Section 313.

Additional Information	Part No. 120650 (0.5 oz. tube); Part No. 107408 (4 oz. can); Part No. 197007 (5 gal. container); M.S. 1699. May also contain minute amounts of lithium and molybdenum lubricant compounds.
-------------------------------	--

SECTION III - HAZARDS IDENTIFICATION

Emergency Overview: Low toxicity and overall hazard. Excessive skin contact may cause dermatitis. Material is aluminum flake mixed with grease, which will burn but is not flammable.
Eye Health Effects/Symptoms : None expected. Direct contact with eye will cause irritation.
Skin Health Effects/Symptoms : Excessive contact may cause skin irritation and dermatitis.
Inhalation Health Effects/Symptoms : None expected due to form of material.
Ingestion Health Effects/Symptoms : None expected.

Heat Conductive Compound**SECTION IV - FIRST AID MEASURES**

Eyes :	Flush eyes with water for 15 minutes. Obtain medical attention if irritation persists.
Skin :	Remove excess with cloth or paper. Wash with soap and water. Obtain medical attention if irritation develops or continues.
Inhalation :	Inhalation is unlikely to be a route of exposure. However if this does occur, remove victim to fresh air and treat symptomatically.
Ingestion :	Contact local poison control center or physician IMMEDIATELY.

SECTION V - FIRE AND EXPLOSION DATA

Flammability : N	Flammable Conditions: Will burn if exposed to flame.
Flash Point (Method) : >383 F (COC)	Autoignition Temperature: >600C
LEL : NA	UEL : NA
Extinguishing Media :	CO2, dry chemical or foam.
Special Procedures :	None. As in all fire situations, firefighters should wear SCBA.
Unusual Fire & Explosion Hazards :	None. Aluminum powder can react with water to release flammable hydrogen gas. In the form of this product, this reaction is not expected.
Hazardous Combustion Products :	Oxides of carbon
Sensitivity to Impact : None	Sensitivity to Static Electricity : None
Additional Information :	NA

SECTION VI - ACCIDENTAL RELEASE PROCEDURES

Spill Procedures (Less than One Gallon) :	Scrape up and dispose as solid waste in accordance with state and federal regulations.
Spill Procedures (More than One Gallon) :	Not expected due to product packaging size.

SECTION VII - HANDLING AND STORAGE

Handling and Storage Procedures:	Keep container closed until ready for use.
---	--

Heat Conductive Compound

SECTION VIII - EXPOSURE CONTROLS/ PERSONAL PROTECTION

Ventilation :	No special ventilation is required when working with this product.
Respiratory :	None.
Eyes :	Not normally required. However, use chemical safety goggles or faceshield if potential for eye contact exists, especially if material is heated.
Clothing/Gloves :	Not normally required. However, protective clothing and gloves are recommended because material is difficult to remove from skin and clothing.

SECTION IX - PHYSICAL AND CHEMICAL PROPERTIES

Boiling Point (degrees C):	UN	Melting Point (degrees C) :	NA
Vapor Pressure (mm Hg):	NA	Percent Volatiles :	NA
Vapor Density (air = 1) :	NA	Specific Gravity :	.86
Evaporation Rate :	NA	Oxidizing Properties :	None
Solubility :	Negligible	pH :	NA
Oil/water Coefficient :	NE	Odor Threshold :	NE

Physical State, Odor and Appearance : Aluminum color, semi-solid material; pleasant odor.

SECTION X - STABILITY AND REACTIVITY

Stability :	Stable.
Incompatibility :	Strong oxidizing agents and halogens.
Decomposition :	Carbon dioxide, carbon monoxide
Polymerization :	Will not occur.

SECTION XI - TOXICOLOGICAL INFORMATION

Eye :	NE
Skin :	Skn-mouse: TD Lo: 386 g/kg/22W-I:ETA (for grease component); Skn-mouse: TDLo 480 g/kg/80W-I:NEO (for grease component)
Inhalation :	NE
Ingestion :	NE

Heat Conductive Compound

SECTION XI - TOXICOLOGICAL INFORMATION (Continued)				
Sensitization : None		Irritancy : No specific data; irritant on repeated contact		
Mutagenicity : None		Teratogenicity : None		
Reproduction : None		Synergistic : None		
Conditions Aggravated By Exposure : Existing skin rash or dermatitis				
Carcinogenicity	NTP : N	IARC : N	OSHA: N	Other: NA
SECTION XII - ECOLOGICAL INFORMATION				
Ecological Information : No specific data available; would be similar to other hydrocarbon compounds such as oil				
Chemical Fate Information : Hydrocarbon components will biodegrade in soil; relatively persistent in water.				
SECTION XIII - DISPOSAL CONSIDERATIONS				
Waste Disposal Procedures : Dispose of as solid waste in accordance with Local, State and Federal regulations.				
SECTION XIV - TRANSPORTATION INFORMATION				
Shipping and Labelling Info: Not regulated by DOT				
SECTION XV - REGULATORY INFORMATION				
Other Regulatory Information : Not regulated by DOT. SARA Title III- include in Section 311/312 inventory reports if amounts exceed 10000 pounds; not regulated under Sections 301; Aluminum compounds regulated under Section 313. Not regulated in California Prop. 65. Ingredients listed in TOSCA Inventory. Regulated by OSHA Hazard Communication (1910.1200).				
SECTION XVI - ADDITIONAL INFORMATION				
Keep containers closed until ready for use. Do not store near open flame or heat.				

The information contained herein has been developed based upon current available scientific data. New information may be developed from time to time which may render the conclusions of this report obsolete. Therefore, no warranty is extended as to the applicability of this information to the user's intended purpose or for the consequences of its use or misuse.

NA- Not Applicable NE- Not Established UN- Unknown

Page 4 of 4

Honeywell

Home and Building Control
Honeywell Inc.
1985 Douglas Drive North
Golden Valley, MN 55422

Home and Building Control
Honeywell Limited—Honeywell Limitée
740 Ellesmere Road
Scarborough, Ontario
M1P 2V9

Helping You Control Your World

Free Manuals Download Website

<http://myh66.com>

<http://usermanuals.us>

<http://www.somanuals.com>

<http://www.4manuals.cc>

<http://www.manual-lib.com>

<http://www.404manual.com>

<http://www.luxmanual.com>

<http://aubethermostatmanual.com>

Golf course search by state

<http://golfingnear.com>

Email search by domain

<http://emailbydomain.com>

Auto manuals search

<http://auto.somanuals.com>

TV manuals search

<http://tv.somanuals.com>