

Honeywell

CT50A, CT51A, CT52A, CT53A Thermostats

INSTALLATION INSTRUCTIONS

CT50A is for most gas and oil heating systems.

CT51A is for most gas and oil heating or electric cooling systems.

CT52A is for most electric heating systems.

CT53A is for millivoltage heating systems.

Do-it-yourself models

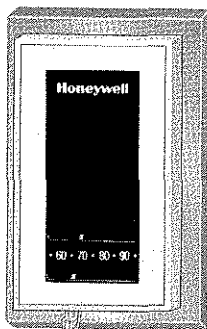

CT50A

YOUR HONEYWELL THERMOSTAT

Your new Honeywell CT50A Heating Thermostat will replace most 15 to 30 V, 2-wire heating system thermostats. The CT50A is suitable only for gas or oil heating systems (NOT for heating/cooling, heat pump, or electric heating systems).

Your new Honeywell CT51A Heating/Cooling Thermostat will replace most 15 to 30 V, 4-wire, heating/cooling system

thermostats. The CT51A is suitable only for gas or oil heating/cooling or electric cooling systems (NOT for heat pump or electric heating systems).

Your new Honeywell CT52A Heating Thermostat will replace most 15 to 30 V, 4-wire electric heating system thermostats (NOT for cooling, heating/cooling, heat pump, gas or oil systems).

Your new Honeywell CT53A Heating Thermostat is suitable for 250, 500 or 750 mV heating systems only.

Proper installation of your Honeywell thermostat will occur if you follow instructions STEP-BY-STEP. It is recommended that as you read, understand and complete each step, you check it off with pencil or pen.

1

PREPARATION

Check thermostat suitability for your home's system by reviewing YOUR HONEYWELL THERMOSTAT section, above.

Assemble tools required, as shown below.

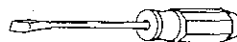

FLAT BLADE
SCREWDRIVER

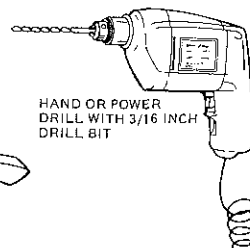

HAND OR POWER
DRILL WITH 3/16 INCH
DRILL BIT

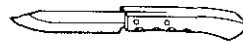

WIRE
CUTTER/STRIPPER
OR SHARP KNIFE

CONTENTS

STEP

| | |
|--------------------------------------|----------|
| <u>PREPARATION</u> | <u>1</u> |
| <u>THERMOSTAT FEATURES</u> | <u>2</u> |
| <u>REMOVING OLD THERMOSTAT</u> | <u>3</u> |
| <u>WIRE AND MOUNT NEW THERMOSTAT</u> | <u>4</u> |
| <u>CHECK OUT THE THERMOSTAT</u> | <u>5</u> |
| <u>THERMOSTAT SETTING</u> | <u>6</u> |
| <u>TROUBLESHOOTING</u> | <u>7</u> |
| <u>RECALIBRATE THERMOMETER</u> | <u>8</u> |

LIMITED ONE-YEAR WARRANTY

Honeywell warrants this product to be free from defects in workmanship or materials, under normal use and service, for a period of one (1) year from the date of purchase by the consumer. If, at any time during the warranty period, the product is defective or malfunctions, Honeywell shall repair or replace it (at Honeywell's option) within a reasonable period of time.

If the product is defective,

- return it, with a bill of sale, receipt, or other dated proof of purchase, to the dealer or contractor from which you purchased it, or
- package it carefully, along with a bill of sale, receipt, or other dated proof of purchase, and a short description of the malfunction, and mail it, postage prepaid, to the following address:

Honeywell Inc.
Return Goods
8841 Tenth Avenue North
Minneapolis, MN 55427-4375

This warranty does not cover removal or reinstallation costs. This warranty shall not apply if it is shown by Honeywell that the defect or malfunction was caused by damage which occurred while the product was in the possession of a consumer.

Honeywell's sole responsibility shall be to repair or replace the product within the terms listed above. HONEYWELL SHALL NOT BE LIABLE FOR ANY LOSS OR DAMAGE OF ANY KIND, INCLUDING ANY INCIDENTAL OR CONSEQUENTIAL DAMAGES RESULTING, DIRECTLY OR INDIRECTLY, FROM ANY BREACH OF ANY WARRANTY, EXPRESS OR IMPLIED, OR ANY OTHER FAILURE OF THIS PRODUCT. Some states do not allow the exclusion or limitation of consequential damages, so this limitation may not apply to you.

THIS WARRANTY IS THE ONLY EXPRESS WARRANTY HONEYWELL MAKES ON THIS PRODUCT. THE DURATION OF ANY IMPLIED WARRANTIES, INCLUDING THE WARRANTIES OF MERCHANTABILITY AND FITNESS FOR A PARTICULAR PURPOSE, IS HEREBY LIMITED TO THE ONE YEAR DURATION OF THIS WARRANTY. Some states do not allow limitations on how long an implied warranty lasts, so the above limitation may not apply to you.

This warranty gives you specific legal rights, and you may have other rights which vary from state to state.

If you have any questions concerning this warranty, please write our Consumer Affairs department, Honeywell Inc., 1685 Douglas Drive North, Golden Valley, MN 55422-4386 or call collect at 612/542-3300.

S.M.
9-85

Printed in U.S.A.

Form Number 69-0265
©Honeywell Inc. 1985

Make certain that your burner/air conditioner (where applicable) are working, especially if they have been inoperative for any length of time. If either does not work, contact your local heating/air conditioning dealer. Do NOT operate the air conditioning system if outdoor temperature is below 50 F [10 C].

2

THERMOSTAT FEATURES

Download from www.manualslib.com. All Manuals Search And Download.

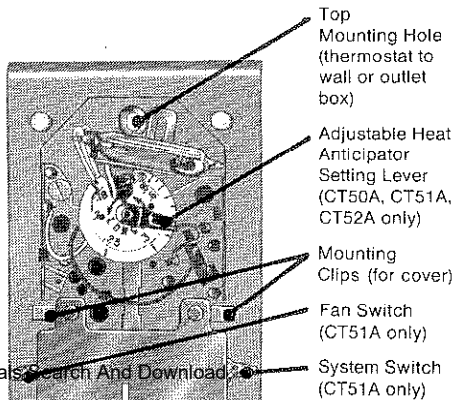

Carefully unpack your new thermostat.

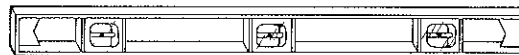

3

REMOVING OLD THERMOSTAT

(See illustration under step 4 to help you recognize the heat anticipator.) Make a note

Begin by turning off power to the heating/cooling system at the main fuse panel. Most residential systems have a separate switch box or circuit breaker for disconnecting power to the furnace.

Remove cover of old thermostat—cover normally snaps off when pulled firmly from the bottom. If it resists, check for a screw that locks the cover on.

For CT50A, CT51A, or CT52A installation, before removing the old thermostat from the wall, look at it carefully to locate the heat anticipator adjustment mechanism. (See last illustration under

step 4 to help you recognize the heat anticipator.) Make a note here of that anticipator setting for future reference. The heat anticipator pointer, if adjustable, will be set at one of a series of numbers representing the (electrical) current rating of the primary control in your furnace. The number will be one of the following: .2, .4, .8, etc., or 0.2, 0.4, 0.8, etc. If no heat anticipator/indication is showing, do not be concerned; move on to the next step.

Loosen screws holding thermostat base to subbase or wall, and lift away.

Disconnect wires from old thermostat

or subbase. If your thermostat has more than 2 wires, as you disconnect each wire, tape the end and label it with the letter of the terminal designation to make reconnection to new thermostat easier. Take care that these wires do not fall back into the wall opening.

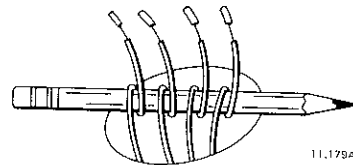

11,179A

Retain the old thermostat for reference purposes until your new thermostat is functioning smoothly.

4

WIRE AND MOUNT THERMOSTAT

For CT50A:
Connect each wire from the wall to either terminal on the back of the thermostat. Tighten the screws.

For CT51A, CT52A:
Connect wires from the wall to matching terminals on back of thermostat. Tighten the screws.

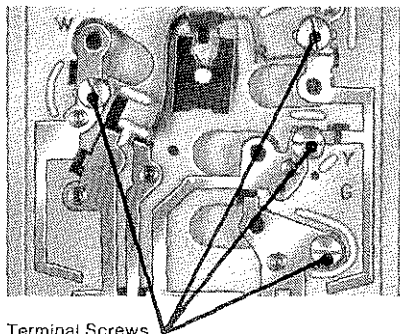

Terminal Screws
(CT51A shown)

For CT53A:
Connect wires to R and W for 750 mV systems. Connect to R and Y for 250 or 500 mV systems. Tighten the screws.

Push excess wire back into wall and plug hole with nonflammable insulation to prevent drafts from affecting thermostat operation.

Grasp the thermostat cover at the top and bottom with one hand. Pull outward on the top edge of the thermostat cover until it snaps free of the thermostat base.

Carefully remove and discard the red plastic pin located above the mercury switch. This pin protects the switch and bimetal assembly during shipment.

Fasten thermostat to wall or vertical outlet box with a screw through the top mounting hole. See step 2 for hole location.

Place a bubble level or plumb line against the thermostat to find the level position. Start a screw in the center of the bottom mounting hole. Move the temperature setting lever if necessary to uncover the mounting hole.

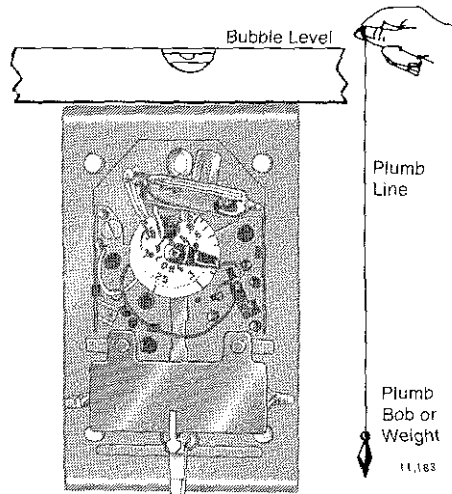

11,183

(Step 4 continued)

4 WIRE AND MOUNT THERMOSTAT (continued)

- Recheck for level positioning, and firmly tighten both mounting screws.
- If installing CT50A, CT51A, or CT52A, make sure you have the current (anticipator setting) for your system. This is the number you wrote in the box in step 3. If you were unable to find the current draw for step 3, this information can be found printed on the primary control at the furnace. The primary control is usually a gas valve, zone valve, or a relay or burner control box with the thermostat wires connected to it.

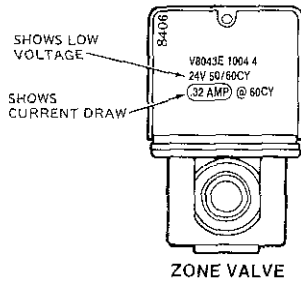

ZONE VALVE

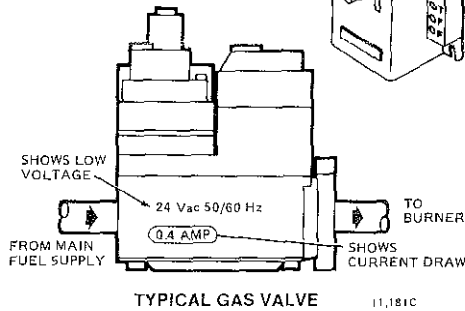
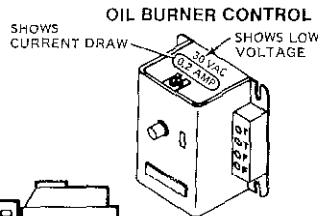

- On the CT50A, CT51A, or CT52A, set heat anticipator indicator at rating printed on primary control.

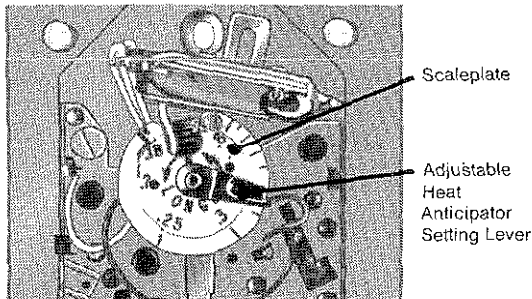

- Press the thermostat cover firmly onto the mounting clips.

5

CHECK OUT THE THERMOSTAT

- On the CT51A, the system switch controls as follows:
HEAT—heating system only operates.
OFF—heating and cooling systems are disconnected.
COOL—cooling system only operates.
- The fan switch controls as follows:
- AUTO—fan operates when heating or cooling system operates.
 - ON—fan operates continuously.

NOTE: In the following instruction, disregard heating or cooling directions if not applicable to your system.

- Turn on power to the heating/cooling system.
- Observe system operation for at least one cycle on both heating and cooling. To observe:
 - Place the system switch at HEAT position and fan switch at AUTO. Move the temperature setting lever 10 F [5.6 C] above room temperature. The heating equipment should turn on. A short warm-up period may be required before the system fan turns on.
 - Place system switch at COOL position and move temperature setting lever 10 F [5.6 C] below room temperature. The cooling equipment should turn on and the system fan should turn on.

NOTE: Some systems have a time delay that can prevent operation up to 30 seconds.

- Turn the fan switch to ON. The system fan should turn on, and operate continuously. The system blower should continue to operate at any system switch or thermostat setting.

6

THERMOSTAT SETTING

- On CT51A, place the system and fan switches at the desired settings for operation.
- On all models, move the temperature setting lever to the desired temperature comfort level.

7

TROUBLESHOOTING

Your Honeywell thermostat requires little or no attention. Most problems can generally be traced to the following:

NOTE: If your system is heating-only or cooling-only, disregard sections not applicable to your system.

| SYMPTOM | PROBLEM | CORRECTIVE ACTION |
|--|--|--|
| No heat | System switch at OFF or COOL Position. | Move switch to HEAT position. |
| | Blown fuse or tripped circuit breaker. | Replace fuse or reset circuit breaker. |
| | Furnace power switch is on OFF. | Switch to ON. |
| | No pilot flame. | Relight pilot flame per furnace manufacturer's instructions. |
| | Improper connections to thermostat. | With Power to furnace OFF, tighten all mounting and terminal screws. Repair broken wires. |
| Furnace turns on and off. | Defective thermostat. (Here's how you tell: Turn power to furnace OFF. Then remove the thermostat from the wall. Disconnect wire from W terminal. Turn power to furnace ON. Touch W wire to R terminal. The thermostat is defective if the burner comes on.) | Exchange the thermostat (see Warranty). |
| | Other. | Contact service technician for assistance. |
| Major swings in temperature (greater than 2 F [1.1C] when outside temperature stable). | Burner-on period is too short. | Remove the thermostat cover and move the heat anticipator lever COUNTERCLOCKWISE ↺ one scale mark. Wait at least several hours to stabilize. |
| | Burner-on period is too long. | Remove the thermostat cover and move the heat anticipator lever CLOCKWISE ↻ one scale mark. Wait several hours for the system to stabilize. |

| SYMPTOM | PROBLEM | CORRECTIVE ACTION |
|--|---|---|
| Thermostat setting and thermometer reading disagree. | Thermostat is not level. | Recheck the thermostat position on wall. Use a bubble level to make sure it's level. See step 4. |
| | Thermostat affected by drafts or radiant heat. | Contact service technician to change the location. The thermostat should be about 5 ft [1.5 m] above the floor and on an inside wall. |
| | Thermostat is out of calibration. | Contact a qualified service technician to recalibrate the thermostat. |
| | Thermometer is out of calibration. | Recalibrate. See step 8. |
| No cooling. | System switch in in OFF or HEAT position. | Move switch to COOL position. |
| | Blown fuse or tripped circuit breaker. | Replace fuse or reset circuit breaker. |
| | Condenser switch (located outdoors) is turned OFF. | Move switch to ON position. |
| | Improper connections to thermostat. | With power to furnace OFF, tighten all mounting and terminal screws. Repair broken wires. |
| | Defective thermostat. (Here's how you tell: Turn power to cooling system OFF. Then remove the thermostat from wall. Disconnect wire from Y terminal. Turn power to cooling system ON. Touch Y wire to terminal R. The thermostat is defective if the compressor starts. Some systems have a time delay, so allow at least 2-3 minutes.) | Exchange the thermostat. See Warranty. |
| Other. | Contact service technician for assistance. | |

8

RECALIBRATE THERMOMETER

If the thermostat set point and the thermometer reading do not agree, the thermometer may need recalibration. Follow the procedure below.

- Remove thermostat cover.
- Set the cover on a table near an accurate thermometer.
- After allowing 5 or 10 minutes for stabilization, compare the readings.

- If the readings are the same, replace cover and put the system into operation.
- If the readings are different, insert a hex-head wrench in the thermometer shaft and turn it until the thermometers have the same reading.
- Replace cover and put the system into operation.

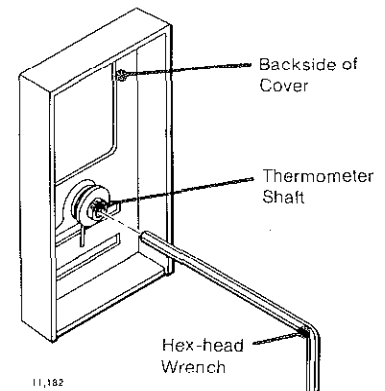

11,182

Free Manuals Download Website

<http://myh66.com>

<http://usermanuals.us>

<http://www.somanuals.com>

<http://www.4manuals.cc>

<http://www.manual-lib.com>

<http://www.404manual.com>

<http://www.luxmanual.com>

<http://aubethermostatmanual.com>

Golf course search by state

<http://golfingnear.com>

Email search by domain

<http://emailbydomain.com>

Auto manuals search

<http://auto.somanuals.com>

TV manuals search

<http://tv.somanuals.com>