

## Honeywell CT3600/CT3697 PROGRAMMABLE THERMOSTAT

### OWNER'S GUIDE

Seven Day Programmable Heat and/or Cool  
Low Voltage (20 to 30 Vac) Thermostat and Wallplate  
Model CT3600/CT3697

Para obtener un documento con las instrucciones en español, por favor visite  
nuestro sitio de web a: [www.honeywell.com/yourhome](http://www.honeywell.com/yourhome).  
Pour obtenir des notices techniques en français, veuillez consulter notre site web  
[www.honeywell.com/yourhome](http://www.honeywell.com/yourhome).

### Contents

Step 1. Prepare for Installation .....	5
Step 2. Remove Old Thermostat .....	6
Step 3. Mount Thermostat Wallplate .....	7
Step 4. Wire Wallplate Terminals .....	8
Step 5. Install the Batteries .....	9
Step 6. Set Fan Operation Switch .....	10
Step 7. Mount the Thermostat .....	11
Step 8. Customize Your Thermostat .....	11
Step 9. Set the Clock .....	13
Step 10. Programming .....	14
Step 11. Operating Your Thermostat .....	17
Step 12. Set the Fan and System Switches .....	19
If You Have a Problem .....	20
Smart Response™ Technology .....	21
Wiring Diagrams .....	22



# Total comfort temperature management with Smart Response™ Technology.

Congratulations! You made a smart choice by purchasing your new Honeywell thermostat; the smart thermostat that;

- *Keeps you comfortable* by automatically calculating exactly when the furnace or air conditioning should go on to have the house at the desired comfort temperature by the time you wake up or return home.
- *Saves the maximum amount of energy and money* by automatically remembering to adjust the temperature when you leave home or go to sleep.
- *Provides the ultimate in comfort and convenience.* It comes preprogrammed. You can use the preprogrammed schedule, or set your own.

This manual answers many of the questions that can arise as you become familiar and comfortable with your Honeywell thermostat — the state of the art in home comfort controls.

Read these instructions carefully. Failure to follow these instructions can damage the product or cause a hazardous condition.



## MERCURY NOTICE

If this thermostat is replacing a control that contains mercury in a sealed tube, do not place your old control in the trash. Contact your local waste management authority for instructions regarding recycling and the proper disposal of this control, or of an old control containing mercury in a sealed tube.

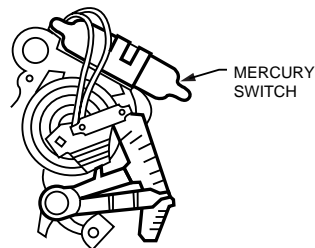

**TYPICAL LOCATION OF A MERCURY SWITCH IN A THERMOSTAT**

M10614

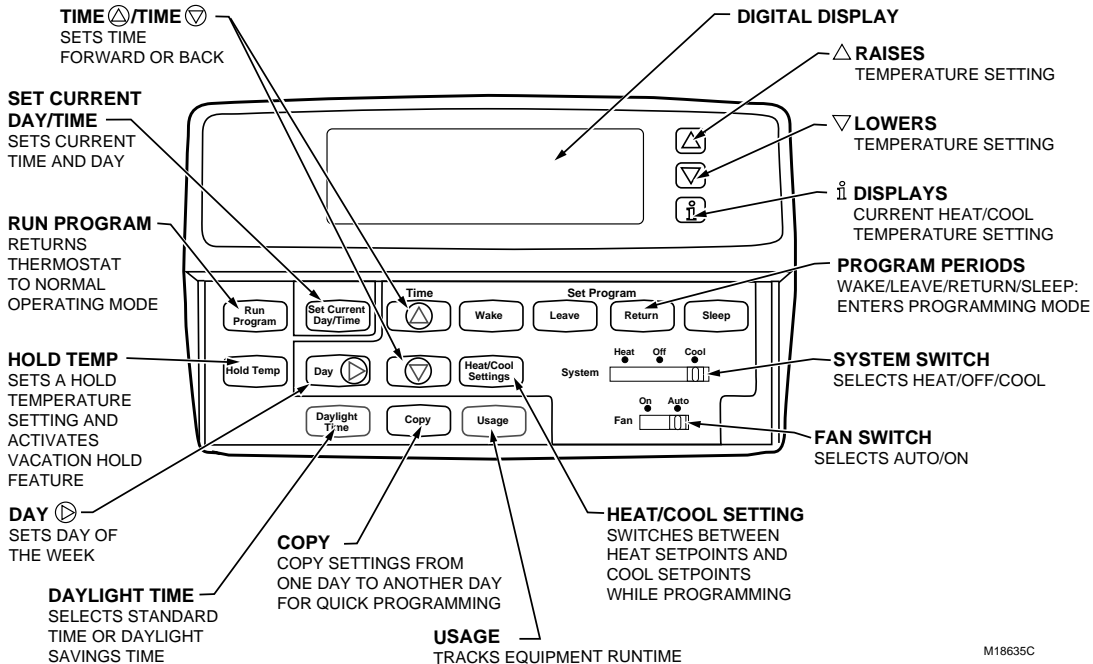

M18635C

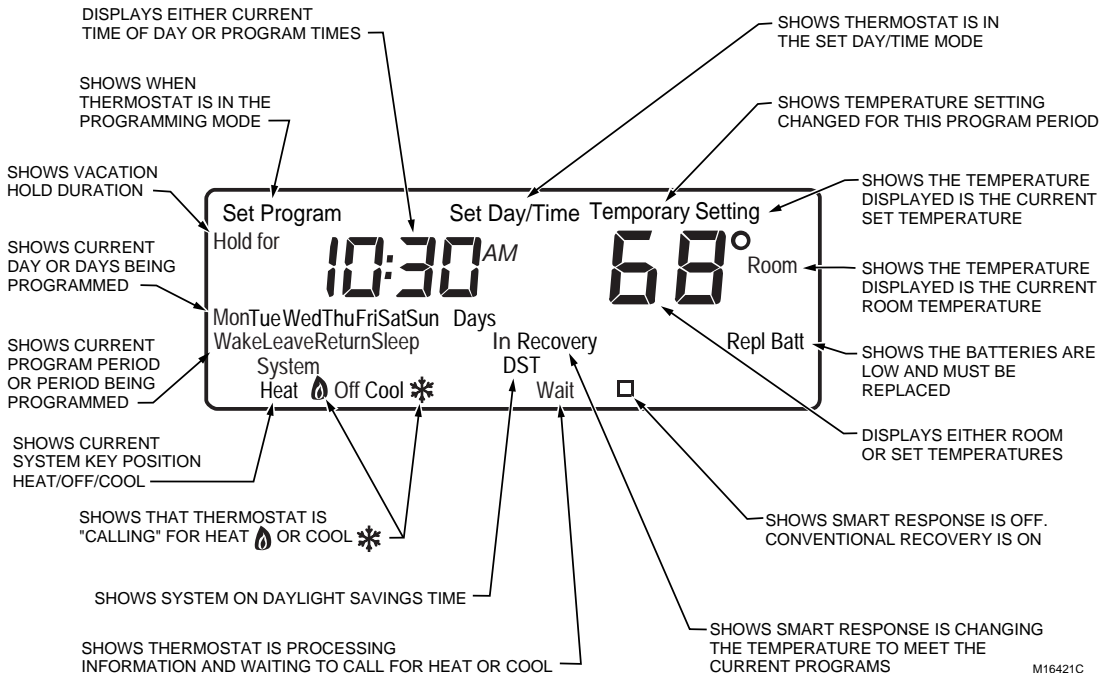

M16421C

# STEP 1. PREPARE FOR INSTALLATION

- ❑ Check Table 1, the compatibility chart, to make sure the thermostat is compatible with your system. If your system is not compatible, call Honeywell Customer Relations Center, toll-free, 1-800-468-1502.

**Table 1. Compatibility Chart.**

<b>System Type</b>	<b>Compatibility with CT3600/ CT3697</b>
Gas — Standing Pilot	Yes
Gas — Electronic Ignition	Yes
Gas-fired Boilers	Yes <sup>a</sup>
Gas — 750 Millivolt Heat only <sup>b</sup>	Yes
Oil-Fired Boilers	Yes <sup>a</sup>
Oil-Fired Furnace	Yes
Electric Furnace	Yes
Electric Air Conditioning	Yes
Baseboard Electric (120/240 line volt) <sup>c</sup>	No
Single Stage Heat Pump	Yes
Multistage Heat Pumps/Multistage Equipment	No

<sup>a</sup> Compatible with 2-wire Honeywell and Taco zone valves. Not compatible with 3-wire zone valves or 2-wire White Rodgers no. 1361 zone valves.

<sup>b</sup> Millivolt system must be heating only.

<sup>c</sup> Not compatible with any 120/240 volt system.

## Package Contents

- Thermostat
- Wiring labels
- Wallplate
- Owner's Guide
- Screws and anchors

## Tools Required

- Screwdriver
- Drill

## STEP 2. REMOVE OLD THERMOSTAT

- ❑ Test your heating and cooling systems to make sure they work properly. If either system does not work, contact your local heating/air-conditioning dealer. To avoid compressor damage, do not operate the cooling system when outdoor temperature is below 50°F (10°C).
- ❑ Turn off power to the system at the furnace or the fuse/circuit breaker panel.
- ❑ Carefully unpack your new thermostat and wallplate. Save package of screws, instructions, and receipt.
- ❑ Remove the cover from the old thermostat. If the cover does not snap off when pulled firmly from the bottom, check for a screw or screws used to lock on the cover.
- ❑ Loosen the screw or screws holding the thermostat to the wallplate and lift the thermostat away.
- ❑ Disconnect the wires from the old thermostat. As you disconnect each wire, attach the enclosed labels with the old terminal designation. If there are only two wires, they do not need to be labeled. Wrap the wires around a pencil as shown to keep them from falling back into the wall.

### Special Installations

Read this section if you are replacing:

- Clock thermostat with separate wires for the clock.
- Thermostat with six or more wires connected to it.
- Thermostat in a heating only system with three wires.

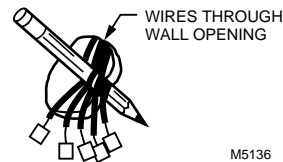

M5136

### Replacing a Clock Thermostat that has C or C1 Clock Terminals

If you are replacing a Honeywell Chronotherm® Thermostat, you may find one or two wires going to the C or C1 clock terminals on the Chronotherm wiring wallplate. Do *not* allow them to touch, or you can damage the transformer. Disconnect the wires and wrap them separately using electrical tape. Do *not* wrap them together. Place the wires where they will not interfere with the operation of the new thermostat. Record the colors and terminal designation labels of the remaining wires.

### Replacing a Thermostat that has Six or More Wires

If there are six or more wires (excluding clock wires attached to terminals), you probably have a variation of a multistage heat pump or other multistage system. This thermostat is not compatible with multistage systems, so return the product to the place of purchase. For information about which programmable thermostats will work with your system, call Honeywell Customer Relations Center, at 1-800-468-1502.

### Replacing a Thermostat that has Three Wires

If you have three wires for a heating only system and can operate the fan using the fan ON switch this thermostat works with your system. However, some hot water (zoned) heating systems also have three wires. Your thermostat will work only if you install an isolating relay on these systems. For details, call your local heating and/or cooling contractor.

## STEP 3. MOUNT THERMOSTAT WALLPLATE

- ❑ Separate the wallplate from the thermostat by placing your thumb or fingers between the bottom of the wallplate and the thermostat, and pulling the wallplate up and away from the thermostat. See illustration at right.
- ❑ Position the wallplate on the wall. Level the wallplate for appearance if desired. Use a pencil to mark the two mounting holes that best fit the application.
- ❑ Remove the wallplate from the wall. Drill two 3/16 in. holes in wall (if drywall) as shown. For materials such as plaster or wood, drill 7/32 in. holes where marked.
- ❑ Reposition the wallplate over the holes. Pull the wires through the wiring opening. Loosely insert mounting screws into each of the holes.
- ❑ Level the wallplate if desired. Thermostat functions properly when not level.
- ❑ Tighten mounting screws.

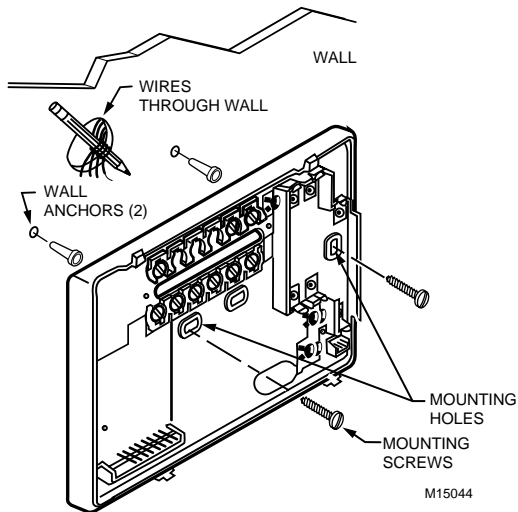
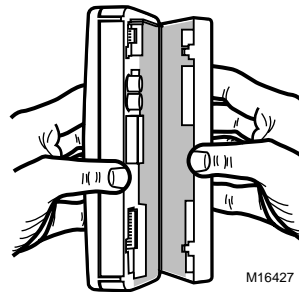

## STEP 4. WIRE WALLPLATE TERMINALS

### IMPORTANT

*All wiring must comply with local codes and ordinances. If unsure about household wiring procedures, call your local heating/air-conditioning contractor.*

Refer to the labels you placed on the wires when you removed the old thermostat (see illustration).

- ❑ Match the letter of your old thermostat wire with the corresponding terminal letter on your new thermostat. Refer to Table 2.
- ❑ Remove the factory-installed jumper connecting terminals R and RC if wires are connected to both of those terminals.
- ❑ For wiring diagrams, if needed, see pp 22-23.
- ❑ Loosen the terminal screws. Slip each wire beneath its matching terminal. Wraparound and straight connections are both acceptable, (see illustration). Tighten the terminals.

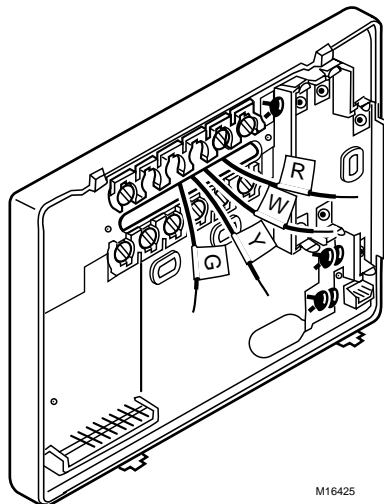
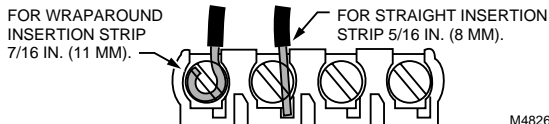

- ❑ Plug the hole in the wall with insulation to help prevent drafts from adversely affecting thermostat operation.



**Table 2. Terminal Designations on Old and New Thermostats**

Terminal on Old Thermostat	Connect To	Description
R, RH <sup>a</sup> , 4, V	R	Power
Rc, R <sup>a</sup>	Rc	Power for cooling
W, W <sub>1</sub> , H	W	Heat
Y, Y <sub>1</sub> , M	Y	Cooling
G, F	G	Fan
O	O	Changeover in cool. (Single stage heat pump only).
B <sup>b</sup>	B <sup>b</sup>	Changeover in heat. (Single stage heat pump only).
C <sup>c</sup> , X <sup>c</sup> , B <sup>b</sup>	Do not connect.	Transformer common
W <sub>2</sub> , H <sub>2</sub>	Do not continue installation. Call 1-800-468-1502.	Second stage heat.
Y <sub>2</sub>		Second stage cool.

<sup>a</sup> If both RH and R terminals are present on existing thermostat, remove jumper and connect Rh to R and R to Rc.

<sup>b</sup> Do not connect both O and B when wiring to a single stage heat pump. Connect O to O. Tape off B.

<sup>c</sup> Tape off end of the wire with electrical tape and push the taped wire back into the wiring hole in the wall.

## STEP 5. INSTALL THE BATTERIES

### IMPORTANT

*Install three AA alkaline batteries. Batteries must be installed for programming and operation of the thermostat and the heating/cooling system.*

- Install the batteries in the wallplate so the positive terminals all point up (see illustration).
- If the thermostat is already mounted on the wall, remove the thermostat by placing your thumb between the thermostat and wallplate and pulling the thermostat up and away as shown.

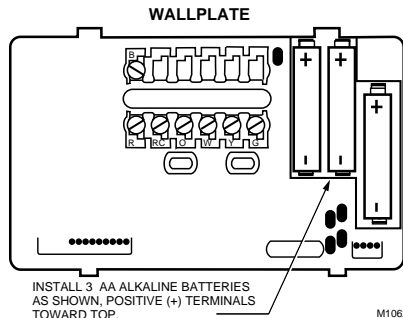

When the batteries are running low, a REPL BAT message flashes for one to two months before the batteries run out completely. Replace the batteries as soon as possible once the message flashes.

### **IMPORTANT**

*Although the thermostat has a low battery indicator, replace the batteries once per year to prevent leakage and to prevent the thermostat and heating/cooling system from shutting down due to lack of battery power in the thermostat.*

If you insert new batteries within 20 to 30 seconds of removing the old batteries, the system retains the current time and day. If the display is blank, the batteries are dead or installed incorrectly. You must reset the time and day. Refer to Set the Clock for instructions.

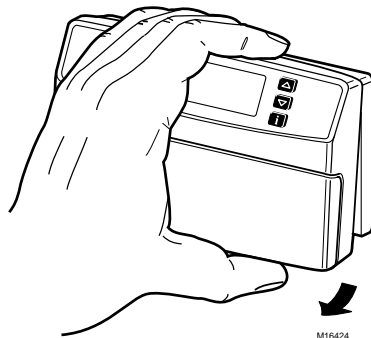

M16424

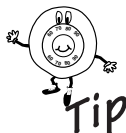

As a precaution when leaving home for longer than a month, change batteries before leaving to prevent the system from shutting down due to lack of power. Always use fresh alkaline batteries. Nonalkaline batteries do not last as long. They also can leak, causing damage to the thermostat and the wall surface.

## **STEP 6. SET FAN OPERATION SWITCH**

The thermostat fan operation switch, labeled FUEL SWITCH is factory set in the F position. This is the correct setting for most systems. If your system is an electric heat system, set the switch to E. The E setting allows the fan to turn on immediately with the heating and cooling in a system where the G terminal is connected.

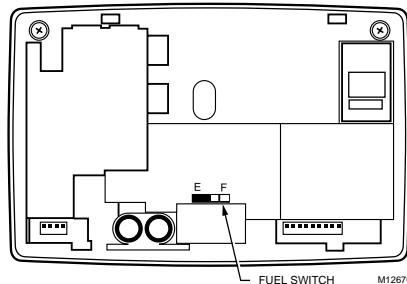

FUEL SWITCH

M12676

## STEP 7. MOUNT THE THERMOSTAT

**A.** ENGAGE TABS AT TOP OF THERMOSTAT AND WALLPLATE.

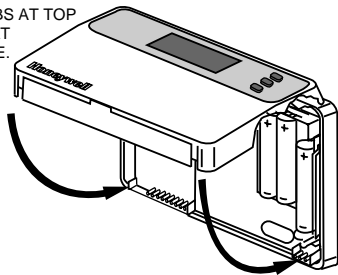

**B.** PRESS LOWER EDGE OF CASE TO LATCH.

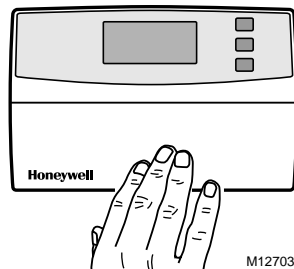

## STEP 8. CUSTOMIZE YOUR THERMOSTAT



Your Honeywell CT3600/CT3697 Thermostat comes preset to the most commonly used settings. The settings are:

- Gas or oil forced air furnace.
- Smart Response technology on.
- Temperature °F.
- 12-hour clock format.

You can change any or all of these settings.

### **IMPORTANT**

*Always press the keys with your fingertip or a similar blunt tool. Sharp instruments like pens and pencil points can damage the keyboard.*

- Press and hold down , , and , simultaneously until the screen shows.  
You now can change any of these settings.

### **System Type (Feature Number 4)**

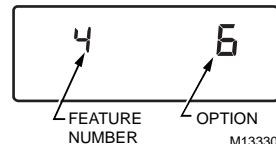

System type options are:

- 1 = Gravity or steam system.



- 3 = Hot water, high efficiency furnace (90% or better), or single stage heat pump.
- 6 = Gas or oil forced air furnace (preset).
- 9 = Electric furnace.

To change your system type:

- Press  until display shows your furnace or boiler type.
- Press Time  to move to next feature or  to return to main display.

### Smart Response™ Technology (Feature Number 13)

Smart Response technology options are:

- 0 = Smart Response technology on (preset).
- 1 = Smart Response technology off.



M13343

To turn Smart Response technology on or off:

- Press  once.
- Press Time  to move to next feature or  to return to main display.

NOTE: See Smart Response technology (page 21) for information about this feature.

### Temperature Format (Feature Number 14)

Temperature format options are:

- 0 = °F (preset).
- 1 = °C.

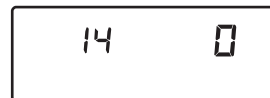

M13344

To change temperature format:

- Press  once.
- Press Time  to move to next feature or  to return to main display.

### Time Format (Feature Number 16)



Time format options are:

- 0 = 12-hour clock (preset).
- 1 = 24-hour clock.



M13345

To change time format:

- Press  once.
- Press  to return to main display.

## Factory Set Function (Feature Number 37)

Do not change this setting.









M13346

# STEP 9. SET THE CLOCK

## Set Current Day and Time

NOTE: On initial power-up, the screen flashes 1:00 pm until you press a key.

- Press .
- Press  until screen shows current day.
- Press Time  or  until screen shows current time. (Tapping the  will advance the time in one hour increments).
- Press  until "DST" displays if daylight savings time is in effect.
- Press .

## STEP 10. PROGRAMMING

The keyboard is located behind the thermostat cover. The three most frequently used keys are near the display.

Pressing **i** displays the current temperature settings. Pressing the **▲** and **▼** keys change the temperature. The thermostat displays day, time, program period, temperature and system settings.

There is an individual key for each of the four program periods:

- Wake** — The program period when you want the house at a comfortable temperature when you get up and while you get ready for work or school. (This is a higher temperature during the heating season and a lower temperature during the cooling season).
- Leave** — The program period you can set for an energy-saving temperature while you are away at work or school. (This is a lower temperature during the heating season and a higher temperature during the cooling season).
- Return** — The program period when you want the house at a comfortable temperature for activities before bedtime. (This is a higher temperature during the heating season and a lower temperature during the cooling season).
- Sleep** — The program period you can set for an energy-saving temperature while you are sleeping. (This is a lower temperature during the heating season and a higher temperature during the cooling season.)

Table 3 can be helpful when planning your schedule of time and temperature settings. The thermostat default settings are shown in parentheses ( ).

**Table 3. Personal Programming Table.**





Period	Default Setting	Monday (Mon)	Tuesday (Tue)	Wednesday (Wed)	Thursday (Thu)	Friday (Fri)	Saturday (Sat)	Sunday (Sun)
Wake	Time (6:00AM)							
	Heat <sup>a</sup> (70°F/21°C)							
	Cool <sup>b</sup> (78°F/25.5°C)							
Leave	Time (8:00AM)							
	Heat <sup>a</sup> (62°F/16.5°C)							
	Cool <sup>b</sup> (85°F/29.5°C)							
Return	Time (6:00PM)							
	Heat <sup>a</sup> (70°F/21°C)							
	Cool <sup>b</sup> (78°F/25.5°C)							
Sleep	Time (10:00PM)							
	Heat <sup>a</sup> (62°F/16.5°C)							
	Cool <sup>b</sup> (82°F/28°C)							

<sup>a</sup> Your heating setpoints cannot be higher than 90°F (32°C) or lower than 40°F (4.5°C).

<sup>b</sup> Your cooling setpoints cannot be higher than 99°F (37°C) or lower than 45°F (7°C).

## Program the First Day

Start by programming the wake time and temperature for one day.

- Press and release .
- Press  until the desired day displays. (Mon, Tue, Wed, Thu, Fri, Sat, Sun)
- Press time  or  until the desired time shows in the display.



NOTE: Program times are in 15 minute intervals. For example, 8:00, 8:15, 8:30.



- ❑ Press  or  until the desired wake temperature displays.

The setpoint temperature range is 40°F to 90°F (4.5°C to 32°C) for heating and 45°F to 99°F (7°C to 37°C) for cooling.

- ❑ Press  to switch between setpoints.

NOTE: Program times are the same for heating and cooling.

- ❑ Press  or  until the display shows the desired temperature setpoint.

- ❑ Press ,  or  and repeat these steps for each program period. The First Day is now programmed.







- ❑ Repeat each step in Program the First Day for the rest of the week.

NOTE: After the first day is programmed, you can copy that day to any other day using procedure in Copy a Day.

- ❑ Press  when the entire week is programmed.

## Copy a Day

Your thermostat can copy program settings from one day to another.

- ❑ Press , ,  or  to enter programming mode.
- ❑ Press  until the display shows the day you want to copy.
- ❑ Press . The display shows.

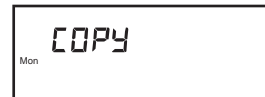

M13327



- ❑ Press  until the display shows the day you want to copy to.

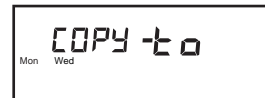

M13328

- ❑ Press  to accept the change.
- ❑ Repeat these steps for each day you want to copy.

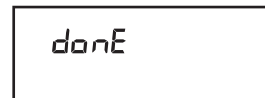









M13329

NOTE: donE appears for two seconds and then the normal program display appears.

## Clear a Program Period

NOTE: Wake cannot be cleared.

- ❑ Press , , or  for the program period you want to clear.
- ❑ Press  until the desired day displays.
- ❑ Press and hold the , , or  for approximately 3 seconds until the time and temperature clear.
- ❑ Repeat the above steps for each period to be cleared.
- ❑ Press .

## STEP 11. OPERATING YOUR THERMOSTAT

### Change Temperature Setting Until the Next Program Period (Temporary Change)

- ❑ Press  or  until the screen shows the desired temperature setting.

NOTE: The temporary temperature setting is displayed for about 3 seconds and then the room temperature is displayed. Temporary appears in the display. The setting cancels when the next program period starts or when you press .

## Change Temperature Setting Indefinitely (Hold)

- ❑ Move the System switch to the desired position (Heat or Cool).
- ❑ Press **Hold Temp** then **▲** or **▼** to change your setting if desired. (The display changes from showing the setpoint temperature to room temperature after approximately three seconds).
- ❑ To cancel "Hold" press **Run Program**.

## Change the Temperature Setting Until a Designated Day and Period (Vacation Hold)

- ❑ Press **Hold Temp** twice.
- ❑ Press **▲** or **▼** until the display shows the desired temperature setpoint.
- ❑ Press Time **▲** until the desired number of days that you will be away (1 through 255) is displayed.
- ❑ Press **Wake**, **Leave**, **Return** or **Sleep** to select the program period when you want the program to restart.

NOTE: If the Vacation Hold needs to be cancelled before the designated time, press **Run Program** to return to the program.



## Daylight Savings Time Key

This feature allows you to switch between standard time and daylight savings time.

- ❑ Press **Daylight Time** during fall to set the time back one hour.
- ❑ Press **Daylight Time** during the spring to set time forward one hour. DST is displayed when operating on daylight savings time.

NOTE: Pressing the Daylight Time key more than once in a five minute period scrolls you through various time options. For example, one hour earlier or later, with or without DST. Pressing Daylight Time six times in a five minute period returns you to your original setting.

## Usage Key

- ❑ Press  once to display the hours and minutes that the heating or cooling system has been operating for the current day.
- ❑ Press  a second time to display the system operating time for the previous day (midnight to midnight).
- ❑ Press  a third time to display the system operating time since the last time the usage function was cleared.

NOTE: Press  for three seconds to clear the usage function.

## STEP 12. SET THE FAN AND SYSTEM SWITCHES

First set the fan switch.

**Fan On:** The fan runs continuously. Use for improved air circulation or for more efficient central air cleaning. (In a heat-only system, fan runs continuously only if fan relay is connected to the G thermostat terminal).

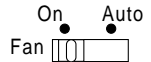

**Fan Auto:** Normal setting for most homes. The equipment controls the fan operation.

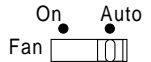

Then set the system switch.

**Heat:** The thermostat controls your heating system.

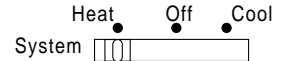

**Off:** Both the heating and air conditioning systems are off.

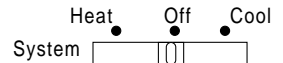

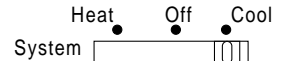

**Cool:** The thermostat controls your air conditioning system.



# IF YOU HAVE A PROBLEM

**Table 4. Solution Guide.**

If...	Then...
Display does not appear.	<ul style="list-style-type: none"> <li>• Make sure the batteries are installed correctly.</li> <li>• Make sure the thermostat is mounted and latched on the wallplate. Mount and latch the thermostat on the wallplate if it is not.</li> </ul>
Temperature settings will not change (example; cannot set the heating higher or the cooling lower).	<ul style="list-style-type: none"> <li>• Make sure the temperature setpoints are: 40 to 90°F (4.5 to 32°C) for heating. 45 to 99°F (7 to 37°C) for cooling.</li> </ul>
Heating does not come on.	<ul style="list-style-type: none"> <li>• Make sure the heating setpoint is above the room temperature.</li> <li>• Make sure the circuit breaker is not tripped, and reset it if necessary.</li> <li>• Make sure the power switch at the equipment is in the On position, and set it to On if it is in the Off position.</li> <li>• Wait five minutes for the system to respond.</li> <li>• Set the system switch to Heat.</li> </ul>
Cooling does not come on.	<ul style="list-style-type: none"> <li>• Make sure the cooling setpoint is below the room temperature.</li> <li>• Make sure the circuit breaker is not tripped, and reset it if necessary.</li> <li>• Make sure the system switch at the air conditioner is in the On position, and set it to On if it is in the Off position.</li> <li>• Wait five minutes for the system to respond.</li> <li>• Set the system switch to Cool.</li> </ul>
System on indicator(  = heat,  = cool) is lit, but no warm or cool air is coming from the registers.	Wait five minutes after seeing the flame or snowflake and check the registers again. If no there is no hot or cool air coming from the registers, refer to Heating does not come on or Cooling does not come on. If all of this has been checked, contact your local heating and cooling contractor.
Display flashes during programming.	The temperature setting limit has been reached. The heating setting range is 40°F to 90°F (4.5°C to 32°C). The cooling setting range is 45°F to 99°F (7°C to 37°C).
Temperature change occurs at the wrong times.	<ol style="list-style-type: none"> <li>1. Check the program times for the period in question.</li> <li>2. Make sure the AM and PM settings are correct.</li> <li>3. Make sure the current time and day settings are correct.</li> <li>4. Reprogram any incorrect settings.</li> </ol> <p>NOTE: If your thermostat is set for Smart Response™ technology, the start times occur before your programmed comfort periods.</p>

## Customer Assistance

Please read and follow the provided instructions for this thermostat. For additional information, go to [www.honeywell.com/yourhome](http://www.honeywell.com/yourhome) or call our 24-hour automated information line at 1-800-468-1502.

Before calling, please have the following information available:

- Thermostat model number. (Located on back of thermostat).
- Thermostat date code. (Located below model number).
- Type of heating/cooling system (for example, hot water, warm air, oil, or gas).
- Location and number of wires connected to the thermostat.

## SMART RESPONSE™ TECHNOLOGY

Your CT3600/CT3697 is actually a small computer. The Smart Response technology calculates the correct time of day to turn on your heating or cooling system. Smart Response technology considers the following information.

- Air temperature.
- Wall temperature.
- The time of day when you want the comfort temperature established.

When the thermostat activates Smart Response technology, the thermostat displays **In Recovery**, changes the setpoint, and turns on the system.

- Your CT3600/CT3697 Thermostat learns from experience. Each day it checks how closely it hit the recovery target and then adjusts the next day's recovery start time accordingly.
- It takes a few days after installation for the thermostat to adjust to the local weather, your lifestyle, the construction of your home, and your heating/cooling system.
- You can turn off Smart Response technology by selecting Conventional Recovery. See Step 8. Customize Your Thermostat.

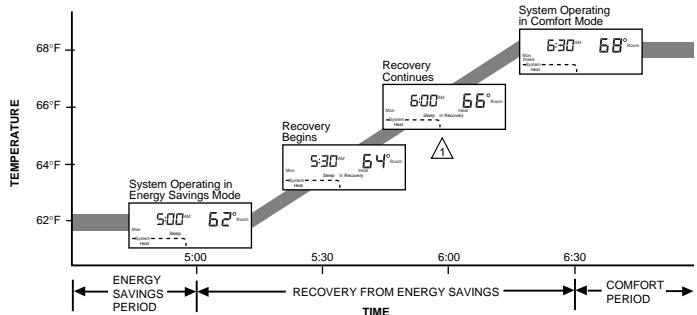

Thermostat uses the same scheme to return to lower comfort temperature during the cooling season.

⚠ IF In Recovery IS DISPLAYED, PRESS  TO SEE THE COMFORT SETPOINT.

M18591

# WIRING DIAGRAMS

### 2-WIRE HEAT-ONLY (JUMPER INTACT)

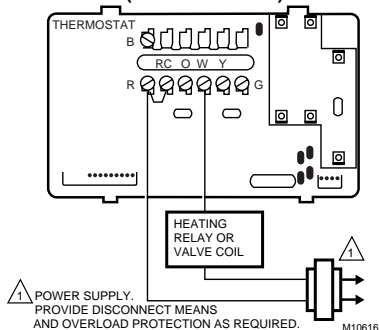

### 4-WIRE HEAT/COOL (JUMPER INTACT)

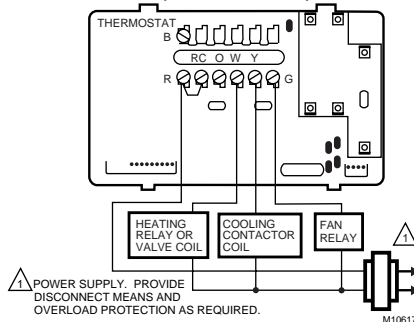

### 3-WIRE HEAT ONLY WITH FAN (JUMPER INTACT)

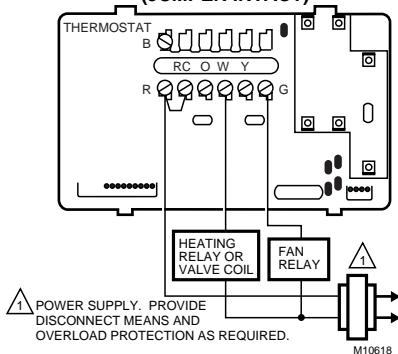

### 4-WIRE SINGLE-STAGE HEAT PUMP (JUMPER INTACT)

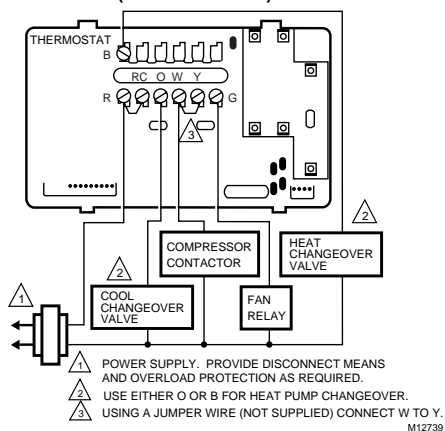

### 5-WIRE HEAT/COOL (JUMPER REMOVED)

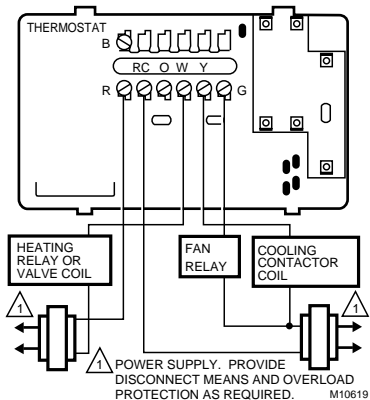

### 5-WIRE HEAT/COOL WITH DAMPER (JUMPER INTACT)

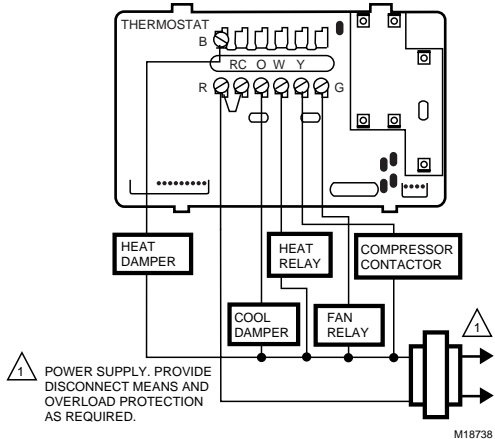

## Notice:

This thermostat is a Class B digital apparatus that complies with Canadian Radio Interference Regulations, CRC c. 1374.

## Limited One-Year Warranty

Honeywell warrants this product, excluding battery, to be free from defects in the workmanship or materials, under normal use and service, for a period of one (1) year from the date of purchase by the consumer. If, at any time during the warranty period, the product is defective or malfunctions, Honeywell shall repair or replace it (at Honeywells option) within a reasonable period of time.

If the product is defective,

- (i) return it, with a bill of sale or other dated proof of purchase, to the retailer from which you purchased it, or
- (ii) package it carefully, along with proof of purchase (including date of purchase) and a short description of the malfunction, and mail it, postage prepaid, to the following address:

Honeywell USA  
Dock 4 — MN10-3860  
1885 Douglas Drive North  
Golden Valley, MN 55422-3992

Honeywell Canada:  
Honeywell Limited/Honeywell Limitée  
35 Dynamic Drive  
Scarborough, Ontario M1V 4Z9

This warranty does not cover removal or reinstallation costs. This warranty shall not apply if it is shown by Honeywell that the defect or malfunction was caused by damage which occurred while the product was in the possession of a consumer.

Honeywells sole responsibility shall be to repair or replace the product within the terms stated above. HONEYWELL SHALL NOT BE LIABLE FOR ANY LOSS OR DAMAGE OF ANY KIND, INCLUDING ANY INCIDENTAL OR CONSEQUENTIAL DAMAGES RESULTING, DIRECTLY OR INDIRECTLY FROM ANY BREACH OF ANY WARRANTY, EXPRESS OR IMPLIED, OR ANY OTHER FAILURE OF THIS PRODUCT. Some states do not allow the exclusion or limitation of incidental or consequential damages, so this limitation may not apply to you.

THIS WARRANTY IS THE ONLY EXPRESS WARRANTY HONEYWELL MAKES ON THIS PRODUCT. THE DURATION OF ANY IMPLIED WARRANTIES, INCLUDING THE WARRANTIES OF MERCHANTABILITY AND FITNESS FOR A PARTICULAR PURPOSE, IS HEREBY LIMITED TO THE ONE YEAR DURATION OF THIS WARRANTY. Some states do not allow limitations on how long an implied warranty lasts, so the above limitation may not apply to you.

This warranty gives you specific legal rights, and you may have other rights which vary from state to state.

If you have any questions concerning this warranty, please write Honeywell Customer Relations, 1885 Douglas Dr. N., Golden Valley, MN 55422-3992. In Canada, write Retail Products ON30 Honeywell Limited/Honeywell Limitée, 35 Dynamic Drive, Scarborough, Ontario M1V 4Z9.

# Honeywell

---

### Automation and Control Solutions

Honeywell  
1985 Douglas Drive North  
Golden Valley, MN 55422

Honeywell Limited-Honeywell Limitée  
35 Dynamic Drive  
Scarborough, Ontario  
M1V 4Z9



Printed in U.S.A. on recycled  
paper containing at least 10%  
post-consumer paper fibers.

69-1642 G.H. 7-02

Download from [www.Somanuals.com](http://www.Somanuals.com). All Manuals Search And Download.

[www.honeywell.com/yourhome](http://www.honeywell.com/yourhome)



## Free Manuals Download Website

<http://myh66.com>

<http://usermanuals.us>

<http://www.somanuals.com>

<http://www.4manuals.cc>

<http://www.manual-lib.com>

<http://www.404manual.com>

<http://www.luxmanual.com>

<http://aubethermostatmanual.com>

Golf course search by state

<http://golfingnear.com>

Email search by domain

<http://emailbydomain.com>

Auto manuals search

<http://auto.somanuals.com>

TV manuals search

<http://tv.somanuals.com>