

CT2700 An Electronic Round™ Programmable Thermostat

USER'S GUIDE



**Programmable Heat and/or Cool
Low Voltage (20 to 30 Vac) Thermostat and Wallplate
Model CT2700**

Congratulations on the purchase of your new thermostat! Over 100 years of Honeywell engineering expertise went into the making of this thermostat in an effort to provide you with a more comfortable and convenient living environment.

Your new thermostat will automatically control the temperature in your home, keeping you comfortable while saving energy when programmed according to the instructions in this manual.

Direct any questions concerning the application of this thermostat to Honeywell Customer Assistance at 1-800-468-1502, Monday - Friday 7:00 a.m. - 5:30 p.m., Central time.

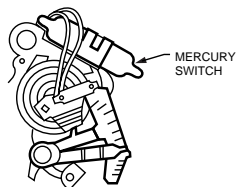

**TYPICAL LOCATION OF A MERCURY
SWITCH IN A THERMOSTAT**

M10614



RECYCLING THERMOSTAT

If this thermostat is replacing a control that contains mercury in a sealed tube, do *not* place your old control in the trash. Contact your local waste management authority for instructions regarding recycling and the proper disposal of this control, or of an old control containing mercury in a sealed tube.

If you have questions, call Honeywell, Inc. at 1-800-468-1502.

1 PREPARE FOR INSTALLATION

- Check Table 1 to make sure this thermostat is compatible with your system. If not, return to the retailer. For more information, call Honeywell, Inc. at 1-800-468-1502.



Table 1. Compatibility Chart

System Type	Compatible With CT2700
Gas—Standing Pilot	Yes ^a
Gas—Electronic Ignition	Yes
Gas-Fired Boilers	Yes ^{a,b}
Gas—Millivolt	No
Oil-Fired Boilers	Yes ^b
Oil-Fired Furnace	Yes
Electric Furnace	Yes
Electric Air Conditioning	Yes
Baseboard Electric (120/240 Line Volt)	No
Heat Pumps/Multistage Equipment	No

Not compatible with any 120/240 volt circuit.

Not compatible with 2-wire White-Rodgers no. 1361 zone valves.

^aNot compatible with millivolt systems.

^bCompatible with 2-wire Honeywell zone valves. Isolating relay required for 3-wire thermostats zone valves

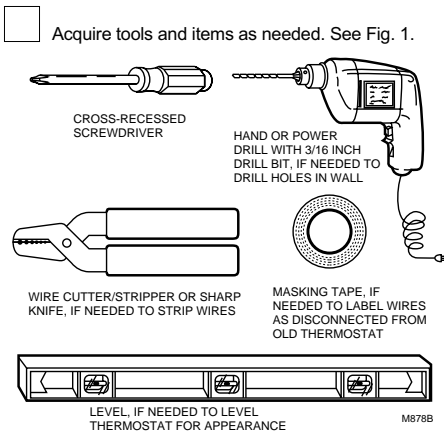

Fig. 1. Required installation tools/supplies.

2 REMOVE OLD THERMOSTAT

Test to make certain that your heating and air conditioning systems (where applicable) are working properly. If either does not work, contact your local heating/air conditioning dealer. To avoid compressor damage, do not operate the cooling system when outdoor temperature is below 50°F (10°C).

CAUTION

Be careful when handling wires during installation.

Damage to heating/cooling system possible. Disconnect power at furnace or at main breaker/fuse box before starting operation.

Carefully unpack your new thermostat, wallplate, and decorator cover plate; save package of screws, instructions and receipt.

Remove the cover from the old thermostat. If it does not snap off when pulled firmly from the bottom, check for a screw used to lock on the cover.

Loosen screws holding thermostat to subbase, wallplate, to wall and lift away.

Disconnect wires from old thermostat or subbase. As you disconnect each wire, use masking tape to label it with the old terminal designation. If there are only two wires, they do not need labeling. Wrap wires around a pencil to keep them from falling back into the wall as shown in Fig. 2.

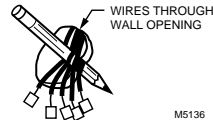

Fig. 2. Wrapping wires around pencil.

Replacing Clock With C or C1 Clock Terminals

If you are replacing a Honeywell Chronotherm® Thermostat, you may find one or two wires that go to the C or C1 clock terminals on the Chronotherm® Thermostat wiring wallplate. Do not allow them to touch, or you can damage your transformer. Disconnect the wires and wrap them separately using electrical tape; do not wrap them together. Place the wires to avoid interfering with the new thermostat operation. Record the colors and terminal designation labels of the remaining wires.

Six or More Wires

If there are six or more wires connected to the thermostat (excluding clock wires attached to terminals), you probably have a variation of a multistage heat pump or other multistage system. The thermostat is not compatible with such systems so return the product to your retailer. If you would like information about which programmable thermostats work with your system, call Honeywell Customer Assistance Center at 1-800-468-1502.

Three Thermostat Wires

If you have three wires for heating only and can operate the fan using the FAN ON switch, this thermostat works with your system. However, some hot water (zoned) heating systems have three thermostat wires. The thermostat will work only if you install an isolating relay on these systems. For details, call Honeywell Customer Assistance Center at 1-800-468-1502.

3 MOUNT WALLPLATE

IMPORTANT

Level for appearance only. The thermostat functions normally even when not mounted level.

Position the decorator cover plate and wallplate on the wall. Level the wallplate for appearance if desired. Use a pencil to mark the two mounting holes that best fit the application. See Fig. 3.

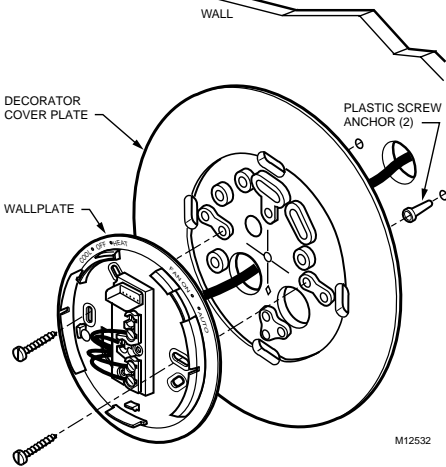

Fig. 3. Mounting decorator cover plate and wallplate to wall.

Remove the decorator cover plate and wallplate from the wall, and drill two 3/16-inch holes in the wall (if drywall). For firmer wall material such as plaster or wood, drill 7/32-inch holes. Gently tap provided anchors into the drilled holes until flush with the wall.

Reposition the decorator cover plate and wallplate, pulling wires through the wiring opening. Loosely insert the mounting screws into the holes.

Level for appearance only; the thermostat functions properly even when not level. Tighten the mounting screws.

4 WIRE WALLPLATE TERMINALS

The CT2700 Thermostat is powered through the heating/cooling system and is adaptable to most 4-wire, 18 to 30 Vac heating-cooling systems. Refer to Figs. 4 through 6 for some typical system wiring diagrams.

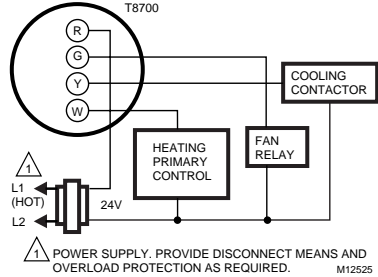

Fig. 4. CT2700 wiring diagram, 4-wire heat/cool system.

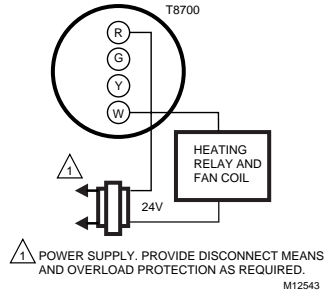

Fig. 5. CT2700 wiring diagram, 2-wire, heat-only system.

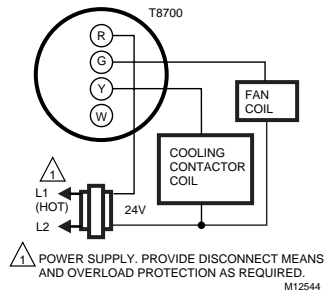

Fig. 6. CT2700 wiring diagram, 3-wire, cool-only system.

IMPORTANT

Use 18-gauge maximum wire to wire the thermostat.

All wiring must comply with local electrical codes and ordinances. If unsure about household wiring procedures, call your local heating and air conditioning contractor.

Refer to the masking tape labels you placed on wires when you removed your old thermostat.

Match the letter of your old thermostat wire with the terminal of the corresponding letter on your new thermostat. Refer to Fig. 7.

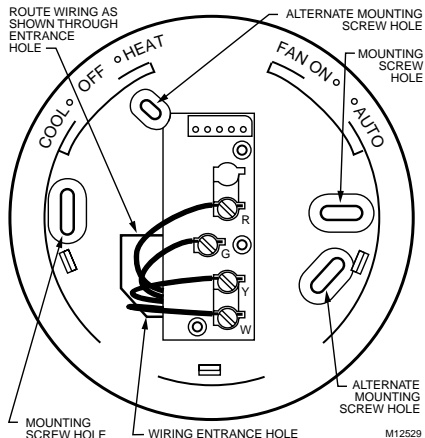

Fig. 7. CT2700 wallplate wiring connections.

NOTE: To ensure proper mounting of the thermostat, restrict all wiring to the left side of the terminals.

Loosen the terminal screws and slip each wire beneath its matching terminal. The shape of the terminals permit insertion of straight or wraparound connections. See Fig. 8. Tighten the terminals.

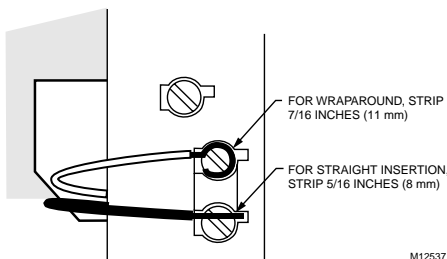

Fig. 8. CT2700 methods for wiring connection.

Plug the hole in the wall with insulation to help prevent drafts from adversely affecting thermostat operation.

5 ADJUST FAN OPERATION SWITCH

The thermostat fan operation switch, labeled fuel switch in Fig. 9, is set at the factory in the F (gas/oil fuel) position. This is the correct setting for most systems. If this system is an electric heat system, set the switch to the E (electric) position. The E setting allows the fan to turn on immediately with the heating or cooling equipment in a system where the G terminal is connected.

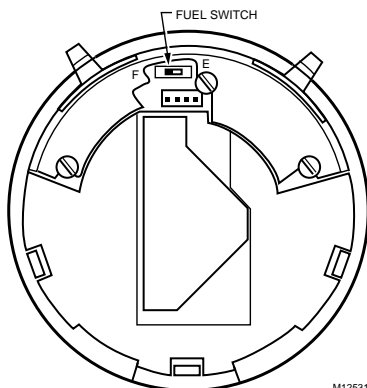

Fig. 9. Fuel switch, rear view of thermostat.

6 MOUNT THERMOSTAT TO WALLPLATE

Align the tab and connector pins at the top of the thermostat with the wallplate. See Fig. 10.

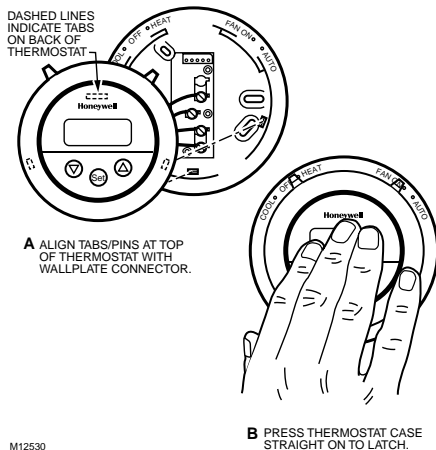

Fig. 10. Mounting thermostat to wallplate.

Press the thermostat straight on to the wallplate to latch.

NOTE: To remove the thermostat from the wallplate, grasp the thermostat on both sides and pull the thermostat straight out.

Restore power to the heating/cooling system.

7 PROGRAM YOUR THERMOSTAT

The thermostat is preprogrammed for your convenience with the following time and temperature settings, see Table 2.

Table 2. Preprogrammed Time/Temperature Settings.

Period	Start Time	Heating Setpoint	Cooling Setpoint
WAKE	6:00 AM	70°F (21°C)	78°F (25.5°C)
SLEEP	10:00 PM	62°F (16.5°C)	82°F (28°C)

WAKE is the time period you want the house at a comfortable temperature during the day.



SLEEP is the time period you can set for an energy-savings temperature while you are sleeping.

NOTE: The heating and cooling program times are the same. Changing your cooling WAKE time also changes your heating WAKE time.

The following sequence uses the heating program as an example; the System switch is in the HEAT position. To change to the cooling program, move the System switch to the COOL position and enter the cooling temperature settings.

NOTE: To exit the sequence at any time, press  until End is displayed.



1. Set Current Time

- Press .
- Press  or  to set current time.





If you wish to change the preprogrammed time/temperature settings, follow steps 2 through 6. If not, press the  key until End is displayed or the thermostat will automatically return to normal operational mode within five minutes.

2. Set WAKE Time

- Press .
- Press  or  to set desired WAKE time.



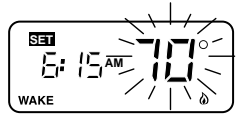

3. Set WAKE Temperature

- Press .
- Press  or  to set desired WAKE temperature.





4. Set SLEEP Time

- Press .
- Press  or  to set desired SLEEP time.



5. Set SLEEP Temperature

- Press .
- Press  or  to set desired SLEEP temperature.



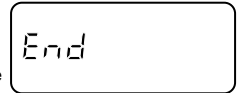

6. Run Program

Press . End is displayed for five seconds indicating the end of programming. The thermostat then displays the current time and room temperature.





8 OPERATE YOUR THERMOSTAT

Display Temperature Setting

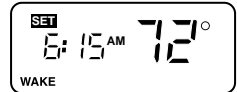
- Press  or  once to display present temperature setting. After approximately five seconds, the thermostat displays the current time and room temperature.



Temporary Change

- Press  or  until the desired temperature is displayed.
- TEMPORARY is displayed. The TEMPORARY change is in effect until the next program period.

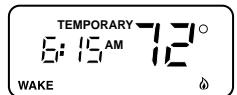

NOTE: To cancel your TEMPORARY change, press  until End is displayed.

Hold Function

To hold the thermostat at one temperature indefinitely, program both WAKE and SLEEP to the same temperature.

9 SET FAN AND SYSTEM SWITCHES

Manually control fan and system settings using the switches located at the top of the thermostat case. See Fig. 11 for switch locations.

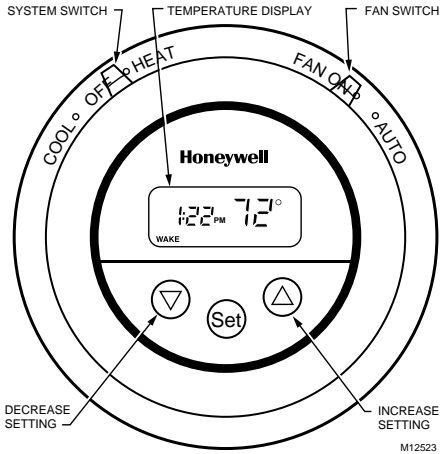

Fig. 11. CT2700 time/temperature display and system/fan switches.

Fan Switch

- The FAN switch settings are:
ON: The fan runs continuously. Use for improved air circulation.
AUTO: Normal setting for most homes. In cooling, the fan starts and stops with the cooling equipment. In heating, the fan is controlled directly by the heating equipment and starts a few minutes after the heating equipment turns on (on most systems). When the thermostat fuel switch is set to the E position for electric heat, the fan starts and stops with the heating equipment.

Slide the switch on the thermostat to the desired fan setting.

System Switch

- The System switch settings control thermostat operation as follows:
COOL: The thermostat controls the cooling system.
OFF: Both heating and cooling are off.
HEAT: The thermostat controls the heating system.
- Slide the System switch on the thermostat to the desired system setting.

10 CHECK OPERATION AFTER INSTALLATION/PROGRAMMING

Heating System

- Slide the System switch to HEAT and the Fan switch to AUTO.
- Press and hold the Δ key to raise the temperature several degrees above the room temperature to start the heating equipment. When using the thermostat with the fuel switch set to the E position for electric heat, the fan starts immediately.
- Press the ∇ key to lower the temperature setting below the room temperature. The heating equipment should stop.

Cooling System



CAUTION

Operating at too low of an outdoor temperature may cause compressor damage. Damage to compressor possible.

Do not operate cooling system if outdoor temperature is below 50°F (10°C). Refer to manufacturer recommendations.

IMPORTANT

Temporary protection delay protects compressor; the thermostat allows the compressor to remain off for five minutes before restarting.

- Slide the System switch to COOL and the Fan switch to AUTO.
- Press the ∇ key to lower the temperature setting several degrees below the room temperature to start the cooling equipment.
- Press the Δ key to raise the temperature setting above the room temperature. The cooling equipment should shut down.

Fan

- Slide the System switch to OFF and the Fan switch to ON. The fan should run continuously.

CUSTOMIZE YOUR THERMOSTAT

The following instructions provide the information necessary to change the heating cycle rate to match your heating equipment; choose Fahrenheit (°F) or Celsius (°C); and 12- or 24-hour clock.

To exit at any time, press Set until End is displayed.

1. Enter Installer Setup

- a. Slide System switch to OFF position.
- b. Use the ∇ or Δ keys to set the temperature setpoint to 52°F (11°C).

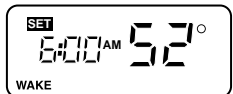

- c. After the thermostat reverts back to displaying room temperature (approximately five seconds), simultaneously press ∇ and \triangle keys and hold for three seconds. Release the keys after the display changes.
- d. Press Ⓢ within five seconds. The display changes to show current cycle rate setting.

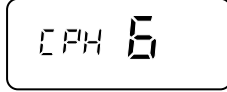
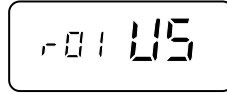

2. Cycles Per Hour

- a. Use ∇ or \triangle to select 1, 3, 6, or 9 cycles per hour (cph). Refer to Table 3.

Table 3. Heating Cycle Rates

System	Program Setting (cph)
Gas or oil forced air	6
Electric furnace	9
Hotwater baseboard, High efficiency (90+) gas furnace	3
Steam, radiant floor heat, gravity	1

- b. Press Ⓢ to display the current °F or °C setting.

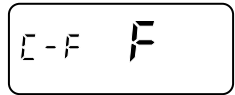

3. Fahrenheit - Celsius Temperature

- a. Use ∇ or \triangle to choose between °C and °F.
- b. Press Ⓢ to display the current 12- or 24-hour clock setting.

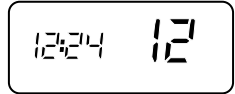

4. Clock Format

- a. Use ∇ or \triangle to choose either a 12- or 24-hour clock format.

Press Ⓢ once to exit the Installer Setup. Upon exiting, the temperature setting will be at 52°F (11°C). Pressing Ⓢ six times returns the thermostat to the normal operational mode. End appears in the display.

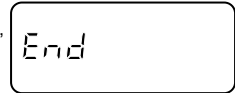

5. Slide system switch to desired position.

TROUBLESHOOT YOUR THERMOSTAT

Symptom	Possible Cause	Corrective Action
Heating/cooling equipment will not operate	No AC power to thermostat.	Check power to heating/cooling equipment: — On/Off switch — Fuse or circuit breaker — Loose 24V connection: At thermostat; at furnace/air conditioner — Incorrect wiring: check appropriate wiring diagram.
	Thermostat inoperative.	See checkout section.
	System switch on thermostat in wrong position.	Reset System switch.
	Thermostat minimum-off times operating for cooling.	Wait five minutes or follow steps in Checkout section.
	Incorrect wiring.	Check wiring.
Partial display	Heating/cooling equipment inoperative.	Consult equipment manufacturer instructions.
	Inoperative thermostat.	Replace thermostat.
No display	Still in installer setup mode.	See Installer Setup section for exit instructions.
	No power to thermostat.	Check power to thermostat.
Temperature display is incorrect	Thermostat mounted incorrectly on wallplate.	See installation instructions for correct mounting.
	Thermostat is configured for °F or °C.	Reconfigure the display. See Installer Setup section for instructions to change the display.
Cannot change temperature setting	The upper or lower temperature limits were reached.	Check the temperature setpoints; temperature setting range is 40°F (4°C) to 99°F (37°C).

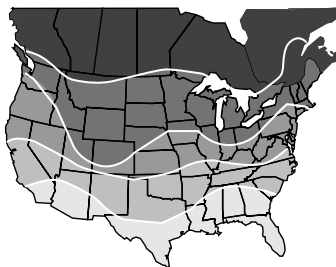

PERCENT OF HEATING COSTS YOU CAN SAVE

SAVINGS FOR ONCE-A-DAY 10°F (5°C) DECREASE*

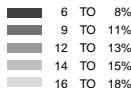

HEAT

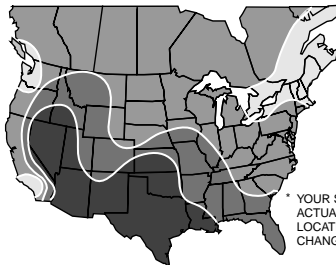

PERCENT OF COOLING COSTS YOU CAN SAVE

SAVINGS FOR ONCE-A-DAY 10°F (5°C) INCREASE*

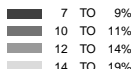

COOL

* YOUR SAVINGS DEPENDS ON HOME SIZE AND ACTUAL HEAT LOSS OR GAIN, GEOGRAPHIC LOCATION, FREQUENCY OF TEMPERATURES CHANGE, AND RANGE IN DEGREES OF CHANGE.

M12545

Limited One-Year Warranty

Honeywell warrants this product to be free from defects in the workmanship or materials, under normal use and service, for a period of one (1) year from the date of the purchase by the consumer. If, at any time during the warranty period, the product is defective or malfunctions, Honeywell shall repair or replace it (at Honeywell's option) within a reasonable period of time.

If the product is defective,

- (i) return it, with a bill of sale or other dated proof of purchase, to the retailer from which you purchased it, or
- (ii) package it carefully, along with proof of purchase (including date of purchase) and a short description of the malfunction, and mail it, postage prepaid, to the following address:

Honeywell, Inc.
Return Goods Department
1050 Berkshire Lane
Plymouth, MN 55441-4437

in Canada:

Honeywell, Limited/Honeywell Limitée
Product Services ON15-FFE
155 Gordon Baker Road
North York, Ontario M2H 3N7

This warranty does not cover removal of reinstallation costs. This warranty shall not apply if it is shown by Honeywell that the defect or malfunction was caused by damage which occurred while the product was in the possession of a consumer.

Honeywell's sole responsibility shall be to repair or replace the product within the terms stated above. Honeywell shall not be liable for any loss or damage of any kind, including any incidental or consequential damages resulting, directly or indirectly, from any breach of any warranty, expressed or implied, or any other failure of this product. Some states do not allow the exclusion or limitation or incidental or consequential damages, so this limitation may not apply to you.

This warranty is the only expressed warranty Honeywell makes on this product. The duration of any implied warranties, including the warranties of merchantability and fitness for a particular purpose is hereby limited to the one year duration of this warranty. Some states do not allow limitations on how long an implied warranty lasts, so the above limitation may not apply to you.

This warranty gives you specific legal rights, and you may have other rights which vary from state to state.

If you have any questions concerning this warranty, please write our Customer Assistance Center, Honeywell, Inc., P.O. Box 524, Minneapolis, MN 55440-0524, Monday - Friday, 7:00 a.m. to 5:30 p.m., Central time. In Canada, write Retail Products ON15-02H, Honeywell Limited/Honeywell Limitée, 155 Gordon Baker Road, North York, Ontario M2H 3N7.

Honeywell

Home and Building Control

Honeywell Inc.
Honeywell Plaza
P.O. Box 524
Minneapolis, MN 55408-0524

Home and Building Control

Honeywell Limited-Honeywell Limitée
155 Gordon Baker Road
North York, Ontario
M2H 3N7

Helping You Control Your World®

Free Manuals Download Website

<http://myh66.com>

<http://usermanuals.us>

<http://www.somanuals.com>

<http://www.4manuals.cc>

<http://www.manual-lib.com>

<http://www.404manual.com>

<http://www.luxmanual.com>

<http://aubethermostatmanual.com>

Golf course search by state

<http://golfingnear.com>

Email search by domain

<http://emailbydomain.com>

Auto manuals search

<http://auto.somanuals.com>

TV manuals search

<http://tv.somanuals.com>