



## 96d Controller Unit



---

**Controller Unit**

**96d**  
**User Manual**

M-511401  
8/10



# Notices and Trademarks

**Copyright by Honeywell International Inc.  
August 2010**

While this information is presented in good faith and believed to be accurate, Honeywell disclaims the implied warranties of merchantability for a particular purpose and makes no express warranties except as may be stated in its written agreement with and for its customers.

In no event is Honeywell liable to anyone for any indirect, special or consequential damages. The information and specifications in this document are subject to change without notice.

This manual covers software version 3.086.





Honeywell Analytics  
405 Barclay Boulevard  
Lincolnshire, Illinois 60069



---

# Symbol Definitions

The following table lists the symbols used in this document to denote certain conditions:

Symbol	Definition
	<b>ATTENTION:</b> Identifies information that requires special consideration
	<b>TIP:</b> Identifies advice or hints for the user, often in terms of performing a task
	<b>REFERENCE _ INTERNAL:</b> Identifies an additional source of information within the bookset.
<b>CAUTION</b>	Indicates a situation which, if not avoided, may result in equipment or work (data) on the system being damaged or lost, or may result in the inability to properly operate the process.
	<b>CAUTION:</b> Indicates a potentially hazardous situation which, if not avoided, may result in minor or moderate injury. It may also be used to alert against unsafe practices. <b>CAUTION:</b> Symbol on the equipment refers the user to the product manual for additional information. The symbol appears next to required information in the manual.
	<b>WARNING:</b> Indicates a potentially hazardous situation which, if not avoided, could result in serious injury or death. <b>WARNING</b> symbol on the equipment refers the user to the product manual for additional information. The symbol appears next to required information in the manual.





---

<b>INTRODUCTION .....</b>	<b>9</b>
Intended Use .....	9
Receiving and Unpacking.....	9
Installation Instructions .....	10
Basic Guidelines .....	10
Surface Mount Installation .....	11
Wiring Details .....	12
Power Connections .....	14
Communication Connections .....	14
Settings for Specific Transmitters .....	14
Relay Output .....	15
Jumper Use Instructions.....	16
<b>GETTING STARTED .....</b>	<b>17</b>
Initial Startup .....	17
Datalogger (SDcard) .....	17
Programming Interface.....	18
Keypad Functions.....	18
LED Definitions .....	19
System Operation .....	19
<b>SYSTEM PROGRAMMING .....</b>	<b>20</b>
Tx Info Menu .....	23
Ident Menu .....	24
Product and Sensor Types .....	26
COM Menu .....	27
Scale Menus (1 and 2) .....	28
Detection Menu .....	29
Display Menu .....	30
Alarm A, B and C Menus .....	31
Servicing and Operating Menus .....	32
Status Code.....	33
Erase Current Tx .....	33
Change Tx Address .....	34
Groups Menu.....	35
Creating Groups .....	36
Deleting Groups .....	37

---

Event Menu .....	38
Action Menu .....	40
Delays Menu .....	41
Latch Mode .....	42
Conditions .....	43
Status .....	47
Database .....	47
Acquisition Menu .....	48
Starting and Stopping Tx Logging .....	49
Starting and Stopping Event Logging .....	50
Copy Menu .....	51
Configuration .....	51
Parameters .....	52
System Log Menu .....	53
Config Menu .....	54
Network Menu .....	59
Remote Calibration .....	61
Tests Menu .....	63
Test Sequence .....	65
Normal Mode .....	67
Single Tx Mode .....	67
Debug Mode .....	67
Simulation Mode .....	68
BACnet Menu .....	69
Wireless Network Menu .....	70
Specifications .....	71
<b>WARRANTY .....</b>	<b>73</b>
Warranty Statement .....	73
Warranty Conditions .....	73
Consumer Claims .....	74





## Introduction

The 96D controllers act as nerve centers for gas detection networks, providing continuous monitoring for up to 96 connected units (plus 1 301ADI). Since the controllers are factory programmed to the owner's specifications, installation is limited simply to mounting and connecting them. Once installed and connected, the controllers allow the user to monitor, adjust, or reconfigure an entire network of units.

### Intended Use

The controller is intended to monitor an entire gas detection network around the clock. The unit offers logging capabilities, creating log files of all transmitter concentrations and alarms for analysis. The unit is also equipped with grouping or zoning capabilities that allow users to query and monitor specific groups of transmitters or specific transmitter zones.

### Receiving and Unpacking

Upon receiving the controller unit:

- Check that the package is undamaged
- Carefully open the package.
- Locate the packing slip or purchase order and verify that all items on the order are present and undamaged

*Note: If the package or any of its contents are damaged, please refer to the Warranty section at the back of the manual for instructions.*

## **Installation Instructions**

### **Basic Guidelines**

Follow these instructions to the letter to ensure that the equipment will function properly. Failure to respect these guidelines will release Honeywell Analytics from any responsibility in the event of improper functioning:

- Locate all units in areas easily accessible for service.
- Avoid locations where instruments are subject to vibrations
- Avoid locating units near sources of electromagnetic interference
- Avoid locating units in areas subject to significant temperature swings
- Verify local requirements and existing codes that may impact choice of location.

## Surface Mount Installation

It is recommended that controllers be installed 5 feet (1.5 m) above the floor, at approximate eye level.

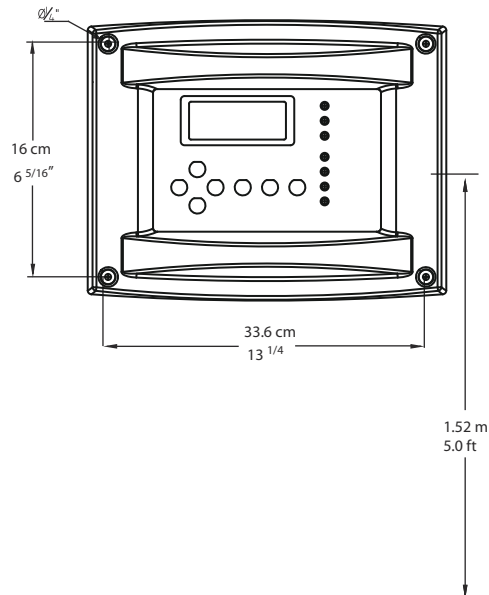

Mark the holes as shown:

- Height markers 6 13/32" apart
- Width markers 10 9/16" apart
- Pre-drill 1/4" mounting holes as needed
- Securely mount the 96D using the appropriate screws

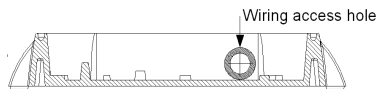

Wiring for the unit must be passed through the knock-outs provided at the bottom of the unit.

# Wiring Details

The diagram below provides the details required to connect the 96d to a gas detection network.

Details concerning power supply, cables, capacities, etc., are provided in the Specifications section at the back of this manual.

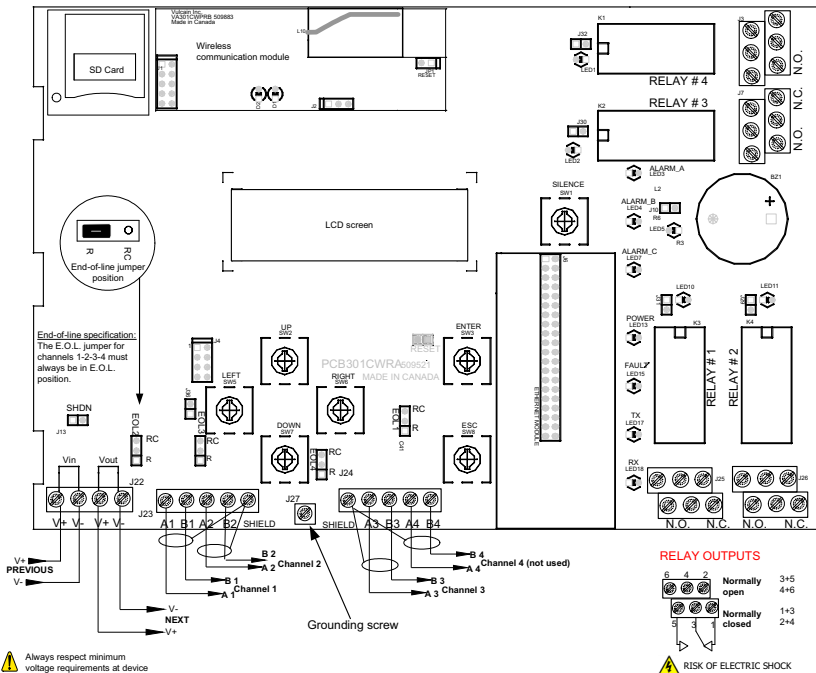

- ⚠ Always respect minimum voltage requirements at device
- ⚠ RISK OF ELECTRIC SHOCK

**COMMUNICATION**

**Communication Wire Gauge:**  
2-24 AWG (Belden 9841)  
Twisted and shielded cable  
2000 feet (600 m) per channel  
†Frac: 60 feet (20 m) / 1 Tap  
130 feet (40 m) total

**Channel Specifications:**  
Channel 1-2: Modbus/Vulcan protocol  
Channel 3: Modbus protocol only  
Communicates only with Vulcan transmitters

**Wireless Communication:**  
ISM worldwide  
Indoor range 30m

**BacNet/IP MODULE (-BIP option)**

Ethernet: 10/100-compatible with 10Base-T interface, RJ-45

Visual Indicators:  
Green LED LINK  
Yellow LED ACT



The connectors, or ports, on the PCB allow various wiring to be connected to the controller. The wiring includes power, communication, BACNet and relays, each with an assigned position (and number) on the board:

- J22 Power Input: Connect the power supply to the controller (see Wiring Details for cabling diagrams)
- J23, J24 Communication inputs: Connect communication cables to channels 1 through 3.
- Relay Outputs 1-4: Depending on the desired configuration, connect the relay cables to either N.O. or N.C.
- SHDN jumper Place the jumper over the Shutdown header pins to reset or restart the system.
- EOL Resistors 1-4: Place the jumper over the header pins to create the connection to attenuate communication echoes.

## Power Connections

The 96D requires a power range of 17-27 Vac, 50/60 Hz (8.64 VA), 18-36 Vdc, 350 mA @24 Vdc (8.4 VA). Polarization is not important in either AC or DC mode. The system must be grounded on the transformer and a dedicated circuit breaker must be used.

## Communication Connections

Communication cables must be grounded using the shield terminal, using twisted and shielded pair Belden 2-24 AWG #9841 cable (or equivalent).

The network cabling can extend up to a limit of 2000 feet (609 m) per channel.

The length of a T-tap can reach 65 feet (20 m), up to a maximum of 130 feet (40 m) for all T-taps.

All wireless devices associated to the controller will automatically be detected and communicate with the controller using wireless communication protocols.

## Settings for Specific Transmitters

Honeywell Sensepoint XCD Transmitters must be configured for 9600 baud, no parity, and a unique address. Honeywell XNX Universal Transmitters must be configured for 9600 baud and a unique address. Information on configuring each transmitter is in the associated technical manual.

## Relay Output

The relay output can withstand up to 5A at 30Vdc or 250Vac (resistive load only). Relays can be used to activate horns and strobes. Although each relay is programmed with a default setting (below), they can be configured using the controller programming menu.

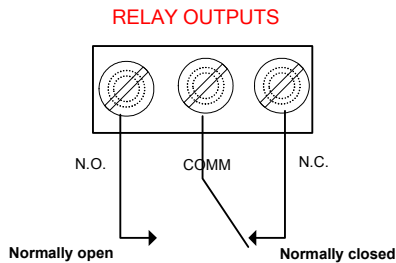

If relays are set to Normally closed, the relay is powered up with the controller and the device linked to the relay is functioning. The relay will shut down when the specified alarm condition is reached.

If the relay is set to normally open, the relay will remain off when the controller is powered up and the device connected to the relay will only be activated when the specified alarm condition is reached.

*Note: These functions are reversed if the controller Failsafe mode has been activated.*

## **Jumper Use Instructions**

The jumpers on the controller PCB allow a variety of operations to be performed manually:

- EOL 1-4:** Enables the user to add End-Of-Line jumpers that improve communication signals. Put the jumper in R position (as shown on wiring diagram) to activate the End-of-Line termination. (R provides a resistance termination and RC provides resistance and condensator termination.)
- SHDN:** Enables the microcontroller to be reset or temporarily shut down. This function is used mainly when system wiring adjustments are needed (power off for safety).
- Relays J29-J32** These jumpers allow the relay to be tested by activating it without having any effect on Events.

# Getting Started

The controller units are customized to the purchaser's specifications but they can be further programmed using the following menu options.

## Initial Startup

Make sure that all wiring has been completed according to specifications in the wiring details before powering up the unit. When all is secure, remove the SHDN jumper to power-up the unit. It should only take a few seconds until the unit is fully operative.

## Datalogger (SDcard)

The DLC (Data Logger Card) option for the controller collects data and stores it on a digital Flash memory card (SDCard). In the event that the card memory becomes full:

- Information logging is stopped
- No SDcard flag is displayed on-screen
- The SDcard LED blinks

See the Acquisition section for more details on starting and stopping the datalogging function.

---

**CAUTION**

Always deactivate datalogging function before removing the SDcard. Never remove the card when its LED is on.

---

## Programming Interface

The front panel of the 96D provides a programming keypad (buttons) and LEDs.

96D front panel Keypad

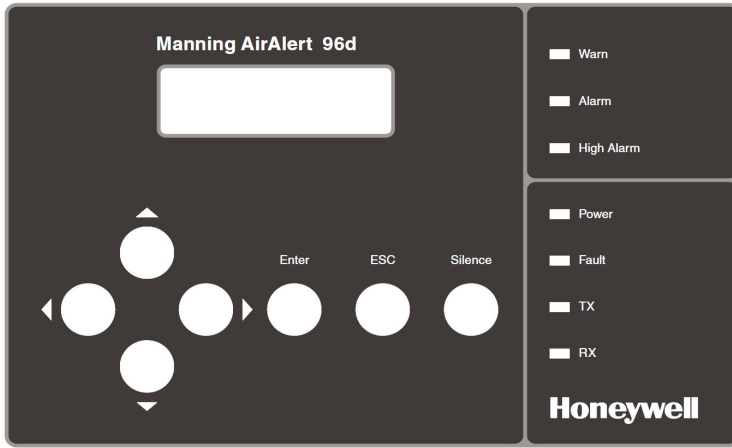

### Keypad Functions

Each unit has 7 keypad keys, or buttons:

- Arrows:** Used to move the cursor through the various programming fields (Up, Down, Left and Right), or to adjust the display contrast (press and hold the up or down arrow until desired contrast is reached and release).
- ESC:** Used to exit the programming menu or to cancel a change or input.
- Enter:** Used to access the programming menu and to modify programming fields.
- Silence:** Turns off the controller's buzzer.

## System Programming

The system's Normal programming mode offers several menu options that are accessible from the main menu screen:

- Tx Info:** Allows transmitter parameters to be programmed
- Groups:** Allows groups of transmitters to be set up
- Events:** Allows events and event behavior to be programmed
- Acqui:** Allows the datalogging feature to be activated or deactivated
- Copy:** Allows data or parameters to be copied from the (controller) configuration to parameters
- Config:** Allows system parameters and password to be set
- Network:** Allows actions on the network to be performed, communication statistics to be consulted, and remote calibrations to be performed
- Tests:** Allows each device to be tested sequentially (inputs, outputs, communications, events, etc.) and operation of various parameters to be validated
- BACNet:** Allows a device's BACNet parameters to be set
- Wireless:** Allows a network of wireless gas detection devices to be configured, monitored, and modified.









*Note: Access to the programming functions is password protected.  
The default password is 2967.*

The screen display shown below appears initially. This display can be configured to scroll among the information screens for each device connected to the controller.

AA 96d	Ver. 3.00
Ad: 1	Gr:0 Ev:0
	
2007-01-17	13:18:18

If one or more of the connected devices is in an alarm mode, the controller will only scroll between the main information screen and the screens for device(s) in alarm mode. In this case, you must scroll manually to view screens for other devices.

The information screen also displays icons representing certain system functions. Here is a list of possible icons and their meaning:

Icon	Description
	BACnet is not offered with the model 96d controller unit.
	BACnet is not offered with the model 96d controller unit.
	Debug: Indicates whether the controller is in debug mode (Single TX, Debug or Simulation modes). When in simulation mode, SIM appears next to this icon.
	Log: Indicates that either “Tx Logging” or “Event logging” is enabled.
	Log error: Indicates that an error occurred during TX or Event logging. All logging functions are stopped.
	SDC: Indicates that an SDcard is present and functioning. The icon “fills” (from white to black) progressively as memory is used. A white icon indicates empty memory and black indicates full memory.
	SDC error: If this symbol persists for more than 5 seconds, an SD card is present but not functioning properly.
	Wireless networking is not offered with the model 96d controller unit.
	Wireless networking is not offered with the model 96d controller unit.



## System Programming

### Programming Interface

---

Since the controller's programming functions are password protected, it is necessary to access the login screen:

- Press Enter to access the programming options. The password screen appears:
- Use the keypad Up or Down arrows to increase or decrease the value, one digit at a time, starting with the first digit
- When all the digits of the password are correct, press Enter to access the programming functions.

PASSWORD  - - - -
-------------------------

The first MENU options screen appears. Use the keypad arrows to navigate through multiple screens to the desired function and press Enter to access it.

MENU	
→ 1. Tx Info	3. Events
2. Groups	4. Aqvi

← MENU →	
→ 5. Copy	7. Network
6. Config	8. Tests

← MENU	
→ 9. BACNet	
10. Wireless	

## Tx Info Menu

Tx Info is the menu option that is dedicated to transmitter information and contains several sub-menu options. The exact list of screens will vary depending on the transmitter type. A summary is presented below with details on the following pages

Ident:	Allows the network component's identification information to be viewed.	◀ 1. Tx INFO 001 ▶ -Ident- E3POINT COMB
COM:	Allows the communication protocol to be viewed or changed	◀ 1. Tx INFO 001 ▶ -COM- MdbS RTU 8D 2S NP 9600 bauds
Detection	Allows the detection range and	◀ 1. Tx INFO 001 ▶ -Detection- Scale: 0 - 1.00 Units: %
Scale(1)	the unit of measurement	◀ 1. Tx INFO 001 ▶ -Scale(1)- MAX 01000 MIN 00000
Scale(2):	parameters to be viewed and changed	◀ 1. Tx INFO 001 ▶ -Scale(2)- Factor 00010 Units %
Display:	Allows the label (or name) of a specific component to be changed	◀ 1. Tx INFO 001 ▶ -Display- edit (20 chard max) E3POINT COMB Ad001
Alarms:	Allow alarm thresholds to be viewed and sometimes changed. There can be significant variations in this screen depending on transmitter type.	◀ 1. Tx INFO 001 ▶ -Alarm A- MIN MAX 20.0% 25.0%
Status	Transmitter and node status	◀ 1. Tx INFO 001 ▶ -Operating Times- Lifetime 0h Since Calib 1234h
Displays:	(in hexadecimal values)	◀ 1. Tx INFO 001 ▶ -Status Codes- Tx Status 0000h SnSr Status 0000h
Erase or Current Tx:	Erases or changes the Tx address	◀ 1. Tx INFO 001 ▶ Erase current Tx Change Tx address

## Ident Menu

The Ident, or identification menu allows a component's network ID to be consulted:

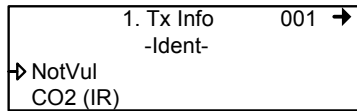

The upper right corner of the screen shows the component's address. If the address of the device whose information must be viewed is known:

- Use the arrows to move the cursor arrow to the on-screen address
- Press Enter (the value can be edited while the number is flashing)
- Use the up or down arrows to increase or decrease the value
- Press Enter again to validate the entry and display the information for the desired device.

The bottom left corner of the display shows the transmitter name (ex.: 301D2 - product name) and the sensor type (ex.: CH4 - methane sensor). These values can also be changed for Group or Vulbus product types. The procedure is identical for both fields:

Programming or changing a product or sensor type

- Use the arrows to move the cursor to the product type field.
- Press Enter to select the field (the value can be modified when flashing)
- Use the arrows to scroll through the list of product types and press Enter when the desired product or sensor appears

## Product and Sensor Types

This is a list of all the (preprogrammed) product types available from the Identification option in the Tx Info menu.

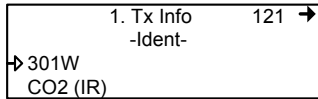

The order of the products below is not necessarily the order in which they will appear in the controller

<b>Product Types</b>		
<b>Addresses 1-96</b>		
VA301D2	VA301AP	XNX
90DM3R	VASQN8X	XCD
VA301IRF	VA301EM	VA201R
IRT100	VA301EMRP	VA201T
EC-F9	GsPnt2	90DM2
VA201T2	S301RLC	VA201D
VA301T	(Std.Device)*	VA301D
GsPnt	VA901T	NotVul
RgRt3		

\* E3Point and 420MDBS are examples of standard devices.

*Note: When Group is selected as a product type, the remaining Tx INFO screens are not accessible (because each product in the group has already been individually programmed). Only the Ident and Erase current Tx screens will be available.*

## System Programming

### Tx Info Menu

---

The sensor type list applies to address ranges 1-96 and is not dependent on the type of product selected. Devices in the address range from 97-170 will display a BACNet object identifier, rather than a sensor type.

\*An additional Product Type, simply called “Group”, represents a group created in the Groups Menu in the controller. When scrolling through the available product type list, this name will appear as many times as there are groups created in the controller (example: Group 1, Group 2, Group 3, etc.). If a group is selected as the product type, then the sensor type options are limited to MIN, MAX and MEAN.

## COM Menu

This screen displays the selected communication protocol for device addresses from 1 to 96. Each transmitter's protocol is defined by the controller (see Network Auto-configuration section)

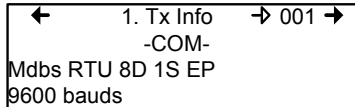

If a transmitter is compatible with several different protocols, it can be modified using to one of the following options:

- Vulbus
- MdbS ASCII 7D 2S NP 9600 bauds
- MdbS RTU 8D 2S NP 9600 bauds
- MdbS RTU 8D 1S NP 9600 bauds
- MdbS RTU 8D 1S OP 9600 bauds

When a transmitter is configured with the Modbus communication protocol, the transmitters automatically sends the programmable parameters to the controller.

*Note: Vulbus transmitter parameters must be programmed manually.*

## Scale Menus (1 and 2)

These menus appear only for certain devices. Scale(1) allows the detection range, minimum and maximum, to be defined for the selected device. Whatever value is specified is the value that will appear at the device display (if applicable). The Minimum value is generally left at 0. Parameters for the XNX and XCD gas detectors can be viewed here but can be changed only at the transmitter.

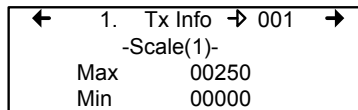

Scale(2) allows the factor by which to divide the scale (between 0 and 65535) and the unit of measurement for the selected scale to be determined.

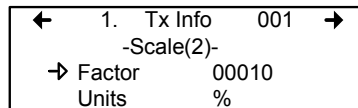

The factor allows precise scale limits for detection to be set. By dividing the maximum scale value in the first Scale screen (250 in this example) by 10, a scale value of 25.0 can then be displayed.

The “Units” allow the unit of measurement for the device to be selected:

- °F: Sets degree Farenheit as the unit of measurement
- °C Sets degree Centigrade as the unit of measurement
- %RH Sets Relative Humidity as the unit of measurement
- mV Sets millivolts as the unit of measurement
- V Sets volts as the unit of measurement
- mA Sets milliamps as the unit of measurement
- % Sets the percentage of gas as the point unit of measurement
- ppm Sets parts per million of gas as the point unit of measurement

## Detection Menu

The detection menu (available only for devices with addresses between 1 and 96) displays the detection range (scale: 0-100.0) and the unit of measurement (unit: %) for the selected component. If a transmitter uses the Modbus protocol, the detection parameters are automatically defined during network configuration and are not editable. Vulbus protocols must be manually defined by the programmer.

The detection scale is between 0 and the maximum value (0.00) and the unit of measurement is either ppm or percent (% for oxygen and % LEL for combustibles).

The detection menu is not available for the VA301R or VA301AP.

←	1. Tx Info	001 →
	-Detection-	
→	scale: 0-0.00	
	unit: %	

Programming or modifying the scale range or unit:

- Use the arrows to move the cursor to the scale or unit option
- Press Enter and use the arrow to increase or decrease the value
- Press Enter when the desired value is obtained



## System Programming

### Tx Info Menu

---

## Display Menu

This option allows a specific label or name to be assigned to the selected component (transmitters, relay modules, annunciators). Up to 20 characters, including spaces, can be used in the label (example: BOILER ROOM). The default Modbus transmitter labels are composed of the component (or transmitter) name, sensor type and address.

Vulbus transmitter labels contain 20 blank characters (spaces).

←	1. Tx Info	→ 001 →
	-Display-	
edit	(20 char.max)	
301D2	CH4	Ad001

## Alarm A, B and C Menus

The screens for viewing alarm thresholds are combined in this manual. There will be either two or three levels, depending on transmitter type.

If present, separate “MIN” and “MAX” levels permit manual control of the hysteresis of each alarm. Normally, the “MAX” level is set greater than “MIN.” However, alarms can be made to trigger on falling concentration (as with oxygen) by setting the “MAX” threshold smaller than the “MIN” threshold.

With certain transmitters, only one threshold will be displayed.

Additionally, with certain transmitters, the alarm thresholds are read-only at the controller. These thresholds can be set only at the transmitter.

These are typical screens:

```
◀ 1. Tx INFO 001 ▶  
-Alarm B-  
Level  
20.0 ppm
```

Typical screen for viewing alarms A or B on XCD and XNX transmitters

```
◀ 1. Tx INFO 001 ▶  
-Alarm C-  
MIN MAX  
60.0% 65.0%
```

Typical screen for viewing or changing alarm A, B, or C thresholds on other transmitters.

## Servicing and Operating Menus

These functions vary depending on the transmitter type. These displays show the total time the device has been in service and the amount of time remaining until the next required calibration or replacement.

```
◀ 1. Tx INFO 001 ▶  
-Operating Times-  
Lifetime 0h  
Since Calib 1234h
```

```
◀ 1. Tx INFO 001 ▶  
-Servicing-  
1234 Hours on  
15514 before cal.
```

```
◀ 1. Tx INFO 001 ▶  
-Operating Times-  
Sensor life left:  
321 days
```

## Status Code

These screens display transmission or node status and sensor status for the selected transmitter. This read-only information can assist service personnel in troubleshooting.

The XNX and XCD gas detectors will report the warning or fault number (iFaultWarnNumber) in hexadecimal on the third line. These transmitters will also report the monitoring state (iMonitoringState) in the fourth line. See the transmitter documentation for interpretation of fault numbers and monitoring states.

```
◀ 1. Tx INFO 001 ▶  
-Status Codes-  
Tx Status      0000h  
Monitor State  0001h
```

Typical display for XNX or XCD

```
◀ 1. Tx INFO 001 ▶  
-Status Codes-  
Tx Status      0000h  
Snsr Status    0000h
```

Typical display for other transmitters

## Erase Current Tx

This function allows the configuration to be erased or the Tx address for the displayed component to be changed.

*Note: Selecting erase current Tx only erases the current device entry Tx Info configuration. No other data is erased.*

```
◀ 1. Tx Info → 001 ▶  
  
erase current Tx  
Change Tx Address
```

## Change Tx Address

Selecting Change Tx Address allows users to move a device from one TX address to another:

- Use the arrows to scroll to Change Tx Address and press Enter to select
- In the next screen, scroll to the address number and press Enter to select
- Use the up or down arrows to increase or decrease the address value and press Enter to validate the new address.

The Change Tx address option is only available (active) for device address 1 to 96 and if there is a Modbus device connected.

If the address is valid, the screen will display “Processing”.

If the address is invalid, the screen will display “Invalid Tx” and return to the Change Tx Address screen (the address for GasPoint devices cannot be changed)

A final screen will display either “Error” or “Success” (re-start procedure if Error is displayed).

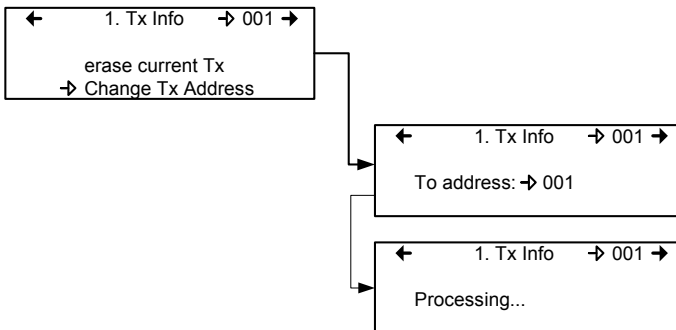

*Note: If a device address is changed to one already associated with another device, the existing data will be overwritten. Customers should know their network’s address assignments and be careful when changing a Tx address. Delete the original Tx address to avoid duplicate entries. This feature is not supported with XNX and XCD transmitters.*

## Groups Menu

Programming groups of transmitters allows several units to be combined which then enables actions (events) to be taken based on a series of units rather than each unit, individually.

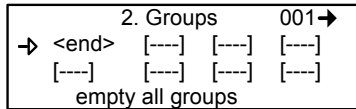
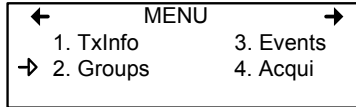

A group is a stack containing the addresses from each of the transmitters included in the group.

Groups are displayed in a single line; if a group contains more than four components, the arrows must be used to scroll left and right of the display window to view all members of a group.

The cursor in the Group screen is represented by the blinking brackets (<end>). Any information between the brackets can be edited.

## Creating Groups

- Use the arrows to move the cursor to a group line and press Enter
- The field can be edited when the brackets stop blinking and the word "end" blinks
- Use the up or down arrows to scroll through the list of all units connected to the 96D, until the desired address is displayed .
- Press Enter again to validate the address.
- The address is added to the group and the <end> bracket is shifted one position to the right.

The process can be repeated until all the desired transmitters in the group (up to 126) have been added. The address for each transmitter added in the Tx Info menu is available when creating groups.

*Note: Groups created in the Groups menu will appear in the product type list (Tx Info - Ident screen) as "Group xx" (the number assigned to the group when it was created).*

## Deleting Groups

Use the *empty all groups* command to delete all groups previously programmed in the controller.

Single groups can be deleted with a simple procedure:

- Scroll to the first transmitter in the group list,
- Select the transmitter (its address blinks) and scroll to <del> (<del> erases the entry and <end> marks the end of the stack)
- Press enter and the group is emptied.

This procedure makes it possible to delete one, several or all entries previously included in a group.

*Note: Up to 126 groups, with a maximum of 128 members each, can be created.*



## **Event Menu**

Though the controller has a default setting for Event configuration (as shown below), the Event menu is programmable. Event programming lets specific actions to be defined:

Action:	What will be done if programmed criteria are reached
Delay:	Defines the length of time to wait before taking an action on an event and time to wait after an event has returned to normal before the action output is returned to normal state.
Conditions:	AND, OR or none (---); equations that allow more detailed control of an event
Coverage period:	Determines the period during which the event is applicable
Status: disabled:	Disables or enables a programmed Event
Database:	Erases the selected event or all events

3. Events → 001→  
-Action-  
Target: Ctrl  
Relay: #01

← 3. Events 001→  
-Delays-  
Before: → 99min  
After: 01min

← 3. Events 001→  
( 1/3 Gr036 🔍 ) AND  
= 2.01%

← 3. Events → 001→  
-Coverage Period-  
All day  
All week

← 3. Events → 001  
-Status : disabled-  
→ Enable event  
.

← 3. Events 001→  
-Database-  
→ Erase current event  
Erase all events

## Action Menu

Actions are comprised of two parameters:

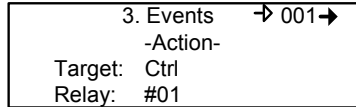

- Target**      Indicates which component is responsible for the action to be taken;  
Tx (transmitter)  
Re (Relay/Annunciator)  
Ctrl (Controller)
- Relay**      Indicates which of three possible outputs will be activated when the event is true;  
#XX (activates the component's #xx relay), Buzzer (activates the component's audible alarm)  
ALL (activates the relays and audible alarms)

Example: Tx 007 detects a concentration exceeding the set values. The target (controller) triggers relay 1 connected to that event (a fan perhaps).

## Delays Menu

This option allows Before and After settings that will delay the activation or deactivation of an action to be programmed.

**Before** Delays the action for the specified length of time. If the condition persists beyond this delay, the defined action is executed.

**After** The time to wait after an event has returned to normal before returning action output to normal state. The after delay also offers a Latch option, described below.

```
←      3. Events      001→  
-Delays-  
Before: → 99min  
After:   01min
```

Before and After delays can be configured at either 30 or 45 seconds or from 1 to 99 minutes, in one minute increments. Five dashes (-----) indicates that no delay has been programmed.

- Use the keypad arrows to scroll to the desired option
- Press Enter to select the option
- Use the keypad arrows to scroll through the second or minute settings
- Press Enter at the desired setting. The delay is set.

#### Latch Mode

- The Latch function is executed on an Event state
- It is possible to select the Latch mode by changing the after delay to *“latch”*
- The Event stays active until the Silence keypad button is pressed
- The Silence keypad button has two functions: Silence the buzzer and unlatch the event.
- When the Silence keypad button is pressed, events in Latch mode are unlatched and reevaluated. If the Event condition persists, the Event remains active and returns to Latch mode. If the condition does not persist, the event is deactivated.

*Note: If the Event has a Before delay and the Silence button is pressed while the Event conditions are still true, the buzzer will be silenced only for the length of the programmed delay.*

## Conditions

Conditions are the parameters that define what makes an Event true. Each condition is defined by four elements and can be combined with other conditions to provide greater flexibility. A condition, as in the example provided below, defines:

IF at least 1/3 of group 36 detects concentrations greater than 2.01% of specified gas AND all of group 03 detects a concentration greater than 2.99% of gas, then the specified action (Actions were set at the first Event screen) for that Event will be triggered.

Since the display screens offer limited space, scroll left and right to view and edit further information.

Condition programming screens

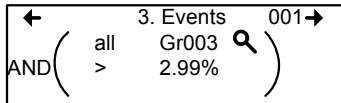
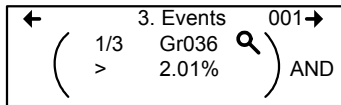

The portion of the Events condition screen that is within the brackets is divided into four editable list fields:

## System Programming

### Event Menu

---

The top left portion contains the statistic quantifier (available only for Groups) that take only the specified part of the group into the equation. Options available in this field are:

- all: includes all transmitters in the group
- mean: includes the average concentration for the group's transmitters
- max: includes the group's maximum concentration
- min: includes the group's minimum concentration
- 1/4: includes at least a quarter of the group's transmitters that meets set conditions
- 1/3: includes at least a third of the group's transmitters that meets set conditions
- 1/2: includes at least half of the group's transmitters that meets set conditions
- 2/3: includes at least two thirds of the group's transmitters that meets set conditions
- 3/4: includes at least three quarters of the group's transmitters that meets set conditions
- 1 or +: at least one or more than one of the group's transmitters that meets set conditions

The bottom left portion contains the logic, or operator, quantifier that determines how conditions are calculated. Options available in this field are:

Operator Symbol	Meaning
---	No operator
=	Equal to
<=	Equal to or smaller than
<	Smaller than
>=	Equal to or larger than
>	Larger than
!=	Not equal to
max	When the maximum value is reached, an action is triggered. It will not be deactivated until levels fall below minimum value
min	When concentrations fall below minimum value, an action is triggered. It will not be deactivated until concentrations rise above set maximum value

The top right portion contains the source, which defines what device or group of devices the Event will be based on. The list provides the following options:

- GrAll: Includes all transmitters (see note)
- Gr\_\_ \_: Includes only the devices in the specified group (see note)
- Tx000: Includes only the specified transmitter (connected to the controller)
- Clock: Includes only information gathered between the specified times. Selecting clock sets a condition that is applied only between the start and end time frame. It is possible to set one condition screen to specific parameters and the second to clock, which means that the specified condition will trigger an event only if it occurs during the set time period.

*Note: Clicking on the magnifying glass to the right of a Group number on the display opens a view of the Group for consultation or editing. Press Esc to close the group view and return to the Event condition screen.*



## System Programming

### Event Menu

---

The bottom right portion contains the operand, which defines what device or group of devices on which the Event will be based. The list provides the following options:

- OFF Used for status on binary inputs (ex.: used with 301ADI)
- ON: Used for status on binary inputs (ex.: used with 301ADI)
- Fault: Bases trigger on maintenance alarm, communication failure or device failure
- Alarm A: If the chosen device or group has an Alarm A or Alarm 1, an event will be triggered.
- Alarm B: If the chosen device or group has an Alarm B or Alarm 2, an event will be triggered.
- Alarm C: If the chosen device or group has an Alarm C, an event will be triggered.

The Coverage Period screen allows the period that will be covered by the Event to be defined. (The time frames for each of these periods can be defined in the controller Config menu.) This option provides two further selection fields:

Day definition field: allows All day, Daytime, or Nighttime to be selected

Week definition field: Weekend, Working Days, All week

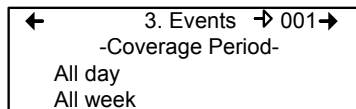

1. Use the keypad up or down arrows to scroll to either All day or All week
2. Press Enter to select. The value can now be changed
3. Use the keypad up or down arrows to scroll through options (see above)
4. Press Enter to select.

## Status

This screen displays the current event status and allows it to be either enabled or disabled, depending on the current status.

Enable event: This is a “toggle” switch; press Enter to change the value from Enable to Disable and vice versa

```
← 3. EVENT → 001
-Status : disabled-
→ Enable event
```

After going through all the steps and programming an event, this screen will display “Enable event”. Press Enter to activate all the parameters and enable the Event.

If an existing Event is being consulted, this screen would display “Disable event”. Press Enter to disable an Event (it will not be deleted but will not function). The programming of this Event is always present, which means that it easily can be reactivated by scrolling to this screen and pressing Enter.

## Database

This screens displays the options linked to the database:

Erase current event: Lets user erase the current event

Erase all events: Lets user erase all events

```
← 3. Events 001 →
-Database-
→ Erase current event
Erase all events
```

## Acquisition Menu

The Acquisition mode is only accessible when there is an SD card present (controllers with the Data Logging, or DLC function). It is used to enable or disable the logging of system Events or transmitter information. The information is logged (or recorded) on an SD card. Intervals or conditions must be defined before using this option.

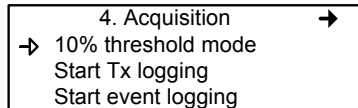

The first line of the Acquisition screen offers either :

**Delay mode:** Allows for delay intervals of 10 to 59 seconds or 1 to 60 minutes.

**Threshold mode:** Allows log values to be set according to set variation thresholds (based on last reading) of 3% or more, 5% or more or 10% or more of last detected concentration.

If a 3% threshold is selected, the system will not log a value at 3% but will log a value of 3.1%. Remember that the sampling rate (system refresh rate) may have an impact on logging.

Here is an example of threshold logging. The logs a semi-colon delineated text files.

```
2005-04-27 11:05:20;1_CO2_ppm;574;-normal-:
2005-04-27 11:06:02;1_CO2_ppm;503;-normal-:
2005-04-27 11:06:15;1_CO2_ppm;562;-normal-:
2005-04-27 11:06:28;1_CO2_ppm;645;-normal-:
2005-04-27 11:06:39;1_CO2_ppm;557;-normal-:
2005-04-27 11:30:45;1_CO2_ppm;715;-normal-:
```

## Starting and Stopping Tx Logging

In the previous step, “Acquisition”, the frequency at which Tx logs would be recorded can be configured. To start the logging function:

When “Start Tx logging” appears on the display, it indicates that the acquisition, or logging, mode is inactive. When “Stop Tx logging” appears, it indicates that Tx data is being logged. The log message is displayed on the screen according to the chosen mode and LED 1 will light up.

Press the Enter keypad button to stop or start Tx logging.

When Tx data is logged, the system creates files named **tayymmdd.log**, **tbyymmdd.log** and **tcyymmdd.log**, each representing one third of the network. The record includes the transmitter’s date, time and address, the sensor type, the concentration read, as well as the alarm status. Here is a sample of what a Tx log looks like:

```
2004-01-23 17:54:25; 001_CO_ppm;0;-normal;-002_NO2_ppm;1.5;-normal;-003_CO_ppm;0;-normal-  
2004-01-23 17:55:25; 001_CO_ppm;0;-normal;-002_NO2_ppm;0.5;-normal;-003_CO_ppm;0;-normal-  
2004-01-23 17:56:25; 001_CO_ppm;0;-normal;-002_NO2_ppm;0.5;-normal;-003_CO_ppm;0;-normal-  
2004-01-23 17:57:25; 001_CO_ppm;0;-normal;-002_NO2_ppm;1.0;-normal;-003_CO_ppm;0;-normal-  
2004-01-23 17:58:25; 001_CO_ppm;0;-normal;-002_NO2_ppm;1.5;-normal;-003_CO_ppm;0;-normal-
```

The first column of the Tx log displays the date (yyyy-mm-dd) and the time (hh:mm:ss) of the log. In this example, the “Delay mode” was set to one minute intervals.

The third column of the Tx log displays the transmitter address and the fourth displays the gas type, gas concentration and unit of measurement.

The display then lists the next transmitter address with its gas type, concentration and unit of measurement, and so on until all the transmitters have been listed.

## Starting and Stopping Event Logging

The Acquisition menu offers an event logging option. Event Logging records controller transactions, events, Tx and alarm flags and relay status.

When “Start Event logging” appears on the display, it indicates that the acquisition, or logging, mode is inactive. When “Stop Event logging” appears, it indicates that Event data is being logged.

Press the Enter keypad button to stop or start Event logging.

When Event data is logged, the system creates a file named **evyymmdd.log**. The record includes the date, time and the event. Here is a sample of what an Event log looks like:

```
2004-01-23 17:54:25: Event logging enable
2004-01-23 17:55:25: Event logging enabled
2004-01-23 19:05:47: Simulation sequence activated
2004-01-23 19:05:48: Tx 6 communication no more in fault
2004-01-23 19:05:48: Tx 8 communication no more in fault
```

The first column of the Event log displays the date (yyyy-mm-dd) and time (hh:mm:ss) of the log. Column A displays the date and time of the log. In this example, the event’s “Delay mode” was set to one minute intervals.

The system logs the following types of events:

- Event Log
- Event status changed
- Alarm A, B, C, Fault, and X status changed

*Note: New log files are created when the existing files reach 32 000 lines or at the start of a new week (0h00 Sunday)*

## Copy Menu

The Copy menu allows programmed parameters to be copied and transferred. Data from the SD card can be transferred to a controller or from a controller to the SD card or copy parameters from one device to the next. The Copy option offers three screens: Configuration, Parameters and System Log.

## Configuration

If the controller is equipped with an SD card, the configuration function allows data to be transferred either from the 96D to the SD card or the reverse. This makes it possible to transfer the controller's programming to a computer or from a computer to the controller.

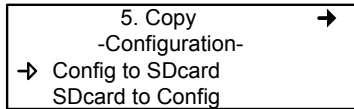

The first option in the configuration screen is 96D to SDCard. Selecting this option copies the controller's configuration and parameters into a "config.ini" file <sup>1</sup>.

The second option is SDCard to 96D allows the configuration and parameters of the "config.ini" file on an SDCard to be copied to the controller.

*Note: The "config.ini" file contents can be modified at any time and from any computer.*

1. When transferring data, the system will automatically search for an existing "config.ini" file before proceeding. If one exists, the system searches for a "config.bak" file. If found, the file is deleted. Then, the pre-existing "config.ini" file is renamed "config.bak", making it possible to save the new "config.ini" file and keep a backup copy of the previous one.

After inserting an SD card into the controller, the controller's system looks for an existing "config.ini" file that contains an "autoload" tag equal to 1 (yes). If the tag is found, the system loads the contents of the file and resets "autoload" to 0 (no). This is a useful feature for editing the file on a computer without having any impact on the controller (such as recorded Events).

## Parameters

The “parameters” function allows one transmitter’s configuration to be copied to another or one event’s parameters to be copied to another event. This allows several devices that share identical or similar parameters to be quickly configured.

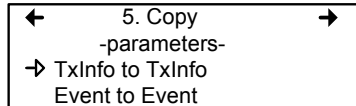

The options within this screen are:

Tx Info to Tx Info copies transmitter parameters from one device to another.

Event to Event copies parameters from Event to Event.

The process is identical for both options:

- Select source, (the data to be copied) using the up/down keypad arrows and press Enter.
- When the transmitter address is flashing, use the up/down keypad buttons to search for the desired device address.
- Press Enter to select the new address
- Select the target address (where the data is to be copied to) in exactly the same way as source
- Select COPY and press Enter. The parameters have been copied.

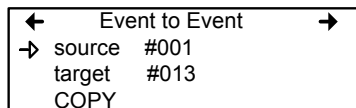
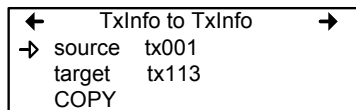

## System Log Menu

The controller will record log information to its internal memory. If the controller is equipped with an SD card, the system log function allows users to save system log information to the memory card in text format.

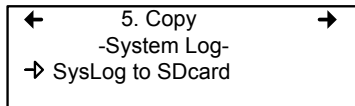

When this option is selected, a log of all the last actions performed on the controller is copied to the SDcard, with the filename **slyymmdd.log**. This file can contain up to a maximum of 64Kb of information in text format. Once the memory card is full, the oldest log entries are erased and replaced by new entries.

Here is an example of a system log:

```
--- START of system log dump : 2007-04-18 13:19:05 ---  
2007-04-04 18:42:06;Accessing menu;  
2007-04-04 18:43:47;Event 1 definition modified;  
2007-04-04 18:48:12;Exiting menu;  
2007-04-04 18:54:49;System power-down;  
2007-04-04 18:56:40;System power-up;  
2007-04-04 19:02:44;Accessing menu;  
2007-04-04 19:03:07;Event 6 definition modified;  
2007-04-04 19:03:21;Exiting menu;  
2007-04-05 10:51:28;Accessing menu;  
2007-04-05 10:54:59;Database reset;  
2007-04-05 10:55:18;Tx 25 parameters modified;  
2007-04-05 10:55:29;Group 0 definition modified;  
2007-04-05 10:55:36;Group 0 definition modified;  
2007-04-05 10:55:46;Group 0 definition modified;  
2007-04-05 10:55:55;Group 4 definition modified;  
2007-04-05 10:55:57;Exiting menu;  
2007-04-05 10:56:02;Accessing menu;  
2007-04-05 10:56:19;Tx 24 parameters modified;
```



## Config Menu

The Config menu contains several main configuration screens and is used to program the controller display mode, adjust the date and time, select the display language, change the controller access password, modify the Slave Port configuration, set the Relay Configuration, and select the AP Broadcast mode.

Each main screen offers further programming options, as shown.

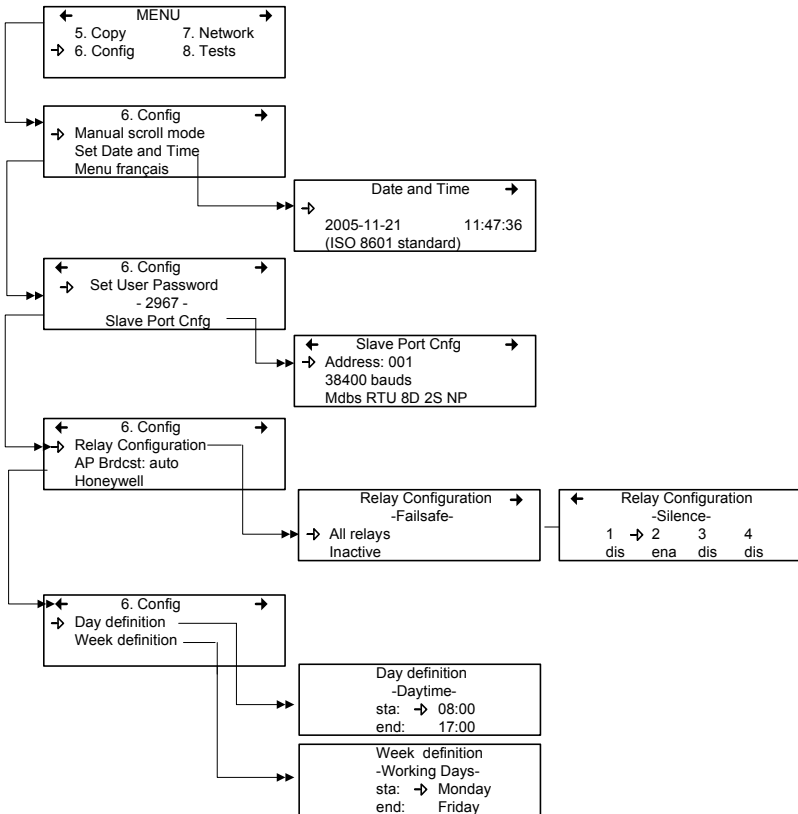

Selecting the first line of the first screen allows selection from three display modes: Manual scroll, 3-second scroll, 5-second scroll. If Manual scroll mode is chosen, the screen will only advance if you press on the arrow keypad buttons. If either 3 or 5 second scroll mode is chosen, the screens will automatically scroll display readings for all devices connected to the controller after 3 or 5 seconds.

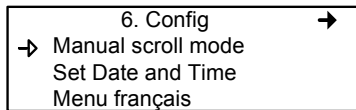

3 or 5 second scroll modes do not prevent the keypad arrows to be used to return to a previous screen or move ahead through the screens manually.

Selecting the second line allows the date and time in a new screen to be adjusted; Date and Time. When a number is flashing, the value can be changed using the up/down keypad arrows. The year, month, day and the hour, minute and second values can be changed.

The controller does not manage Daylight Savings Time, therefore, users must manually adjust any time changes.

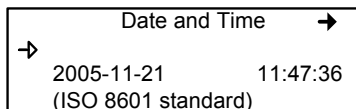

Selecting the third line allows the display language to be changed. If the display is already in English, it will then display the Menu français option (and vice-versa). Simply scroll to the line and press Enter to change the language.

## System Programming

### Config Menu

---

The second main screen in the Config menu allows a new user password to be set and the slave port configuration to be modified.

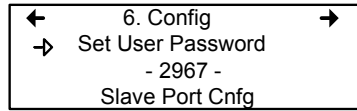

The default password is 2967. Select Set User Password to change the password:

- When the first digit blinks, change the value by using the up/down keypad arrows to increase or decrease the number
- Use the left/right keypad arrows to move from one digit to the next.
- When the desired password has been set, press Enter to validate it and exit the editing mode.

*Note: Contact Honeywell technical support for help with lost passwords at 1-800-563-2967.*

Scroll through the main Config menu screens using the left (previous) or right (next) keypad arrows.

The third main screen in the Config menu allows the relay configuration to be set, the AP broadcast mode and to select from four separate manufacturers for the given controller.

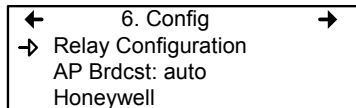

When *Relay Configuration* is selected, two further options to configure the relays are available: The first screen, *Failsafe*, appears allowing the failsafe to be activated for all relays using the Enter keypad button. This function is used in case of a power failure: if power is cut, the relay will activate the connected device (ex. a light) to signal the problem.

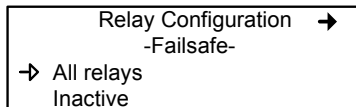

Scrolling to the right displays the "Silence" screen that enables or disables the silence option for each relay, using the Enter keypad button.

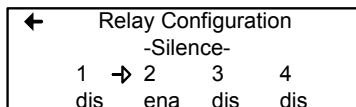

## System Programming

### Config Menu

---

The fourth screen in the Config menu allows a definition of a day and a week to be programmed.

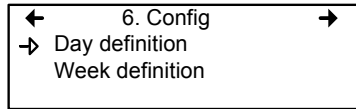

Day and Week definition allows hours (time frames) to be defined for either Daytime and Working Days respectively.

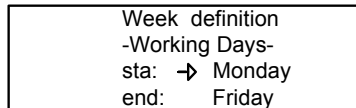
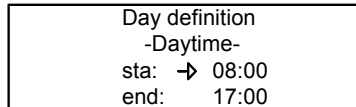

*Note: Remember, the controller uses a 24 hour clock (0:00 to 23:59). Any time changes (DST) must be made manually or through BACNet time synchronisation (BACNet module required).*

## Network Menu

The Network menu allows network device information to be either scanned or reset.

This menu offers four options, divided into two screens; the first screen contains three options:

- Reset Database:            Resets all network device Tx information in the database. This only resets the Tx information for the network device. It does not affect programmed Groups or Events.
- Network Scan:            Begins an auto-detect of all network devices that allows the system to configure the Tx database for network devices (i.e. it will scan and add new devices but will not overwrite or erase the old database)
- Reset and Scan:           Performs both previous functions simultaneously.

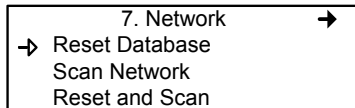

*Note: Once one of these options has been set, wait until the controller completes the process. Do not interrupt or stop the process once it has begun.*

## System Programming

### Network Menu

---

The second Network screen offers the Statistics and Calibration options.

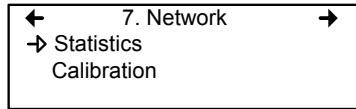

Selecting Statistics from the Network menu displays a screen containing the statistics for the selected device address.

Statistics		001
Valid	16	100%
Errors	0	0%
Timeouts	0	0%

**Valid:** Indicates the number of valid responses for the last 16 requests

**Errors:** Indicates the number of errors in the response for the last 16 requests

**Timeouts:** Indicates the number of timeouts (no response) for the last 16 requests

## Remote Calibration

The network menu also offers a Calibration option for use with devices that support network calibration.

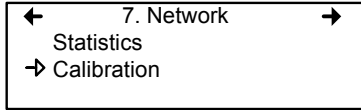

The Calibration screen contains four (4) lines of information:

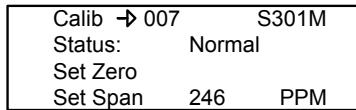

- Line 1: Indicates the mode (Calib, meaning calibration), the (Modbus) address of the device to calibrate (001) and the type of device to calibrate (301D2)
- Line 2: Indicates the status (Normal or In calib...) of the specified device
- Line 3: Displays the function to perform (Set Zero)
- Line 4: Displays the function to perform (Set Span) and the span gas concentration value (246 ppm)

5. On the first line, scroll to the device address and press Enter
6. Scroll through the devices to display the desired device\* and press Enter to select.
7. The second line displays the device's status
8. Scroll to select the desired function, Set Zero to set the device's zero, and press Enter to select.
9. Upon pressing Set Zero, the controller requests confirmation.

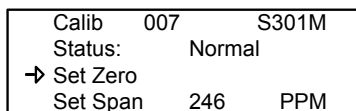

*\*The device must be configured in the 96D's database in order to be included in the device addresses displayed on screen.*



## System Programming

### Network Menu

---

10. Press Enter to confirm or Esc to cancel. If confirmed, the controller calibrates the sensor's Zero. This takes only a few moments and the display returns to the default calibration screen.

*Note: Never calibrate any unit's Zero with ambient air. Always use Nitrogen (N<sub>2</sub>) at the calibration port to calibrate the Zero.*

11. To calibrate the device, scroll to Set Span\*\* and change the span gas calibration value using this procedure;

```
Calib 001 : 301D2
Status : Normal
Set Zero
Set Span → 2.60 ppm
```

- Using the right arrow, move the cursor to xxx PPM (span value field). Press Enter to select the field (it is editable when flashing).
- Use the up or down arrows to increase or decrease the value, press Enter to validate the new value.
- Move the cursor back to Set Span and press Enter to start the calibration.

```
Calib 001 : 301D2
Status : In calib...
Set Zero
→ Set Span 2.60 ppm
```

The device Span is being calibrated. The screen will display the device's status as "In calib..." until the calibration is complete.

*\*\*When selecting Set Span, make sure that the device has been supplied with the appropriate calibration gas before and during the calibration process.*

## Tests Menu

The Tests menu allows a variety of tests to be performed on components and on the network communications. It also allows the system to be operated in four different modes which, in turn, provide different functionalities.

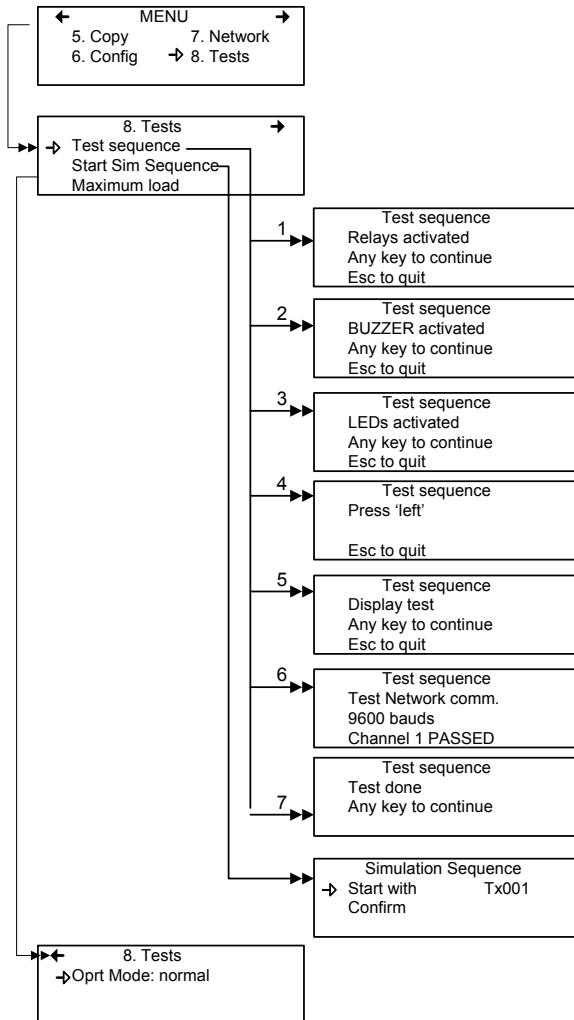

## System Programming

### Tests Menu

---

The Tests menu provides four main options, divided between two screens. Each of these options offers different capabilities.

The first screen presents three options:

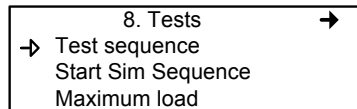

**Test sequence:** Enables each output to be activated and validates operation of each controller keypad buttons, display pixels, and various communication protocols.

**Start Sim Sequence:** This options starts or stops the Simulation mode, which allows a simulation of a gas concentration over an associated scale range on all transmitters. The simulated gas concentration values are local (on the controller) and do not affect logging functions. (Events will be activated for the simulation but detection devices are not affected.)

**Maximum load:** Activates all controller components

The second screen option is “Oprt Mode”, which offers three separate operation settings: Normal, Single Tx or Debug.

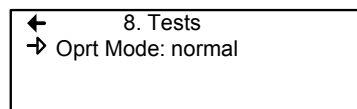

**Normal:** Normal controller operation mode

**Single Tx:** Activates the polling mode on a single transmitter.

**Debug:** Activates the service mode to perform a calibration and to test Events without triggering actions.

## Test Sequence

When test sequence is selected from the main Tests menu, the controller will display the Test sequence screen.

Test sequence Relays activated Any key to continue Esc to quit
---

If Esc is pressed on the keypad, the main Tests menu screen will be displayed. However, to perform system tests, press any key to proceed to the first test screen.

Test sequence BUZZER activated Any key to continue Esc to quit
---

This screen tests each component individually and will advance only to the next component when a key is pressed. This option will display 13 screens. Screens 1, 2 and 3 test Relays, BUZZER and LEDs.

The following six screens prompt the user to press the keypad buttons, in turn: left, right, up, down, Silence, Enter and Esc. The system will not advance until a key is pressed.

Test sequence Press 'left'  Esc to quit
--

## System Programming

### Tests Menu

---

The system then moves to the Display test. When the blank screen is displayed, it is testing for display pixels. Press any key to proceed to the next step.

```
Test sequence
Display test
Any key to continue
Esc to quit
```

The final test that the system performs is a network communication test:

```
Test sequence
Test Network comm.
9600 bauds
Channel 1 PASSED
```

Once these tests have begun, do not interrupt or stop them. The system tests all five bauds (communication speed: 9600, 19200, 38400, 57600, 115200) and each of the 4 channels per baud.

When the system has completed the test, it displays the final Tests screen. Press any key to return to the main Tests menu.

```
Test sequence
Test done
Any key to continue
```

## Normal Mode

This is the system's normal (default) operation mode. When the system is in normal mode, some values can be changed without interrupting services. When a value has been changed in any of the menu fields, the change will take effect upon returning to the main menu screen.

## Single Tx Mode

This mode allows transmitters to be analyzed one at a time. The controller polls only the selected device, which subsequently has its information updated. This mode does not interfere with Event Evaluation functions.

## Debug Mode

This mode allows complete system operation to be evaluated and tested without affecting operations (outside of debug mode). **Events are evaluated and displayed as necessary but no action is triggered.**

## Simulation Mode

This mode deactivates network communication Information Updates. It can be combined with any of the three previous modes (example: using the Simulation mode when in Debug mode allows the user to test the entire system [groups, events, etc] without triggering any actions or using any additional material such as gases). It allows gas concentrations to be simulated over an associated scale for each transmitter, sequentially:

Alarm levels A, B and C are evaluated according to the simulated gas concentration and events are evaluated and actions are taken.

This type of alarm simulation at the controller does not work with certain transmitters with falling alarms. In these cases, an alarm can be simulated at the transmitter.

While in simulation mode, the controller is unaware of the device's actual network status. This mode can be stopped at any time in the Test menu (see Normal System Operation).

If one of these modes has been activated, the system will automatically return to Normal Mode after 12 hours of inactivity. (No changes will be lost.)

## **BACnet Menu**

BACnet is not offered with the model 96d controller unit.



## **Wireless Network Menu**

Wireless networking is not offered with the model 96d controller unit.

## Specifications

---

Power requirements 96D	17-27 Vac, 50/60 Hz, 8.64 VA 18-36 Vdc, 350mA @ 24 Vdc (8.4 VA)
Operating temperature range	-20°C to 50°C (-4°F to 122°F)
Operating humidity range	0 to 95% RH (non-condensing)
Operating altitude	Up to 3000 m (9843 ft)
Network capacity	Up to 96 transmitters, 32 per channel Channels 1, 2 = Modbus Channel 3 = Modbus only
Communication (length of lines)	Up to 609m (2,000 ft) per channel T-tap maximum = 20m (65 ft) per t-tap, overall total of 40m (130 feet)
User interface	Graphic 122 x 32 dot matrix backlit display User friendly keypad
Visual indicators	Power     Green LED Warn, Alarm, High Alarm   Red LED Fault     Amber LED Tx         Amber LED Rx         Green LED
Outputs	4 DPDT relays
Output rating	5A, 30Vdc or 250 Vac (resistive load)
Audible alarm	65dBA at 1 m (3 ft)
Time delays	Programmable Before and After delays
Battery	3 volt lithium battery
Enclosure	Painted aluminum
Dimensions (HxWxD)	9.5" x 14" x 3.5" (24.1 x 35.6 x 8.9 cm)
Certifications	ANSI/UL 61010-1 CAN/CSA C22.2 No. 61010-1 ETL 116662

---



# Warranty

## Warranty Statement

All products are designed and manufactured to the latest internationally recognized standards by Honeywell Analytics under a Quality Management System that is certified to ISO 9001.

Service in the field or at the customer's premises is not covered under these warranty terms. Time and travel expenses for on-site warranty services will be charged at Honeywell Analytics' normal billing rates. Contact your Honeywell Analytics Service Representative for information on Service Contracts.

## Warranty Conditions

The Honeywell Analytics (HA) Limited Product Warranty only extends to the sale of new and unused products to the original buyer where purchased from HA or from a HA authorized distributor, dealer or representative. Not covered are: consumable items such as dry-cell batteries, filters and fuses or routine replacement parts due to the normal wear and tear of the product; any product which in HA's opinion has been altered, neglected, misused or damaged by accident or abnormal conditions of operation, handling, use or severe sensor poisoning; defects attributable to improper installation, repair by an unauthorized person or the use of unauthorized accessories/parts on the product

Any claim under the HA Product Warranty must be made within the warranty period and as soon as reasonably possible after a defect is discovered. If a Warranty claim is being sought it is the responsibility of the buyer to obtain a Service Event number (SE#) from HA and if practical return the product clearly marked with the SE# and a full description of the fault.

HA, at its sole discretion, may elect to send replacement goods to buyer prior to receipt of the defective goods. Buyer agrees to return defective goods within 30 days or to pay for the replacement goods.

## Warranty

---

Buyer is responsible for transportation costs from the buyer's location to HA. HA is responsible for transportation costs from HA's location to the buyer.

If in the case of a fixed installation or when it is not practical to return the product, the buyer should submit a claim to HA Service Department. A service engineer will attend on site on a day rate basis. Where a valid warranty claim is identified, the faulty product will be repaired or replaced free of charge. A warranty claim will be accepted if all conditions contained within this Warranty are met.

When, in the opinion of HA, a warranty claim is valid, HA will repair or replace the defective product free of charge and send it or any replacement back to the buyer. If, in the opinion of HA the warranty claim is not valid, HA will, at the option of the buyer, return the unit unaltered at the buyer's expense, repair the unit at the then prevailing rates, replace the unit with an appropriate replacement item at the then prevailing price, or discard the unit. HA reserves the right to charge for any attendance by its service engineer at the usual rates in force at the time the claim was received.

In no event shall HA's liability exceed the original purchase price paid by the buyer for the product.

## Consumer Claims

If you purchased your HA product as a consumer, the above warranty conditions do not affect your rights under any applicable consumer protection legislation.

Honeywell Analytics reserves the right to change this policy at any time. Contact Honeywell Analytics for the most current warranty information.





## Find out more

[www.honeywellanalytics.com](http://www.honeywellanalytics.com)

## Contact Honeywell Analytics:

### Americas

Honeywell Analytics Inc.  
23500 W. 105th Street, MD 400  
Olathe, KS 66061  
Tel: +1 913 712 5576  
Toll free: +1 800 444 9935  
Toll free fax: +1 888 328 2417  
[detectgas@honeywell.com](mailto:detectgas@honeywell.com)

### Europe, Middle East, Africa

Life Safety Distribution AG  
Wilstrasse 11-U11  
CH-8610 Uster  
Switzerland  
Tel: +41 (0)44 943 4300  
Fax: +41 (0)44 943 4398  
[gasdetection@honeywell.com](mailto:gasdetection@honeywell.com)

### Technical Services

[ha.global.service@honeywell.com](mailto:ha.global.service@honeywell.com)

[www.honeywell.com](http://www.honeywell.com)

### Asia Pacific

Honeywell Analytics Asia Pacific  
#508, Kolon Science Valley (1)  
187-10 Guro-Dong, Guro-Gu  
Seoul, 152-050,  
Korea  
Tel: +82 (0)2 2025 0307  
Fax: +82 (0)2 2025 0329  
[analytics.ap@honeywell.com](mailto:analytics.ap@honeywell.com)

### Please Note:

While every effort has been made to ensure accuracy in this publication, no responsibility can be accepted for errors or omissions.

Data may change, as well as legislation, and you are strongly advised to obtain copies of the most recently issued regulations, standards and guidelines.

This publication is not intended to form the basis of a contract.

# Honeywell

M-511401, 08/10

© 2010 Honeywell Analytics



## Free Manuals Download Website

<http://myh66.com>

<http://usermanuals.us>

<http://www.somanuals.com>

<http://www.4manuals.cc>

<http://www.manual-lib.com>

<http://www.404manual.com>

<http://www.luxmanual.com>

<http://aubethermostatmanual.com>

Golf course search by state

<http://golfingnear.com>

Email search by domain

<http://emailbydomain.com>

Auto manuals search

<http://auto.somanuals.com>

TV manuals search

<http://tv.somanuals.com>