

iPGSM-COM **Commercial Fire Communicator** **Installation and Setup Guide**

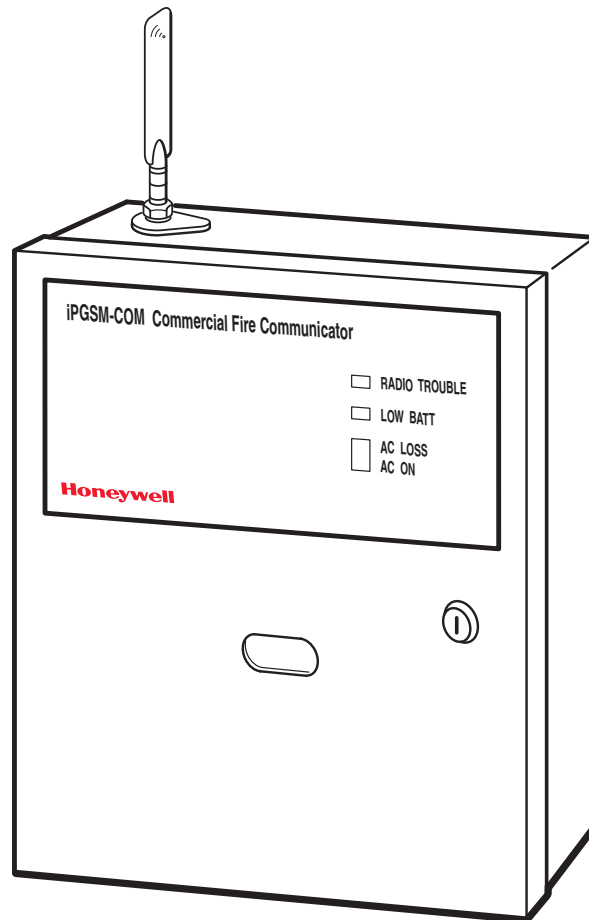

Contents

General Information	1
Package Contents	1
Compatible Fire Panels	1
Operation	1
Installation	1
UL Compliance.....	1
STEP 1 – Activate the SIM and Setup the Customer Account.....	2
STEP 2 – Register the Communications Module with AlarmNet	2
STEP 3 – Determine the Signal Strength and Select a Location	3
STEP 4 – Mount and Wire	3
STEP 5 – Program the Communications Module	6
STEP 6 – Configure the Fire Panel	7
STEP 7 – Test the System.....	7
iPGSM-COM Trouble Detection Information.....	7
Dialer Capture Module Information	8
LED Board Information.....	8
PowerBoost1 Module Information.....	9
iGSM Communications Module Information	10
iPGSM-COM Specifications.....	11
Wiring Diagram.....	Inside of Back Cover

General Information

The iPGSM-COM Commercial Fire Communicator includes everything you need to upgrade a commercial fire system that previously reported by POTS to a system that uses the Internet as its primary reporting path, and uses a GSM cellular reporting path as a backup. In addition, this communicator utilizes a sophisticated power module (PowerBoost1) that monitors and reports AC power loss, low battery, and missing battery conditions.

Package Contents

- Red Fire Cabinet and Back Plate
- Cam Lock with Key
- Dialer Capture Module
- LED Display board
- iGSM Communications Module
- 50 ohm cable assembly
- Antenna and Mounting Adapter
- PowerBoost1
- Battery harness
- Wall Outlet Box (P/N K14358)
- Transformer, 18VAC (N8167)
- Ferrite Filter
- Hardware Bag

Compatible Fire Panels

The iPGSM-COM works with Fire Panels that use the Contact ID communication format as described in the SIA DC-05 Standard. After completing the field installation, verify communications with the central station is successful by sending several events. Also, get confirmation that these events were received.

Note: For a fire panel that has more than 9 active partitions, the first 9 partitions are reported to the central station uniquely. Beyond 9 partitions, only the 2nd digit of the partition is reported along with a leading zero (example partition 14 is reported as 04). **The installer must inform the central station of this condition.**

Operation

The iPGSM-COM replaces the fire panel's POTS communications path. When an event occurs, the fire panel goes off-hook to dial the central station. The iPGSM-COM detects the off-hook condition and provides the fire panel with a dial tone. When the fire panel detects the dial tone, it begins dialing the central station. The iPGSM-COM considers the three second period after dialing as the number dialing has been completed. After the dialing is completed, the Dialer Capture Module returns a handshake to the fire panel.

The fire panel then sends the contact ID reports to the iPGSM-COM, which in turn sends a kiss-off after the report is successfully received from the fire panel. Within the iPGSM-COM, the Dialer Capture Module sends the contact ID reports over the ECP bus to the iGSM Communications Module. When all the reports are sent, the fire panel goes on-hook. The iPGSM-COM then transmits the messages to the central station (either over the internet or the GSM network).

Installation

UL Compliance

To meet UL864/NFPA, ensure the following:

- Equipment should be installed in accordance with NFPA (National Fire Protection Association) standards 70 and 72.
- iPGSM-COM must be mounted in the same room and within 20 feet of the fire panel.
- iPGSM-COM, and all equipment used for the IP connection (such as the router, hub, modem, etc.) must be powered from the same un-switched facility power source branch as the fire panel.
- iPGSM-COM must use a 7AH battery (not supplied) to provide 24-hour backup capability.

STEP 1 – Activate the SIM and Setup the Customer Account

The communicator requires a subscriber account (customer account) to be setup with AlarmNet Direct. This is accomplished by registering the communicator's iGSM communications module with AlarmNet. Registering, enables the fire panel to send reports.

To setup the customer account you will need to contact the central monitoring station to get account information, and have access to the AlarmNet Direct website. To access the AlarmNet Direct website visit – **<https://services.alarmnet.com/AlarmNetDirect>**

If you do not wish to use the AlarmNet Direct website, you may call AlarmNet to setup the account, just phone 800-222-6525, then select option 1.
(Monday–Friday 8:00 am to 9:00 pm, Saturday 9:00 am to 5:30 pm EST)

Have the following information ready:

- Primary City ID (two digits), obtained from your monitoring station.
- Primary Central Station ID (two digits), obtained from your monitoring station.
- Primary Subscriber ID (four digits), obtained from your monitoring station.
- Communication Module's MAC ID, and MAC CRC number located on outside of box, and inside of the module.

Note: The iPGSM-COM comes with a SIM (Subscriber Identity Module) that needs to be activated.

1. To activate the SIM, log into the AlarmNet Direct website and choose “SIM Activation/Status”, then enter the required information. Click **Activate SIM**.
2. Setup the customer account by choosing "Program New Device GSM/I", enter the required information. When complete, click **DONE**.

STEP 2 – Register the Communications Module with AlarmNet

Registering the module activates the account with AlarmNet and enables the fire system's control panel to send reports. There are three methods that can be used to register the communications module.

- Register the module by logging into AlarmNet Direct and choosing “Show Programmed Devices GSM/I”. Search for the account using the Account Information or MAC ID. Under the “Actions” column, use the pulldown menu and choose Register. OR
- After the iPGSM-COM is installed and programmed, you can register the module by clicking the Tamper Switch 3 times. OR
- After the iPGSM-COM is installed and programmed, you can register the module using the 7720P Programming tool. Simply: Press [Shift] then press [↑]. Please wait for "Registration SUCCESS" message.

STEP 3 – Determine the Signal Strength and Select a Location

IMPORTANT - Do Not mount this device outdoors.

When choosing a suitable mounting location, understand that signal strength is very important for proper operation. For most installations using the supplied antenna, mounting the unit as high as practical, and avoiding large metal components provides adequate signal strength for proper operation.

You will use the iGSM Communications Module to determine signal strength in order to find a suitable mounting location.

Note: If the SIM is already activated, the RSSI signal strength indicators will indicate signal strength.

If the SIM has not been activated, the firmware in the communications module enables it to communicate with the cellular network towers (without the SIM being activated) so that signal strength measurements can be determined. In this case, you can display the signal strength by simultaneously pressing the MODE and TAMPER switches.

1. For this procedure you will need a fully charged 12V battery.
2. Attach the Antenna (see illustration on page 5).
3. Temporarily wire the battery's negative [-] terminal to TB1-4 on the iGSM communications module, then wire the battery's plus [+] terminal to TB1-2 on the communications module. Wait about one minute for the module to initialize.
4. Position the assembly near a suitable mounting position and observe the RSSI display.
5. Look for a mounting position that yields at least 3 bars lit solid. Four or five bars are better.
6. Verify the signal strength remains steady for a few minutes, then mark that mounting position. Disconnect the battery.

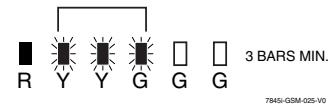

STEP 4 – Mount and Wire

- For UL compliant installations, refer to the topic on *UL Compliance* in this manual.
- For Dry/Indoor use only.
- Unless otherwise specified, use 18AWG or larger wire.
- External cabinet wiring may be routed in conduit if desired.

This communicator comes partially assembled with all the components mounted except the PowerBoost1 and the Antenna. To protect certain components on the PowerBoost1, it is shipped un-mounted but fully wired.

1. Remove knockouts from cabinet to accommodate the power input wires, and wiring to the control panel. Then mount the cabinet securely to the wall using 4 screws or bolts. Use mounting screws or bolts that are suitable for the material being anchored to.
2. Ensure the cabinet door lock is installed.
3. Carefully remove the packaging material that surrounds the PowerBoost1.
4. Mount the PowerBoost1 on the three unused standoffs. Use the **plastic screw** (prevents shorting) to secure the upper right corner of the PowerBoost1 and the two metal screws and lock washers to fasten the left side of the circuit board. Ensure the two lock washers are between the circuit board and the head of the two metal screws.

Note: Refer to the diagram on page 5, and to the Wiring Diagram on the inside of the back cover of this manual for all wiring information.

5. Mount the Wall Outlet Box to an un-switched facility power outlet and run a conduit to the cabinet.
6. Route 16AWG (minimum) wire from the transformer, through the conduit. Pass the wires through the Ferrite Filter, then loop the wires back through again making a loop. Connect the wires to the PowerBoost1 AC terminals. **DO NOT plug the transformer in.**

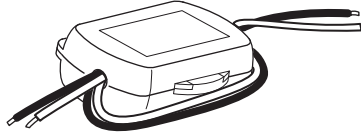

7. Connect and route 16AWG (minimum) insulated wire from facility power ground (typically a cold water pipe) to the cabinet's ground post. Ensure all ground connections are tight.
8. Connect the Ethernet cable and the Telco 1 and Telco 2 lines. If you choose to use an optional Cabinet Tamper Switch (if the control panel supports it) mount and wire it.

Note: The Ethernet cable, Telco 1, Telco 2 lines, and the optional cabinet Tamper Switch (if used) must be run through conduit.

9. Verify the PowerBoost1 module DIP switches are configured as shown below.

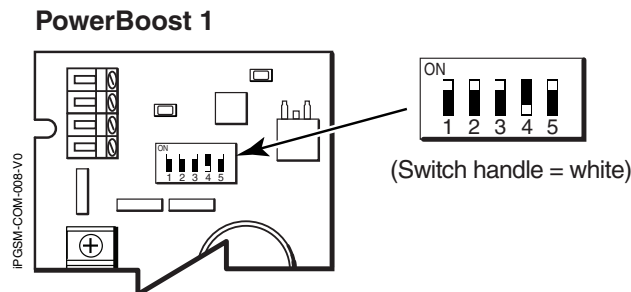

10. Ensure the following:
 - LED Display board is fully seated.
 - All wiring terminals and connectors are tight.
 - All wiring has been completed and secured with cable ties.
11. Install the battery (not supplied). Plug the power transformer in, and attach the battery cable.

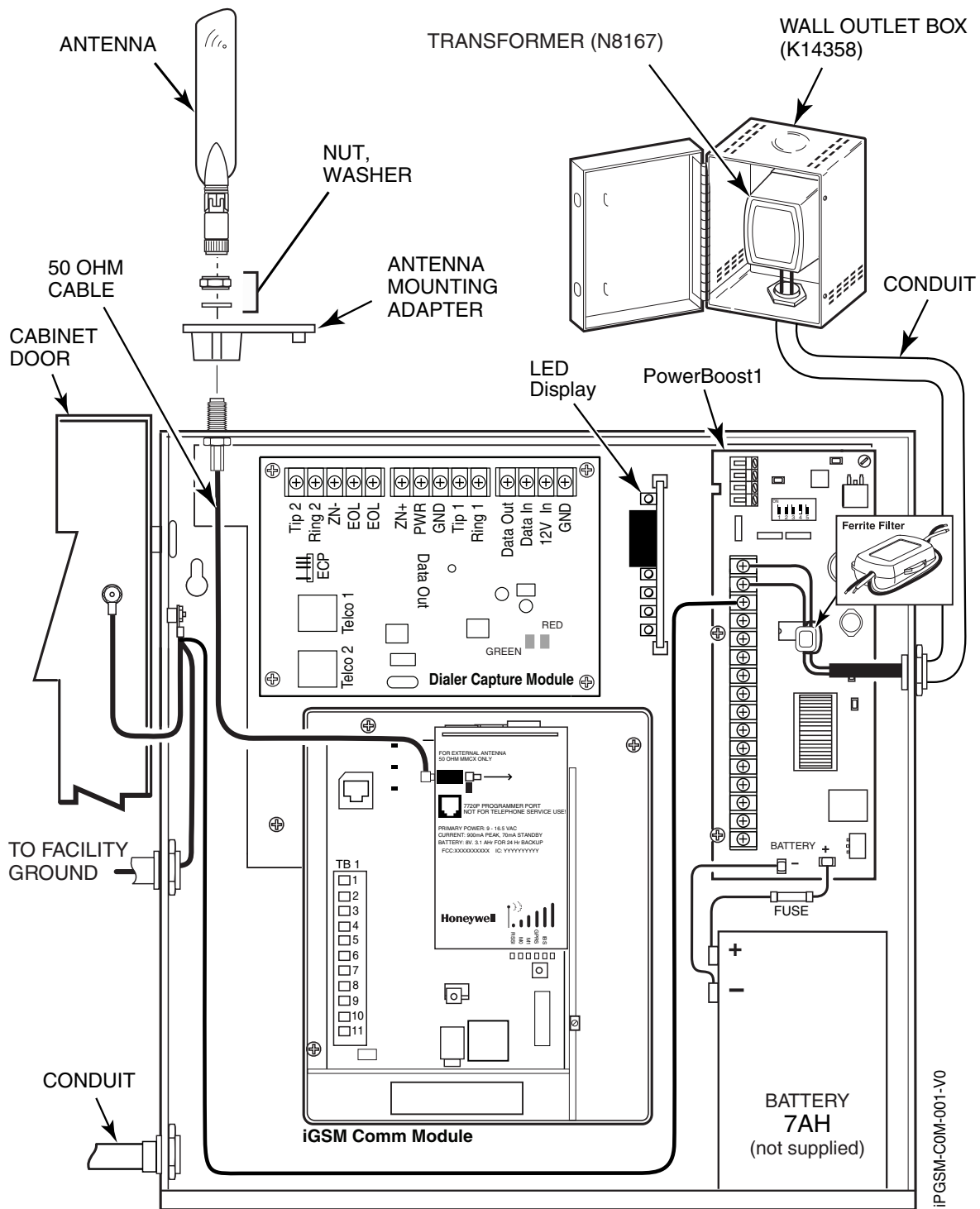

Wiring for Grounds, Power, and RF

STEP 5 – Program the Communications Module

You must use the 7720P Programming tool to program the iPGSM-COM.

When using the 7720P Programming tool, the values given below are for most installations. Press the [#] key to accept the displayed default value (xxx) or enter the new value and press the [#] key for the next prompt. Use the [*] key to scroll through a list of options.

1.	(no display)	Connect the 7720P.
2.	7720P PROGRAMMER	Press [#].
3.	Strt Prog Mode? Y/N	Press [Shift] then [Y], then [#].
4.	Program Device? Y/N	Press [Shift] then [Y], then [#].
5.	Primary City ID (??)	Enter number 01-99, then press [#].
6.	Primary CS ID (??)	Enter number 01-FE, then press [#].
7.	Primary Sub ID (????)	Enter number 0001-9999, then press [#].
8.	Review? Y/N	Enter choice, then press [#]. Follow the prompts.
9.	Create Password? Y/N	Enter choice, then press [#]. Follow the prompts.
10.	Exit Prog Mode? Y/N	Press [Shift] then [Y], then press [#].
11.	DONE	

Note: If an error in programming occurs, set the factory defaults (see next topic) and reprogram the iPGSM-COM.

To exit the programming mode, press [N] in response to the "Review?" prompt. Then press [Y] to the "Exit Prog Mode?" prompt. Upon exiting, the root file is updated to log the changes made. A message is displayed telling the user that this step is being executed. When complete, the message "DONE" is displayed to indicate the file was successfully uploaded.

Note: If critical configuration changes were made, such as the mode of operation, the communications module will reset to ensure that the programming features are enabled.

If the file is not successfully uploaded, one of the following prompts will be displayed. Follow the steps shown below until the upload is successful.

Display	Description	What to do
Cannot Upload Try Again? Y/N_	Module is not yet initialized.	Wait for RSSI indicator LEDs to be lit. Press [Y].
Failed to Update Root File!	Network problem, or you answered "N" to "Cannot Upload Try Again?" prompt.	Initiate the Force Server Update Command by pressing the [0] key.

Setting Factory Defaults

To reset the programming options to factory-default values, at the "Exit Prog Mode?" prompt press [Shift] plus [ESC]. Note, setting the factory defaults will also erase any password that may have been entered.

Set Default?	Press [Y] to reset factory default values.
Y/N_	Press [N] to cancel this function.

Press [Shift] then [Y], then [#]. The Create Password prompt appears, follow the prompts then exit.

STEP 6 – Configure the Fire Panel

1. Ensure the Telco Fault on the panel is enabled. Then choose a setting that is no higher than 90 seconds (or as close to that) as the panel allows.
2. Ensure no more than 1 pause character (usually a comma) is programmed into the dialing string (usually 2 seconds). Note, this is necessary since the Dialer Capture Module waits only 3 seconds after the phone number is dialed. Having more than 3 seconds of pause time will cause it to think the phone number is complete and cause it to generate the high-low tones at an incorrect moment.

STEP 7 – Test the System

1. Close the Wall Outlet Box, then close and lock the cabinet cover.
2. Refer to the fire panel's installation/operation guide the testing procedure.
3. (Notify the monitoring station that a test will be conducted.) Test the system to ensure it is operating.

iPGSM-COM Trouble Detection Information

Telco 1 is used for the Fire Panel to output contact ID messages to the iPGSM-COM, and Telco 2 is used by the iPGSM-COM to report faults to the Fire Panel. If Telco 1 is not operational, the Fire Panel will use Telco 2 to report events if there are no faults in the iGSM Communications module.

Fault Condition	Indication to Fire Panel
PowerBoost1 fault	Telco 2 is cut.
iGSM Communications Module fault <ul style="list-style-type: none">• Failure of one of the two communications paths.• Failure of both communications paths.	Telco 2 is cut. Telco 1 and 2 are cut.
Dialer Capture Module buffer is full.	Hang up. (Panel will retry, giving the buffer a chance to empty.)

Dialer Capture Module Information

LED Indicator	STATUS
RED – Steady ON	Messages exist in buffer.
RED – Flashing	No messages to be sent. Waiting for messages.
GREEN – Steady ON	Normal Indication.
GREEN – Blinks every 2 sec.	PowerBoost1 communication problem.
GREEN – Blinks twice every sec.	Communication Module connection is lost.
GREEN – Blinks 10 times every sec.	PowerBoost1 and Communications Module connection is lost.

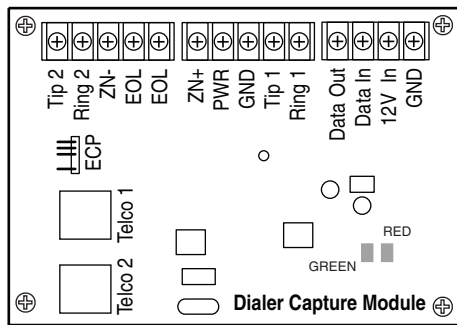

Note: Telco ports 1 (primary dialer) and 2 (secondary dialer) may be used instead of the terminal board.

Whichever connection method is used, both Telco paths must be connected to the Fire Panel.

LED Board Information

Panel Status	LED Indicator
RADIO TROUBLE	Yellow – ON when radio trouble is present.
	Buzzer – Upon loss of AC power, this will beep once every 10 seconds.
LOW BATTERY	Yellow – ON when battery is low.
	Yellow – (not used)
AC LOSS	Yellow – ON when no AC is present.
AC ON	Green – ON when AC is present.

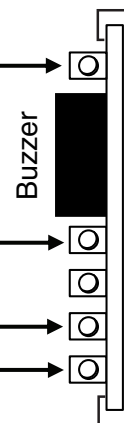

PowerBoost1 Module Information

LED Indicator	STATUS
AC (green)	AC power available.
ACTIVE (green)	Cyclical flashing – normal communications. Repetition of 3 flashes – loss of communications.
LOW BATT (yellow)	Missing or low battery.
TROUBLE (yellow)	One or more trouble conditions exist, such as; overload, output supervision, ground fault, or charger failure.

Notes:

- If AC power is lost and the battery voltage falls below 10v, the module's output voltage will be turned off. The output power is turned back on when AC power is restored.
- You must use the DIP switch settings shown below.

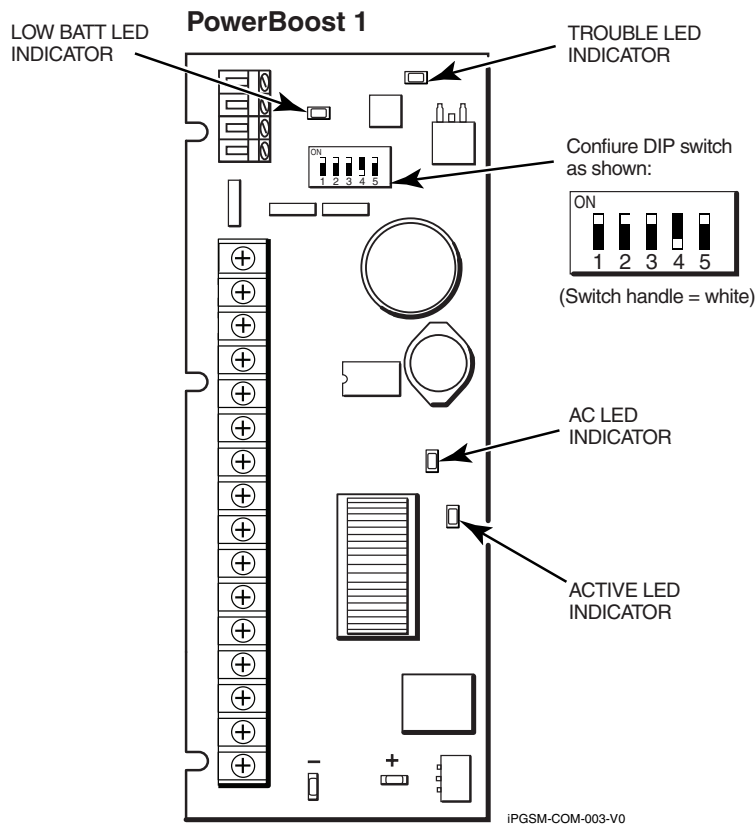

iGSM Communications Module Information

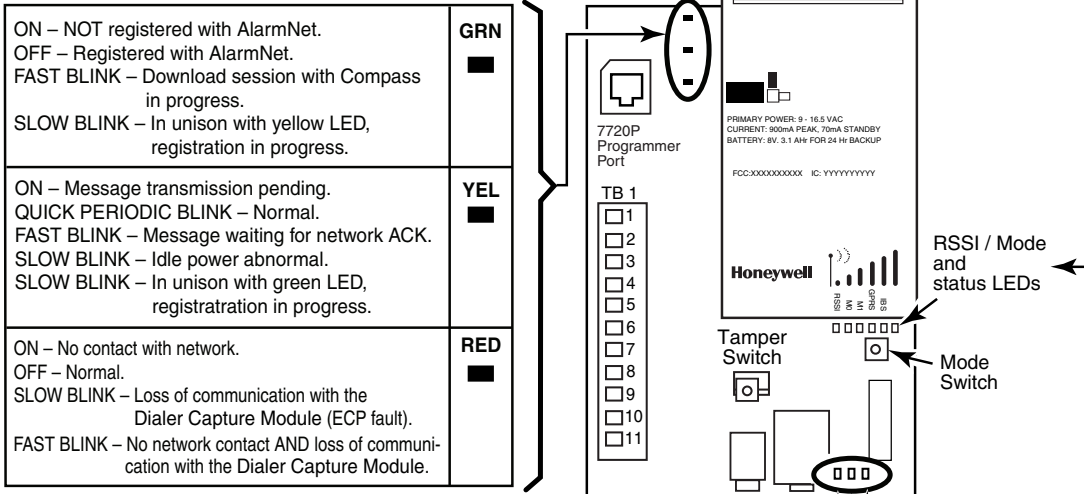

Note: If all LEDs FAST BLINK in unison with the RSSI LEDs this indicates a Hardware Error.

BLINKING – Network collision detected. OFF – Normal.	Network Collision YELLOW
ON – 100 MB/S link to Internet. OFF – 10 MB/S link to Internet.	Link Speed GREEN
ON – Ethernet Link detected. OFF – No link detected. FAST BLINK – Transmitting/Receiving Data.	Ethernet Link/Activity GREEN

MODULE'S RECEIVED SIGNAL STRENGTH (RSSI)

When the **Mode Switch** is NOT depressed, LED 1 will illuminate red.

- The remaining LEDs indicate RSSI (Received Signal Strength).



MODULE'S OPERATION MODE

When the **Mode Switch** IS depressed, LED 1 will be OFF.

- LEDs 2 and 3 indicate the module's communication mode with the Dialer Capture Module.

Mode	LED 2 (yellow)	LED 3 (yellow)
ECP	OFF	OFF
Zone (NOT USED)	ON	OFF
4204 (NOT USED)	OFF	ON
2 - 4204 (NOT USED)	ON	ON

MODULE'S STATUS

When the **Mode Switch** IS depressed, LED 1 will be OFF.

- LEDs 4, 5, and 6 indicate the module's Status.

LED 4 (green)	LED 5 (green)	LED 6 (green)
ON - Connected to Internet.	ON - GPRS service available.	ON - Module registered, no second site available.
OFF - Not connected to Internet.	OFF - No GPRS service available	OFF - Module not registered with network carrier.
		SLOW BLINK - Module registered, second site available, and low signal strength.
		NORMAL BLINK - Module registered, second site available, acceptable signal strength.
		FAST BLINK - Module registered, second site available, excellent signal strength.

iPGSM-COM-002-V0

iPGSM-COM Specifications

ITEM	SPECIFICATION
Cabinet Dimensions:	Width = 12 3/4 inches Height = 14 7/8 inches Depth = 3 inches
Transformer: (N8167)	Primary – 120VAC, 60Hz, 0.50A Secondary – 18VAC, 50VA
Battery:	12V, 7Ah sealed lead acid type (not supplied) Use a Honeywell 712BNP, Yuasa NP7-12 or equivalent.
Battery Charging Current:	maximum 1A
Supervision:	The AC power, backup battery, IP communications, and GSM communications are monitored.

NOTES

Wiring Diagram

The wiring diagram below is depicted for point-to-point electrical connection checks used for troubleshooting or component replacement. It is not intended to show the physical routing of wires. When replacing a wire or component, ensure the wire is routed in the same manner as the original factory wire.

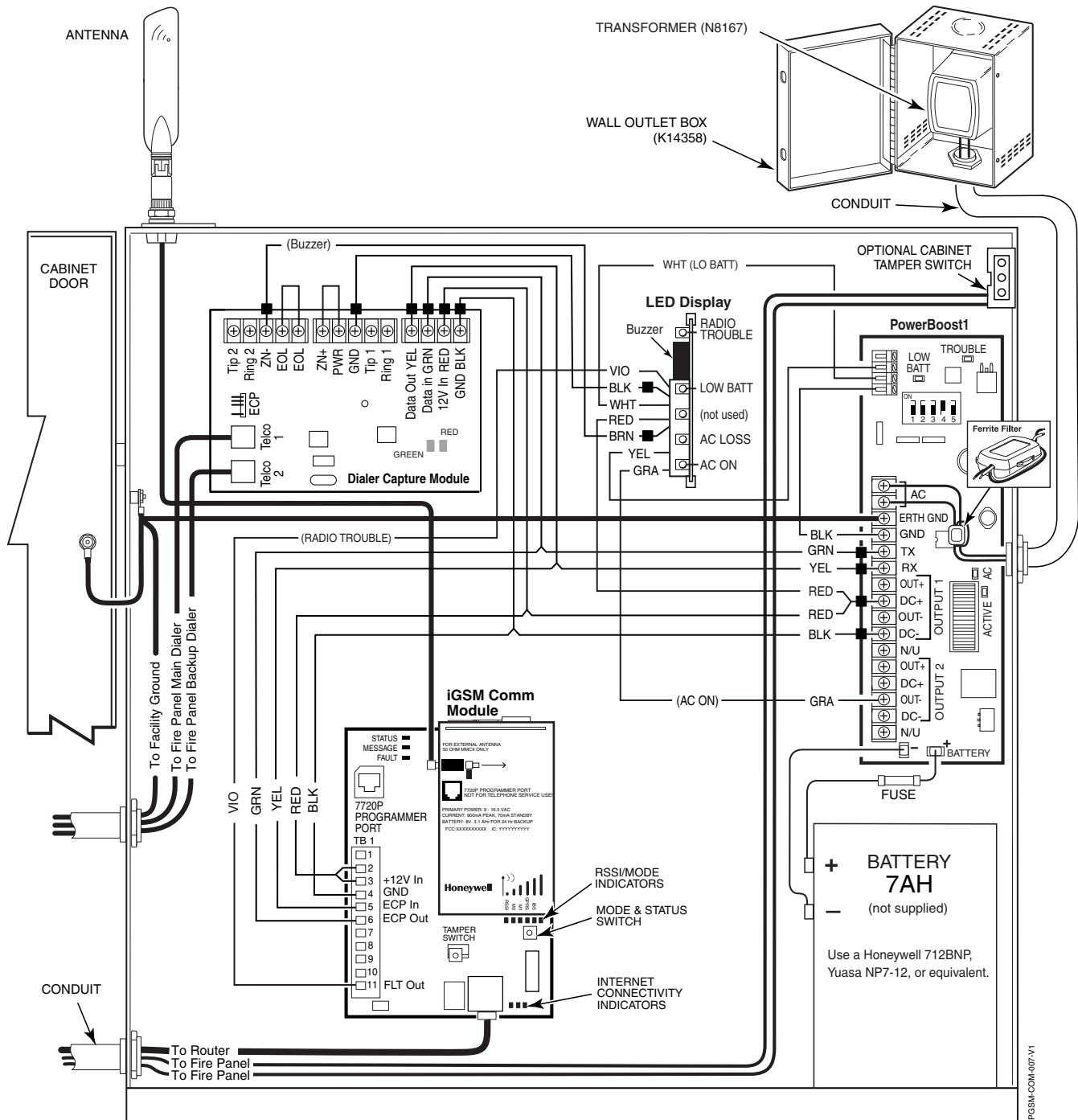

NOTES:

- All circuits are power limited except the backup battery which is non-power limited.
- The non-power limited wiring must be separated from the power limited wiring by at least 1/4 inch.
- If desired, use a Honeywell 955WH Tamper Switch with the 28-2 bracket.

FCC STATEMENT

Note: This equipment has been tested and found to comply with the limits for a Class A digital device, pursuant to part 15 of the FCC Rules. These limits are designed to provide reasonable protection against harmful interference when the equipment is operated in a commercial environment.

This equipment generates, uses, and can radiates radio frequency energy and, if not installed and used in accordance with the instruction manual, may cause harmful interference to radio communications. Operation of this equipment in a residential area is likely to cause harmful interference in which case the user will be required to correct the interference at his own expense.

FCC STATEMENT

This device complies with Part 15 of the FCC Rules, and RSS 210 of IC. Operation is subject to the following two conditions: (1) This device may not cause harmful interference (2) This device must accept any interference received, including interference that may cause undesired operation.

The user shall not make any changes or modifications to the equipment unless authorized by the Installation Instructions or User's Manual. Unauthorized changes or modifications could void the user's authority to operate the equipment.

DOCUMENTATION AND ONLINE SUPPORT

For the latest documentation and online support information, please go to:

<http://www.security.honeywell.com/hsc/resources/MyWebTech/>

WARRANTY

For the latest warranty information, please go to:

<http://www.security.honeywell.com/hsc/resources/wa/>

Honeywell

2 Corporate Center Drive, Suite 100,
P.O. Box 9040, Melville, NY 11747

Copyright © 2010 Honeywell International Inc.

www.honeywell.com/security



800-04433V1 12/10 Rev. A

Free Manuals Download Website

<http://myh66.com>

<http://usermanuals.us>

<http://www.somanuals.com>

<http://www.4manuals.cc>

<http://www.manual-lib.com>

<http://www.404manual.com>

<http://www.luxmanual.com>

<http://aubethermostatmanual.com>

Golf course search by state

<http://golfingnear.com>

Email search by domain

<http://emailbydomain.com>

Auto manuals search

<http://auto.somanuals.com>

TV manuals search

<http://tv.somanuals.com>