



**SILENT
KNIGHT**

by Honeywell

INTELLIKNIGHT[®] 5820XL

Addressable Fire System



**Installation and
Operations Manual**

Part Number 151209 Rev R
ECN 09- 570 08/27/09

Installation Procedure

Adherence to the following will aid in problem-free installation with long-term reliability:

Installation Precautions - Adherence to the following will aid in problem-free installation with long-term reliability: **WARNING** - Several different sources of power can be connected to the fire alarm control panel. Disconnect all sources of power before servicing. Control unit and associated equipment may be damaged by removing and/or inserting cards, modules, or interconnecting cables while the unit is energized. Do not attempt to install, service, or operate this unit until manuals are read and understood. **CAUTION** - System Re-acceptance Test after Software Changes: To ensure proper system operation, this product must be tested in accordance with NFPA 72 after any programming operation or change in site-specific software. Re-acceptance testing is required after any change, addition or deletion of system components, or after any modification, repair or adjustment to system hardware or wiring. All components, circuits, system operations, or software functions known to be affected by a change must be 100% tested. In addition, to ensure that other operations are not inadvertently affected, at least 10% of initiating devices that are not directly affected by the change, up to a maximum of 50 devices, must also be tested and proper system operation verified. This system meets NFPA requirements for operation within the range of 0°C-49°C (32°F-120°F) or humidity within the range of 10%-93% at 30°C (86°F) noncondensing. However, the useful life of the system's standby batteries and the electronic components may be adversely affected by extreme temperature ranges and humidity. Therefore, it is recommended that this system and its peripherals be installed in an environment with a normal room temperature of 15-27° C/60-80° F. **Verify that wire sizes are adequate** for all initiating and indicating device loops. Most devices cannot tolerate more than a 10% I.R. drop from the specified device voltage. **Like all solid state electronic devices**, this system may operate erratically or can be damaged when subjected to lightning induced transients. Although no system is completely immune from lightning transients and interference, proper grounding will reduce susceptibility. Overhead or outside aerial wiring is not recommended, due to an increased susceptibility to nearby lightning strikes. Consult with the Technical Services Department if any problems are anticipated or encountered. **Disconnect AC power and batteries** prior to removing or inserting circuit boards. Failure to do so can damage circuits. Remove all electronic assemblies prior to any drilling, filing, reaming, or punching of the enclosure. When possible, make all cable entries from the sides or rear. Before making modifications, verify that they will not interfere with battery, transformer, or printed circuit board location. **Do not tighten screw terminals** more than 9 in-lbs. Over-tightening may damage threads, resulting in reduced terminal contact pressure and difficulty with screw terminal removal. Silent Knight fire alarm control panels contain static-sensitive components. Always ground yourself with a proper wrist strap before handling any circuits so that static charges are removed from the body. Use static suppressive packaging to protect electronic assemblies removed from the unit.

Follow the instructions in the installation, operating, and programming manuals. These instructions must be followed to avoid damage to the control panel and associated equipment.

FACP operation and reliability depend upon proper installation.

While installing a fire alarm system may make lower insurance rates possible, it is not a substitute for fire insurance! **An automatic fire alarm system** - typically made up of smoke detectors, heat detectors, manual pull stations, audible warning devices, and a fire alarm control with remote notification capability - can provide early warning of a developing fire. Such a system, however, does not assure protection against property damage or loss of life resulting from a fire. **Any fire alarm system** may fail for a variety of reasons: Smoke detectors may not sense fire where smoke cannot reach the detectors such as in chimneys, in walls, or roofs, or on the other side of closed doors. **Smoke detectors** also may not sense a fire on another level or floor of a building. A second floor detector, for example, may not sense a first floor or basement fire. Furthermore, all types of smoke detectors, including ionization and photoelectric types, have sensing limitations. No type of smoke detector can sense every kind of fire caused by carelessness and safety hazards like smoking in bed, violent explosions, escaping gas, improper storage of flammable materials, overloaded electrical circuits, children playing with matches, or arson.

IMPORTANT! Smoke detectors must be installed in the same room as the control panel and in rooms used by the system for the connection of alarm transmission wiring, communications, signaling, and/or power. If detectors are not so located, a developing fire may damage the alarm system, crippling its ability to report a fire. **Audible warning devices** such as bells may not alert people if these devices are located on the other side of closed or partly open doors or are located on another floor of a building. **A fire alarm system** will not operate without any electrical power. If AC power fails, the system will operate from standby batteries only for a specified time. **Rate-of-Rise heat detectors** may be subject to reduced sensitivity over time. For this reason, the rate-of-rise feature of each detector should be tested at least once per year by a qualified fire protection specialist. **Equipment used in the system** may not be technically compatible with the control. It is essential to use only equipment listed for service with your control panel. **Telephone lines** needed to transmit alarm signals from a premise to a central monitoring station may be out of service or temporarily disabled. **The most common cause** of fire alarm malfunctions, however, is inadequate maintenance. All devices and system wiring should be tested and maintained by professional fire alarm installers following written procedures supplied with each device. System inspection and testing should be scheduled monthly or as required by National and/or local fire codes. Adequate written records of all inspections should be kept.

Contents

Section 1

Introduction 1-1

- 1.1 Overview of Basic System 1-1
 - 1.1.1 Hardware Features 1-1
 - 1.1.2 Software Features 1-2
- 1.2 About this Manual 1-2
 - 1.2.1 Terms Used in this Manual 1-2
- 1.3 Compatible Products 1-3
- 1.4 How to Contact Silent Knight 1-4
 - Limitations of Fire Alarm Systems 1-5
 - Requirements and recommendations for proper use of fire alarm systems including smoke detectors and other fire alarm devices: 1-7

Section 2

Agency Listings, Approvals, and Requirements 2-1

- 2.1 Federal Communications Commission (FCC) 2-1
- 2.2 Underwriters Laboratories (UL) 2-2
 - 2.2.1 Requirements for All Installations 2-2
 - 2.2.2 Requirements for Central Station Fire Alarm Systems 2-3
 - 2.2.3 Requirements for Local Protected Fire Alarm Systems 2-3
 - 2.2.4 Requirements for Remote Station Protected Fire Alarm Systems - Digital Alarm Communicator Transmitter (DACT) 2-3

Section 3

Before You Begin Installing 3-1

- 3.1 What's in the Box? 3-1
- 3.2 Environmental Specifications 3-1
- 3.3 Electrical Specifications 3-2
- 3.4 Wiring Specifications 3-3
- 3.5 Board Assembly Diagram 3-5
- 3.6 Calculating Current Draw and Standby Battery 3-6
 - 3.6.1 Current Draw Worksheet Requirements 3-6
 - 3.6.2 Current Draw Worksheet for SK SLC Devices 3-7
 - 3.6.3 Current Draw Worksheet for Hochiki SLC Devices 3-10
 - 3.6.4 Maximum Battery Standby Load 3-12
- 3.7 Installation Tasks Overview 3-12

Section 4

Control Panel Installation 4-1

4.1	Mounting the Control Panel Cabinet	4-1
4.1.1	Preventing Water Damage	4-1
4.1.2	Removing the 5820XL Assembly from the Housing	4-1
4.2	AC Connection	4-2
4.3	Battery Connection	4-3
4.3.1	RBB Accessory Cabinet	4-4
4.3.1.1	Installing the RBB Accessory Cabinet and Batteries	4-4
4.4	SBUS Wiring	4-6
4.4.1	Calculating Wiring distance for SBUS modules	4-6
	Wiring Distance calculation example:	4-8
4.4.2	Wiring Configurations	4-9
4.5	Remote Annunciator 5860 Installation	4-10
4.5.1	Mounting the 5860	4-11
4.5.1.1	Flush Mounting	4-12
	Flush Mounting with an Electrical Box	4-13
	Flush Mounting Steps	4-13
4.5.1.2	Surface Mounting	4-14
4.5.2	Model 5860 Connection to the Panel	4-15
4.6	5815XL Installation	4-16
4.6.1	5815XL Connection to the Panel	4-17
4.7	5824 Serial/Parallel Interface Module Installation	4-18
4.7.1	Selecting 5824 Options	4-19
	Printer and Output Port Options	4-20
4.8	5880 LED I/O Module	4-21
4.8.1	5880 Board Layout	4-21
4.8.2	FACP Connection	4-22
4.8.3	LED Wiring	4-23
4.8.4	Dry Contact Wiring	4-24
4.9	5865-3 / 5865-4 LED Annunciator Installation	4-25
4.9.1	FACP Connection	4-26
4.9.2	5865 Mounting	4-27
4.10	Configuring Modules	4-28
4.10.1	Assigning Module IDs	4-28
4.11	Telephone Connection	4-29
4.12	5211 Ground Start Relay	4-29
4.13	Flexputs™ I/O Circuits	4-30
4.13.1	Conventional Notification Appliance	4-30
4.13.1.1	Regulated Class B Notification Wiring	4-30
4.13.1.2	Class A Notification Wiring	4-32
4.13.2	Conventional Input Switch Circuits	4-33
4.13.2.1	Class B Inputs	4-33
4.13.2.2	Class A Inputs	4-34
4.13.3	Installing 2-Wire Smoke Detectors	4-35
4.13.3.1	Installing 2-Wire Class B Smoke Detectors	4-35
4.13.3.2	Installing 2-Wire Class A Smoke Detector	4-36
4.13.4	Installing 4-Wire Smoke Detectors	4-37
4.13.4.1	Installing a Class B 4-Wire Smoke Detector	4-37
4.13.4.2	Installing 4-Wire Class A Smoke Detectors	4-38

4.13.5 Auxiliary Power Installation	4-39
4.13.5.1 Door Holder Power	4-39
4.13.5.2 Constant Power	4-39
4.13.5.3 Resettable Power	4-40
4.14 On-Board Relays (Conventional)	4-40
4.14.1 Trouble Relay	4-40
4.14.2 Programmable Relays	4-40
4.15 Remote Station Applications	4-41
4.15.1 Keltron Model 3158 Installation	4-41
4.15.2 City Box Connection Using the 5220 Module	4-42
4.15.3 NFPA 72 Polarity Reversal	4-43
4.15.3.1 Using the 5220 Module	4-43
4.15.3.2 Using the 7644 Module	4-44
4.15.4 Using the SD500-ARM Addressable Relay Module	4-45
4.15.5 Using a MR-201/T Control Relay From Air Products	4-46
4.15.6 Transmitter Activated by Dry Contacts	4-47

Section 5

Hochiki and SK SLC Device Installation 5-1

5.1 List of SK SLC Devices	5-1
5.2 List of Hochiki SLC Devices	5-2
5.3 Maximum Number of Devices	5-3
5.4 Wiring Requirements for SLC Devices	5-3
5.4.1 Wiring 5815XL in Style 4 (Class B) Configuration	5-3
5.4.2 Wiring 5815XL in Style 6 & 7 (Class A) Configuration	5-5
5.5 Wiring SK SLC Detectors	5-6
5.6 Addressing SK SLC Devices	5-7
5.7 Hochiki Detector Installation	5-8
5.7.1 Wiring Hochiki Detectors	5-8
5.8 Addressing Hochiki Devices	5-9
5.8.1 SD505-APS, SD505-AHS, & SD505-AIS	5-9
5.8.2 SLC Devices with Dip Switches	5-10

Section 6

Programming Overview 6-1

6.1 JumpStart Autoprogramming	6-1
6.1.1 Input Points	6-2
6.1.2 Output Points	6-2
6.1.3 Running JumpStart	6-2
6.2 Mapping Overview	6-4
6.2.1 Input Point Mapping	6-5
6.2.2 Output Circuit Mapping	6-6
6.2.3 Zone Event Mapping	6-7
6.2.4 Mapping LED Points	6-9
6.3 Programming Using the 5660 Silent Knight Software Suite	6-10
6.4 Programming Using an Annunciator	6-10

6.4.1	Entering & Exiting the Program Menu	6-11
6.4.1.1	Moving through the Menus	6-11
6.4.1.2	Selecting Options and Entering Data	6-12
6.4.1.3	Editing Keys	6-12
6.5	Programming Menu Quick Reference	6-13

Section 7

Programming 7-1

7.1	UL 864 Programming Requirements	7-1
7.2	SLC Family	7-2
7.3	Modules	7-2
7.3.1	Edit Modules	7-3
7.3.1.1	Naming Modules	7-3
7.3.1.2	Setting the 5815XL Wiring Class	7-4
7.3.2	Adding a Module	7-4
7.3.3	Deleting a Module	7-5
7.4	Zone	7-5
7.4.1	Edit Zone	7-5
7.4.1.1	Edit Zone Name	7-6
7.4.1.2	Edit Zone Properties	7-6
	Alarm Delay Characteristics	7-7
	Heat Temperature Setting	7-7
7.4.1.3	Zone Outputs	7-8
	Mapping to Zone Events	7-8
	Zone Mapping Example	7-9
7.4.1.4	Cadence Patterns	7-11
7.4.1.5	Zone Accessory Options	7-11
7.4.2	Add Zone	7-12
7.4.3	Delete Zone	7-12
7.4.4	View Zone Points	7-13
7.5	Group	7-14
7.5.1	Edit Group	7-14
7.5.1.1	Edit Group Name	7-14
7.5.1.2	Edit Group Properties	7-15
	Latching / Non-latching Outputs	7-15
	Silencing Options	7-15
	Response with System-Wide Conditions	7-16
7.5.2	Add Group	7-17
7.5.3	Delete Group	7-17
7.5.4	View Group Points	7-18
7.5.5	Edit Output Group Templates	7-18
7.6	Point	7-19
7.6.1	Point Programming For 5815XL Module	7-19
7.6.2	Point Programming For Internal or External Power Module (5895XL)	7-24
7.6.3	Point Programming For 5880 and 5865 Modules	7-26

7.6.3.1	Assigning a Name to Points	7-27
7.7	System Options	7-27
7.7.1	Reporting Account	7-28
7.7.1.1	Edit Accounts	7-29
	Select Account (ID)	7-29
	Edit Account Number	7-29
	Select Reporting Format	7-29
	Events to Report	7-30
	Switch Attempts	7-30
	Fail Attempts	7-30
	Selecting Primary and Secondary Phone Lines	7-30
	Telephone Number	7-31
7.7.1.2	Auto Test Time	7-32
7.7.2	Phone Lines	7-32
7.7.2.1	Dialing Prefix	7-33
7.7.2.2	Number of Answer Rings	7-34
7.7.2.3	Dial Option (TouchTone or Pulse)	7-34
7.7.2.4	Rotary Format	7-34
7.7.2.5	Line Monitor	7-34
7.7.2.6	Ground Start Relay	7-34
7.7.2.7	Answering Machine Bypass	7-35
7.7.3	Sys. Event Outputs	7-35
7.7.3.1	Trouble Events	7-36
7.7.3.2	System Alarm Cadence	7-37
7.7.4	Miscellaneous Options 1	7-38
7.7.4.1	Water Flow Delay	7-38
7.7.4.2	Low AC Report Delay	7-40
7.7.4.3	Automatic Daylight Savings Adjustment	7-40
7.7.4.4	Clock Display Format (AM/PM or Military)	7-40
7.7.4.5	Change AC Line Frequency	7-40
7.7.5	Miscellaneous Options 2	7-41
7.7.5.1	Synchronize Strobes Active During Silence	7-41
7.7.5.2	Auto Display Oldest Event	7-41
7.7.5.3	Report by Zone or by Point	7-41
7.7.6	Miscellaneous Options 3	7-42
7.7.6.1	Alarm Verification Time	7-42
7.7.6.2	Plex Door Option	7-42
7.7.6.3	Daylight Saving Time Start and End	7-43
7.7.7	Edit Banner Message	7-44
7.8	JumpStart Autoprogramming	7-45
7.9	Computer Account	7-46

7.10	Access Codes	7-47
7.10.1	Profile Edit Menu	7-48
7.10.1.1	Edit Name	7-48
7.10.1.2	Edit Access Code	7-48
7.10.1.3	Panel Functions	7-48

Section 8

System Operation 8-1

8.1	User and Installer Default Codes	8-1
8.2	Annunciator Description	8-1
8.2.1	LCD Displays	8-2
8.2.2	Banner	8-2
8.3	Key Operation	8-2
8.4	Menu System	8-3
8.4.1	Main Menu Overview	8-3
8.4.2	Using the Menus	8-4
8.5	Basic Operation	8-4
8.5.1	Setting Time and Date	8-4
8.5.2	Disable / Enable a Point	8-4
8.5.3	Disable / Enable NACs by Group	8-4
8.5.4	View Event History	8-5
8.5.4.1	To clear the event history	8-5
8.5.5	Conduct a Fire Drill	8-5
8.5.6	Conduct an Indicator Test	8-5
8.5.7	Conduct a Walk Test	8-6
8.5.8	Conduct a Dialer Test	8-6
8.5.9	Silence alarms or troubles	8-7
8.5.10	Reset alarms	8-7
8.5.11	Check Detector Through Point Status	8-7
8.5.12	View Status of a Point	8-8
8.5.13	View Alarms or Troubles	8-8
8.5.14	View System Information	8-8
8.5.15	Reset dialer	8-8
8.5.16	Communicating with a Remote Computer	8-9
8.5.17	Working with a Printer	8-10
8.6	Operation Mode Behavior	8-11
8.7	Releasing Operations	8-14
8.7.1	Single Interlock Zone Releasing	8-15
	Conditions Required for an Pre-Alert Output Activation	8-15
	Conditions required for an General Alarm and Release Output Activation	8-15

8.7.2	Double Interlock Zone Releasing	8-16
	Conditions Required for a Pre-Alert Output Activation	8-16
	Conditions Required for a General Alarm Output Activation	8-16
	Conditions Required for a Release Output Activation	8-16
8.8	Smoke Alarm Verification	8-17

Section 9

Reporting	9-1
------------------------	-----

9.1	Receivers Compatible with the Control Panel	9-1
9.2	Reporting Formats Dialer Outputs	9-1

Section 10

Testing and Troubleshooting	10-1
--	------

10.1	Troubleshooting	10-1
10.2	Common Problems	10-1
10.2.1	Periodic Testing And Maintenance	10-2
10.2.2	Event History	10-3
10.3	Built-in Troubleshooting and Testing Tools	10-4
10.3.1	SLC Device Locator	10-4
10.3.2	SLC Multi Locator	10-5
10.3.3	I/O Point Control	10-6
10.3.4	Earth Fault Resistance	10-7

Section 11

Installation Records	11-1
-----------------------------------	------

11.1	SLC Point Record	11-1
11.2	Conventional Output Point Record	11-8

Appendix A

Compatible Devices	A-1
---------------------------------	-----

A.1	Notification Appliances	A-1
A.2	Two-Wire Smoke Detectors	A-12

Appendix B

Special Characters Lists	B-1
---------------------------------------	-----

B.1	Characters used for Naming	B-1
-----	----------------------------------	-----

Silent Knight Fire Product Warranty and Return Policy

Section 1

Introduction

The IntelliKnight 5820XL Fire Alarm Control/Communicator is an addressable fire control system that meets the requirements of UL 864.

1.1 Overview of Basic System

The IntelliKnight 5820XL base system is packaged as an assembled stack of 3 circuit boards mounted to an aluminum housing.

1.1.1 Hardware Features

- The IntelliKnight 5820XL panel has one signaling line circuit (SLC). Up to three additional SLC loops can be added using the 5815XL SLC expander. The SLC(s) support the SK series addressable detectors and modules or Hochiki protocol detectors and modules.
- Each SLC supports up to 99 detectors and 99 modules for a total of 396 detectors and 396 modules per 5820XL panel when using SK series devices. Alternatively, each SLC supports up to 127 Hochiki devices for a total of 508 devices per 5820XL panel.
- 6.0A of output power is available through 6 sets of terminals for notification and auxiliary applications. Each circuit is power limited per UL 864 and can source up to 3.0A (total output power for all 6 circuits must not exceed 6.0A).
- Built-in dual phone line, digital alarm communicator/transmitter (DACT).
- Reports events to central station by point or by zone.
- UL Listed for pre-action and deluge releasing systems.
- Dedicated Form C trouble relay and two general purpose Form C programmable relays.
- Basic system operation can be performed using a key or a user code.
- Can be used with up to 8 Model 5860 Remote Annunciators (sold separately).
- Supports the 5865-3, 5865-4, and 5880 in any combination for a total of eight devices on one control panel. See sections 4.8 and 4.9 for additional information on these models.
- Printing of detector status, event history, and real time event log available through the Model 5824 Serial/Parallel Printer Interface Module (sold separately).
- Supports conventional 2-wire & 4-wire detectors using the 6 Flexput™ circuits.
- Add 6 Flexput™ circuits with each 5895XL Intelligent Power Module (up to 8 5895XLs per system). See note below.
- Add 4 notification/auxiliary power circuits with each 5496 Intelligent Power Module. See note below.

Note: The system can support a maximum of eight Intelligent Power modules, either the 5895XL or 5496, in any combination.

1.1.2 Software Features

- 125 software zones, 250 output groups.
- Advanced smoke detector features:
 - Automatic drift compensation
 - Maintenance alert region
 - Point status eliminates calibrated smoke test requirements for NFPA 72
- “JumpStart” feature for easy programming
- Non-volatile event history stores 1000 events
- A choice of output patterns available for notification outputs, including ANSI 3.41 temporal signal
- Built-in synchronization appliance support for AMSECO, Faraday, Gentex[®], System Sensor[®], and Wheelock[®].

1.2 About this Manual

This manual is intended to be a complete reference for all installation and operation tasks for the 5820XL. Please let us know if the manual does not meet your needs in any way. We value your feedback!

1.2.1 Terms Used in this Manual

The following terminology is used with the IntelliKnight 5820XL system:

Table 1-1 Manual Terminology

Term	Description
SLC	Signaling line circuit
Module	The term module is used for all hardware devices except for SLC addressable devices and notification appliances. This includes the 5820XL panel itself and the built-in 5897 power supply. It also refers to any (optional) 5815XL SLC expansion modules.
Input Point	An addressable sensing device, such as a smoke or heat detector or a contact monitor device.
Input Zone	A protected area made up of input points.
Output Point (or Output Circuit)	A notification point or circuit for notification appliances. Relay circuits and auxiliary power circuits are also considered output points.
Group (or “Output Group”)	A group of output points. Operating characteristics are common to all output points in the group.
Output (or “Cadence”) Pattern	The pattern that the output will use, for example, Constant, March Code, ANSI 3.41. Applies to zones and special system events. See Section 7.7.3.2 for additional information.
Mapping	Mapping is the process of specifying which outputs are activated when certain events occur in the system. Section 6.2 explains mapping in detail.

1.3 Compatible Products

Table 1-2 lists the products available from Silent Knight for use with the IntelliKnight 5820XL.

Table 1-2: 5820XL Compatible Products

Type of Device	Model	Description	
Addressable SLC Devices	See Section 5.2 for a list of compatible devices.		
Other Modules	5815XL SLC Expander	Allows an additional 127 Hochiki SLC devices, or 99 SK detectors and 99 SK modules to be added to the system. Up to three 5815XLs per system.	
	5211 Ground Start Relay	For use with ground start telephone network. (Do not use in UL installations.)	
	5824 Serial/Parallel Printer Interface Module	Allows a printer to be attached for the system for on-site event logging, detector status and event history reports. Two maximum per system.	
	5895XL Intelligent Power Module	Provides additional power, six Flexput™ circuits, and two Form C relays. Max. 8 per system see <i>Model 5895 Installation Instructions P/N 151024</i> .	5895XLs and 5496s can be used in any combination, up to a total of eight devices on one system.
	5496 Intelligent Power Module	Provides 4 additional Notification Appliance Circuits/ Auxiliary power. (Up to 8 per system.)	
	5860 and 5860R Remote Fire Alarm Annunciator	Same operation, similar appearance as on-board annunciator. Up to 8 5860s per system. 5860 is gray; 5860R is red.	
	5860TG and 5860TR Trim Ring Kit	Trim ring kits for surface mounting the 5860 annunciator. 5860TG is gray; 5860TR is red.	
	5865-3 and 5865-4 LED Annunciator	LED annunciator can display up to 30 LEDs (15 red and 15 yellow). 5865-4 has key switches for silence and reset, and a system trouble LED.	5865-3, 5865-4, and 5880 can be used in any combination, up to a total of eight devices on one panel.
	5880 LED I/O Module	Driver for up to 40 LEDs. Interfaces with customized annunciator boards. In addition the 5880 has eight generic switch input points.	
	5883 General Purpose Relay Module	Provides 10 Form C relays. Designed to be driven by the 5880. Up to four, 5883s can be used with each 5880 module.	
Misc.	7860 Telephone Cord	RJ31X cord for connecting phone line to the 5820XL.	
	5660 Silent Knight Software Suite (SKSS)	For communication and panel programming with a Windows-based computer and *modem (not sold by Silent Knight, see Table 1-3 for compatible modems). Enables remote viewing of detector status and event history.	
	5670 Silent Knight Software Suite (SKSS)	Facility management software. For remote viewing of detector status and event history. Requires a modem (not sold by Silent Knight).	
	RBB	Remote Battery Box for mounting backup batteries that are too large to fit into the main control panel cabinet. Dimensions: 16" W x 10" H x 6" D (40.64 cm W x 25.4 cm H x 15.24 cm D)	

Note: Models SD500-FRCM, and SD500-FRCM-4 are no longer manufactured, but they are still compatible with the IntelliKnight system. Contact Silent Knight if you need information about these modules.

The following modems have been tested by Silent Knight for compatibility with the 5820XL and the Silent Knight Software Suite software packages:

Table 1-3: Compatible Modems

Manufacturer	Model
US Robotics	28.8
Motorola	LifeStyle
	28.8, 3400 series
	Premier 33.6
MultiTech	MT19321ZDX

1.4 How to Contact Silent Knight

If you have a question or encounter a problem not covered in this manual, contact Silent Knight Technical Support at 800-446-6444.

To order parts, contact Silent Knight Customer Service at 800-328-0103 or in Connecticut 203-484-7161.

IntelliKnight[®] is a registered trademarks of Silent Knight. Flexput[™] is a trademark of Silent Knight.

Limitations of Fire Alarm Systems

Manufacturer recommends that smoke and/or heat detectors be located throughout a protected premise following the recommendations of the current edition of the National Fire Protection Association Standard 72 (NFPA 72), manufacturer's recommendations, State and local codes, and the recommendations contained in Guide for the Proper Use of System Smoke Detectors, which is made available at no charge to all installing dealers. A study by the Federal Emergency Management Agency (an agency of the United States government) indicated that smoke detectors may not go off or give early warning in as many as 35% of all fires. While fire alarm systems are designed to provide warning against fire, they do not guarantee warning or protection against fire. A fire alarm system may not provide timely or adequate warning, or simply may not function, for a variety of reasons. For example:

- Particles of combustion or smoke from a developing fire may not reach the sensing chambers of smoke detectors because:

Barriers such as closed or partially closed doors, walls, or chimneys may inhibit particle or smoke flow.

Smoke particles may become cold, stratify, and not reach the ceiling or upper walls where detectors are located.

Smoke particles may be blown away from detectors by air outlets

Smoke particles may be drawn into air returns before reaching the detector.

In general, smoke detectors on one level of a structure cannot be expected to sense fires developing on another level.

- The amount of smoke present may be insufficient to alarm smoke detectors. Smoke detectors are designed to alarm at various levels of smoke density. If such density levels are not created by a developing fire at the location of detectors, the detectors will not go into alarm.
- Smoke detectors, even when working properly, have sensing limitations. Detectors that have photoelectronic sensing chambers tend to detect smoldering fires better than flaming fires, which have little visible smoke. Detectors that have ionizing-type sensing chambers tend to detect fast flaming fires better than smoldering fires. Because fires develop in different ways and are often unpredictable in their growth, neither type of detector is necessarily best and a given type of detector may not provide adequate warning of a fire.
- Smoke detectors are subject to false alarms and nuisance alarms and may have been disconnected by users. For example, a smoke detector located in or near a kitchen may go into nuisance alarm during normal operation of kitchen appliances. In addition, dusty or steamy environments may cause a smoke detector to falsely alarm. If the location of a smoke detector causes an abundance of false alarms or nuisance alarms, do not disconnect the smoke detector; call a professional to analyze the situation and recommend a solution.
- Smoke detectors cannot be expected to provide adequate warning of fires caused by arson, children playing with matches (especially within bedrooms), smoking in bed, violent explosions (caused by escaping gas, improper storage of flammable materials, etc.).

- Heat detectors do not sense particles of combustion and are designed to alarm only when heat on their sensors increases at a predetermined rate or reaches a predetermined level. Heat detectors are designed to protect property, not life.
- Warning devices (including horns, sirens, and bells) may not alert people or wake up sleepers who are located on the other side of closed or partially open doors. A warning device that activates on a different floor or level of a dwelling or structure is less likely to awaken or alert people. Even persons who are awake may not notice the warning if the alarm is muffled by noise from a stereo, radio, air conditioner or other appliance, or by passing traffic. Audible warning devices may not alert the hearing-impaired (strobes or other devices should be provided to warn these people). Any warning device may fail to alert people with a disability, deep sleepers, people who have recently used alcohol or drugs, or people on medication or sleeping pills.

Please note that:

- i) Strobes can, under certain circumstances, cause seizures in people with conditions such as epilepsy.
 - ii) Studies have shown that certain people, even when they hear a fire alarm signal, do not respond or comprehend the meaning of the signal. It is the property owner's responsibility to conduct fire drills and other training exercises to make people aware of fire alarm signals and instruct on the proper reaction to alarm signals.
 - iii) In rare instances, the sounding of a warning device can cause temporary or permanent hearing loss.
- Telephone lines needed to transmit alarm signals from a premises to a central station may be out of service or temporarily out of service. For added protection against telephone line failure, backup radio transmission systems are recommended.
 - System components, though designed to last many years, can fail at any time. As a precautionary measure, it is recommended that smoke detectors be checked, maintained, and replaced per manufacturer's recommendations.
 - System components will not work without electrical power. If system batteries are not serviced or replaced regularly, they may not provide battery backup when AC power fails.
 - Environments with high air velocity or that are dusty or dirty require more frequent maintenance.

In general, fire alarm systems and devices will not work without power and will not function properly unless they are maintained and tested regularly.

While installing a fire alarm system may make the owner eligible for a lower insurance rate, an alarm system is not a substitute for insurance. Property owners should continue to act prudently in protecting the premises and the people in their premises and should properly insure life and property and buy sufficient amounts of liability insurance to meet their needs.

Requirements and recommendations for proper use of fire alarm systems including smoke detectors and other fire alarm devices:

Early fire detection is best achieved by the installation and maintenance of fire detection equipment in all rooms and areas of the house or building in accordance with the requirements and recommendations of the current edition of the National Fire Protection Association Standard 72, *National Fire Alarm Code* (NFPA 72), the manufacturer's recommendations, State and local codes and the recommendations contained in Guide for the Proper Use of System Smoke Detectors, which is made available at no charge to all installing dealers. For specific requirements, check with the local Authority Having Jurisdiction (ex. Fire Chief) for fire protection systems.

Requirements and Recommendations include:

- Smoke Detectors shall be installed in sleeping rooms in new construction and it is recommended that they shall also be installed in sleeping rooms in existing construction.
- It is recommended that more than one smoke detector shall be installed in a hallway if it is more than 30 feet long.
- It is recommended that there shall never be less than two smoke detectors per apartment or residence.
- It is recommended that smoke detectors be located in any room where an alarm control is located, or in any room where alarm control connections to an AC source or phone lines are made. If detectors are not so located, a fire within the room could prevent the control from reporting a fire.
- All fire alarm systems require notification devices, including sirens, bells, horns, and/or strobes. In residential applications, each automatic alarm initiating device when activated shall cause the operation of an alarm notification device that shall be clearly audible in all bedrooms over ambient or background noise levels (at least 15dB above noise) with all intervening doors closed.
- It is recommended that a smoke detector with an integral sounder (smoke alarm) be located in every bedroom and an additional notification device be located on each level of a residence.
- To keep your fire alarm system in excellent working order, ongoing maintenance is required per the manufacturer's recommendations and UL and NFPA standards. At a minimum the requirements of Chapter 7 of NFPA 72 shall be followed. A maintenance agreement should be arranged through the local manufacturer's representative. Maintenance should be performed annually by authorized personnel only.
- The most common cause of an alarm system not functioning when a fire occurs is inadequate maintenance. As such, the alarm system should be tested weekly to make sure all sensors and transmitters are working properly.

Section 2

Agency Listings, Approvals, and Requirements

2.1 Federal Communications Commission (FCC)

1. The following information must be provided to the telephone company before the IntelliKnight 5820XL can be connected to the phone lines:

A	Manufacturer:	Silent Knight
B	Model Number:	IntelliKnight 5820XL
C	FCC registration number:	AC6USA-23901-AL-E
	Ringer equivalence:	0.8B
D	Type of jack:	RJ31X
E	Facility Interface Codes:	Loop Start: 02LS2 Ground Start: 02GS2
F	Service Order Code:	9.0F

This equipment complies with Part 68 of the FCC rules and the requirements adopted by ACTA. On the inside cover of this equipment is a label that contains, among other information, a product identifier. If requested, this information must be provided to the telephone company.

A plug and jack used to connect this equipment to the premises wiring and telephone network must comply with the applicable FCC Part 68 rules and requirements adopted by the ACTA. A compliant telephone cord (not provided) and modular jack must be utilized with this product. It is designed to be used with a modular jack that is also compliant.

The REN (ringer equivalence number) provided on this installation sheet is used to determine the number of devices that may be connected to the public switched telephone network. This number must not exceed 5.0. Since this product has an REN of 1.0, the number of devices is limited. The REN number is imbedded in the FCC registration number as 10B.

If the 5820XL causes harm to the telephone network, the telephone company will notify you in advance that the temporary discontinuance of service may be required. But if advance notice is not practical, the telephone company will notify the customer as soon as possible. Also, you will be advised of your right to file a complaint with the FCC if you believe it is necessary.

The telephone company may make changes in its facilities, equipment, operations or procedures that could affect the operation of the equipment. If this happens the telephone company will provide advance notice in order for you to make necessary modifications to maintain uninterrupted service.

If trouble is experienced with the 5820XL, for repair or warranty information, please contact Silent Knight at 1-800-328-0103 or www.silentknight.com. If the equipment is causing harm to the telephone network, the telephone company may request that you disconnect the 5820XL until the problem has been resolved.

This product cannot be adjusted or repaired in the field. It must be returned to the factory for service.

This equipment is not designed for use with party line service. Connection to party line service is subject to state tariffs. You may contact the state public utility commission, public service commission or corporation commission for information.

Since the 5820XL is a commercial fire alarm panel, it must be connected upstream of all other equipment utilizing the phone lines. If you have questions about the installation, contact your telephone company or a qualified installer.

Warning

This device has been verified to comply with FCC Rules Part 15. Operation is subject to the following conditions: (1) This device may not cause radio interference, and (2) This device must accept any interference received, including interference that may cause undesired operation.

2.2 Underwriters Laboratories (UL)

2.2.1 Requirements for All Installations

General requirements are described in this section. When installing an individual device, refer to the specific section of the manual for additional requirements. The following subsections list specific requirements for each type of installation (for example, Central Station Fire Alarm systems, Local Protected Fire Alarm systems, and so on). See Section 8.7 for information on releasing operation.

1. All field wiring must be installed in accordance with NFPA 70 National Electric Code.
2. Use the addressable smoke detectors specified in Section 5.2 of this manual and or conventional detectors listed in the compatibility chart. (See Appendix A.)
3. Use UL listed notification appliances compatible with the 5820XL from those specified in the *Appendix* at the back of this manual.
4. A full system checkout must be performed any time the panel is programmed.

Restricted Options:

- The loss of AC signal is defaulted to 3 hours however the system allows settings from 0 - 30 hours. For UL certified installations this number must be set from 1 to 3 hours.
- The system allows the use of non-latching spot type smoke detectors. This feature may not be used in commercial applications whereby a general alarm is sounded. It is intended for elevator recall, door holding applications, and hotel/motel room applications.
- The system allows the Alarm Verification time to be set from 1 to 255 seconds. For UL certified installations the setting must be a minimum of 60 seconds.
- Call forwarding shall not be used.
- When two count is used detector spacing shall be cut in half, you shall not use the alarm verification feature, and no delay shall be used.
- P.A.S feature shall be used only with automatic detectors.

2.2.2 Requirements for Central Station Fire Alarm Systems

1. Use both phone lines. Enable phone line monitors for both lines.
2. You must program a phone number and a test time so that the 5820XL sends an automatic daily test to the central station.
3. Do not use the ground start option.
4. The AC Loss Hours option must be set from 1-3 hours.
5. The Attempts to Report option must be set for 5.

2.2.3 Requirements for Local Protected Fire Alarm Systems

At least one UL listed supervised notification appliance must be used.

2.2.4 Requirements for Remote Station Protected Fire Alarm Systems - Digital Alarm Communicator Transmitter (DACT)

1. Do not exceed the current load restrictions shown in Section 3.6.
2. The AC Loss Hours option must be set from 15-30 hours.

Section 3

Before You Begin Installing

This section of the manual is intended to help you plan your tasks to facilitate a smooth installation. Please read this section thoroughly, especially if you are installing a 5820XL panel for the first time.

3.1 What's in the Box?

The IntelliKnight 5820XL ships with the following hardware:

- A cabinet with all hardware assembled
- Two keys for the front door
- Two keys for user operation of the on-board annunciator (installer operations require the Installer's Code)
- Ten 4.7K ohm end-of-line resistors
- A battery cable for batteries wired in series

3.2 Environmental Specifications

It is important to protect the 5820XL control panel from water. To prevent water damage, the following conditions should be AVOIDED when installing the units:

- Intended for indoor use in dry locations only
- Do not mount directly on exterior walls, especially masonry walls (condensation)
- Do not mount directly on exterior walls below grade (condensation)
- Protect from plumbing leaks
- Protect from splash caused by sprinkler system inspection ports
- Do not mount in areas with humidity-generating equipment (such as dryers, production machinery)

When selecting a location to mount the 5820XL control panel, the unit should be mounted where it will NOT be exposed to temperatures outside the range of 0°C-49°C (32°F-120°F) or humidity not exceeding 93% noncondensing.

3.3 Electrical Specifications

Terminal # and Label		Description	Rating		Earth Ground Faults	
			Voltage	Current		
1	L	AC input (hot)	120 VAC, 60 Hz	2.5 A	N/A	
2		Earth ground	N/A	N/A	N/A	
3	N	AC input (neutral)	120 VAC 60 Hz	2.5 A	N/A	
4	X	*I/O 6 Flexput™ Circuits	24 VDC	3.0 Amp Notification and Aux power Circuits	0Ω	
5	O			100 mA for initiation circuits		
6	X	*I/O 5 Flexput™ Circuits	24 VDC	3.0 Amp Notification and Aux power Circuits	0Ω	
7	O			100 mA for initiation circuits		
8	X	*I/O 4 Flexput™ Circuits	24 VDC	3.0 Amp Notification and Aux power Circuits	0Ω	
9	O			100 mA for initiation circuits		
10	X	*I/O 3 Flexput™ Circuits	24 VDC	3.0 Amp Notification and Aux power Circuits	0Ω	
11	O			100 mA for initiation circuits		
12	X	*I/O 2 Flexput™ Circuits	24 VDC	3.0 Amp Notification and Aux power Circuits	0Ω	
13	O			100 mA for initiation circuits		
14	X	*I/O 1 Flexput™ Circuits	24 VDC	3.0 Amp Notification and Aux power Circuits	0Ω	
15	O			100 mA for initiation circuits		
16	B	SBUS OUT	SBUS communication	5 VDC	0Ω	
17	A					
18	+		SBUS power	24 VDC		1.0 A
19	-					
20	B	SBUS IN	Used for Class A installations			0Ω
21	A					
22	+					
23	-					
24	N.C.	RELAY 2	General Purpose Relay 2	24 VDC	2.5 A, resistive	N/A
25	C					
26	N.O.					
27	N.C.	RELAY 1	General Purpose Relay 1	24 VDC	2.5 A, resistive	N/A
28	C					
29	N.O.					
30	N.C.	TROUBLE	Trouble Relay	24 VDC	2.5 A, resistive	N/A
31	C					
32	N.O.					
33	SC-	L1	SLC terminals	32 VDC	150 mA	0Ω
34	SC+	SLC OUT				
35	SC-	L2	Used for Class A installations			0Ω
36	SC+	SLC IN				

* Regulated/Special application when used for releasing.

Terminal # and Label		Description	Rating		Earth Ground Faults
			Voltage	Current	
37	Ring	Phone Line 1 Telco Ring	N/A		0Ω
38	Tip	Phone Line 1 Telco Tip			
39	Ring	Phone Line 1 Premises Ring			
40	Tip	Phone Line 1 Premises Tip			
41	Ring	Phone Line 2 Telco Ring	N/A		0Ω
42	Tip	Phone Line 2 Telco Tip			
43	Ring	Phone Line 2 Premises Ring			
44	Tip	Phone Line 2 Premises Tip			
45	SC-	SLC Programming Terminal (-)	32 VDC	150 mA	0Ω
46	SC+	SLC Programming Terminal (+)	32 VDC	150 mA	

3.4 Wiring Specifications

Induced noise (transfer of electrical energy from one wire to another) can interfere with telephone communication or cause false alarms. To avoid induced noise, follow these guidelines:

- Isolate input wiring from high current output and power wiring. Do not pull one multi-conductor cable for the entire panel. Instead, separate the wiring as follows:

High voltage	AC power, Terminals 1-3
SLC loops	Terminals 33-36
Audio input/output	Phone line circuits, Terminals 37-44
Notification circuits	Terminals 4-15
SBUS	Terminals 16-23
Relay circuits	Terminals 24-32

- Do not pull wires from different groups through the same conduit. If you must run them together, do so for as short a distance as possible or use shielded cable. Connect the shield to earth ground at the panel. You must route high and low voltages separately.
- Route the wiring around the inside perimeter of the cabinet. It should not cross the circuit board where it could induce noise into the sensitive microelectronics or pick up unwanted RF noise from the high speed circuits. See Figure 3-1 for an example.
- High frequency noise, such as that produced by the inductive reactance of a speaker or bell, can also be reduced by running the wire through ferrite shield beads or by wrapping it around a ferrite toroid.

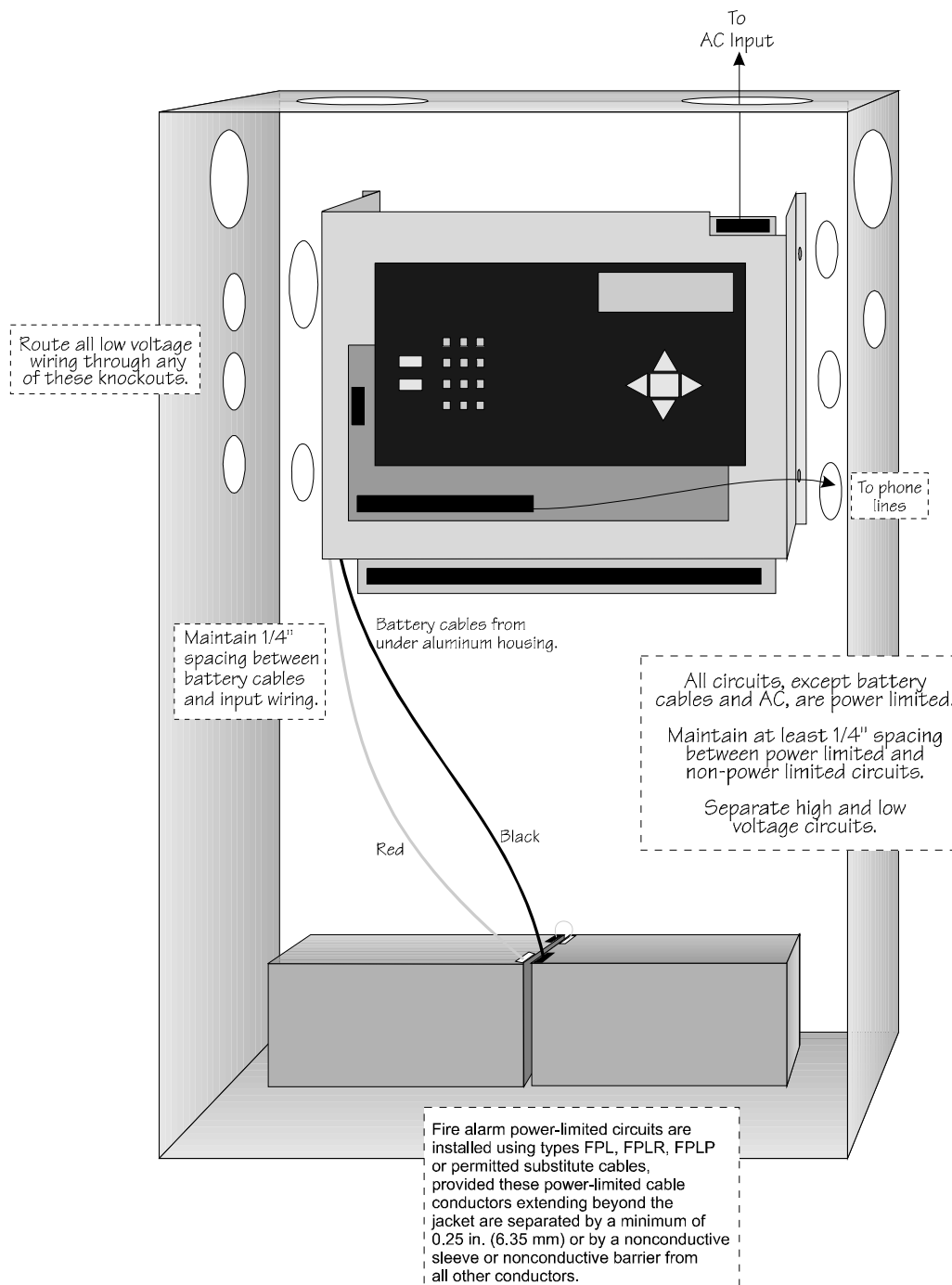

Figure 3-1 Wire Routing Example

3.5 Board Assembly Diagram

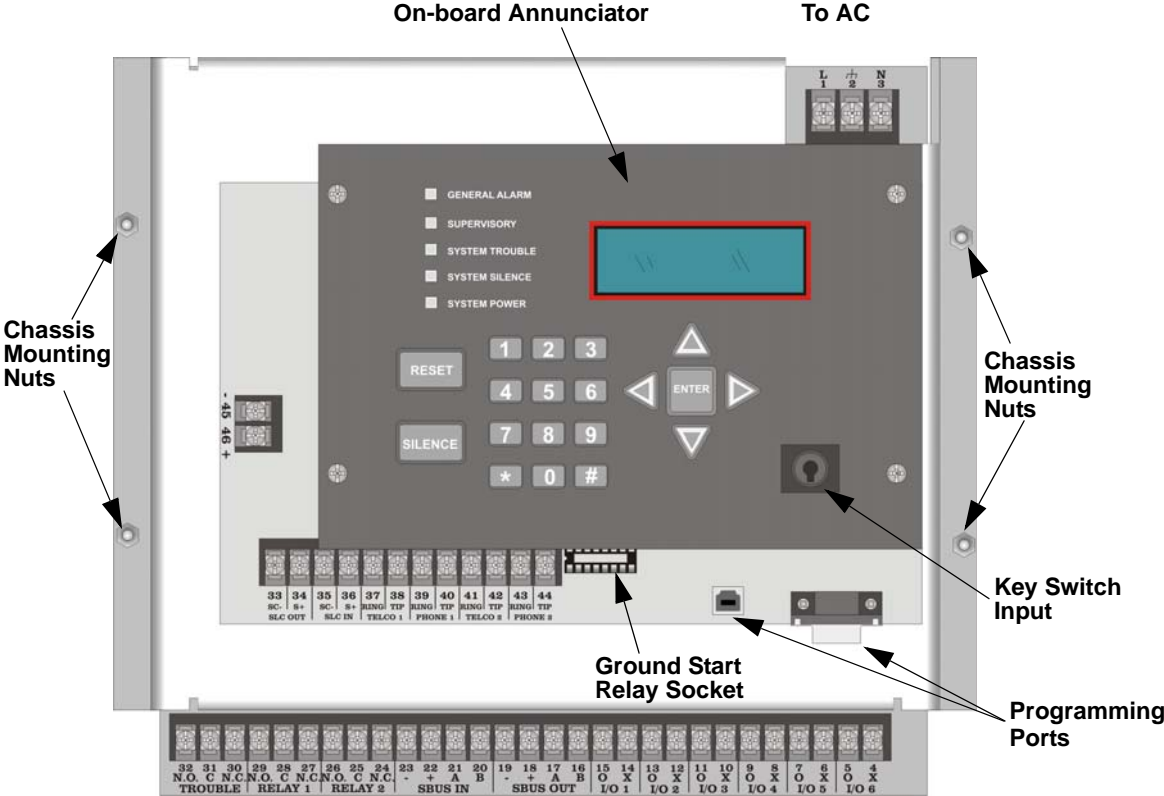

Figure 3-2 Model 5820XL Assembly

Figure 3-2 shows the circuit boards, metal housing and annunciator that attach the 5820XL assembly to the cabinet. If you should need to remove the board assembly for repair, remove the four mounting nuts which hold the assembly in the cabinet. Then lift the entire assembly out of the cabinet. Do not attempt to remove the circuit boards from the metal bracket.

3.6 Calculating Current Draw and Standby Battery

This section is for helping you determine the current draw and standby battery needs for your installation.

3.6.1 Current Draw Worksheet Requirements

The following steps must be taken when determining 5820XL current draw and standby battery requirements.

1. You will use the Current Draw Worksheet to determine current draw and standby battery requirements. Use Table 3-1 if installing SK SLC Devices and Table 3-2 if installing Hochiki SLC Devices. For the 5820XL, the worst case current draw is listed for the panel, addressable devices, and all SBUS expanders. Fill in the number of addressable devices and expanders that will be used in the system and compute the current draw requirements for alarm and standby. Record this information in the Current Draw Worksheet on Line A.
2. Add up the current draw for all auxiliary devices and record in the table at Line B.
3. Add up all notification appliance loads and record in the table at Line C.
4. For notification appliances and auxiliary devices not mentioned in the manual, refer to the device manual for the current ratings.
5. Make sure that the total alarm current you calculated, including current for the panel itself, does not exceed 6.0 A. This is the maximum alarm current for the 5820XL control panel.

If the current is above 6.0 A you will need to use a notification power expander(s) such as the Silent Knight 5495 or the 5895XL intelligent power expander, to distribute the power loads so that the 5820XL or the power expanders do not exceed their power rating. Refer to the current draw worksheets provided with the 5495 or the 5895XL manuals so you do not exceed their power requirements.

6. Complete the remaining instructions in the appropriate Current Draw Worksheet for determining battery size requirements.

3.6.2 Current Draw Worksheet for SK SLC Devices

Use Table 3-1 to determine current requirements during alarm/battery standby operation when SK SLC devices are installed. You can install up to 99 SK detectors per loop (396 max per panel) and 99 SK modules per loop (396 max per panel). Copy this section if additional space is required.

Table 3-1: Current Draw Worksheet for SK SLC Devices

Device	# of Devices	Current per Device		Standby Current	Alarm Current	
For each device use this formula: This column X This column = Current per number of devices.						
Fire Panel (Current draw from battery)	1	Standby:	215 mA	215 mA		
		Alarm:	385 mA		385 mA	
Addressable SLC Detectors						
SK-Photo	(99 max/loop & 396 max/panel) ¹	Standby/Alarm: 0.27 mA		mA	mA	
SK-Photo-T				mA	mA	
SK-Ion				mA	mA	
SK-Heat				mA	mA	
SK-Heat-HT				mA	mA	
SK-Beam (without integral test)		SLC	Standby/Alarm:	2 mA		
		Aux. Pwr	Standby:	2 mA	mA	
SK-Beam-T ⁵ (with integral test)		Aux. Pwr	Alarm:	8.5 mA		mA
		SLC	Standby/Alarm:	2 mA		
SK-Duct ⁶		Aux. Pwr	Standby:	2 mA	mA	
		Aux. Pwr	Alarm:	8.5 mA		mA
SK-Acclimate		SLC	Standby/Alarm:	0.27 mA	mA	mA
SK-Heat-ROR		Standby/Alarm:		0.3 mA	mA	mA

Device	# of Devices	Current per Device	Standby Current	Alarm Current	
Addressable SLC Modules					
SK-Control	(99 max/loop & 396 max/ panel) ¹	SLC	Standby/ 0.375mA	mA	
			Alarm 0.375mA		mA
Aux Pwr		Standby/ 1.7mA	mA		
		Alarm: 7mA		mA	
SK-Monitor		Standby/Alarm: 0.375 mA		mA	mA
SK-Minimon				mA	mA
SK-Pull-SA				mA	mA
SK-Pull-DA					
SK-Monitor-2		Standby/Alarm: 0.75 mA		mA	mA
SK-Mon10		Standby/Alarm: 3.5 mA		mA	mA
SK-Relay-6	Standby/Alarm: 1.45 mA		mA	mA	
SK-Control-6	SLC	Standby/ 2.25 mA	mA		
		Alarm: 2.25 mA			
SK-Relay	Aux Pwr	Standby/ 1.7 mA	mA		
		Alarm: 20 mA		mA	
SK-Zone	Standby/Alarm: 0.255 mA		mA	mA	
SK-Zone-6	Aux Pwr	Standby 12 mA	mA		
		Alarm 90 mA		mA	
SK-Zone-6	SLC	Standby/ Alarm 0.27mA		mA	
		Standby 50 mA	mA		
SK-Zone-6	Aux Pwr	Alarm 270 mA		mA	
		SLC	Standby/Alarm 2 mA	mA	mA
SLC Accessories					
B501BHT-2 Sounder Base	(99 max/loop & 396 max/ panel)	Aux Pwr	Standby: 1 mA	mA	
			Alarm: 15 mA		mA
SLC		Alarm: 0.7 mA		mA	
B224RB Relay Base		Standby/Alarm: 0.5 mA		mA	
RTS151/151 KEY		Alarm: 7.5 mA		mA	
RA100Z	Alarm: 10 mA		mA		
SLC Isolator Devices					
SK-Iso (Isolator Module)	(100 max/loop & 400 max/ panel)	Standby/Alarm: 0.45 mA		mA	
B224BI Isolator Base		Standby/Alarm: 0.5 mA		mA	
Accessories Modules					
5815XL SLC Expander	(3 max.)	Standby/Alarm: 55 mA		mA	
5860 Remote Fire Alarm Annunciator	(8 max.)	Standby: 20 mA		mA	
		Alarm: 25 mA		mA	
5824 Serial/Parallel Printer Interface Module	(2 max.)	Standby/Alarm: 45 mA		mA	
5496 Intelligent Power Module	(8 max.)	Standby/Alarm: 10 mA			
5895XL IntelliKnight Power Module		Standby/Alarm: 10 mA		mA	

	Device	# of Devices	Current per Device	Standby Current	Alarm Current		
A	5865-4 LED Annunciator (with reset and silence switches)	(8 max.)	Standby:	35 mA	mA		
			Alarm:	145 mA		mA	
	5865-3 LED Annunciator		Standby:	35 mA	mA		
			Alarm:	145 mA		mA	
	5880 I/O Module		Standby:	35 mA	mA		
			Alarm:	200 mA		mA	
	5883 Relay Interface		Standby:	0 mA	mA		
			Alarm:	220 mA (22 mA per relay)		mA	
	Total System Current						
	Auxiliary Devices ³		Refer to devices manual for current rating.				
		Alarm/Standby:	mA	mA	mA		
		Alarm/Standby:	mA	mA	mA		
		Alarm/Standby:	mA	mA	mA		
		Alarm/Standby:	mA	mA	mA		
B	Auxiliary Devices Current						
	Notification Appliance Circuits		Refer to device manual for current rating.				
			Alarm:	mA		mA	
			Alarm:	mA		mA	
			Alarm:	mA		mA	
C	Notification Appliances Current				mA		
	Total current ratings of all devices in system (line A + line B + C)			mA	mA		
D	Total current ratings converted to amperes (line D x .001):			A	A		
E	Number of standby hours (24 or 60 for NFPA 72, chapter 1, 1-5.2.5):			H			
F	Multiply lines E and F.		Total standby AH	AH			
G	Alarm sounding period in hours. (For example, 5 minutes = .0833 hours)				H		
H	Multiply lines E and H.		Total alarm AH		AH		
I	Add lines G and I. ⁴		Total ampere hours required	AH			
J							

- Total does not include isolator devices or accessory bases.
- If using door holders, you do not need to consider door holder current for alarm/battery standby, because power is removed during that time. However, during normal operation, door holders draw current and must be included in the 6.0A total current that can be drawn from the panel.
- Use next size battery with capacity greater than required.
- SK-Beam-T draws a maximum of 500mA from Auxiliary power only when the test feature is used. this should be considered when determining auxiliary power capacity but not calculated into current requirements for day to day operation.
- The SK-Duct housing contains a vacant mount for a SK-Relay (sold separately). Current draw for the SK-Relay is calculated by increasing the SK-Relay row of the calculation sheet by one for each SK-Relay used with a SK-Duct.

3.6.3 Current Draw Worksheet for Hochiki SLC Devices

Use Table 3-2 to determine current requirements during alarm/battery standby operation when Hochiki SLC devices are installed. You can install up to 127 Hochiki devices per loop (508 max per panel). Copy this section if additional space is required.

Table 3-2: Current Draw Worksheet for Hochiki SLC Devices

Device	# of Devices	Current per Device		Standby Current	Alarm Current
For each device use this formula: This column X This column = Current per number of devices.					
IntelliKnight 5820XL Fire Panel (Current draw from battery)	1	Standby:	215 mA	215 mA	
		Alarm:	385 mA		385 mA
Addressable SLC Devices					
SD500-AIM	(508 max.) ¹	Standby/Alarm:	0.55 mA		mA
SD500-MIM					mA
SD500-PS					
SD500-ARM					mA
SD505-AHS					mA
SD505-AIS					mA
SD505-APS					mA
SD500-ANM	(508 max.) ¹	Aux. Pwr	Standby: 8 mA		mA
			Alarm: 60 mA		mA
SD500-SDM	(508 max.) ¹	SLC	Standby/Alarm: .55 mA		mA
		Aux. Pwr	Standby: 20 mA		mA
			Alarm: 106 mA		mA
SD500-LED	(100 max.) ¹	Aux. Pwr	Standby: 10 mA		mA
			Alarm: 220 mA		mA
			LED: 10 mA		mA
		SLC	Standby/Alarm: 0.55 mA		mA
SLC Accessory Bases					
SD505-6RB	(508 max.)	Standby/Alarm:	.082 mA		mA
SD505-6SB	(508 max.)	Aux. Pwr	Standby: 1 mA		mA
			Alarm: 32 mA		mA
		SLC	Standby/Alarm: .082 mA		mA
SD505-ADHR SD505-DUCTR	(508 max.)	Aux. Pwr	Standby: 35 mA ²		mA
			Alarm: 75 mA ²		mA
		SLC	Standby/Alarm: .082 mA		mA
SD505-DTS SD505-DTS-K	(508 max.)		None, included with SD505-ADHR worst case.		
SD505-ADH SD505-DUCT	(508 max.)		None, included with detector current.		
SLC Isolator Devices					
SD500-LIM	(1024 max.)	Standby/Alarm	0.092 mA	mA	mA
SD505-6IB	(508 max.)				
Accessories Modules					
5815XL SLC Expander	(3 max.)	Standby/Alarm:	55 mA		mA
5860 Remote Fire Alarm Annun.	(8 max.)	Standby:	20 mA		mA
		Alarm:	25 mA		mA

	Device	# of Devices	Current per Device	Standby Current	Alarm Current
	5824 Serial/Parallel Printer Interface	(2 max.)	Standby/Alarm: 45 mA	mA	mA
	5895XL IntelliKnight Power Expander	(8 max.)	Standby/Alarm: 10 mA	mA	mA
	5496 Intelligent Power Module		Standby/Alarm: 10 mA	mA	mA
	5865-4 LED Annunciator (with reset and silence switches)	(8 max.)	Standby: 35 mA	mA	
			Alarm: 145 mA		mA
	5865-3 LED Annunciator		Standby: 35 mA	mA	
			Alarm: 145 mA		mA
	5880 LED I/O Module		Standby: 35 mA	mA	
			Alarm: 200 mA		mA
	5883 Relay Interface	(32 max.)	Standby: 0 mA	mA	
			Alarm: 220 mA (22 mA per relay)		mA
A	Total System Current				
	Auxiliary Devices ³	Refer to devices manual for current rating.			
			Alarm/Standby: mA	mA	mA
			Alarm/Standby: mA	mA	mA
			Alarm/Standby: mA	mA	mA
			Alarm/Standby: mA	mA	mA
B	Auxiliary Devices Current				
			Alarm: mA		mA
			Alarm: mA		mA
			Alarm: mA		mA
			Alarm: mA		mA
C	Notification Appliances Current				mA
D	Total current ratings of all devices in system (line A + line B + C)			mA	mA
E	Total current ratings converted to amperes (line D x .001):			A	A
F	Number of standby hours (24 or 60 for NFPA 72, chapter 1, 1-5.2.5):			H	
G	Multiply lines E and F. Total standby AH			AH	
H	Alarm sounding period in hours. (For example, 5 minutes = .0833 hours)				H
I	Multiply lines E and H. Total alarm AH				AH
J	Add lines G and I. ⁴ Total ampere hours required			AH	

1. Total does not include isolator devices or accessory bases.
2. If using 24 VDC aux power only. No standby or alarm current for battery calculation if using 24 VAC, 120 VAC or 240 VAC.
3. If using door holders, you do not need to consider door holder current for alarm/battery standby, because power is removed during that time. However, during normal operation, door holders draw current and must be included in the 6.0A total current that can be drawn from the panel.
4. Use next size battery with capacity greater than required.

3.6.4 Maximum Battery Standby Load

Table 3-3 shows the maximum battery standby load for the 5820XL based on 24 and 60 hours of standby. The standby load calculations of line D in the Current Draw Calculation Worksheet (Table 3-1 for SK devices and Table 3-2 for Hochiki devices) must be less than the number shown in Table 3-3 for the battery size used and standby hours required

* 33AH max battery size for FM (Factory Mutual) installations..

Table 3-3: Maximum Battery Standby Load

Rechargeable Battery Size	Max. Load for 24 hrs. Standby, 5 mins. Alarm	*Max. Load for 60 hrs. Standby, 5 mins. Alarm
7 AH	270 mA	105 mA
12 AH	475 mA	190 mA
18 AH	685 mA	270 mA
35 AH	1.3 A	540 mA

* Required for NFPA 72 Auxiliary Protected Fire Alarm systems for Fire Alarm Service (City Box) and Remote Station Protected Fire Alarm systems (Polarity Reversal) and Digital Alarm Communicator/Transmitter (DACT).

Warning!

Silent Knight does not support the use of batteries smaller than those listed in Table 3-3. If you use a battery too small for the installation, the system could overload the battery resulting in the installation having less than the required 24 hours standby power. Use Table 3-3 to calculate the correct battery amperes/hour rating needed for your installation.

3.7 Installation Tasks Overview

This section provides a chart listing tasks that need to be performed when installing the IntelliKnight 5820XL system. The chart is intended to be a handy way for you to make sure you have completed all necessary tasks. Unless noted, these tasks do not have to be performed in the order they are listed here.

Important: Connect and address SLC devices before running JumpStart.

Task	See Sec. (for more info.)
Main Panel Hardware Installation	
<input type="checkbox"/> Mount the control panel cabinet.	4.1
<input type="checkbox"/> Connect AC.	4.2
<input type="checkbox"/> Connect phone lines.	4.11
<input type="checkbox"/> Install 5815XL SLC expander modules (if needed). Required if more than 127 SLC devices are used.	4.6
<input type="checkbox"/> Install 5860 Remote Fire Alarm Annunciator modules if used.	4.5
<input type="checkbox"/> Install 5865 or LED Annunciator modules if used.	4.9
<input type="checkbox"/> Install 5880 LED I/O module if customized LED annunciation will be used.	4.8
<input type="checkbox"/> Install notification appliances.	4.13
<input type="checkbox"/> Install auxiliary power devices (if used).	4.13.5
<input type="checkbox"/> If using a printer, install the 5824 Serial/Parallel Printer Interface Module.	4.7
<input type="checkbox"/> Connect batteries (typically last step).	4.3

Task	See Sec. (for more info.)
SLC Device Hardware Installation Perform these steps before running JumpStart.	
<input type="checkbox"/> Connect device bases to the loop.	SK 5.5 Hochiki 5.3
<input type="checkbox"/> Set device addresses.	SK 5.6 Hochiki 5.8
<input type="checkbox"/> Physically connect detectors to their bases. Connect relay and contact monitor modules.	5.4 & see device install instructions
JumpStart	
JumpStart is for initial system programming. JumpStart automatically selects some options for SLC devices. See "Input Point Configuration" section of this chart for other options. JumpStart makes selections for the following options. You can customize options, if necessary.	6.1 & 7.8
Device type (detector or switch) configured by JumpStart.	To change, see 7.6
Program type of detector (heat, photoelectric, or ionization) selected by JumpStart.	To change, see 7.6
System Software Configuration	
<input type="checkbox"/> Select low AC hours report time (6 hours by default).	7.7.4.2
<input type="checkbox"/> Select Auto Test Time (2:00 AM by default).	7.7.1.2
<input type="checkbox"/> Enable/disable automatic DST adjustment feature (enabled by default).	7.7.4.3
<input type="checkbox"/> Change clock display format (12-hour with AM/PM by default).	7.7.4.4
<input type="checkbox"/> Set up reporting accounts.	7.7.1
<input type="checkbox"/> Select options for phone lines.	7.7.2
<input type="checkbox"/> Select system-wide response to trouble conditions, if desired.	7.7.3
<input type="checkbox"/> Select system-wide cadence patterns for special conditions (fire drill, Aux1 and Aux2 alarms) if desired.	7.7.3
<input type="checkbox"/> Customize banner message (message that displays on LCD in normal mode) if desired.	7.7.7
Input Point (SLC Device) Configuration	
JumpStart automatically selects some options for SLC devices (see "JumpStart" section of this chart). You can change options selected by JumpStart, if necessary and further customize input point options.	
<input type="checkbox"/> Select device type (SK or Hochiki). Only one device type can be used per control panel.	7.2
<input type="checkbox"/> Program type of switch (manual pull, fire drill, and so on), if necessary. (JumpStart assigns all switches as Manual Pull type.)	7.6
<input type="checkbox"/> If the installation includes duct detectors, program detector type. (JumpStart does not distinguish duct detectors from ordinary smoke detectors.)	7.6
<input type="checkbox"/> Assign a name (or description) to the point.	7.6.3.1
<input type="checkbox"/> Assign input points to zones, if necessary. (JumpStart assigns all input points to Zone 1.)	7.6
Zone Configuration	
<input type="checkbox"/> Add the zone to the system if it does not already exist. (Zone 1 created by JumpStart.)	7.4.2
<input type="checkbox"/> Program a name (or description) for the zone.	7.4.1.1

Task	See Sec. (for more info.)
<input type="checkbox"/> Select alarm delay options (detection characteristics) for zone.	7.4.1.2
<input type="checkbox"/> Select heat detector trip temperature. (JumpStart selects 150°F for heat detectors.)	7.4.1.2
Output Point Configuration	
Conventional notification circuits (circuits 1-6):	
<input type="checkbox"/> Enable circuits used for notification appliances through programming, if necessary. (JumpStart enables circuits 1-6 as Notification.)	7.5.1
Conventional relay circuits (circuits 7-8):	
<input type="checkbox"/> Select options for relay circuits, if desired. Note: Relay circuits will always output continuously (constant pattern), even if assigned to an Output Group that uses a different output pattern.	7.5.1
Auxiliary power circuits (circuits 1-6):	
<input type="checkbox"/> Enable any circuit used for auxiliary power devices through programming.	7.6
<input type="checkbox"/> Select type of power (door holder, constant, or resettable)	7.6
Addressable relay modules	
<input type="checkbox"/> Assign addressable relay modules to output groups through programming. (JumpStart assigns all relay modules to Group 1.)	7.6
LED output points (from the 5880 LED I/O module or 5865/66 LED Annunciator)	
<input type="checkbox"/> Assign LED modules to output groups through programming.	7.6.3
All output circuits (1-8):	
<input type="checkbox"/> Disable (set to UNUSED) any unused circuits. If you do not disable unused output circuits, they will cause a trouble condition (unless an EOL resistor is used).	7.6
<input type="checkbox"/> Select a name for the point, if desired.	7.6
Output Group Configuration	
<input type="checkbox"/> Add the group to the system if it does not already exist.	7.5.2
<input type="checkbox"/> Assign output points to the group.	7.6
<input type="checkbox"/> Program a name (or description) for the group, if desired.	7.5.1.1
Select “group properties” (see below).	
<input type="checkbox"/> Latching / non-latching	7.5.1
<input type="checkbox"/> Silencing option	7.5.1
<input type="checkbox"/> Select options for activation with system switches.	7.5.1
<input type="checkbox"/> Map zones to output groups that will activate when zone goes into alarm.	7.4.1.3
<input type="checkbox"/> Select a cadence pattern for outputs in the zone.	7.4.1.3

Section 4

Control Panel Installation

Caution!

To avoid the risk of electrical shock and damage to the unit, power should be OFF at the control panel while installing or servicing.

4.1 Mounting the Control Panel Cabinet

Read the environmental specifications in Section 3.2 before mounting the control panel cabinet. This will ensure that you select a suitable location.

The panel should be accessible to main drop wiring runs. It should be mounted as close to the center of the building as possible and located within a secured area, but should be accessible for testing and service.

Mount the control panel cabinet so it is firmly secured to the wall surface. When mounting on concrete, especially when moisture is expected, attach a piece of 3/4-inch plywood to the concrete surface and then attach the cabinet to the plywood. Also mount any other modules to the plywood.

The cabinet can be surface- or flush-mounted. If you will be flush-mounting the cabinet, the hole for the enclosure should be 14.75" W x 25" H x 4" D. Do NOT flush-mount in a wall designated as a fire break.

4.1.1 Preventing Water Damage

Water damage to the fire system can be caused by moisture entering the cabinet through the conduits. Conduits that are installed to enter the top of the cabinet are most likely to cause water problems. Installers should take reasonable precautions to prevent water from entering the cabinet. Water damage is not covered under warranty.

4.1.2 Removing the 5820XL Assembly from the Housing

If it should ever be necessary to remove the control panel assembly from the cabinet for repair, do so by unscrewing the nuts that connect the control panel assembly to the cabinet. Do not attempt to disassemble the circuit boards. See Section 3.5 for location of the nuts.

4.2 AC Connection

At installation, connect the AC terminals to the power source as shown in Figure 4-1. It may be necessary for a professional electrician to make this connection.

The AC terminals are rated at 120 VAC, 50 or 60 Hz, 2.5A.

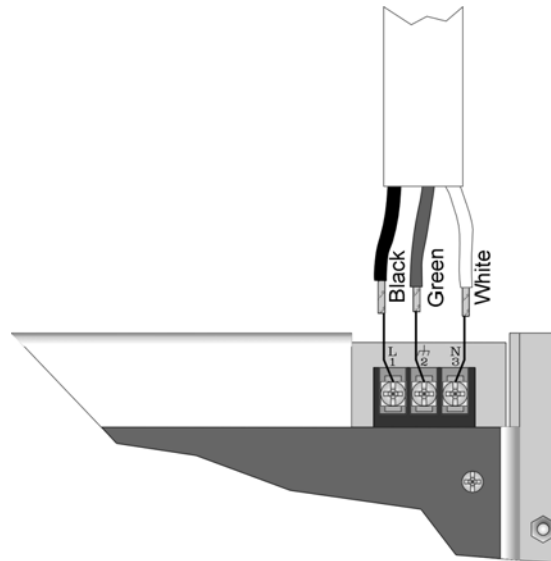

Figure 4-1 120 VAC Power Connection

4.3 Battery Connection

The control panel battery charge capacity is 7.0 to 35 AH. Use 12V batteries of the same AH rating. Determine the correct AH rating as per your current load calculation (see Section 3.6).

Wire batteries in series to produce a 24-volt equivalent. Do not parallel batteries to increase the AH rating. It is recommended that you replace batteries every five years.

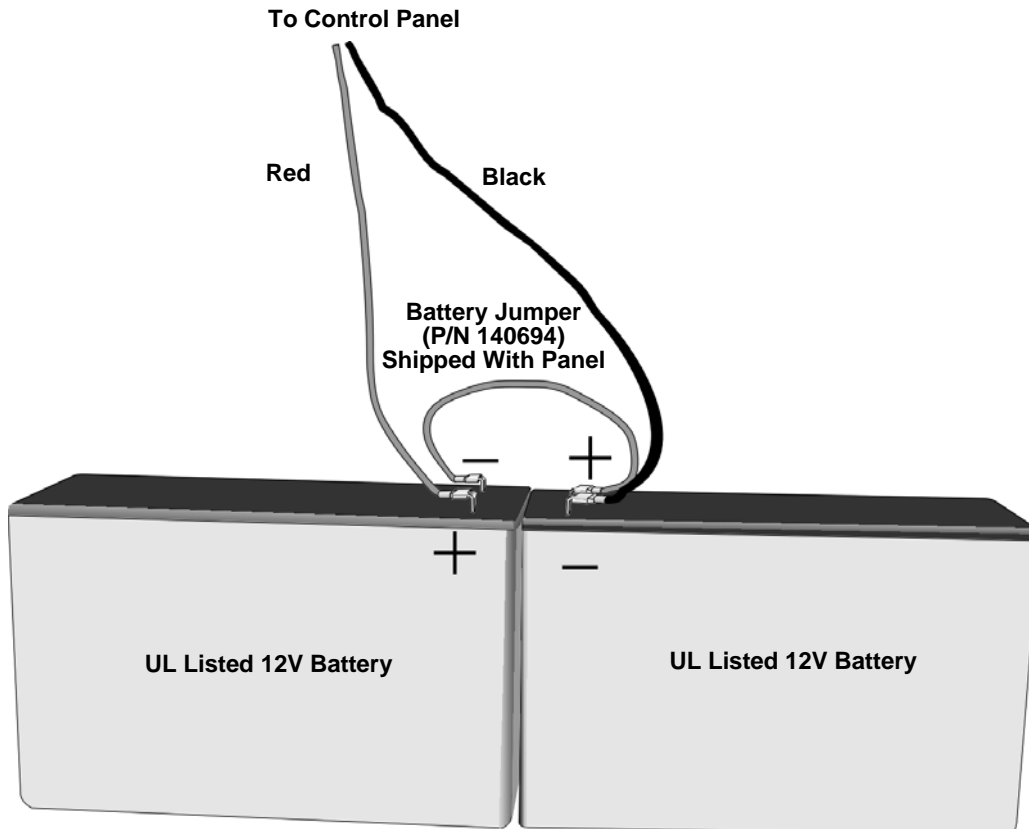

Figure 4-2 Battery Connection

4.3.1 RBB Accessory Cabinet

The Model RBB Accessory cabinet can be used when your backup batteries requirements use backup batteries that are too large to fit into the main control panel cabinet. The RBB cabinet holds batteries up to the 35 AH size. The RBB dimensions are 16" W x 10" H x 6" D (40.64 cm W x 25.4 cm H x 15.24 cm D).

4.3.1.1 Installing the RBB Accessory Cabinet and Batteries

To properly install the accessory cabinet and backup batteries, follow these steps:

1. Mount the accessory cabinet. See figure Figure 4-3 for the four cabinet mounting holes.
 - If mounting onto drywall the accessory cabinet must be mounted onto 3/4-inch plywood. This is necessary because the weight of the batteries inside the accessory cabinet could cause the cabinet to pull away from the drywall.
 - When mounting on concrete, especially when moisture is expected, attach a piece of 3/4-inch plywood to the concrete surface and then attach the RBB cabinet to the plywood.
 - If using the battery cable extenders provided (P/N 140643), mount the RBB cabinet no more than 18" away from the main control panel cabinet. This will ensure that the battery cables reach the battery terminals.

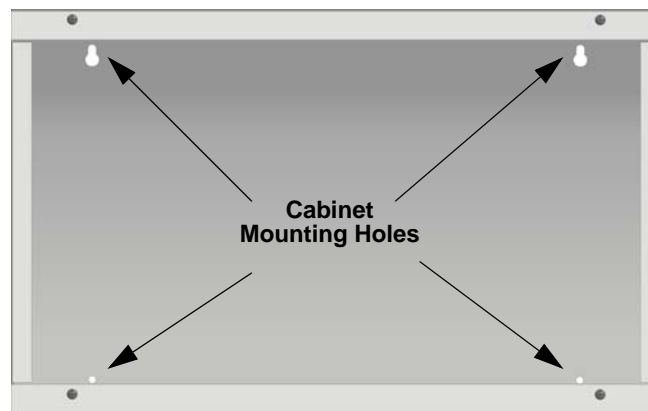

Figure 4-3 RBB Cabinet Mounting Holes

2. Connect the main control panel battery cables to the battery cable extenders as shown in Figure 4-4.

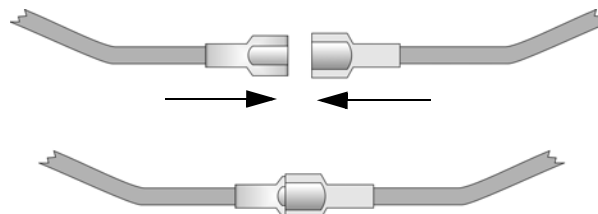

Figure 4-4 Splicing Control panel Battery Cable to RBB Battery Cable Extenders

- Run extended battery cable from control panel cabinet through conduit to RBB cabinet. See Figure 4-5.

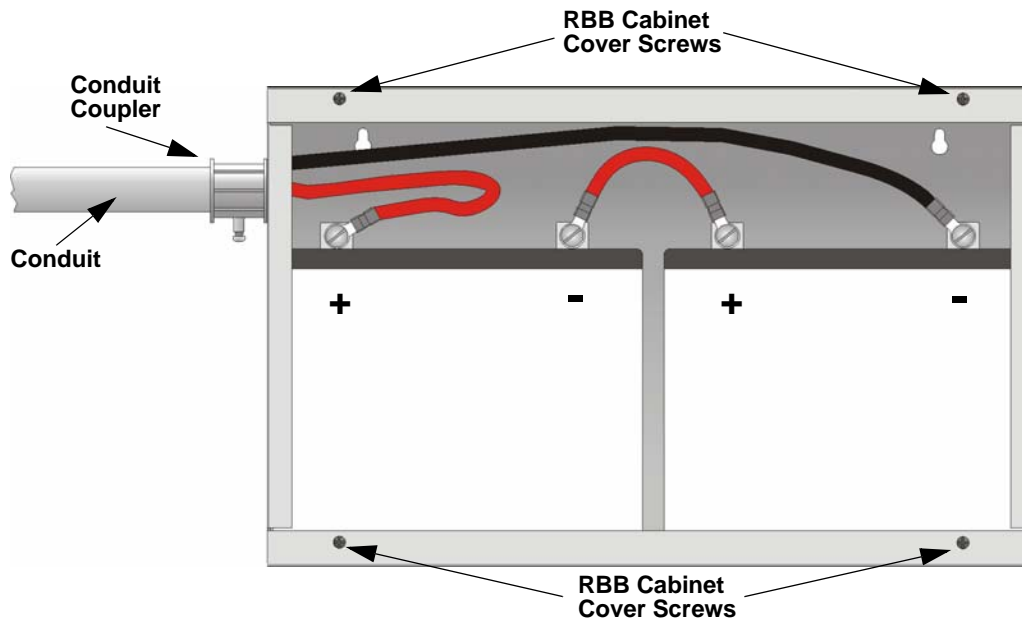

Figure 4-5 Battery Connections in the RBB Cabinet

Note: Figure 4-5 is an example of how the wire connections can be routed. However, any other cabinet knock-outs (on either the main control panel or the RBB cabinet), that are not previously being used may be utilized to connect conduit between the two cabinets.

- Connect battery leads to the backup battery terminals. See Figure 4-5.
Observe the proper polarity to prevent damage to the batteries or the control panel.
- Insert the RBB cover screws into the cover mounting holes (see Figure 4-5).
Screw the cover screw 3/4 of the way into the cover mounting hole.
- Align the cover plate mounting keyhole over the cover mounting screws. See Figure 4-6.

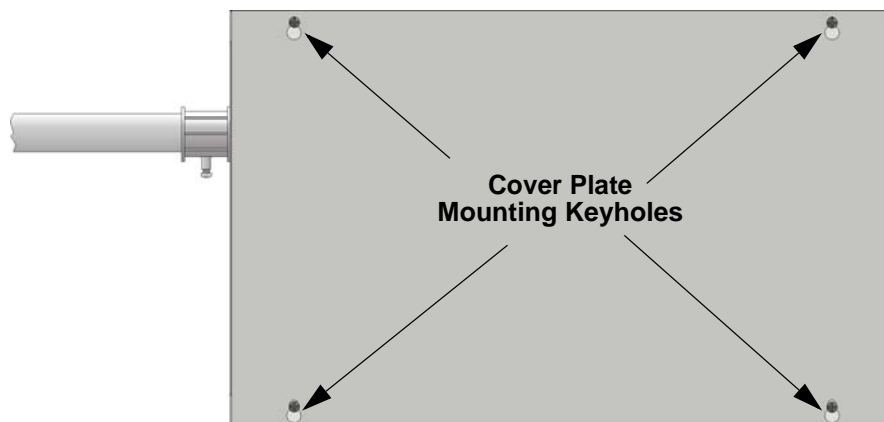

Figure 4-6 Cover Plate Mounting Keyholes and Cover Mounting Screws Alignment

- Slide the cover into place and tighten the cover mounting screws. See Figure 4-6

4.4 SBUS Wiring

This section contains information on calculating SBUS wire distances and the types of wiring configurations (Class A and B).

4.4.1 Calculating Wiring distance for SBUS modules

The following instructions will guide you in determining the type of wire and the maximum wiring distance that can be used with control panel SBUS accessory modules.

To calculate the wire gauge that must be used to connect SBUS modules to the control panel, it is necessary to calculate the total worst case current draw for all modules on a single 4-conductor bus. The total worst case current draw is calculated by adding the individual worst case currents for each module. The individual worst case values are shown in the table below.

Note: Total worst case current draw on a single SBUS cannot exceed 1 amp. If a large number of accessory modules are required, and the worst case current draw will exceed the 1 amp limit, then the current draw must be distributed using 5895XL Power Expanders. Each 5895XL Power Expander provides an additional SBUS, with an additional 1 amp of SBUS current. Wiring distance calculations are done separately for each 5895XL, and separately for the control panel itself.

Model Number	Worst Case Current Draw
5860 Fire Annunciator	.100 amps
5824 Serial/Parallel Printer Interface Module	.040 amps
5880 LED I/O Module	.250 amps
5865 LED Fire Annunciator	.200 amps
5895XL Intelligent Power Supply	.010 amps
5496 Intelligent Power Supply	.010 amps

Note: Refer to Table 3-2 for maximum number of each type of device that can be used per system.

After calculating the total worst case current draw, Table 4-1 specifies the maximum distance the modules can be located from the panel on a single wire run. The table insures 6.0 volts of line drop maximum. In general, the wire length is limited by resistance, but for heavier wire gauges, capacitance is the limiting factor.

These cases are marked in the chart with an asterisk (*). Maximum length can never be more than 6,000 feet, regardless of gauge used. (The formula used to generate this chart is shown in the note below).

Table 4-1: Wire Distances Per Wire Gauge Using Copper Wire

Wiring Distance: SBUS Modules to Panel				
Total Worst Case Current Draw (amps)	22 Gauge	18 Gauge	16 Gauge	14 Gauge
0.100	1852 ft.	4688 ft.	* 6000 ft.	* 6000 ft.
0.200	926 ft.	2344 ft.	3731 ft.	5906 ft.
0.300	617 ft.	1563 ft.	2488 ft.	3937 ft.
0.400	463 ft.	1172 ft.	1866 ft.	2953 ft.
0.500	370 ft.	938 ft.	1493 ft.	2362 ft.
0.600	309 ft.	781 ft.	1244 ft.	1969 ft.
0.700	265 ft.	670 ft.	1066 ft.	1687 ft.
0.800	231 ft.	586 ft.	933 ft.	1476 ft.
0.900	206 ft.	521 ft.	829 ft.	1312 ft.
1.000 (Max)	185 ft.	469 ft.	746 ft.	1181 ft.

Note: The following formulas were used to generate the wire distance chart:

$$\text{Maximum Resistance (Ohms)} = \frac{6.0 \text{ Volts}}{\text{Total Worst Case Current Draw (amps)}}$$

$$\text{Maximum Wire Length (Feet)} = \frac{\text{Maximum Resistance (Ohms)}}{\text{Rpu}} \quad * 500$$

(6000 feet maximum)

where: Rpu = Ohms per 1000 feet for various wire gauges (see table below)

Table 4-2: Typical Wire Resistance Per 1000 ft. Using Copper Wire

Wire Gauge	Ohms per 1000 feet (Rpu)
22	16.2
18	6.4
16	4.02
14	2.54

Wiring Distance calculation example:

Suppose a system is configured with the following SBUS modules:

- 2 - Module 5860 Fire Annunciator
- 1 - 5895XL Intelligent Power Expander
- 1 - 5865 LED Fire Annunciator
- 1 - 5824 Serial/Parallel Interface Module

The total worst case current is calculated as follows:

5860 Current Draw	= 2 x .100 amps	= .200 amps
5895XL Current Draw	= 1 x .010 amps	= .010 amps
5865 Current Draw	= 1 x .200 amps	= .200 amps
5824 Current Draw	= 1 x .040 amps	= .040 amps
<hr/>		
Total Worst Case Current Draw		= .450 amps

Using this value, and referring to the Wiring Distance table, it can be found that the available options are:

- 370 feet maximum using 22 Gauge wire
- 938 feet maximum using 18 Gauge wire
- 1493 feet maximum using 16 Gauge wire
- 2362 feet maximum using 14 Gauge wire

4.4.2 Wiring Configurations

Figure 4-7 illustrates Class A wiring configuration and Figure 4-8 illustrates Class B configuration.

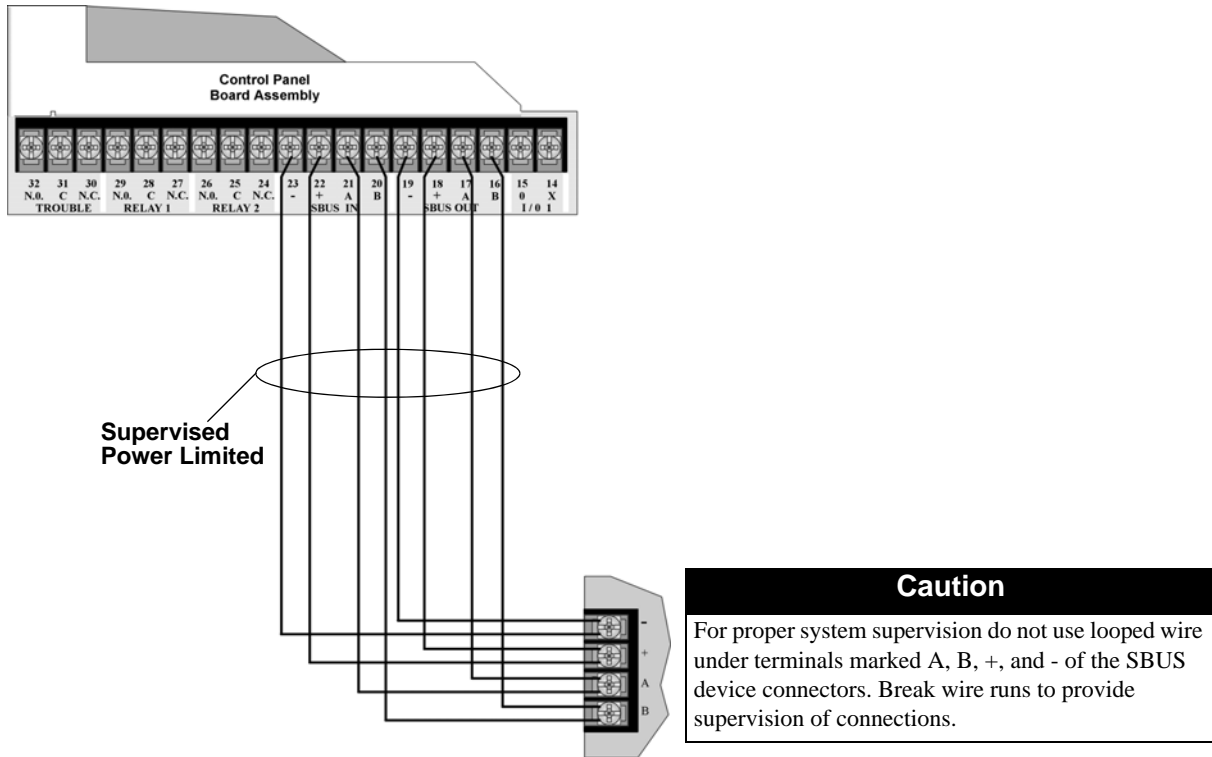

Figure 4-7 SBUS Class A Wiring

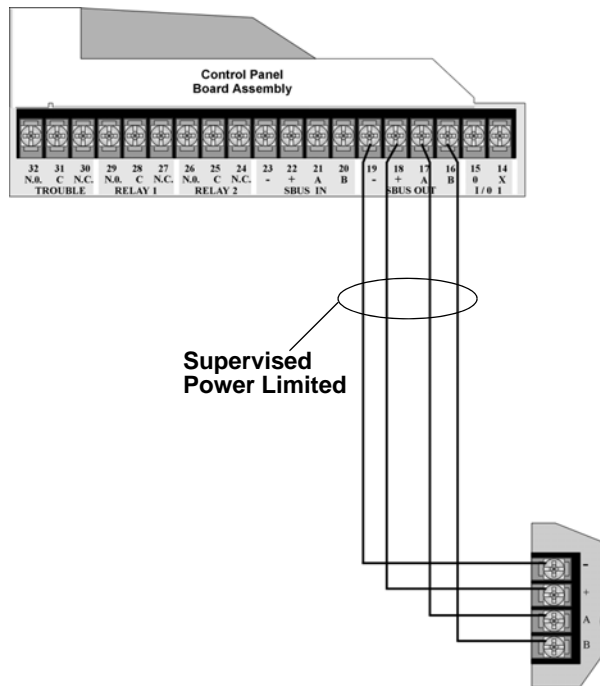

Figure 4-8 SBUS Class B Wiring

4.5 Remote Annunciator 5860 Installation

The optional Model 5860 Remote Annunciator, shown in Figure 4-9, performs the same functions as the on-board annunciator. Operation is identical. Up to 8 annunciators can be added to the IntelliKnight 5820XL system.

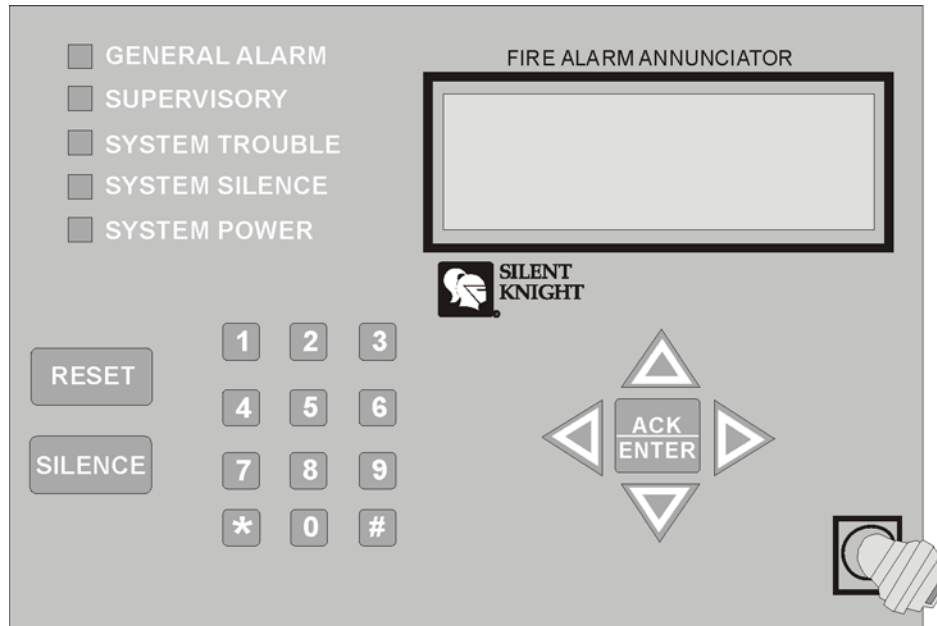

Figure 4-9 Model 5860 Remote Annunciator, Front View

5860 installation involves the following steps:

1. Make sure power is off at the panel.
2. Mount the 5860 in the desired location (see Section 4.5.1).
3. Connect the 5860 to the panel (see Section 4.5.2).
4. Use the on the back of the 5860 to assign an ID# to the 5860 (see Section 4.10.1).
5. The new 5860 module must be added to the system through programming. JumpStart will add the module automatically (see Section 6.1). You can also add it manually (see Section 7.3.2). Select a name, if desired (see Section 7.3.1.1).

4.5.1 Mounting the 5860

This section of the manual describes mounting the remote annunciator. The annunciator can be flush- or surface-mounted.

Figure 4-10 shows the parts of the annunciator. Instructions for disassembling and mounting appear on the following pages.

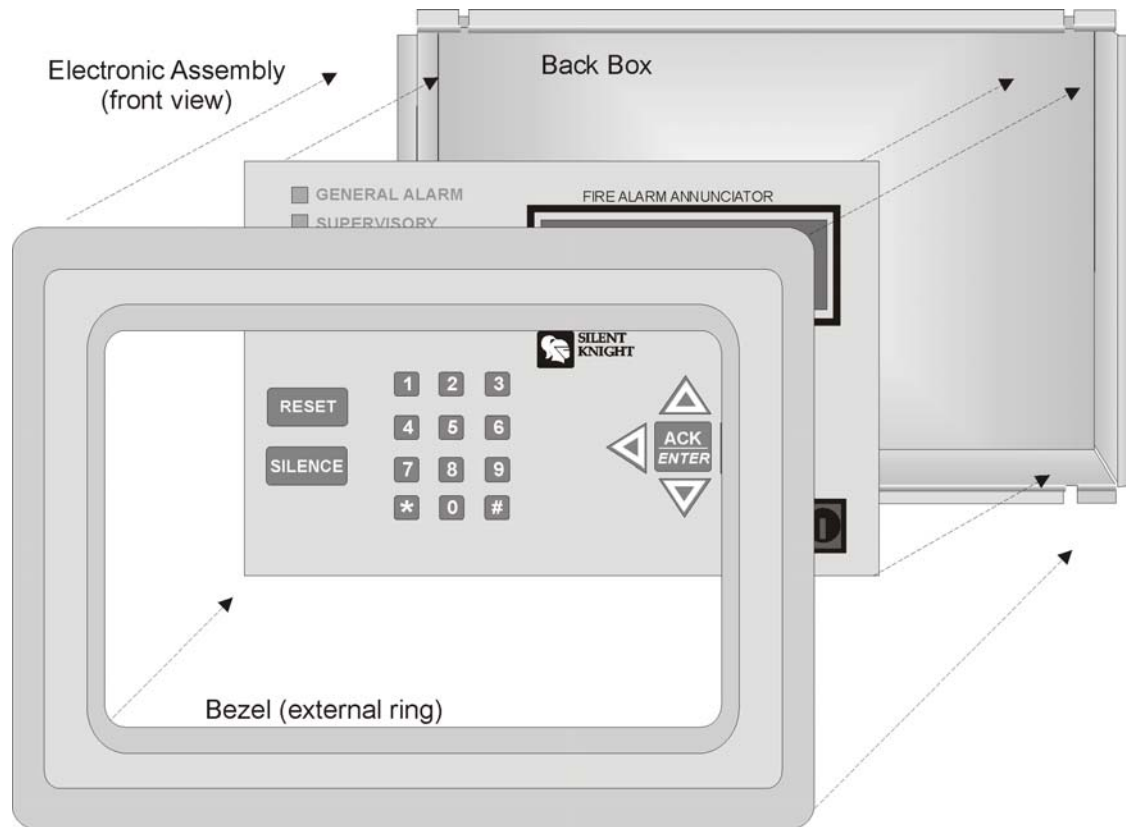

Assembled annunciator also includes mounting wires and 4 set screws.

Figure 4-10 Annunciator Parts

The 5860 comes from the factory fully assembled. You must disassemble it for mounting. To disassemble the annunciator, use a 5/64 hex wrench to remove the set screws, located on the bottom of the annunciator bezel. (See Figure 4-11 for location of the set screws.)

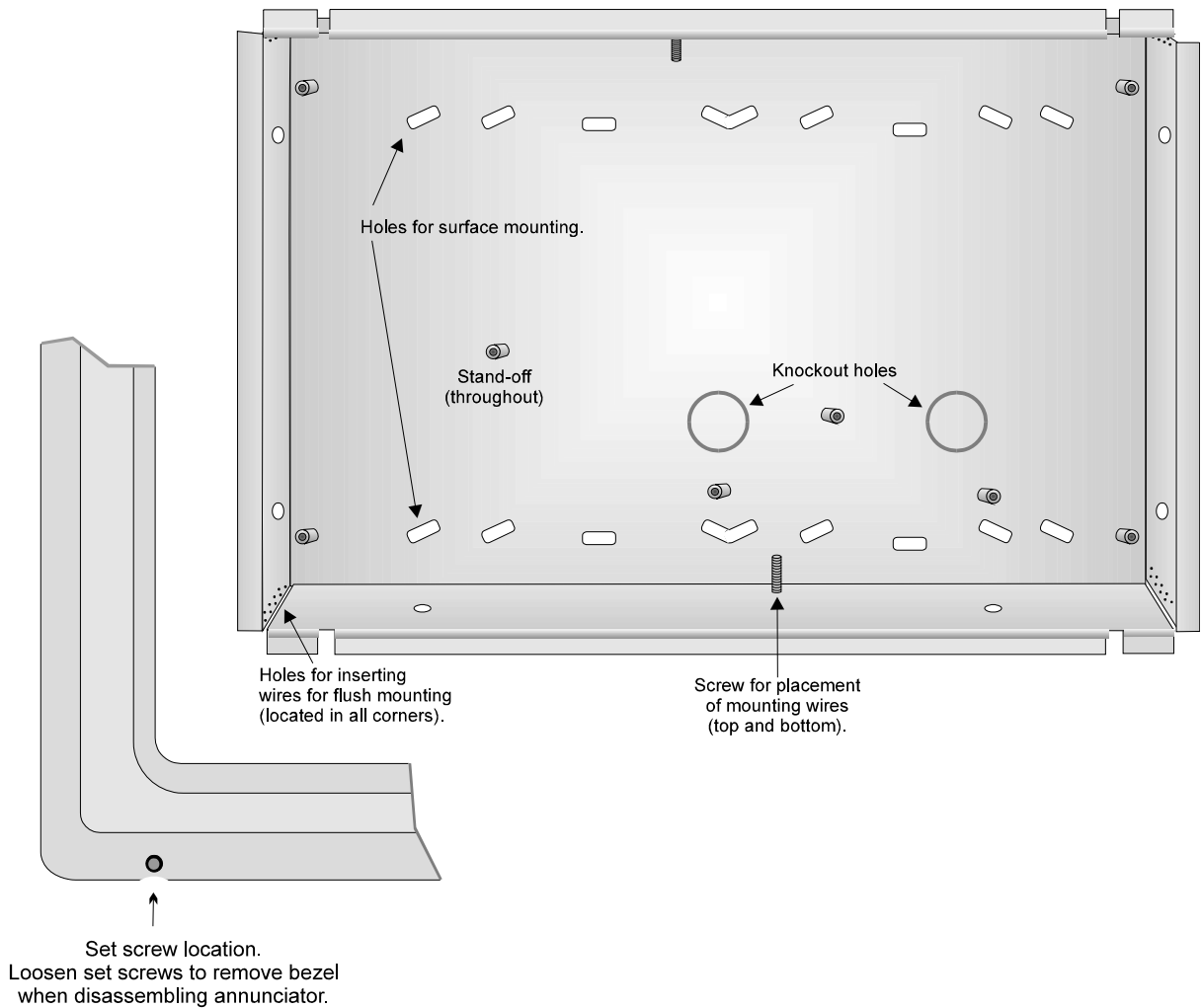

Figure 4-11 Annunciator Back Box and Bezel Details

4.5.1.1 Flush Mounting

This section of the manual describes flush mounting. You can flush-mount with or without an electrical box.

Flush Mounting with an Electrical Box

The 5860 annunciator can be used with the following types of electrical boxes: 4S, single-gang, and double-gang.

If an electrical box is used, the box must be 1-3/8" back from the face of the wall to accommodate the annunciator. Studs used with an electrical box must be two by fours (or larger).

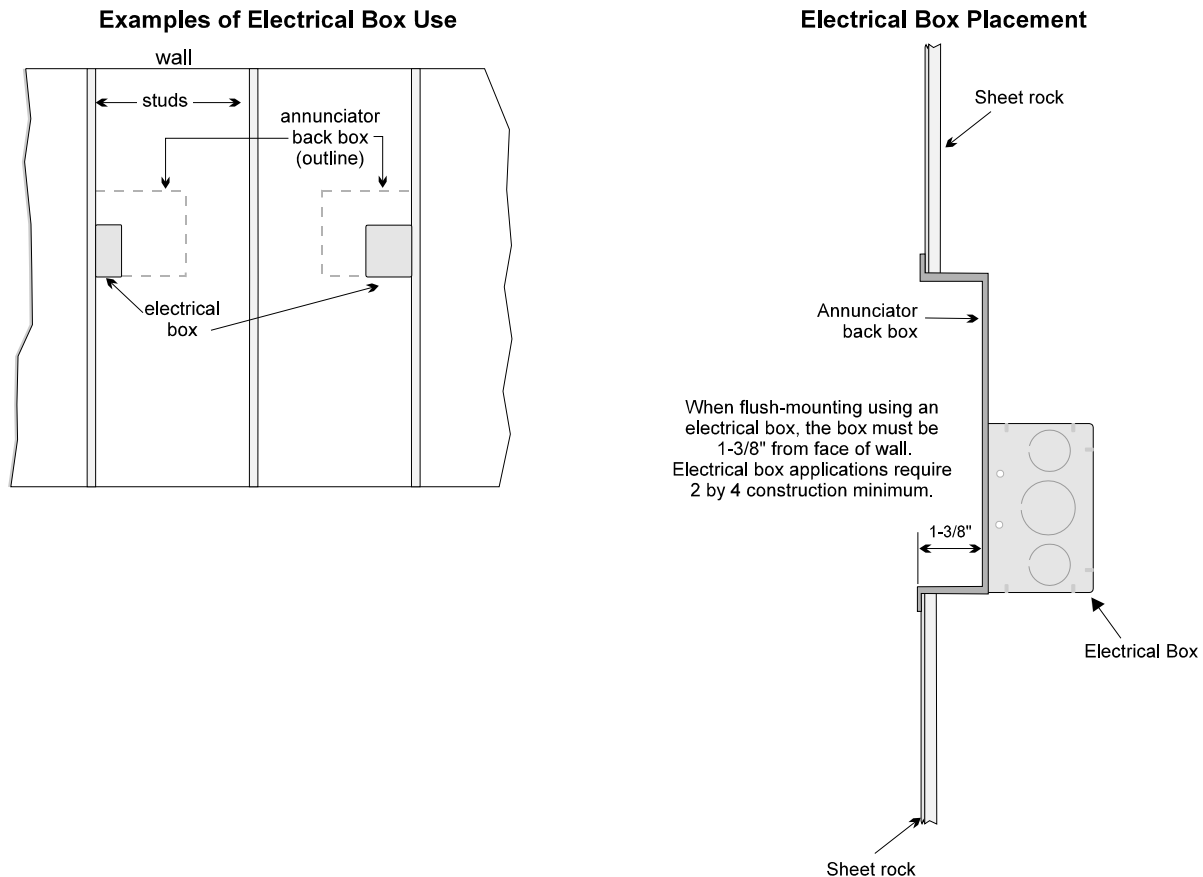

Figure 4-12 Placement of Electrical Box for Flush Mounting

Flush Mounting Steps

1. Cut a hole in the sheet rock to the following dimensions: 8-1/4" w x 6-5/8" h. If an electrical box is used, the box must be 1-3/8" back from face of wall to accommodate the annunciator (see Figure 4-12).
2. Remove knockout holes as needed for wires.
3. Fit the annunciator back box into the hole and stabilize with mounting wires. Angle the mounting wires into the first hole past the sheet rock. Secure the wires behind the screws as shown in Figure 4-13. When all four wires are in place, the back box should fit snugly into the hole in the sheet rock.

4. After the annunciator wiring to the panel has been completed (described in Section 4.5.2), replace the electronic assembly in the back box. Place the bezel over the back box and tighten the set screws on the bezel.

Attach second set of wires to top of back box.

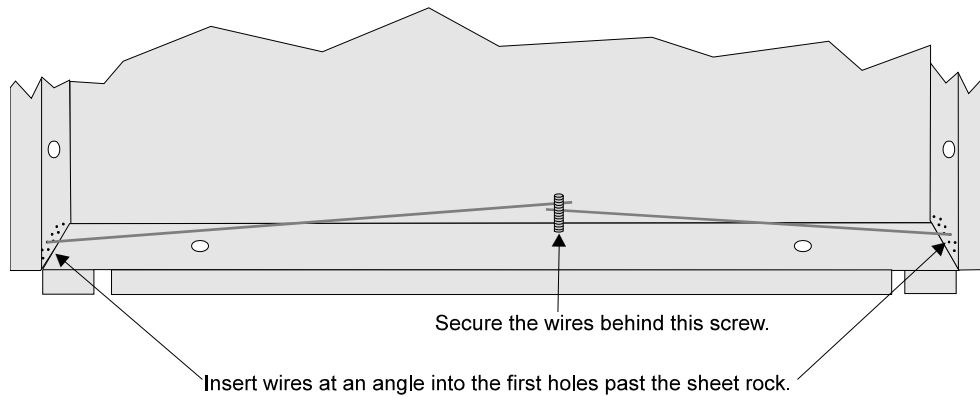

Figure 4-13 Flush Mounting the Back Box

4.5.1.2 Surface Mounting

The 5860 can be mounted directly to a surface or can be attached to a single, double, or four-square electrical box. The Model 5860TG/TR trim ring kit is available for use when surface mounting.

1. Drill holes in the surface to match the screw holes on the back box.
2. Fit the trim ring over the back box.
3. Attach the back box to the surface using screws provided.
4. After the annunciator wiring to the panel has been completed (described in Section 4.5.2), replace the electronic assembly in the back box. Place the bezel over the back box and tighten the set screws on the bezel.

4.5.2 Model 5860 Connection to the Panel

Connect the 5860 to the panel as shown in Figure 4-14.

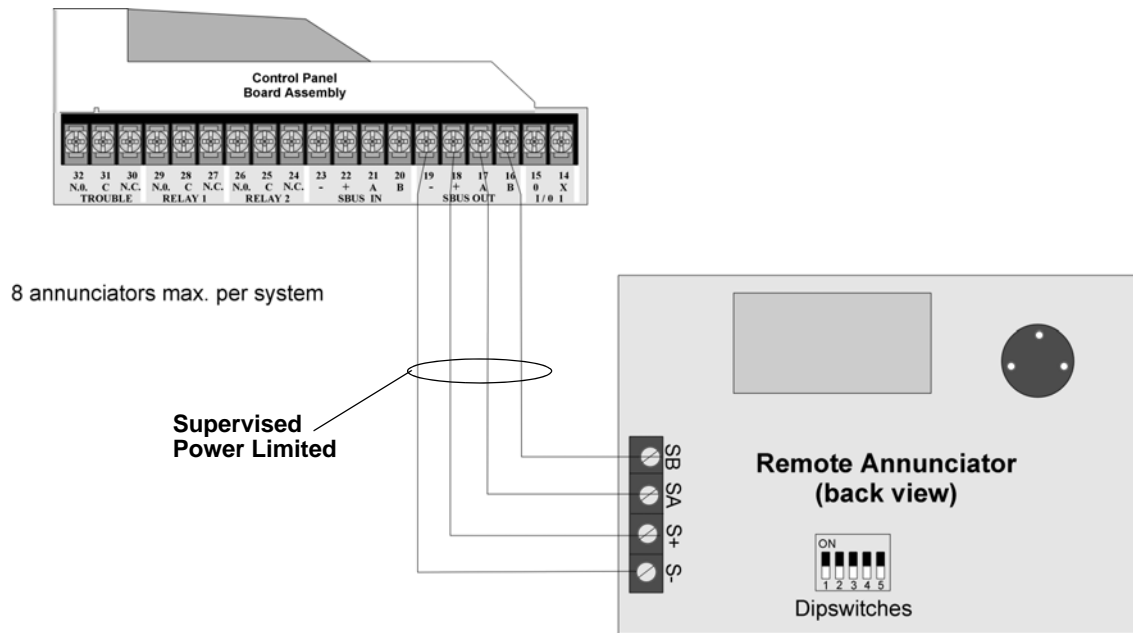

Figure 4-14 Model 5860 Connection to the Panel

4.6 5815XL Installation

The 5815XL SLC expander lets you add 127 addressable devices. Up to three 5815XLs (adding 381 SLC devices for a total of 508 points) can be used with the system.

To install the 5815XL:

1. Make sure power is off at the panel.
2. Mount the 5815XL in the 5820XL, the 5895XL cabinet, or the 5815RMK remote mounting kit. Use the standoffs located under the control panel board assembly and secure with screws provided with the 5815XL. See also *Model 5895XL Installation Instructions* (P/N 151142) or *5815RMK Remote Mounting Kit Installation Instructions* (P/N 151391).
3. Connect the 5815XL to the control panel. (See Section 4.6.1.)
4. Use on-board dipswitches to select an ID#. (See Section 4.10.1.)
5. The new 5815XL module must be added to the system through programming. JumpStart will add the module automatically (see Section 6.1). You can also add it manually (see Section 7.3.2). Select a name, if desired (see Section 7.3.1.1).
6. You are now ready to connect SLC devices to the 5815XL (see Section 5.4).

Figure 4-15 is a drawing of the 5815XL board, showing the location of terminals and dipswitches.

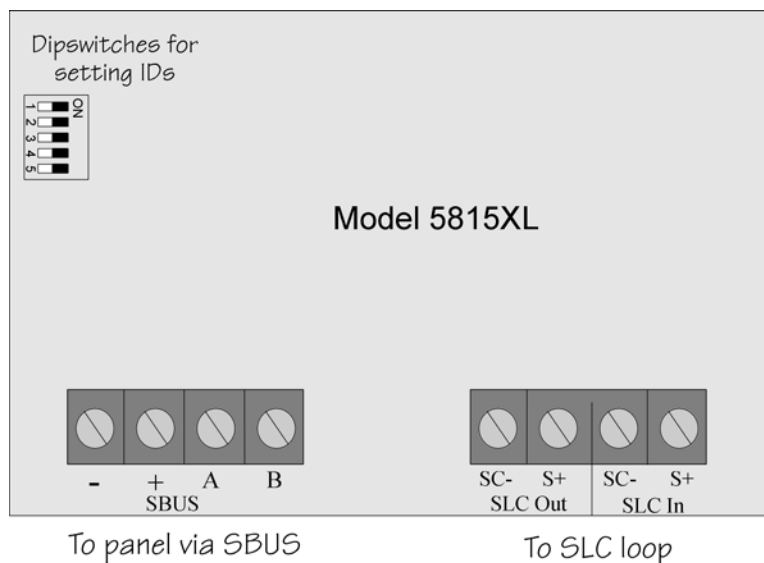

Figure 4-15 5815XL Board

4.6.1 5815XL Connection to the Panel

Connect the 5815XL to the control panel as shown in Figure 4-16. After the 5815XL is connected to the panel, it must be added to the system. This programming step is described in Section 4.10.

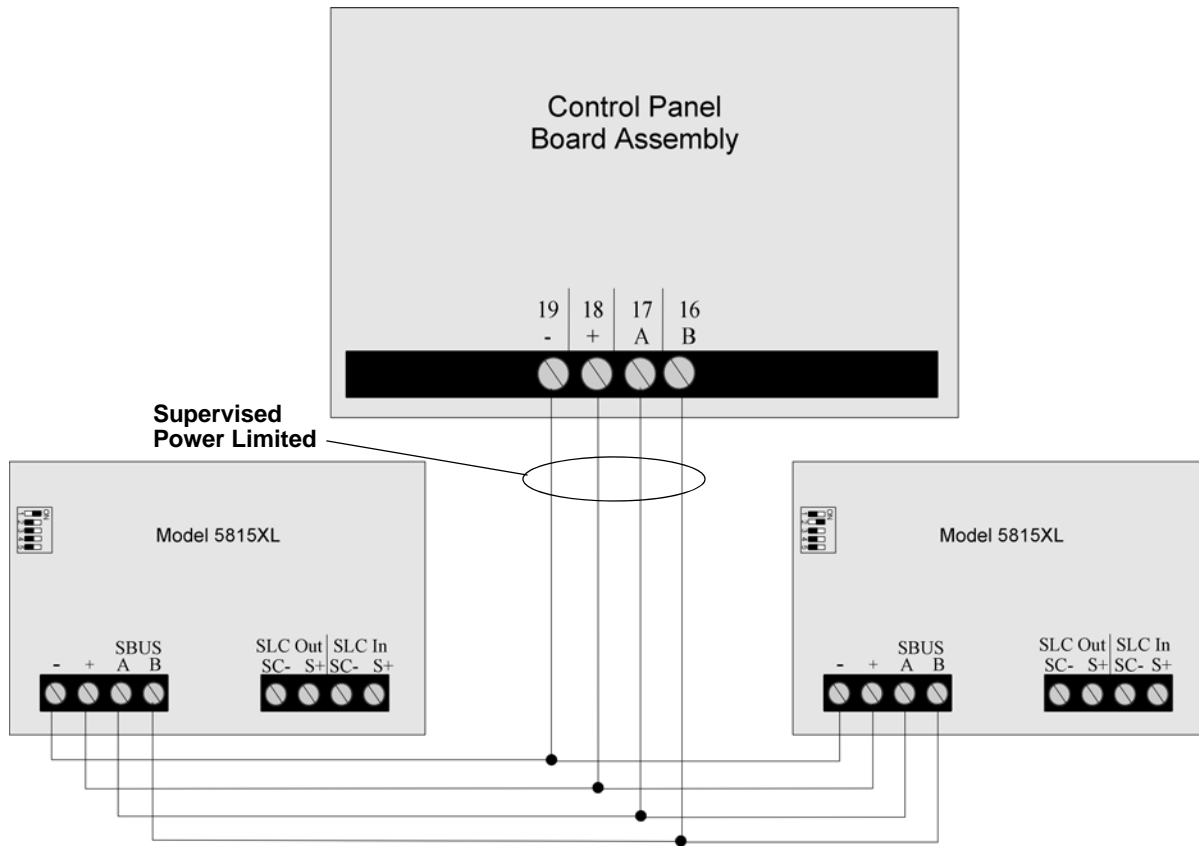

Figure 4-16 5815XL Connection to Main Panel Assembly

4.7 5824 Serial/Parallel Interface Module Installation

The 5824 serial/parallel interface module allows you to connect a printer to the panel, so you can print a real-time log of system events, a report of detector status, and event history. Instructions for installing the 5824 appear below. The 5824 is for ancillary use only.

5824 installation involves the following steps:

1. Make sure power is off at the panel.
2. Connect the 5824 to the panel as shown in Figure 4-17.

Note: Two 5824s per panel maximum.

3. Use the dipswitches on the back of the 5824 board to assign an ID# to the 5824 (see Section 4.10.1).
4. Configure the 5824 device through programming. See Section 4.7.1.
5. Connect a printer to the 5824 as shown in Figure 4-18.

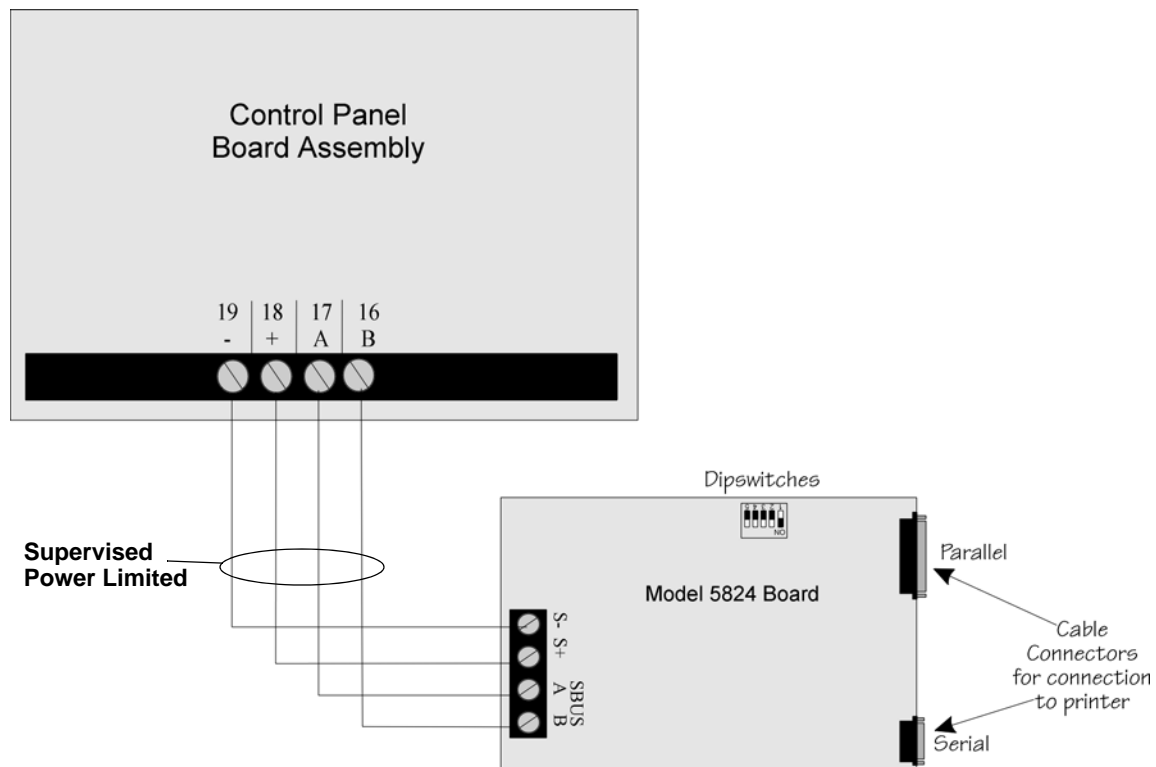

Figure 4-17 5824 Connection to the Panel

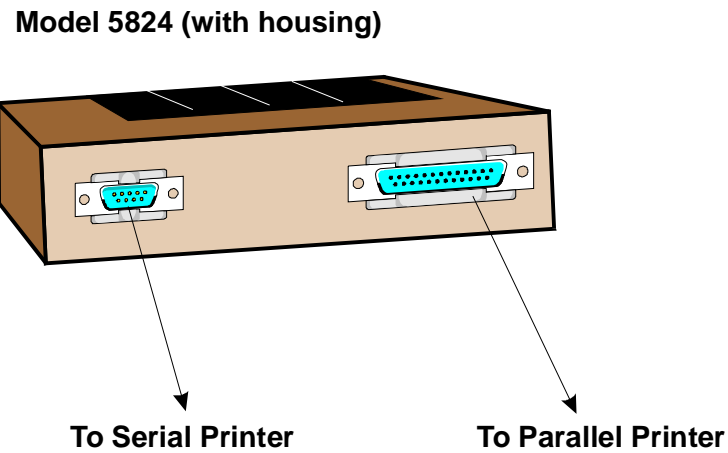

Figure 4-18 Printer Connection

4.7.1 Selecting 5824 Options

Configuring the 5824 includes the following steps:

- Add the module to the system. JumpStart will add the module automatically (see Section 6.1). You can also add it manually (see Section 7.3.2).
- Select a name, if desired (see Section 7.3.1.1).
- Select options for the printer and the output port. See below.

Printer and Output Port Options

1. From the Installer Main Menu, select **[7]** for Program Menu.
2. Select **[1]** for Module.
3. Select **[1]** for Edit Module.
4. From the list that displays, select the 5824 module you want to configure.
5. Press **[ENTER]** **[ENTER]** to bypass the next two screens. A screen similar to the one shown in Figure 4-19 will display.

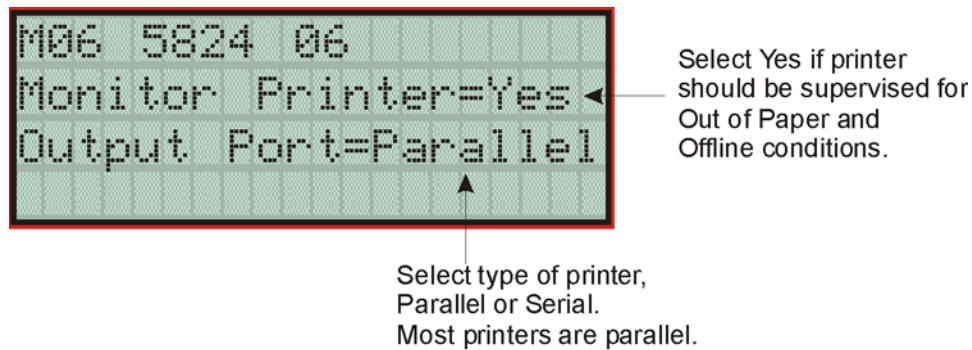

Figure 4-19 Selecting Printer and Output Port Options

6. Select options for the printer as needed for your installation. Most printers are parallel.
7. If you are using a serial printer, use the next screen to select serial port options as required for your printer. Refer to your printer manual if you need more information.

Option	Choices
Baud Rate:	75 - 19200
Data Bits:	5 - 8
Stop Bits:	.5, 1, 2
Parity:	None, Even, Odd

4.8 5880 LED I/O Module

The 5880 is an LED driver board that can be used in a wide variety of applications, including as an interface with most customized floor plan annunciator boards. The 5880 can drive up to 40 LEDs and has one PZT controller. The 5880 also has eight inputs for

monitoring. The following sub-sections describe hardware installation. Refer to Section 6 for programming information.

4.8.1 5880 Board Layout

Figure 4-20 is a picture of the 5880 board showing locations of screw terminals for connection to the panel and contact monitor wiring; pin connectors for connecting LEDs; and the dipswitch for selecting an SBUS ID number.

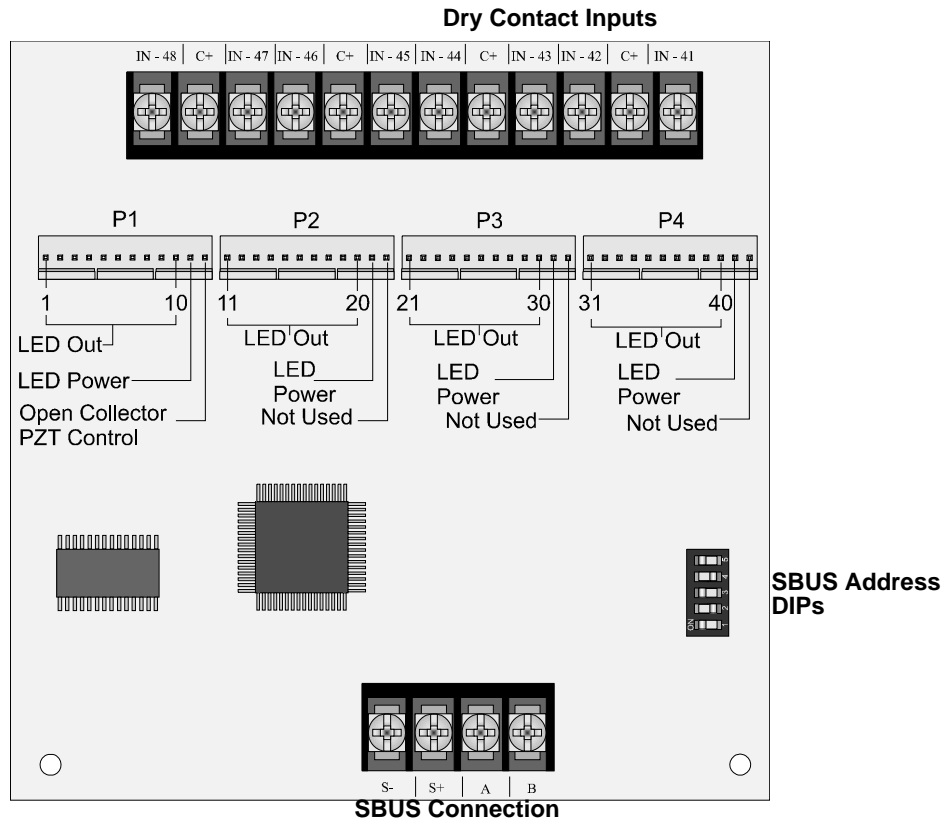

Figure 4-20 5880 Board Layout

4.8.2 FACP Connection

The 5880 connects to the panel via the SBUS. Make connections as shown in Figure 4-21. After the 5880 is connected to the panel, it must be added to the system. This programming step is described in Section 4.10.

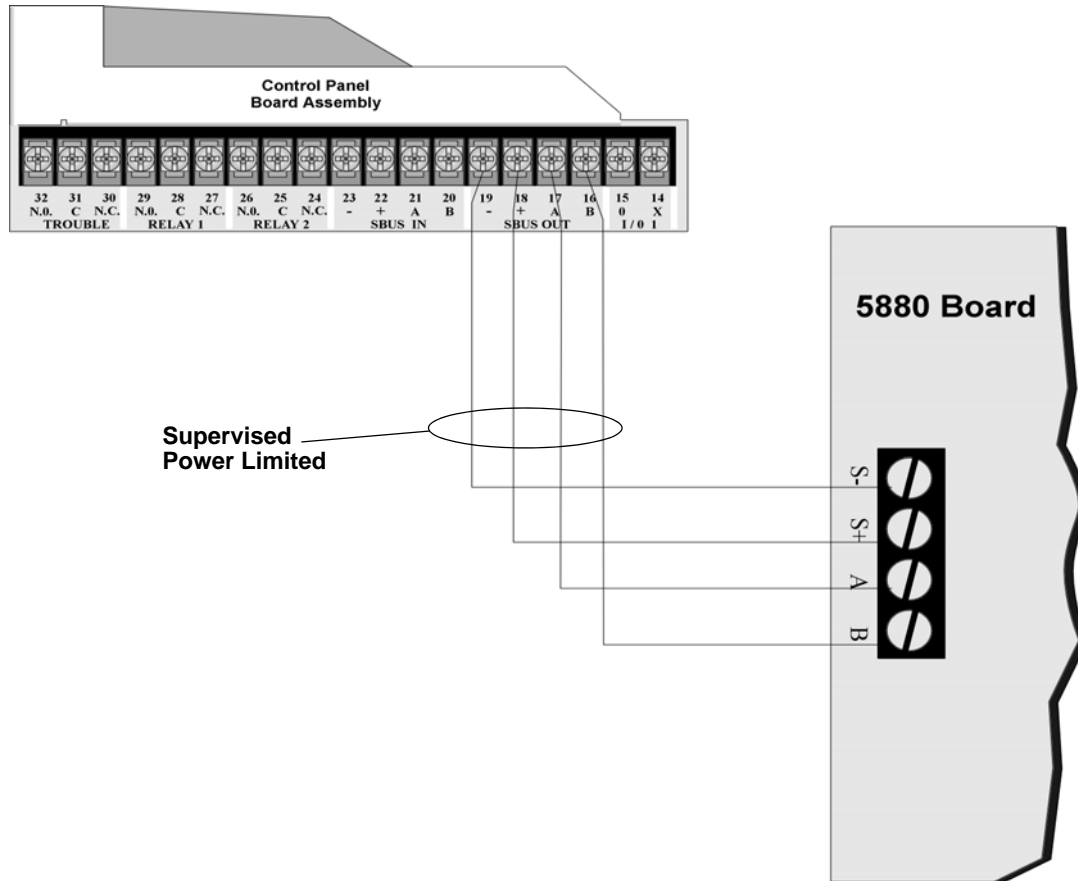

Figure 4-21 5880 Connection to Main Control Panel Assembly

4.8.3 LED Wiring

There are four 12-pin connectors on the 5880 board for connecting LEDs. Each LED gets its power from Pin 11. Internal resistors are sized so that there is approximately 10 mA of current for each LED, no series resistors are required. LED outputs can be mapped to output circuits. See Section 6 for programming details.

Wire the LEDs as shown in Figure 4-22.

On connector P1, Pin 12 is an open collector output for controlling a PZT. If used, the 5880 PZT will match the PZT pattern of the on-board (or 5860) annunciator.

Note: The circuit connected to "Open Collector Output" (last pin on P1) must be current limited so that no more than 100 mA of current is allowed to flow into the open collector transistor.

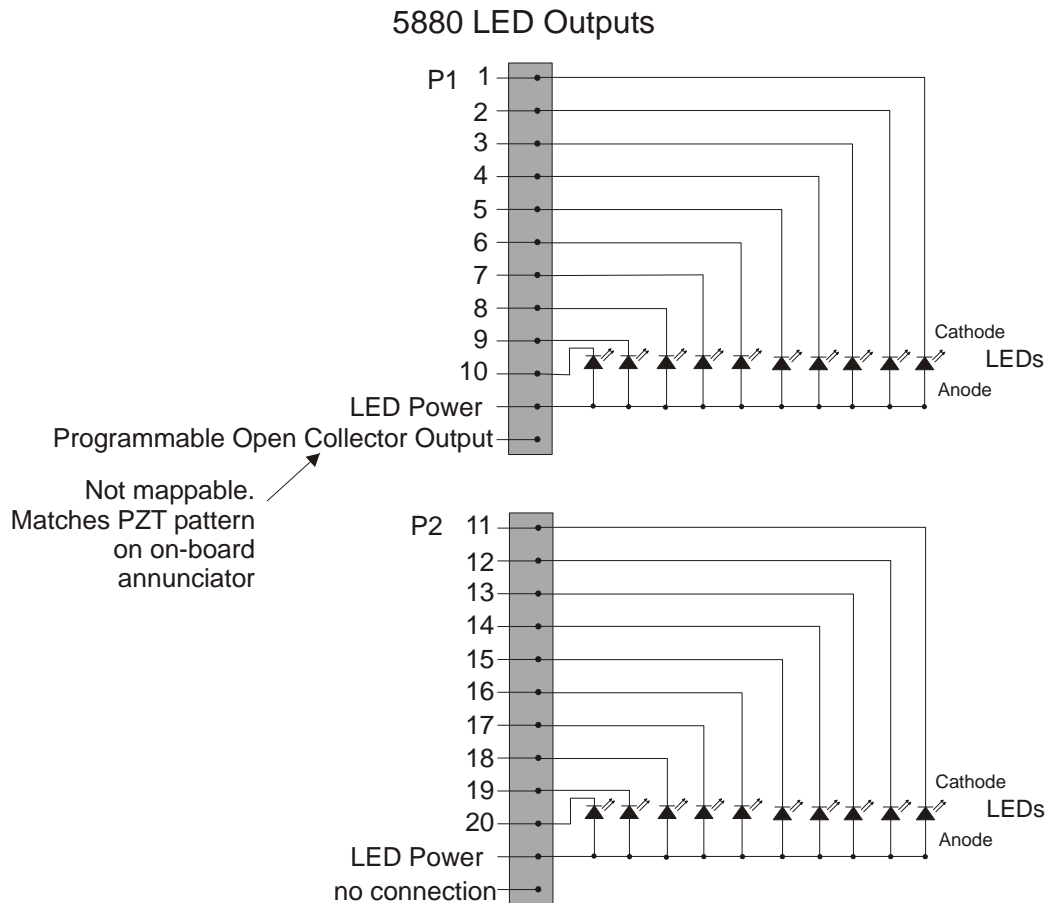

Connectors P3 and P4 wired same as P2.

Figure 4-22 5880 Board Layout

4.8.4 Dry Contact Wiring

The 8 input circuits on the 5880 board are for monitoring switch inputs-any type of switch supported by the control panel can be used with the 5880. For example, you can use a 5880 to monitor pull stations, water flow, tamper, reset, or silence switches.

Wire dry contacts as shown in Figure 4-23. Notice grouping of terminals; power terminals are shared by two inputs.

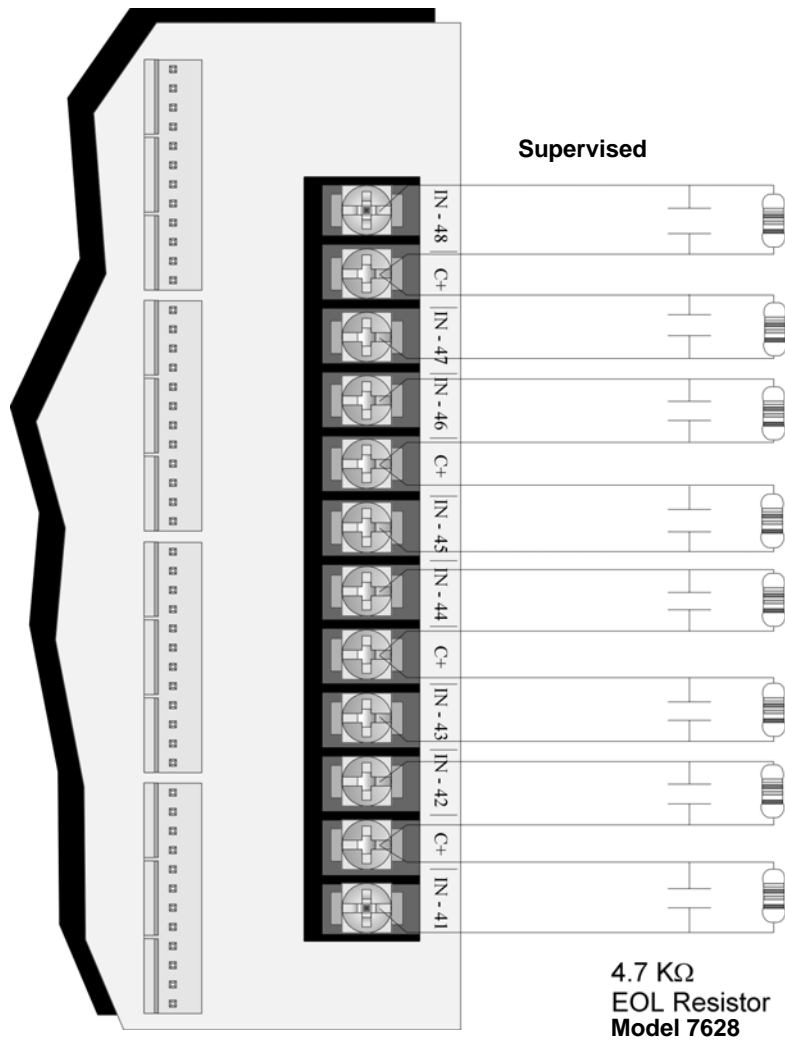

Figure 4-23 Dry Contact Wiring

4.9 5865-3 / 5865-4 LED Annunciator Installation

The 5865-3 and 5865-4 are LED annunciators. The 5865-4 has 30 mappable LEDs, remote silence and reset key switches, and a general system trouble LED. The 5865-3 has 30 mappable LEDs only. These are arranged as 15 pairs of red (typically used for alarm) and yellow (typically used for trouble) LEDs.

Installation of the 5865-5 and 5865-4 is identical. The key switches and the trouble LED follow the behavior of other system annunciators and do not require any installation steps. The following sub-sections describe how to install the 5865-3 and 5865-4 hardware. Refer to Section 6 for programming information.

Note: This manual uses "5865" when referring to aspects of the 5865-3 and 5865-4 that are common to both models.

Numbers indicate point numbers for 5865. (They do not appear on board assembly.)

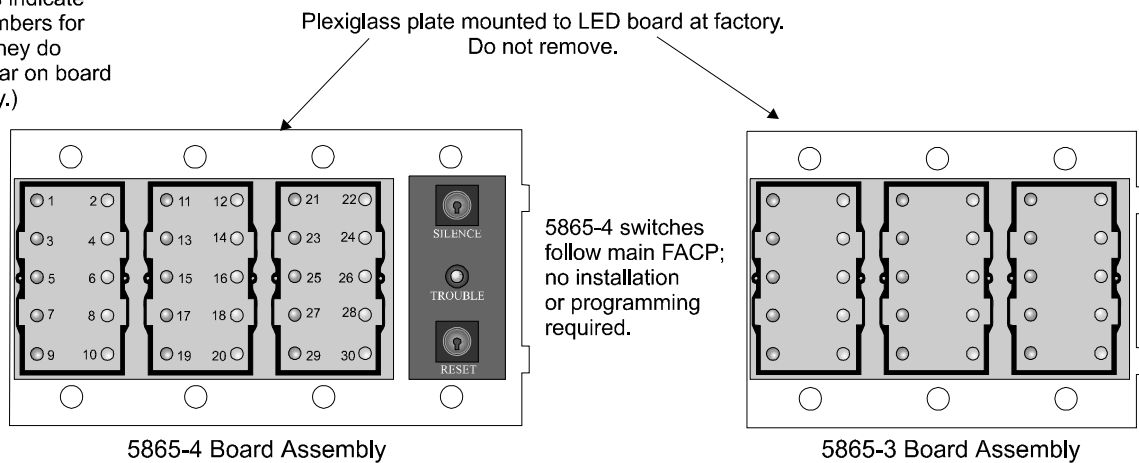

Figure 4-24 5865-3 and 5865-4 Assembly (front view)

4.9.1 FACP Connection

The 5865 connects to the panel via the SBUS. Make connections as shown in Figure 4-25. After the 5865 is connected to the panel, it must be added to the system. This programming step is described in Section 4.10.

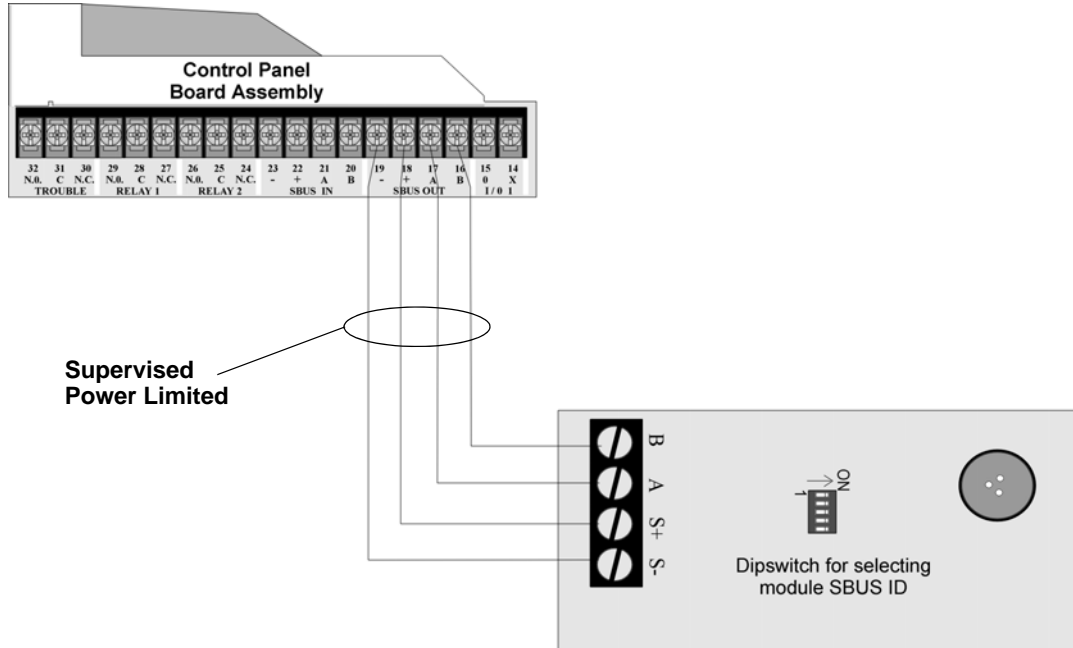

Figure 4-25 5865 Connection to the FACP

4.9.2 5865 Mounting

Mount the 5865-4 to a standard 4-gang electrical box. Mount the 5865-3 to a standard 3-gang electrical box. In Figure 4-26, the 5865-4 attached to a 4-gang box is used as an example.

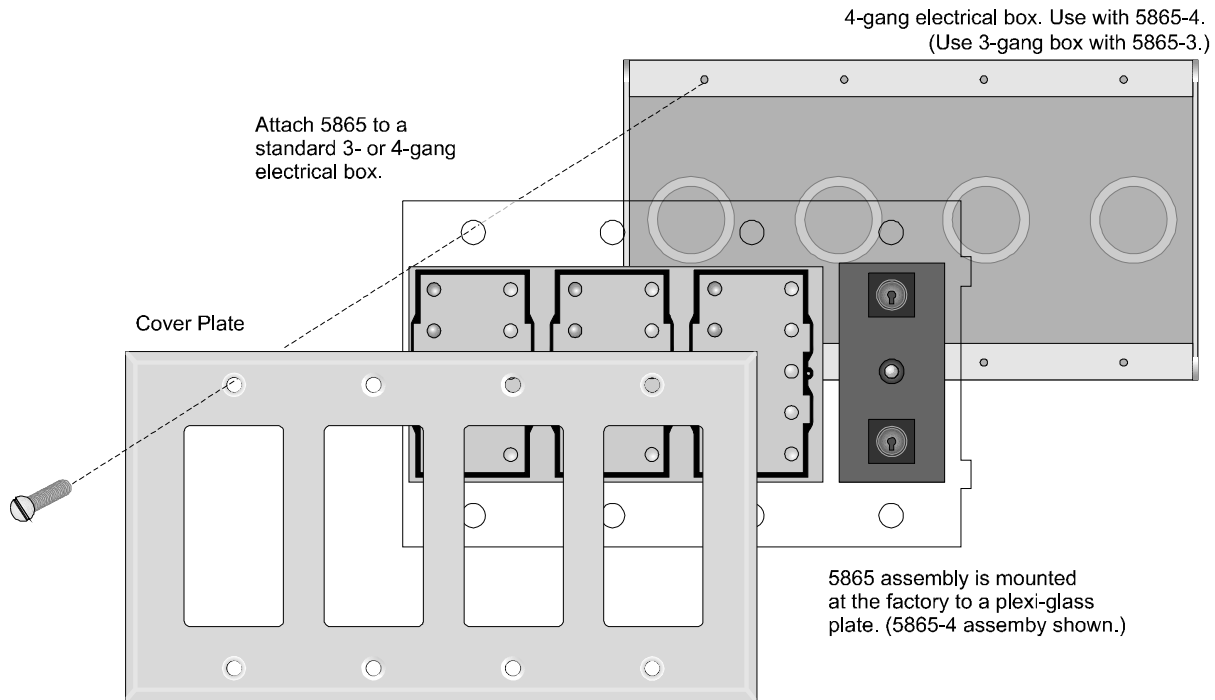

Figure 4-26 5865 Mounting Example

The 5865 ships with a set of zone description labels that can be inserted into the 5865 board assembly. These labels can be used in a typewriter or can be written on by hand. Slide the labels under the plexiglass as shown in Figure 4-27. The LEDs will show through the label when illuminated.

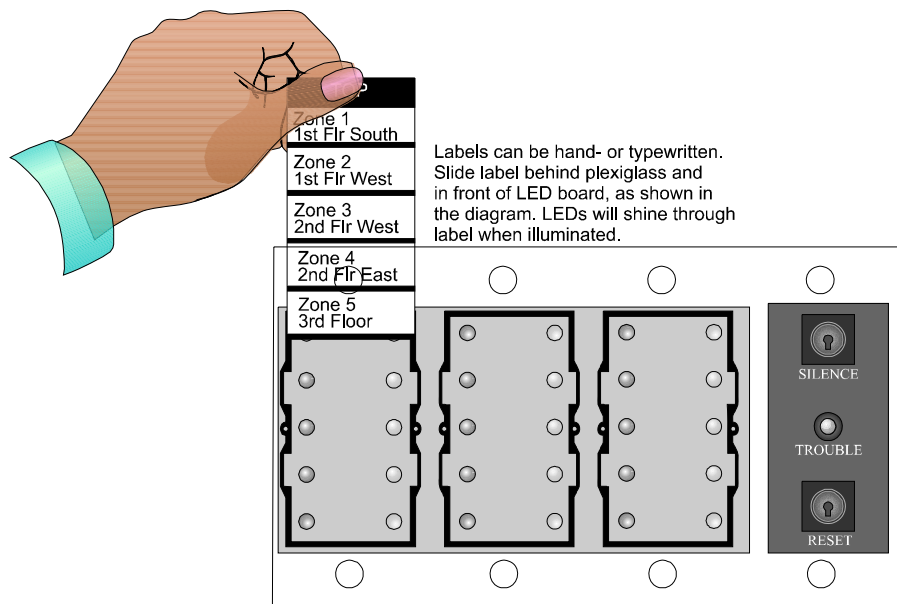

Figure 4-27 Inserting Zone Description Labels

4.10 Configuring Modules

This section describes how to configure any system hardware modules that have been added to the system.

4.10.1 Assigning Module IDs

When installing a hardware module (such as, 5815XL, 5824, 5860, 5895XL, 5865-3 or 5865-4), you must use the dipswitches on the module to assign an ID# to the module.

Figure 4-28 shows all possible dipswitch positions and their correlation to a numerical ID. For example, to select ID 2, place dipswitch 2 in the up position.

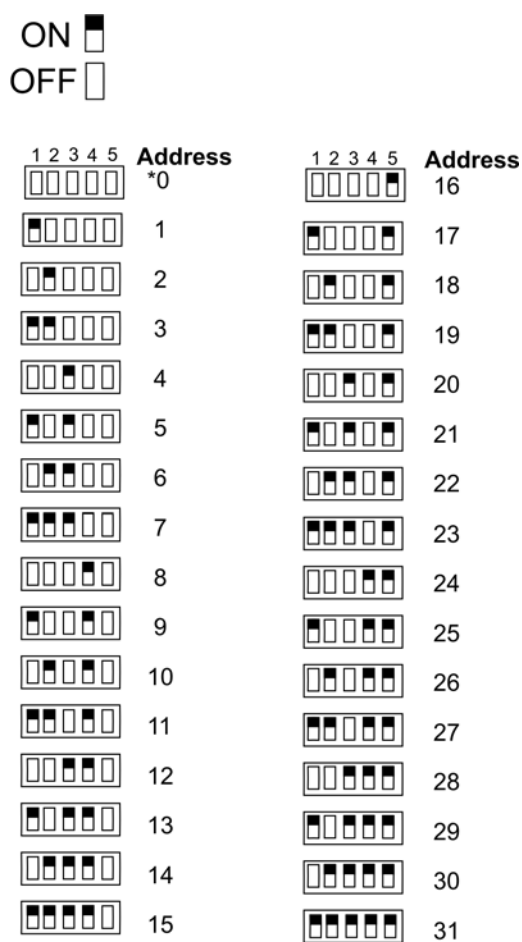

*Note: Address 0 cannot be used.

Figure 4-28 Possible module addresses

Refer to Section 6. to edit, add, delete, and view module list.

4.11 Telephone Connection

Connect the telephone lines as shown in Figure 4-29. The Model 7860 phone cord is available from Silent Knight for this purpose.

A number of programmable options are available for customizing telephone lines. These options are described in Section 7.7.

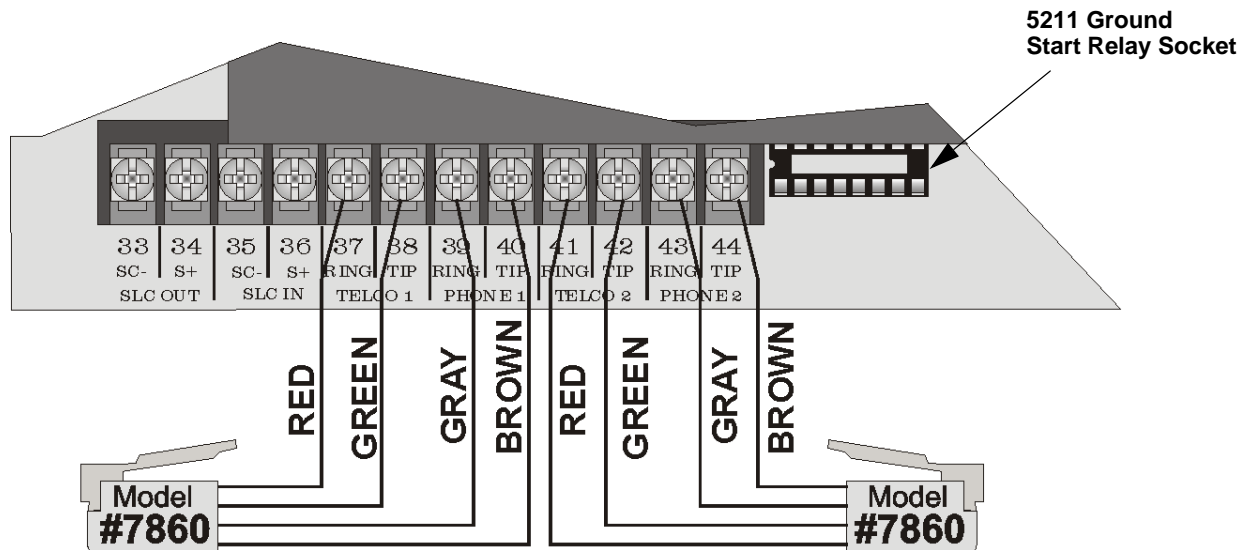

Figure 4-29 Connection of Telephone Lines

4.12 5211 Ground Start Relay

Note: Do not use ground start in UL installations.

If connecting the control panel to a ground start telephone network, you must use the 5211 ground start relay (order separately).

To install the 5211:

1. Install the 5211 on the ground relay socket as shown in Figure 4-29.
2. Enable ground start through the ground start programming option as described in Section 7.7.2.6

4.13 Flexputs™ I/O Circuits

The six Flexput™ circuits are an innovative and versatile feature of the control panel. They can be used as: Class A or B notification circuits, Class A or B initiation circuits (either 2 or 4 wire detectors), or as auxiliary power (resettable, continuous, or door holder).

The polarity of the Flexput terminals differs depending on whether the circuit is programmed as an input or an output circuit. If the circuit is programmed as an input circuit (for a detector or normally open contact) the X terminal is negative and O terminal is positive. If the circuit is programmed as an output circuit (Aux power or NAC) then the X terminal is positive and the O terminal is negative.

This section of the manual explains how to install conventional notification appliances and initiating devices to be used with the system.

4.13.1 Conventional Notification Appliance

This sub-section of the manual explains how to install conventional notification appliances for Class A (Style Z) and Class B (Style Y) configurations.

4.13.1.1 Regulated Class B Notification Wiring

You must use an appliance from the list of compatible appliances in the Appendix A at the back of this manual.

To install a circuit:

1. Wire Class B Notification appliances as shown in Figure 4-30.

- Configure the circuit through programming (see Section 7.6).

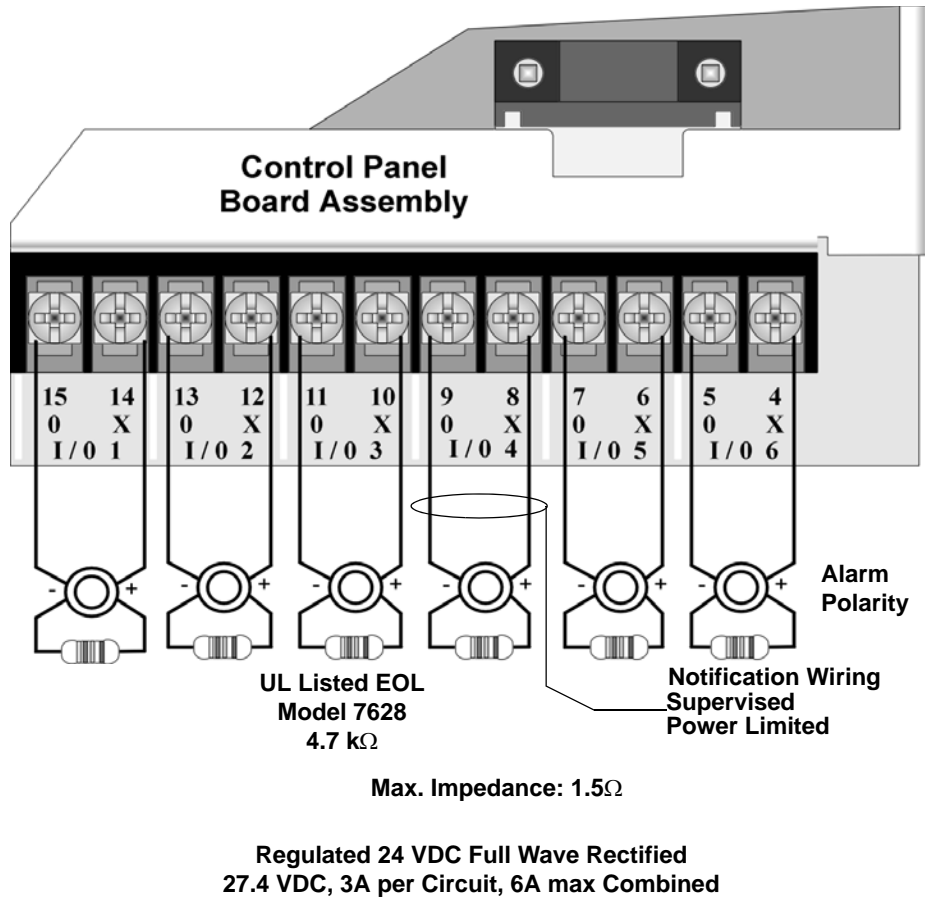

Figure 4-30 Class B Notification Appliance Circuit Wiring

4.13.1.2 Class A Notification Wiring

You must use an appliance from the list of compatible appliances in the Appendix at the back of this manual.

To install a Class A notification appliance circuit:

1. Wire the Class A notification appliances as shown in Figure 4-31.

Caution

For proper system supervision do not use looped wire under terminals marked O and X of the Flexput connectors. Break wire runs to provide supervision of connections.

2. Configure the circuit for Class A in programming (see Section 7.6).

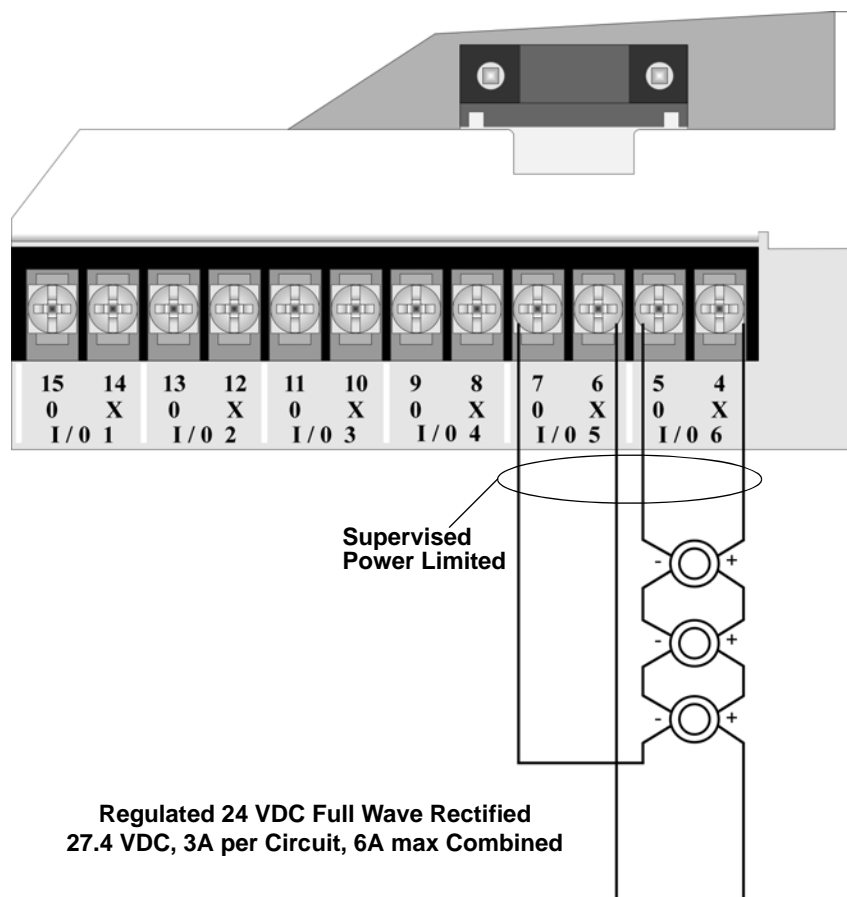

Figure 4-31 Class A Notification Appliance Circuit Configuration

Note: In programming any point that uses multiple Flexput circuits, the lowest Flexput circuit number is used to refer to the circuit pair. For example, Figure 4-31 uses both Flexput circuit 5 and 6, so in programming it would be referred to as point 5.

4.13.2 Conventional Input Switch Circuits

This section of the manual explains how to install conventional initiating devices for Class A (Style D) or Class B (Style B) configurations.

4.13.2.1 Class B Inputs

You can connect conventional Class B switches, such as waterflow switches and pull stations, directly to the Flexput circuits of the control panel.

To install a Class B switch:

1. Wire the Class B switch as shown in Figure 4-32.
2. Configure the circuit through programming (see Section 7.6).

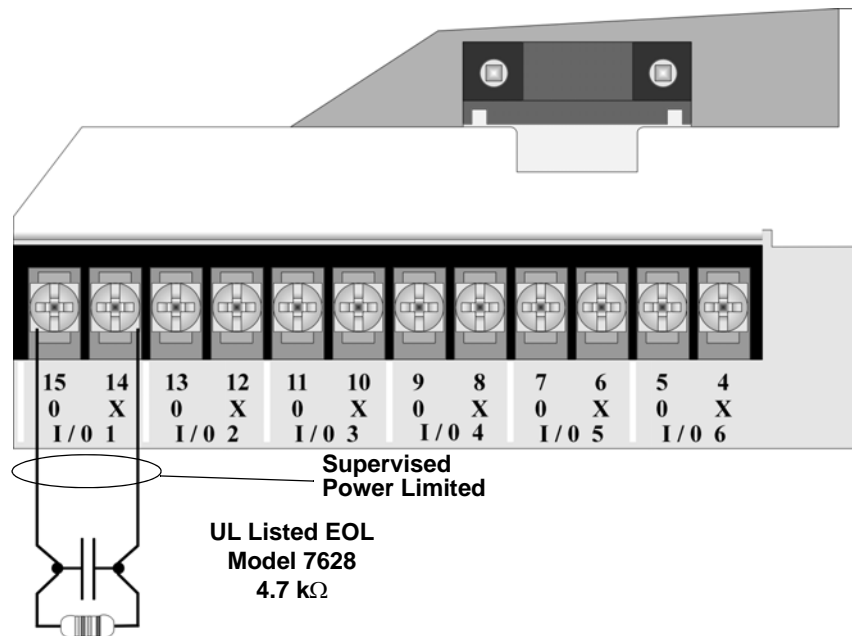

Figure 4-32 Class B Input Switches

4.13.2.2 Class A Inputs

You can connect conventional Class A switches, such as waterflow switches and pull stations, directly to the Flexput circuits of the control panel.

To install a Class A switch:

1. Wire the Class A switch as shown in Figure 4-33.
2. Configure the circuit through programming (see Section 7.6).

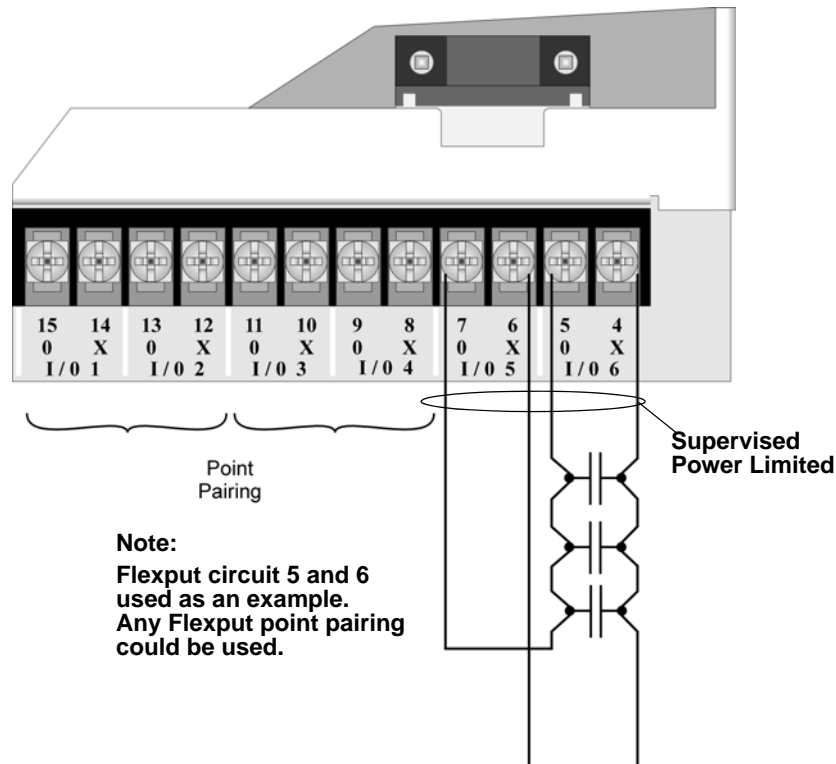

Figure 4-33 Class A initiating Switches

Note: In programming any point that uses multiple Flexput circuits, the lowest Flexput circuit number is used to refer to the circuit pair. For example, Figure 4-33 uses both Flexput circuit 5 and 6, so in programming it would be referred to as point 5.

4.13.3 Installing 2-Wire Smoke Detectors

Any compatible U.L. listed two-wire smoke detector can be used with the control panel (see Appendix A for list of compatible smoke detectors). Figure 4-34 and Figure 4-35 illustrate how to connect a UL listed 2-wire detector to the control panel.

4.13.3.1 Installing 2-Wire Class B Smoke Detectors

To install a Class B two-wire smoke detector, wire as shown in Figure 4-34.

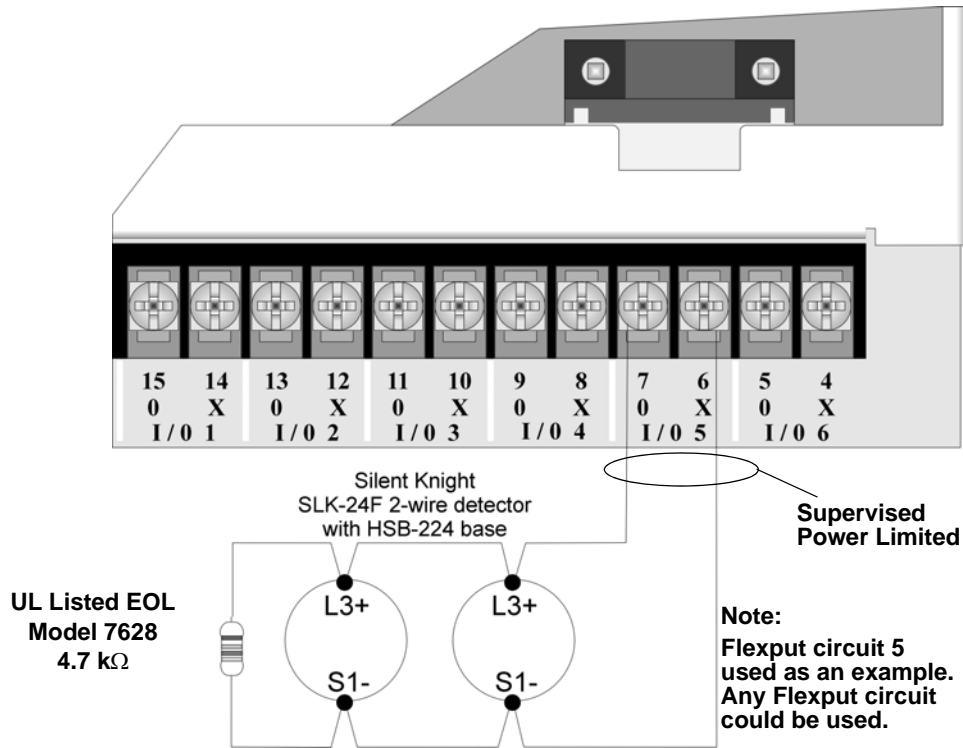

Figure 4-34 Two-Wire Class B Smoke Detector

4.13.3.2 Installing 2-Wire Class A Smoke Detector

To install a Class A two-wire smoke detector, wire as shown in Figure 4-35.

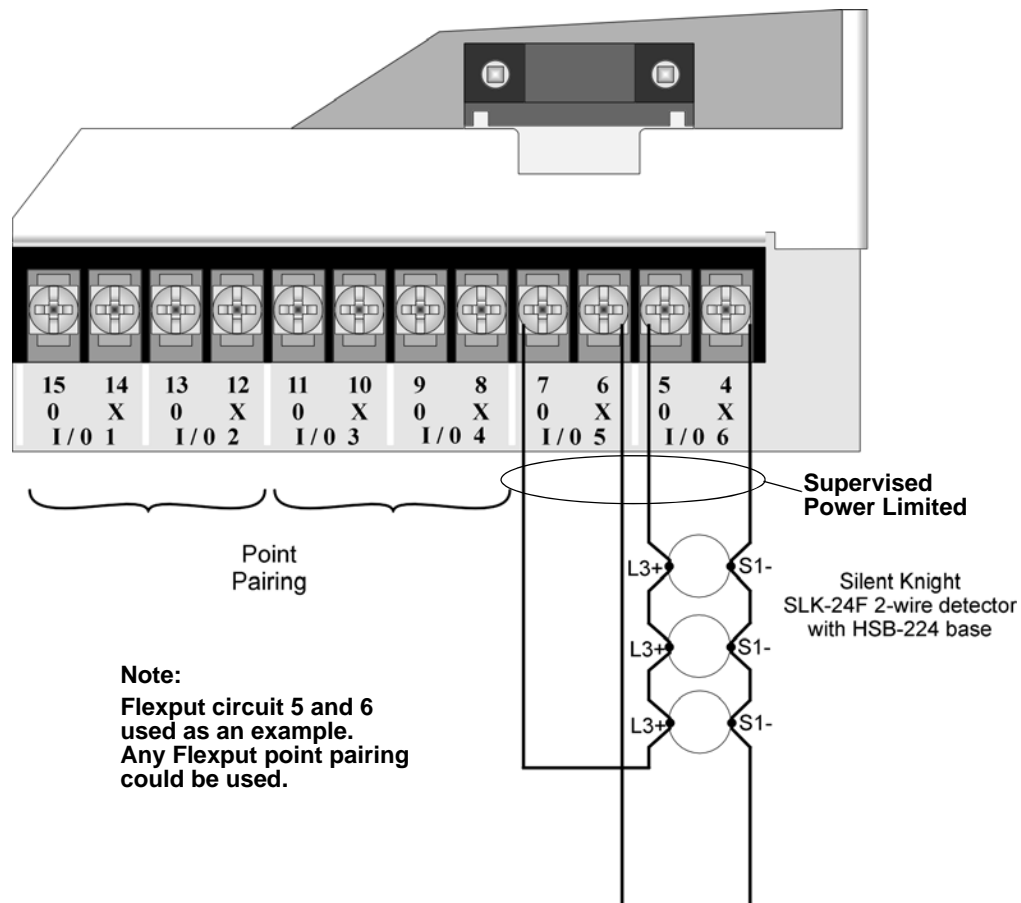

Figure 4-35 Two-Wire Class A Smoke Detector Connections

Note: In programming any point that uses multiple Flexput circuits, the lowest Flexput circuit number is used to refer to the circuit pair. For example, Figure 4-35 uses both Flexput circuit 5 and 6, so in programming it would be referred to as point 5.

4.13.4 Installing 4-Wire Smoke Detectors

Any compatible U.L. listed four-wire smoke detector can be used with the control panel (see Appendix A for list of compatible smoke detectors). Figure 4-34 and Figure 4-35 illustrate how to connect a UL listed four-wire detector to the control panel.

4.13.4.1 Installing a Class B 4-Wire Smoke Detector

Figure 4-36 illustrates how to install a 4-wire Class B smoke detector.

Conventions used for wiring 4-wire Class B loops:

1. Up to three Class B 4-wire smoke detector loops can be connected to the control panel at once.
2. Each Class B loop input is paired with a unique power source as shown in Figure 4-36.
3. Each loop gets smoke power from the even numbered Flexput circuit and the contact input is connected to the odd numbered Flexput circuit.

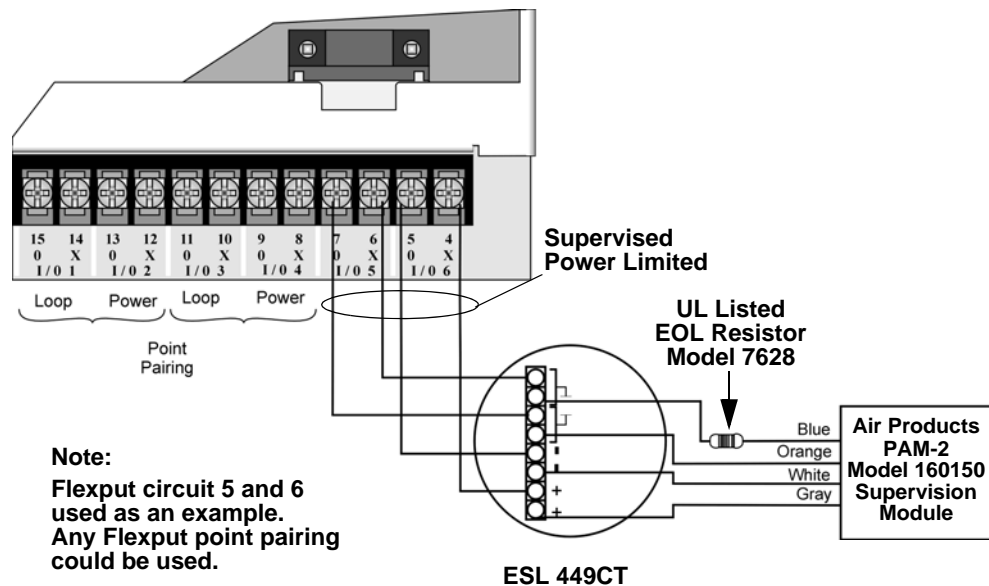

Figure 4-36 Class B 4-Wire Smoke Detector Connections

Note: In programming any point that uses multiple Flexput circuits, the lowest Flexput circuit number is used to refer to the circuit pair. For example, Figure 4-36 uses both Flexput circuit 5 and 6, so in programming it would be referred to as point 5.

4.13.4.2 Installing 4-Wire Class A Smoke Detectors

Figure 4-37 illustrates how to install 4-wire Class A detectors.

Conventions used for wiring 4-wire Class A loops:

1. Up to two Class A 4-wire loops can be connected to the control panel at once.
2. Smoke power is supplied to each Class A loop as shown in Figure 4-37.

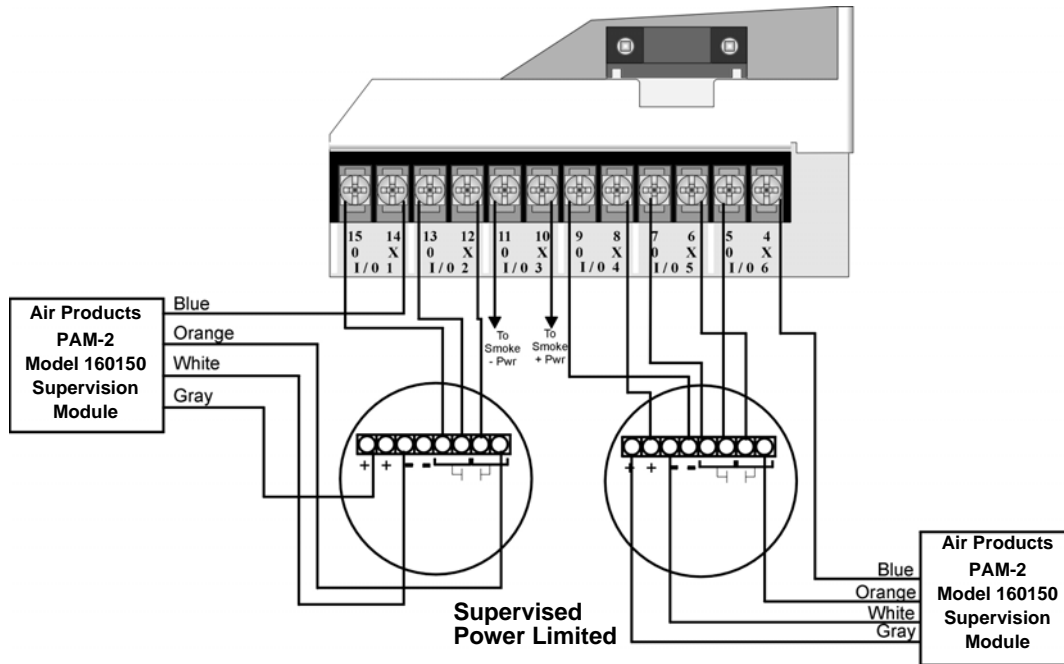

Figure 4-37 Class A 4-Wire Smoke Detector Connections

Note: In programming any point that uses multiple Flexput circuits are always referred to as the lowest Flexput circuit number used. For example, Figure 4-37 uses Flexput circuits 1, 2, 3 together and 4, 5, 6 together. In programming (1, 2, 3) would be referred to as point 1, and (4, 5, 6) would be referred to as point 4.

4.13.5 Auxiliary Power Installation

Flexput Circuits 1-6 on the control panel can be used as auxiliary power circuits. The three types of auxiliary power available are:

- Door Holder (see Section 4.13.5.1)
- Constant (see Section 4.13.5.2)
- Resettable Power (see Section 4.13.5.3)

Auxiliary power circuits are power limited. Each circuit can source up to 3A (total current for all Flexput circuits must not exceed 6.0 A).

To install an auxiliary power circuit:

1. Wire the Flexput circuit(s) that will be used for auxiliary power. See Figure 4-38 for location of Flexput circuits.
2. Configure the auxiliary power output through programming (see Section 7.6).

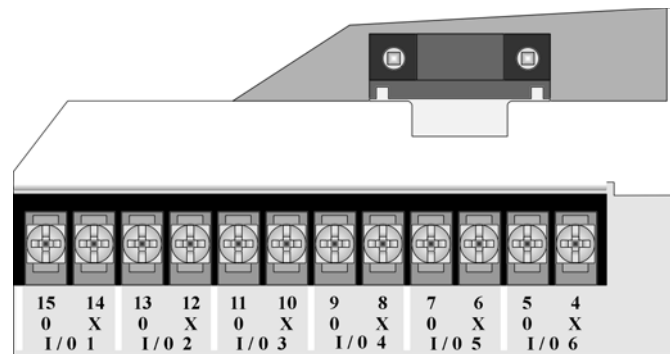

When used as auxiliary power, terminals labeled "0" are negative, terminals labeled "X" are positive.

Figure 4-38 Flexput Circuit Location

4.13.5.1 Door Holder Power

Door holder power is intended for fire door applications. When there are no alarms in the system and the panel has AC power, door holder circuits have 24-volt power present at their terminals. Any alarm will cause power to disconnect. Power will be re-applied when the system is reset. If AC power is off for more than 15 seconds, the auxiliary door holder power will be disconnected to conserve the battery backup. When AC power is restored, power is immediately restored to the door holder circuits.

Use a UL listed door holder ESL DHX-1224, for this application.

4.13.5.2 Constant Power

Use constant power for applications that require a constant auxiliary power source. Power is always present at Constant circuits.

4.13.5.3 Resettable Power

Resettable power is typically used to power beam detectors, flame detectors and conventional 4-wire smoke detectors. For circuits selected as Resettable, 24-volt power is always present at the terminals unless a system reset occurs. If a system reset occurs, power is disconnected from the terminals for 30 seconds, then re-applied.

4.14 On-Board Relays (Conventional)

The control panel has two built-in programmable relays and a built-in trouble relay. All relays are Form C rated at 2.5 A @ 24 VDC.

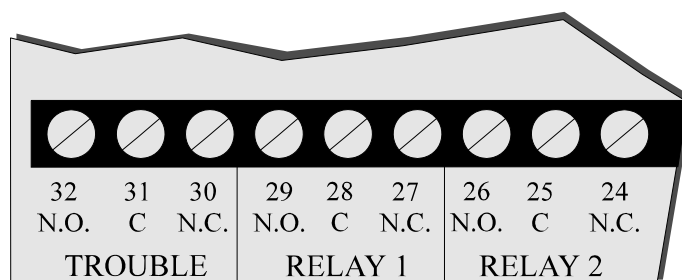

Figure 4-39 Location of Conventional Relay Circuits

4.14.1 Trouble Relay

The control panel has a dedicated Form C trouble relay built into terminals 30-32. The relay provides a normally open and a normally closed contact. The trouble relay will deactivate under any trouble condition.

Note: The N.C. contact is the relay contact that is closed when the panel has power and there are no trouble conditions.

4.14.2 Programmable Relays

The control panel has two Form C programmable relays built into terminals 24-29. Each relay provides a normally open and a normally closed contact.

To install one or two programmable relays, follow these steps.

1. Wire Relay 1 and/or Relay 2 as needed for your application. See Figure 4-39 for the location of the relay terminals.
2. Configure the relay through programming (see Section 7.6).

4.15 Remote Station Applications

4.15.1 Keltron Model 3158 Installation

The control panel is compatible with Keltron Model 3158, used for direct connection to a Keltron receiver. The 3158 reports alarms, supervisories, and troubles.

The steps for connecting the 3158 to the control panel. Refer to the 3158 installation instructions for complete information.

1. Wire the 3158 to the control panel as shown in the connection list and Figure 4-40.
2. Wire the 3158 within 20 feet of the control panel. Wiring must be enclosed in conduit.
3. Program control panel Relay 1 for alarm.
4. Program Flexput circuit 5 for alarm.
5. Program Flexput circuit 6 for supervisory non latching.

Table 4-3: Keltron 3158 to Control Panel Connections

Terminal #	Connects To
3158 Term. 1	To Keltron receiving equipment
3158 Term. 2	To Keltron receiving equipment
3158 Term. 3	Earth ground
3158 Term. 4	Not used; no connection.
3158 Term. 5	Control panel Term. 18
3158 Term. 6	Control panel Term. 19
3158 Term. 7	Control panel Term. 7

Terminal #	Connects To
3158 Term. 8	Control panel Term. 28
3158 Term. 9	Control panel Term. 5
3158 Term. 10	Control panel Term. 4
Control panel Term. 6	Control panel Term. 29
Control panel Term. 28	Control panel Term. 31
Control panel Term. 29	Control panel Term. 30

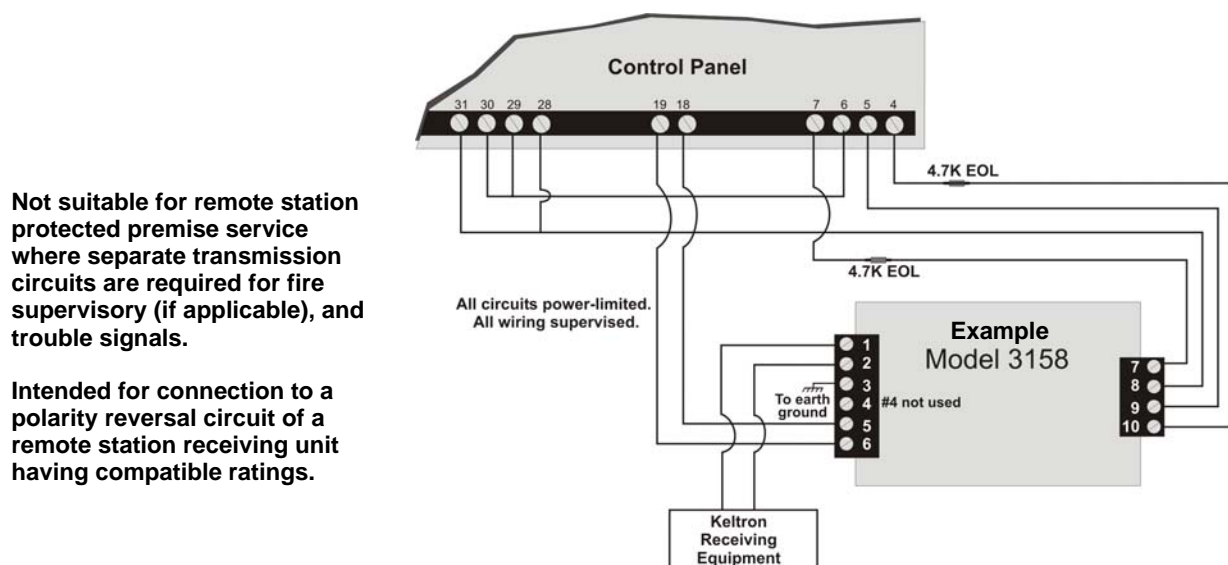

Figure 4-40 Keltron 3158 Connection to Control Panel

4.15.2 City Box Connection Using the 5220 Module

This section describes how to connect the control panel to a local energy municipal fire alarm box or “city box” as required by NFPA 72 Auxiliary Protected Fire Alarm systems for fire alarm service. The city (master) box is an enclosure that contains a manually operated transmitter used to send an alarm to the municipal communication center which houses the central operating part of the fire alarm system.

City Box Standby Current: 0 (Notification supervision current accounted for in control panel draw.)

Alarm Current: 1 Amp for 1 second
27.2 VDC max

The maximum coil and wire resistance (combined) must not exceed 30 ohms.

To install the 5220 for city box connection:

1. Use one of the knockouts on the right side of the control panel to connect the 5220 using a short piece of conduit (must not exceed 20 feet in length).
2. Wire the 5220 to the control panel as shown in Figure 4-41. This drawing also shows how to connect the city box coil to terminals 3 and 4 on the 5220. Do not install an EOL resistor in the terminals of the Flexput circuit used for this application.
3. Connect earth ground wire to the 5220 chassis with mounting screw.
4. Program the Flexput circuit used as a notification circuit, continuous and non-silencing. Refer to Section 7.6.1 for zone grouping and mapping.

It is not possible to reset the remote indication until you clear the condition and reset the control panel.

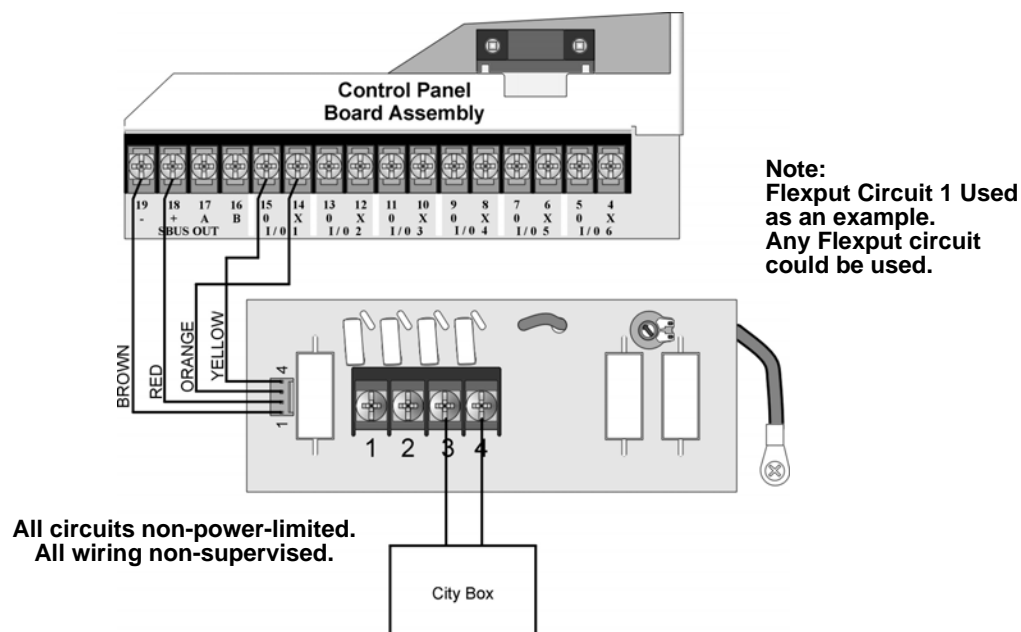

Figure 4-41 City Box Connection

4.15.3 NFPA 72 Polarity Reversal

Note: Intended for connection to a polarity reversal circuit of a control unit at the protected premises having compatible rating.

4.15.3.1 Using the 5220 Module

When the 5220 is wired and programmed for polarity reversal, it reports alarm and trouble events to a remote site. Alarms will override trouble conditions and it will not be possible to reset the remote indicator until the condition is cleared and the control panel is reset.

If an alarm condition occurs, the alarm relay will close, overriding the trouble condition.

Standby Current: 100 mA, 24 VDC

Alarm: 100 mA, 24 VDC

To install the 5220 for polarity reversal, follow the steps below:

1. Locate the knockout on the right side of the control panel cabinet to connect the 5220 using a short piece of conduit (must not exceed 20 feet in length).
2. Wire the 5220 to the control panel using the four-wire pigtail provided as shown in Figure 4-42. This diagram also shows how to connect the 5220 to the remote indicator. Do not install an EOL resistor in the terminals of the Flexput circuit used for this application.
3. Connect earth ground wire to the 5220 chassis with mounting screw.
4. Program the Flexput circuit used as a notification circuit, continuous and non-silencing. Refer to Section 7.4.1 for zone grouping and mapping.
5. If necessary, adjust loop current using the potentiometer (R10) on the 5220 board. Normal loop current is 2-to-8 mA with a 1k ohm remote station receiving unit. Maximum loop resistance is 3k ohm.

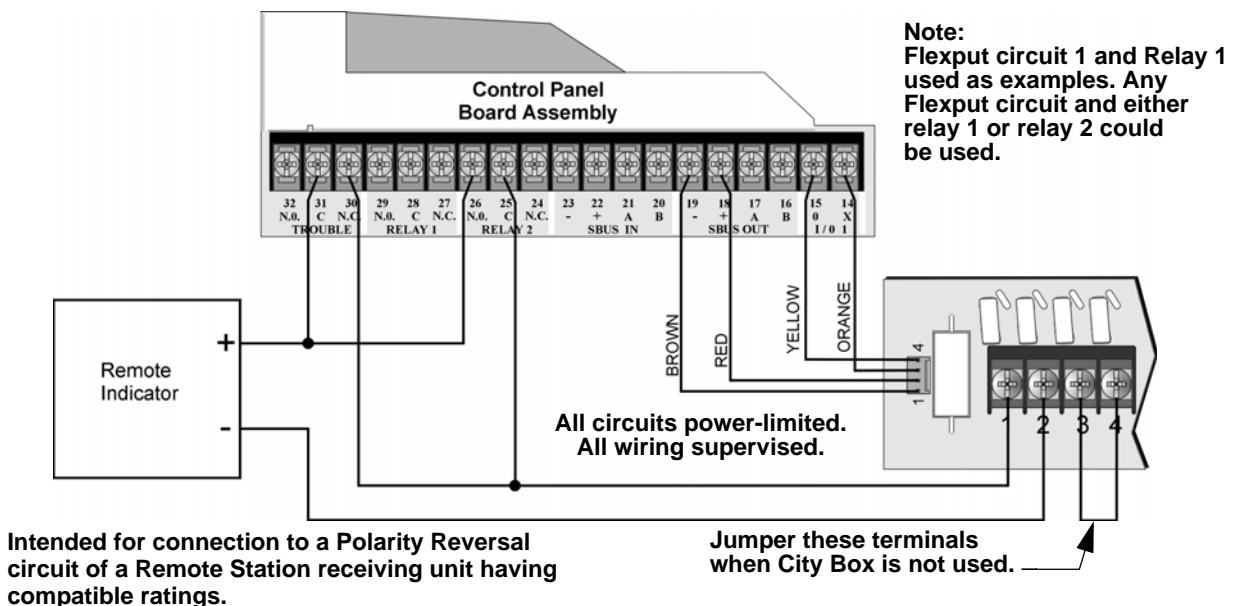

Figure 4-42 Polarity Reversal Connection Using the 5220 Module

4.15.3.2 Using the 7644 Module

When the 7644 is used for polarity reversal, it allows alarm and trouble events to be reported to a remote site. Alarms will override trouble conditions and it will not be possible to reset the remote indicator until the condition is cleared and the control panel is reset.

To install the 7644 for polarity reversal:

1. Wire the 7644 to the control panel as shown in Figure 4-43. Do not install an EOL resistor on the terminals of the Flexput circuit used.

Note: Use only Flexput circuits on the control panel for reverse polarity.

2. Program the Flexput circuit as a notification circuit. See Section 7.6.2.
3. Map the group to activate constant on from the zone event. See Section 7.4.1.3.
4. Program the output group characteristics as non-silenceable and reverse polarity. See Section 7.5.1.2.

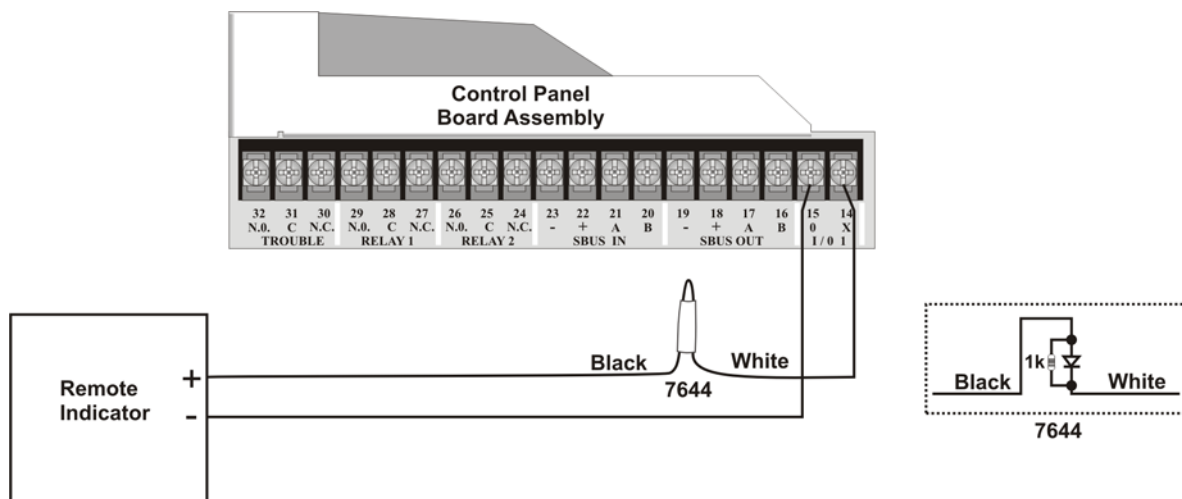

Figure 4-43 Polarity Reversal Connection Using the 7644

4.15.4 Using the SD500-ARM Addressable Relay Module

When the SD500-ARM is wired for polarity reversal, it reports alarm and trouble events to a remote site. Alarms will override trouble conditions and it will not be possible to reset the remote indicator until the condition is cleared and the control panel is reset.

Wire the SD500-ARM as shown in Figure 4-44.

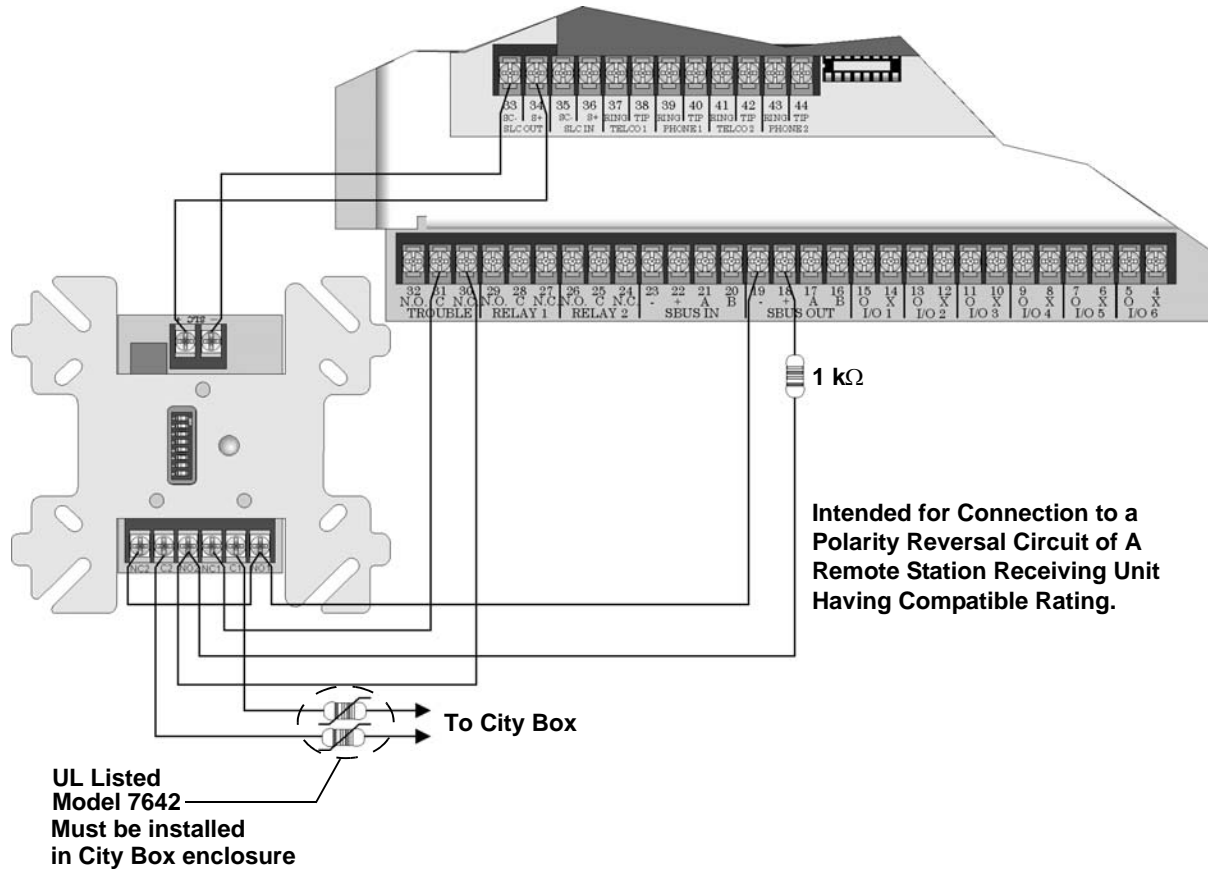

Figure 4-44 Polarity Reversal Connection Using the SD500-ARM Module

4.15.5 Using a MR-201/T Control Relay From Air Products

When the MR-201/T control relay is wired for polarity reversal, it reports alarm and trouble events to a remote site. Alarms will override trouble conditions and it will not be possible to reset the remote indicator until the condition is cleared and the control panel is reset.

If an alarm condition occurs, the alarm relay will close, overriding the trouble condition.

- Current: 15 mA max.
- Operating Voltage: 24 VDC nominal
- Resistance: 4 KΩ

To install the MR-201/T for polarity reversal, follow the steps below:

1. Wire the MR-201/T as shown in Figure 4-45.

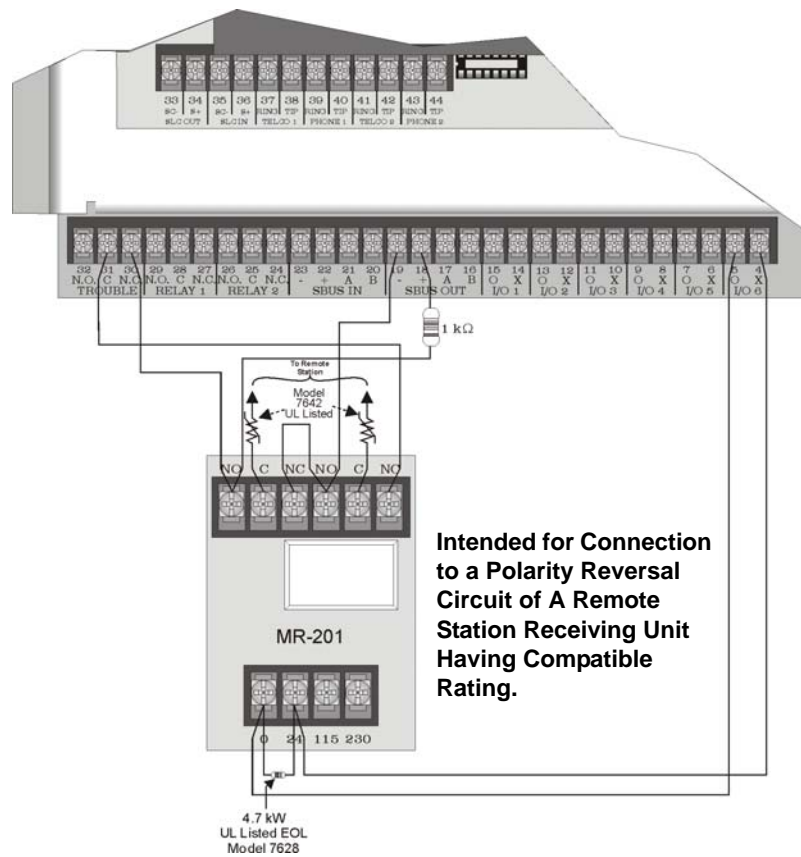
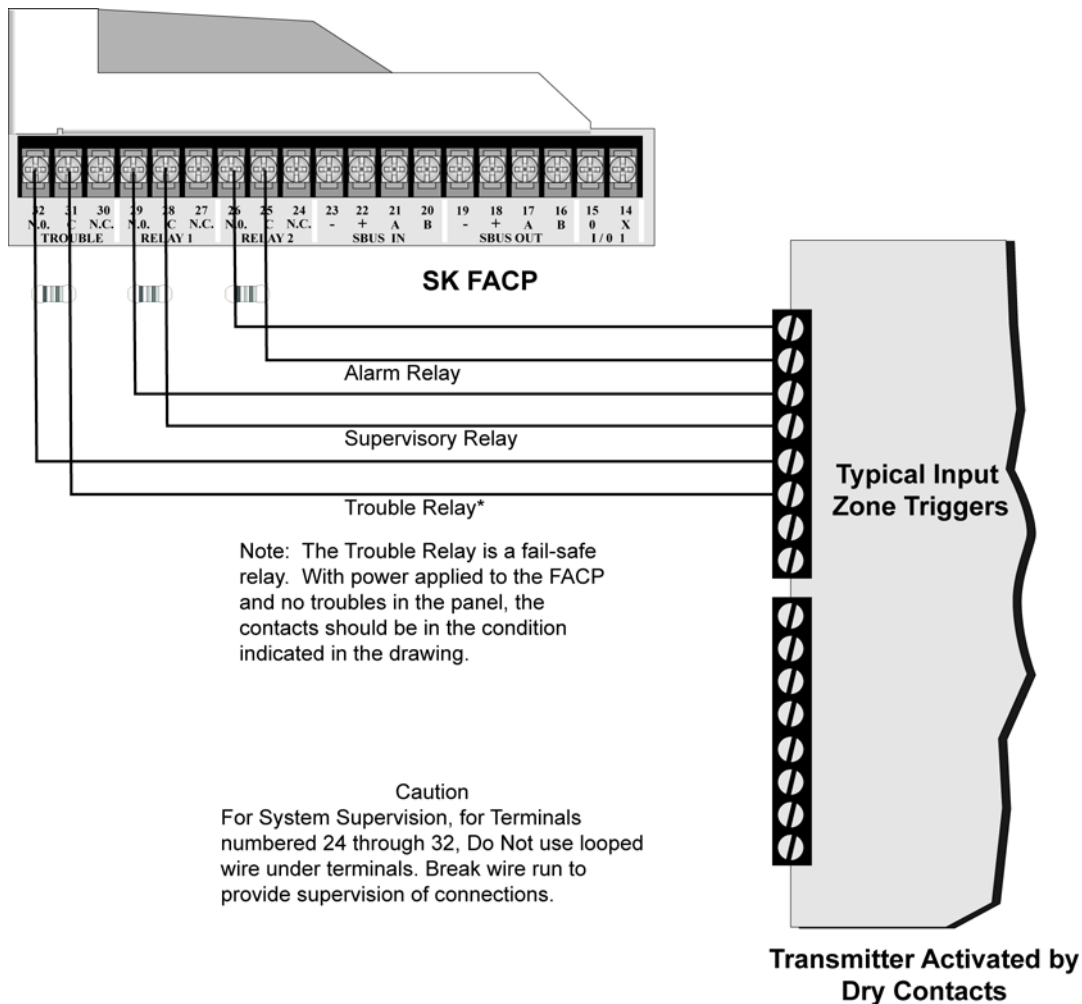

Figure 4-45 Wiring the MR-201/T

2. Program the Flexput circuit for non silence NAC circuit (see Section 7.6).

4.15.6 Transmitter Activated by Dry Contacts

This section describes the connection of a UL 864 listed remote station transmitter to the 5820XL FACP dry contacts. The FACP contacts must be supervised by the remote station transmitter module using end-of-line resistors (ELRs) with a value determined by the transmitter manufacturer. Power is also provided by the remote station transmitter manufacturer. Refer to the remote station transmitter manufacturer's manual for details.



Section 5

Hochiki and SK SLC Device Installation

Caution!

To avoid the risk of electrical shock and damage to the unit, power should be OFF at the control panel while installing or servicing.

5.1 List of SK SLC Devices

The following SK SLC devices can be used with the control panel. See the device installation instructions for more information (packaged with the device).

Note: The control panel supports the use of either SK SLC devices or Hochiki SLC devices. You cannot install both SLC device types on the control panel.

SK Part Number	Model Name/Description	Section/ Install Sheet PN
SK-Photo	Photoelectric smoke detector	156-3426-001
SK-Photo-T	Photoelectric smoke detector with thermal (135°F)	
SK-Acclimate	Multicriteria photoelectric smoke detector with thermal (135°F)	
SK-Beam	Reflected beam smoke detector without test feature	156-3433-001
SK-Beam-T	Reflected beam smoke detector with test feature	
SK-Ion	Ionization smoke detector	156-3428-001
SK-Duct	Photoelectric duct smoke detector with extended air speed range	156-3432-000
SK-Heat	Fixed temperature thermal detector (135°F)	156-3429-000
SK-Heat-ROR	Rate-of-rise thermal detector with 135° fixed temperature	
SK-Heat-HT	Fixed high temperature thermal detector (190°F)	
SK-Pull-SA	Addressable single action pull station	156-3446-001
SK-Pull-DA	Addressable dual action pull station	156-3447-001
SK-Iso	Fault isolator module	156-3445-000
SK-Monitor	Monitor module	156-3442-000
SK-Minimon	Mini monitor module	156-3444-000
SK-Monitor-2	Dual input monitor module	156-3435-000
SK-Mon-10	10 input monitor module	156-3443-000
SK-Relay	Addressable relay module	156-3438-000
SK-Relay-6	Six relay control module	156-3439-000
SK-Zone	Addressable zone interface module	156-3440-000
SK-Zone-6	Six zone interface module	156-3441-000
SK-Control	Supervised control module	156-3436-000
SK-Control-6	Six circuit supervised control module	156-3437-000
B201LP	6" mounting base	K200-07-00
B224BI	6" isolator base	D450-15-00
B224RB	6" relay base	D450-16-01
B501BHT-2	6" temporal sounder base	D550-06-00
B501	4" mounting base	D550-02-00

5.2 List of Hochiki SLC Devices

The following Hochiki SLC devices can be used with the control panel. See the appropriate section number in this manual or the device installation instructions (packaged with the device) for more information.

Note: The control panel supports the use of either Hochiki SLC devices or SK SLC devices. You cannot install both SLC device types on this control panel.

Model Number	Model Name/Description	Section No./ Installation Instructions PN
SD505-APS	Photoelectric smoke detector.	Section 5.7
SD505-AIS	Ionization smoke detector	
SD505-AHS	Absolute temperature heat detector. Trip point range from 135°F–150°F (0°C–37°C).	
SD505-6AB	6" base for use with the SD505-AHS, SD505-AIS, and SD505-APS.	150955
SD505-6IB	6" short circuit isolator base for use with the SD505-AHS, SD505-AIS, and SD505-APS	151175
SD505-6RB	6" relay base for use with the SD505-AHS, SD505-AIS, and SD505-APS	151192
SD505-6SB	6" sounder base for use with the SD505-AHS, SD505-AIS, and SD505-APS SLC devices	151191
SD505-DUCT	Duct Smoke Detector. Duct Housing including the SD505-APS Analog Photoelectric Smoke Sensor. Intake tubing for duct available in three lengths: SD505-T2.5 (2.5 foot); SD505-T5 (5 foot); SD505-T10 (10 foot)	1700-09882
SD505-DUCTR	Duct Detector housing with relay base. Duct housing with relay base including SD505-APS Analog Photoelectric Smoke detector pre-installed	1700-09882
SD505-ADH	Duct Detector Housing for use with the SD505-AIS or SD505-APS smoke detectors. Intake tubing for duct available in three lengths: STS-2.5: Duct widths 1.0' to 2.5'; STS-5.0: Duct widths 2.5' to 5.0'; STS-10.0: Duct widths 5.0' to 10.0' When ordering SD505-ADH, specify intake tubing size and order the appropriate smoke detector (if needed).	151040
SD505-ADHR	Duct detector housing with relay (for use with SD505-AIS or SD505-APS smoke detectors)	151126
SD500-PS/-PSDA	Single or dual action addressable pull station	151177
SD500-AIM	Addressable input module (switch input), standard size, dipswitch configurable	151071
SD500-MIM	Mini input monitor module (switch input), small size, dipswitch configurable. Fits in single-gang box with manual pull station switch.	151071
SD500-ANM	Addressable notification module	151109
SD500ARM	Addressable relay module dipswitch configurable.	151091
SD500-SDM	Addressable smoke detector module. Use to assign an address to a loop of conventional devices.	151193
SD500-LIM	Line isolator module. Fits in a double gang box.	151125
SD500-LED	Addressable LED driver module. Capable of driving up to 80 LEDs. Up to 40 SD500-LED Driver Modules can be used per SLC loop.	151232
SD505-DTS, SD505-DTS-K	Remote test switch & LED indicator for the SD505-ADHR and SD505-DUCTR	151126

5.3 Maximum Number of Devices

The 5820XL supports SK or Hochiki devices on one 5820XL system. The maximum number of devices per system varies depending on device protocol and the number of 5815XL signaling circuit loop (SLC) expanders added to the system. Device support is as follows:

- **SK Devices**—A 5820XL system can support a total of 396 SK detectors *and* 396 SK modules. 99 detectors and 99 modules can be connected to the built-in SLC loop. Each optional 5815XL adds another 99 detectors and 99 modules. Add up to three 5815XLs to a system to achieve the maximum number of devices on the system.

OR

- **Hochiki Devices**—A 5820XL system can support a total of 508 Hochiki SLC detectors and modules, in any combination. 127 devices can be connected to the built-in SLC loop. Each optional 5815XL adds another 127 devices.

5.4 Wiring Requirements for SLC Devices

The following information applies to all SLC devices. Refer to the section that describes the type of device you are installing for details.

5.4.1 Wiring 5815XL in Style 4 (Class B) Configuration

No special wire is required for addressable loops. The wire can be untwisted, unshielded, solid or stranded as long as it meets the National Electric Code 760-51 requirements for power limited fire protective signaling cables. Wire distances are computed using copper wire.

Maximum wiring resistance is 40 ohms for SK devices and 50 ohms for Hochiki devices.

Maximum loop length depends on the wire gauge. See Table 5-1 for SK and Table 5-2 for Hochiki.

Table 5-1 Maximum wiring distance for SK modules

Wire Gauge	MAX. Distance for SK
22 AWG	1200 feet
18 AWG	3100 feet
16 AWG	4900 feet
14 AWG	7900 feet
12 AWG	10,000 feet

Table 5-2 Maximum wiring distance for Hochiki devices

Wire Gauge	Max. Distance for Hochiki
22 AWG	1500 feet
18 AWG	3900 feet
16 AWG	6200 feet
14 AWG	10,000 feet

Figure 5-1 and Figure 5-2 show how wire length is determined for out-and-back tap and T-tap style wiring.

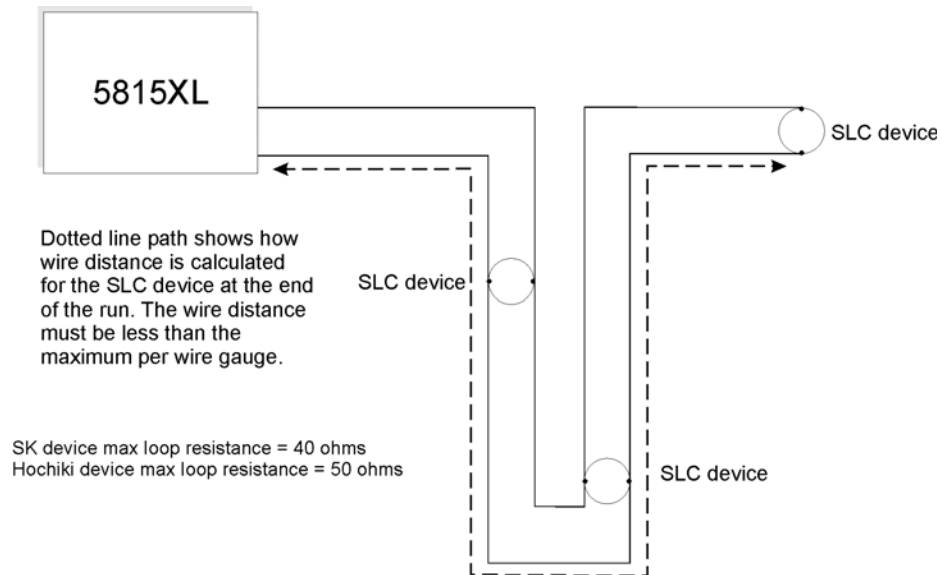

Figure 5-1 Calculating wire run length for a simple out and back tap

When using T-taps, the total length of all taps and the main bus must not exceed 40,000 feet. This requirement must be met in addition to the maximum distance requirements for the various wire gauges.

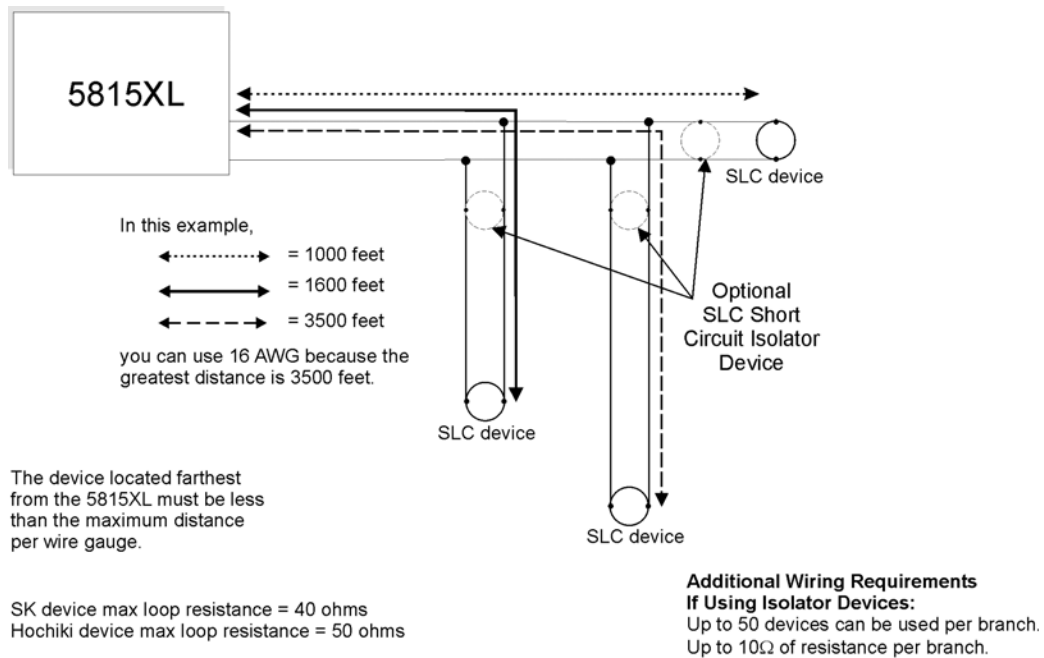

Figure 5-2 Calculating Wire Run Length for a T-tap

5.4.2 Wiring 5815XL in Style 6 & 7 (Class A) Configuration

Figure 5-3 illustrates how to wire the SLC loop for Style 6 or Style 7 Class A installations.

Note: Style 6 does not use short circuit isolator devices.

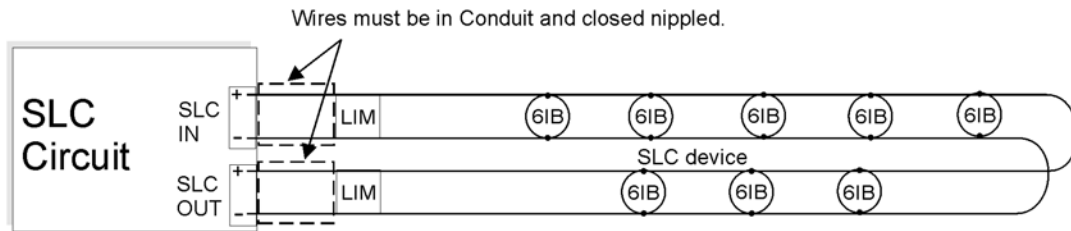
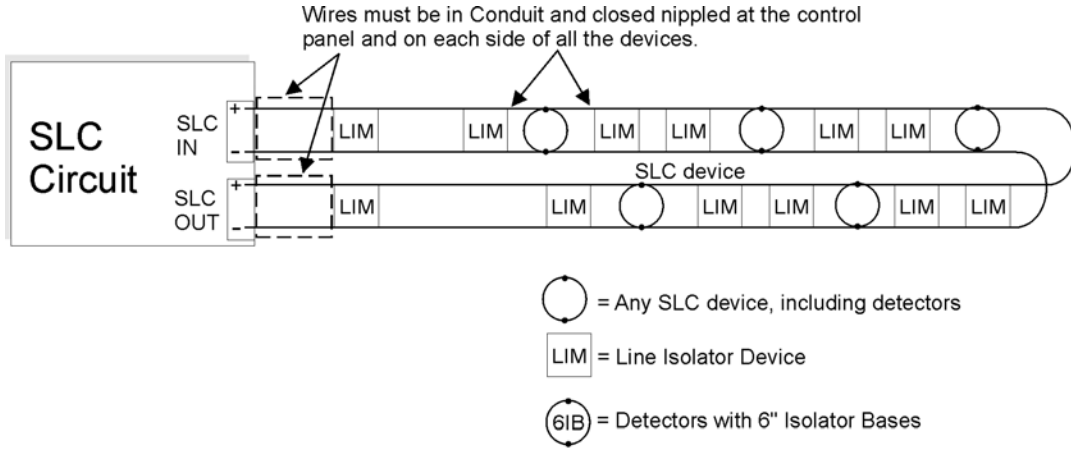

Figure 5-3 Class A SLC Configuration

Note: No t-taps allowed on class A SLC loops.

Caution

For proper system supervision do not use looped wire under terminals marked SLC + and - of the SLC device connectors. Break wire runs to provide supervision of connections.

5.5 Wiring SK SLC Detectors

This section describes how to install SK heat and smoke detectors. All detectors ship with installation instructions. Refer to the detector's installation instructions for more detailed information.

This information applies to the following SK models:

- SK-Photo Photoelectric Smoke Detector
- SK-Photo-T Photoelectric Smoke Detector with Thermal
- SK-Acclimate Photoelectric Smoke Detector with Thermal
- SK-Heat Fixed Temperature Detector
- SK-Heat-T High Temperature Thermal Detector
- SK-Heat-ROR Rate-of-Rise Thermal Detector
- SK-Ion Ionization Smoke Detector

To wire SK detectors:

1. Wire device bases as shown in Figure 5-4.
2. Set the address for each device as described in Section 5.6.

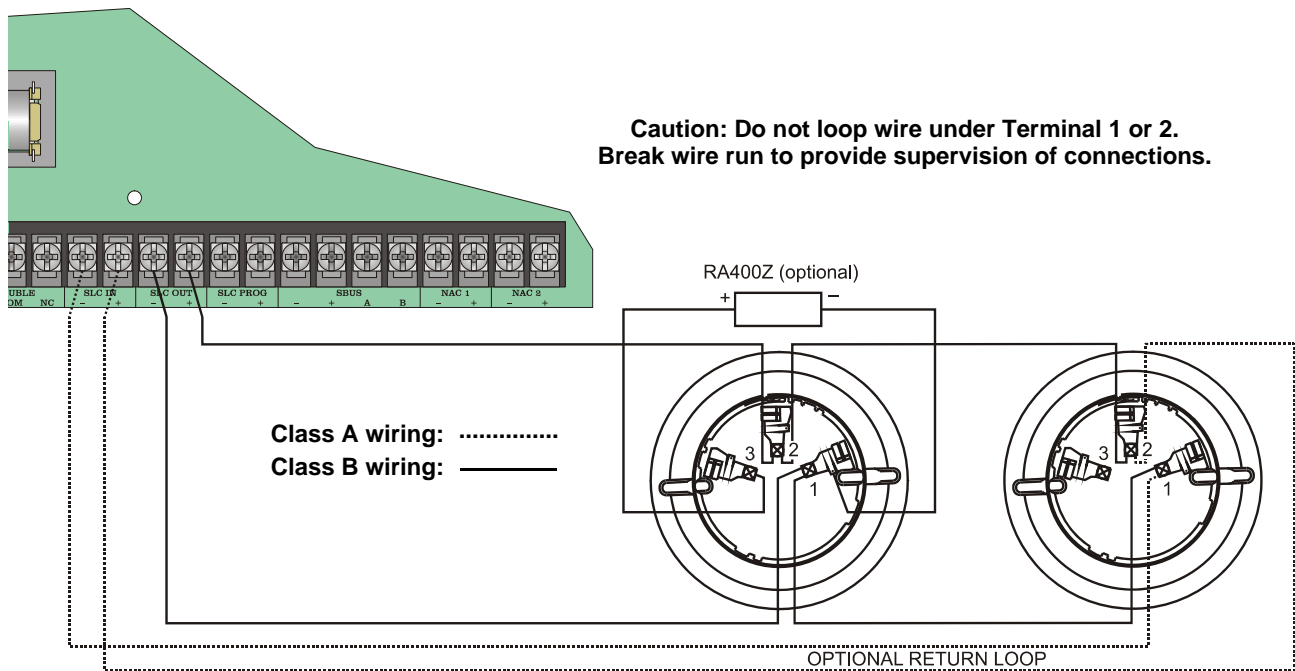

Figure 5-4 Heat and Smoke Detector Connection to the Panel.

5.6 Addressing SK SLC Devices

All SK devices are addressed using the two rotary dials that appear on the device board. Use the *ONES* rotary dial to set the ones place in a one or two digit number, and use the *TENS* rotary dial to set the tens place in a two digit number.

SK device addresses are handled differently than Hochiki device addresses. The control panel recognizes when an SK detector or SK module is installed. For this reason, SK detectors can be assigned any unique address from 1 to 99, and SK modules can be assigned any unique address from 1 to 99. Unlike Hochiki detectors and modules which share addresses 1 through 99, there can be an SK detector using address 1 and an SK module using address 1. 0 is an invalid address.

Example 1: To select device address 1, turn the *ONES* rotary dial to **1** and the *TENS* rotary dial to **0** as shown in Figure 5-5.

Example 2: To select device address 42, turn the *ONES* rotary dial to **2** and the *TENS* rotary dial to **4** as show in Figure 5-5.

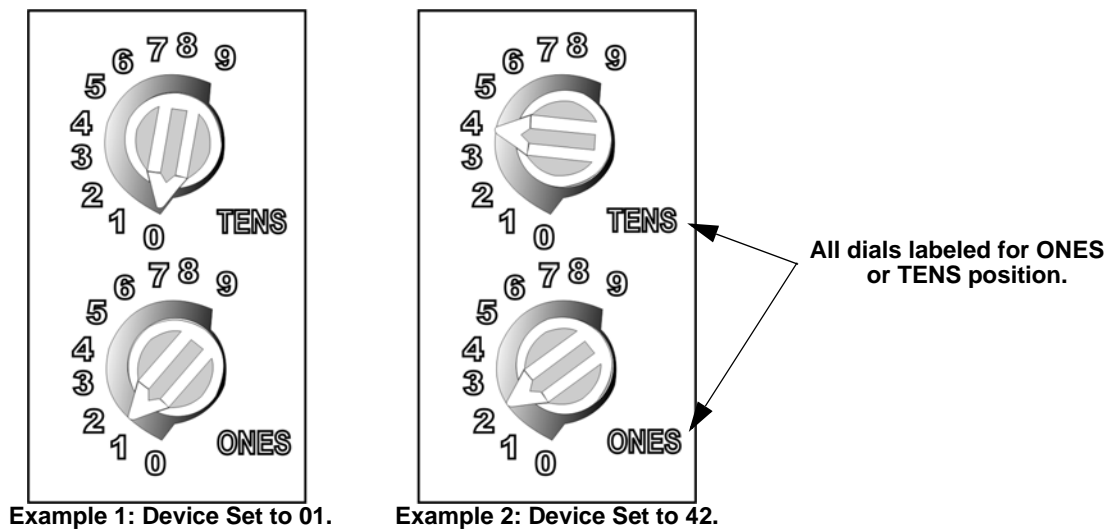

Figure 5-5 SK SLC Device Addressing Using Rotary Dials

5.7 Hochiki Detector Installation

The information in this section applies to the following Hochiki models: SD505-AHS Heat Detector, SD505-AIS Ionization Smoke Detector, and SD505-APS Photoelectric Smoke Detector.

Also see Section 5.8 for information on how to address the detectors.

5.7.1 Wiring Hochiki Detectors

1. Wire device bases as shown in Figure 5-6.
2. Set the address for each device as described in Section 5.8.
3. If you are connecting to the main panel, do not connect any devices to terminals 35 and 36. If you are connecting to the 5815XL, do not connect any devices to "SLC IN".

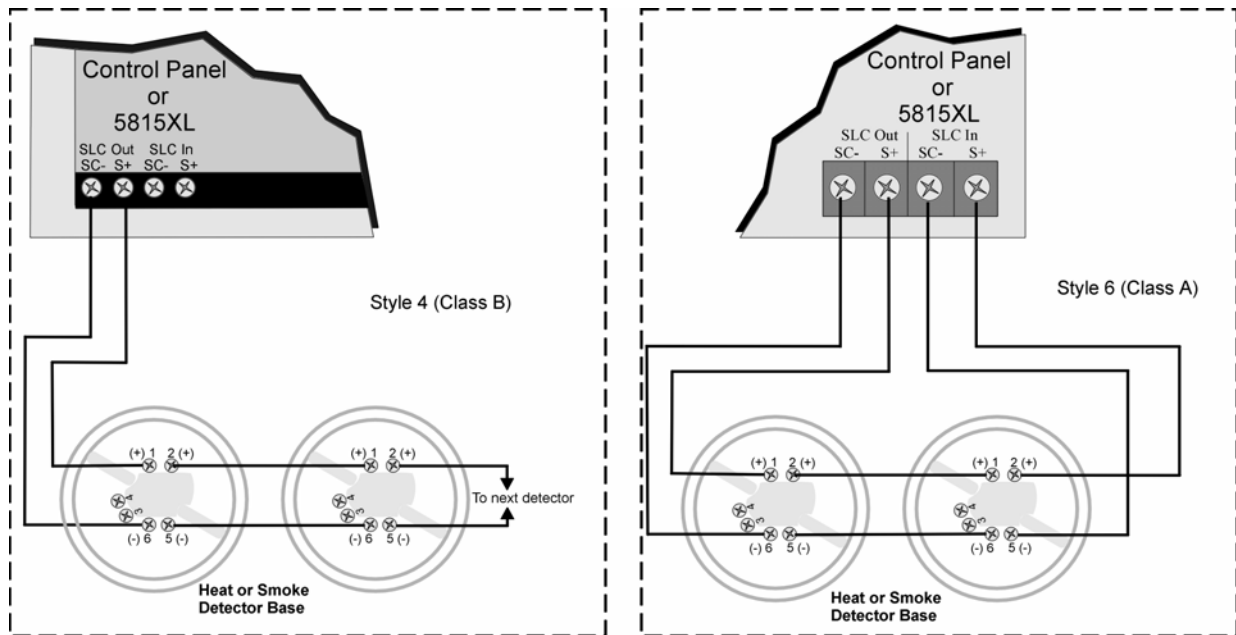

Figure 5-6 Heat or Smoke Detector Connection to the FACP (Class B)

5.8 Addressing Hochiki Devices

This section tells how to address detectors and modules.

5.8.1 SD505-APS, SD505-AHS, & SD505-AIS

The SD505-APS photoelectric smoke detector, SD505-AHS heat detector, and SD505-AIS ionization smoke detector are easily addressed at the FACP. The Installer Code is required to perform this task.

To address a SD505-APS, SD505-AHS, or SD505-AIS:

1. Connect a detector base temporarily to the programming terminals as shown in Figure 5-7. (You can use the same base for each detector.)

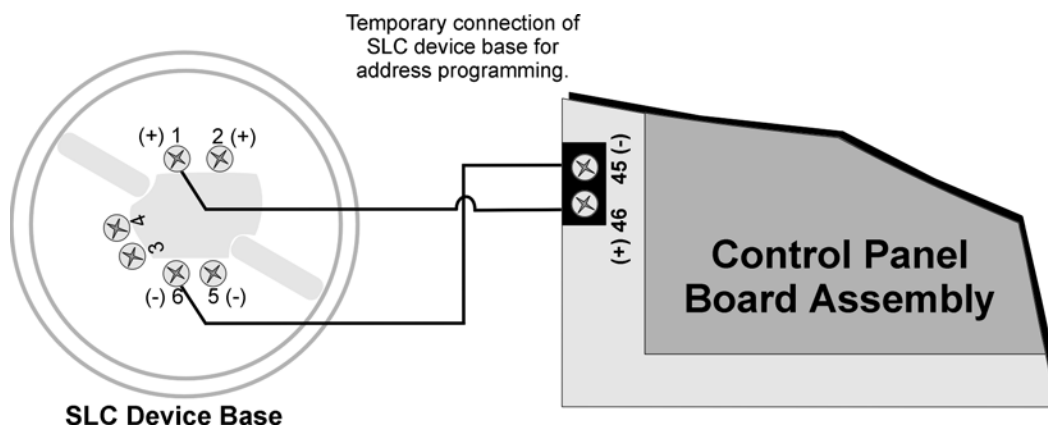

Figure 5-7 Temporary Connection of Detector Base to Panel for Addressing

2. Enter the Installer code, then press **ENTER**.
3. Select **2** for Point Functions.
4. Select **3** for Set SLC Dev Addr.
5. Select “Yes” by pressing the **▲** up arrow, then press **ENTER**. (The panel will go into trouble at this point. You can use the **SILENCE** key to stop the PZT. The trouble will clear automatically when the panel re initializes when you finish programming.)
6. When the wait message clears, the following options display:
 - 1** for Read Address. Use to read (or check) a single detector’s address.
 - 2** for Write Address. Use to program a single detector’s address.
 - 3** for Seq. Programming. Use to program more than one detector in sequential order.
7. If you are changing addresses, write the programmed address on the back of the device.
8. To exit press **◀** left arrow until fully exited.

Section 6

Programming Overview

This section of the manual is intended to give you an overview of the programming process. Please read this section of the manual carefully, especially if you are programming the control panel for the first time.

The JumpStart feature automates many programming tasks and selects default options for the system. You will run JumpStart at least once when you are installing the system. See Section 6.1 for details. After you run JumpStart, you may need to do some additional programming depending on your installation. Section 7 of this manual covers manual programmable options in detail.

Programming the panel can be thought of as a three part process. You must program:

- System options. These are options that affect general operation of the panel (see Section 7.7 for details).
- Options for input points and zones. These are primarily options that control detection behavior of devices (see Section 7.6 for details).
- Options for output points and groups. This includes selecting characteristics for output groups and mapping output circuits to output groups (see Section 7.6 for details).

6.1 JumpStart Autoprogramming

The JumpStart feature allows for faster system setup. When you run JumpStart (immediately after addressing SLC devices), the system scans devices on all SLC loops and determines device type (for example, ionization smoke detector or heat sensor) and selects some system options based on the device type. This saves the installer from having to program options for each device. Depending on the application, the installer may need to make some changes after JumpStart completes.

See Section 6.1.3 for complete details about running JumpStart.

IMPORTANT

JumpStart is intended to be run one time only, immediately after SLC devices have been addressed and connected. JumpStart will reset all manually programmed options to default settings. Do not run JumpStart after you have configured the system.

6.1.1 Input Points

JumpStart will determine the number and type of input points (detectors or contact monitor modules) on each SLC loop. JumpStart assigns the correct detector type (heat, ionization or photoelectric), so the installer does not need to edit device type for detectors. Any contact monitor modules on the system will be assigned type "Manual Pull." The installer will need to manually change the switch type if manual pull is not correct.

JumpStart creates one zone (Zone 1) and assigns all input points to Zone 1. Zone 1 is mapped to Output Group 1. After JumpStart completes, you can re-map to configure a multiple zone/output group system (see Section 7.4.1.3). For a general explanation of mapping, see Section 6.2.

6.1.2 Output Points

JumpStart creates three output groups and assigns output circuits as follows:

Circuits 1-6:

Configured as Notification and assigned to Group 1. JumpStart automatically programs Zone 1 to activate Group 1 using constant on output.

Circuit 7 (Relay 1):

Assigned to Group 249. JumpStart automatically programs Zone 1 to activate Group 249 using constant on output when a supervisory condition occurs.

Circuit 8 (Relay 2):

Assigned to Group 250. JumpStart automatically programs Zone 1 to activate Group 250 using constant on output when an alarm occurs.

Addressable output points (Relay modules, NAC Modules, Sounder Bases, Relay Bases):

All addressable relay devices will be configured as "Output Pt" (general purpose output point) and assigned to Group 1.



Note: Relay output is constant even if the zone activating the relay is programmed with an output pattern.

6.1.3 Running JumpStart

Run JumpStart immediately after you have addressed and connected all input devices (detectors, pull stations, and so on) and output devices (notification appliances, relays, and so on).

Note: If you need to install a few devices after you have run JumpStart, you can install them manually. Follow instructions in Section 8 for configuration.

To run JumpStart, follow these steps.

1. Press  to view Main Menu.
2. Select  for Program Menu.

3. From the next menu, select **[6]** for JumpStart.
4. The message "WARNING Will DELETE all system options" displays on the LCD. Select Yes to continue. A series of messages displays for the next several seconds. JumpStart scans the SLC loops for devices. This can take several minutes, depending on the number of devices attached.
5. When the message, "SLC FAMILY HOCHIKI" flashes. Press **ENTER** to accept Hochiki if installing, or press **▲** to display SK and press **ENTER** to accept SK.
6. When the message "Configuring System Done" displays, press any key to continue.
7. Select one of the following options from the menu that displays.

[1] - Review System	Press [1] if you need to review the JumpStart configuration.
[2] - Repeat JumpStart	Press [2] if you need to rerun JumpStart for any reason.
[3] - Accept Configuration	<ol style="list-style-type: none"> 1. If you are ready to make the JumpStart configuration permanent, select [3]. 2. The system will ask you if the installation contains duct detectors. If there are none, select [2] for No and skip to Step 8. If the system contains duct detectors, select [1] for Yes and continue with Step 3. 3. From the list that displays, select the 5815XL device that contains the duct detectors. 4. The first photoelectric or ionization detector on the system will display. Select [1] for DUCT and [2] for NonDUCT. 5. Press ▲ to select the next detector. Select [1] for DUCT and [2] for Non-DUCT. Continue until all duct detectors have been selected. (Note: You can move backwards through the list with ▼.) 6. When you reach the last detector on this device, press ◀. 7. The system will ask you if there are more duct detectors in the system. If there are, select [1] for Yes and repeat from Step 3. If there are no more duct detectors, select [2] for No and continue with Step 8. 8. The system will restart in 10 seconds. You can press [1] to restart immediately. Do not select [2] for System Diagnostics. (This feature is for use in testing at the factory.) 9. After the system resets, it will use the new JumpStart configuration.
[4] - Enter Programming	If you want to go directly to Program Mode to configure any devices, press [4] . The Programming Menu appears and you can begin programming.

6.2 Mapping Overview

This section of the manual is an overview of mapping. Details about how to select mapping options appear in the appropriate subsections in Section 7.

Mapping is an important concept with the control panel. In general terms, mapping is assigning or linking events to outputs that should activate when events occur. You do this by assigning input points to input zones, output points to output groups and then linking or mapping zones and output groups.

Figure 6-1 is a brief overview of the concept of mapping. The next several pages of the manual show these subjects in detail.

In its simplest application, mapping is determining which outputs are activated by which inputs.

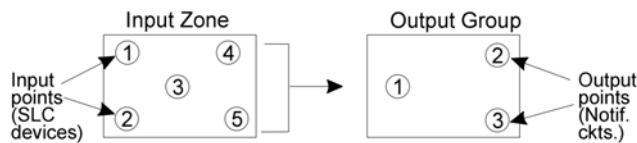

Because the Control Panel programming is so flexible, there are a number of uses for mapping, as shown in the diagram below.

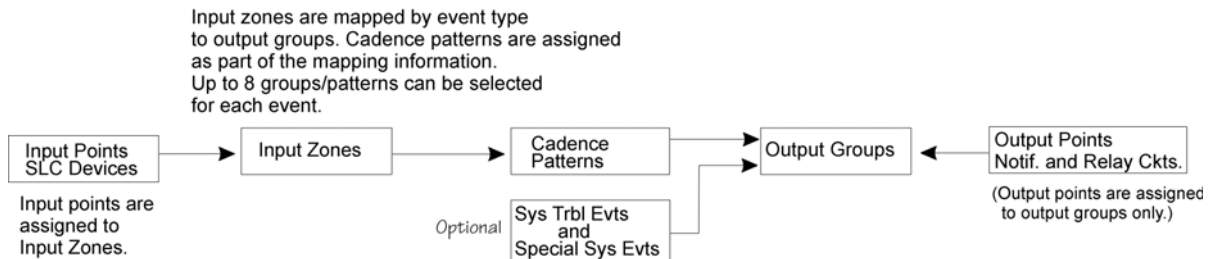

Figure 6-1 Mapping Overview

6.2.1 Input Point Mapping

Input points are assigned to input zones. Any input point can be assigned to any input zone. (Input points can be assigned to one zone only. An input point can be designated as “Unused,” which means it has not been assigned to a zone.)

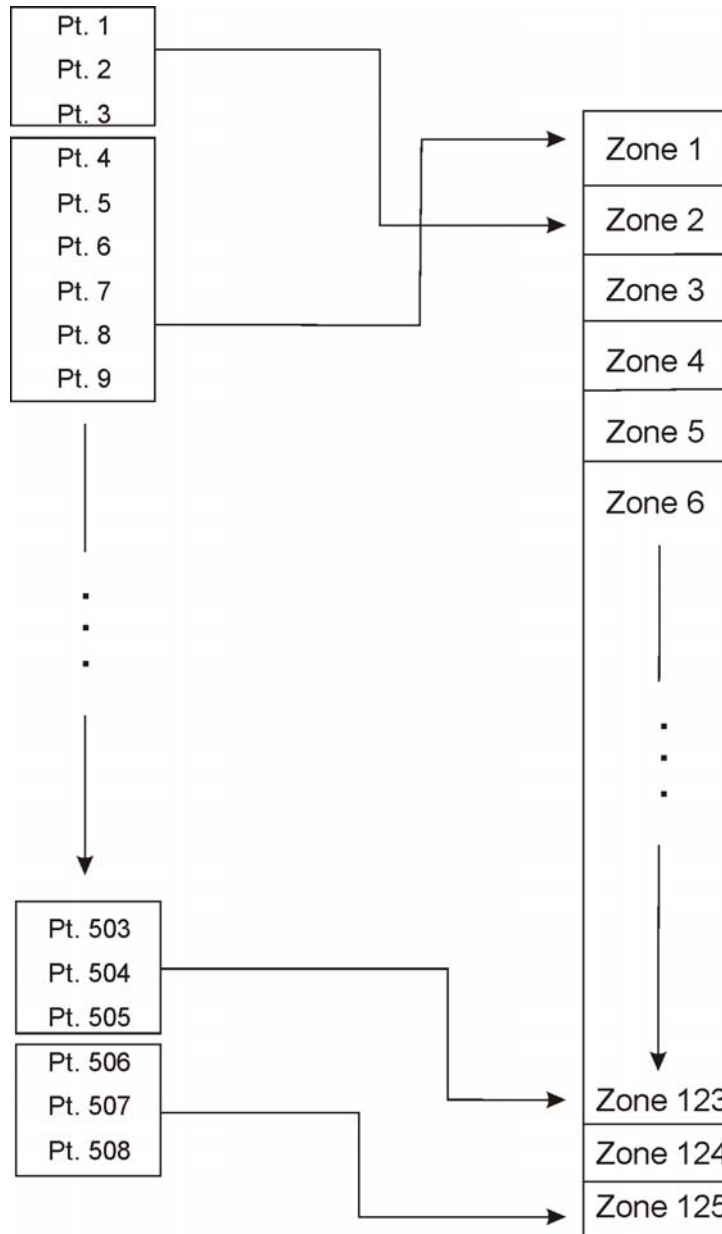

Figure 6-2 Input Point Assignment Example

6.2.2 Output Circuit Mapping

Figure 6-3 is a simple example showing how to assign notification and relay output circuits to groups. For an example of a simple floor above/floor below application, see Figure 6-5.

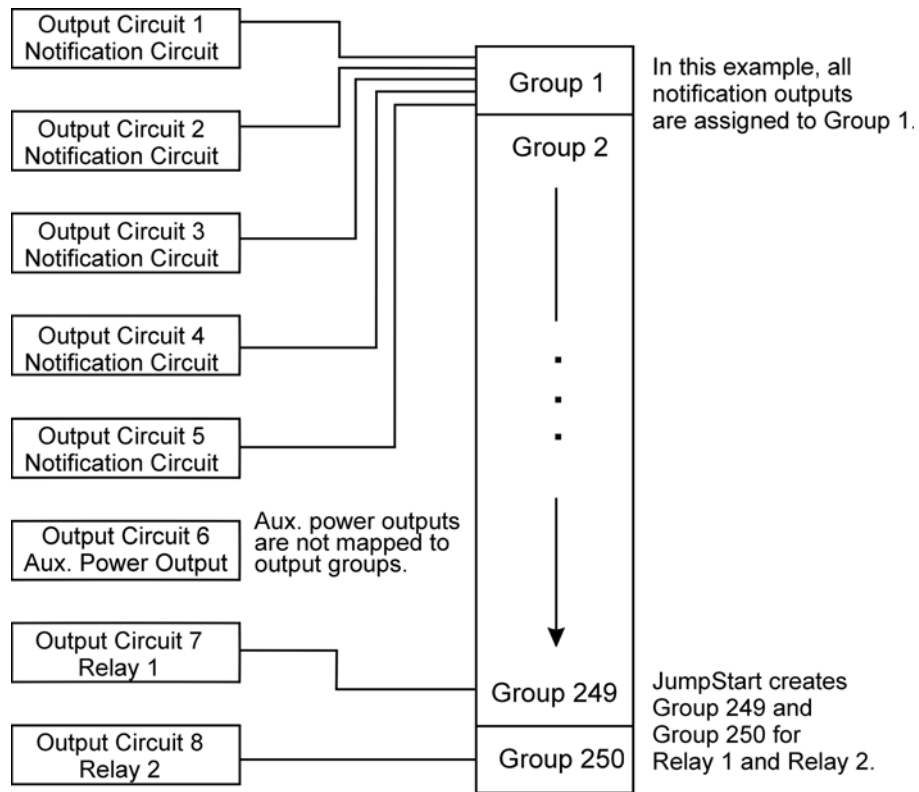

Figure 6-3 Assigning Output Circuits to Groups (Example)

6.2.3 Zone Event Mapping

There are 8 types of events that can occur in zones (see below). For each event type, you can activate up to 8 output groups and patterns. If it is necessary to map to more than 8 output groups, an output group template may be used (see Section 7.5.5 for information on output group templates). Event types are:

- Manual Pull Alarm
- Water Flow Alarm
- Detector Alarm (heat or smoke detectors)
- Aux 1 and Aux 2 Alarm (user-specified alarm types)
- Pre-alarm
- Supervisory
- Trouble

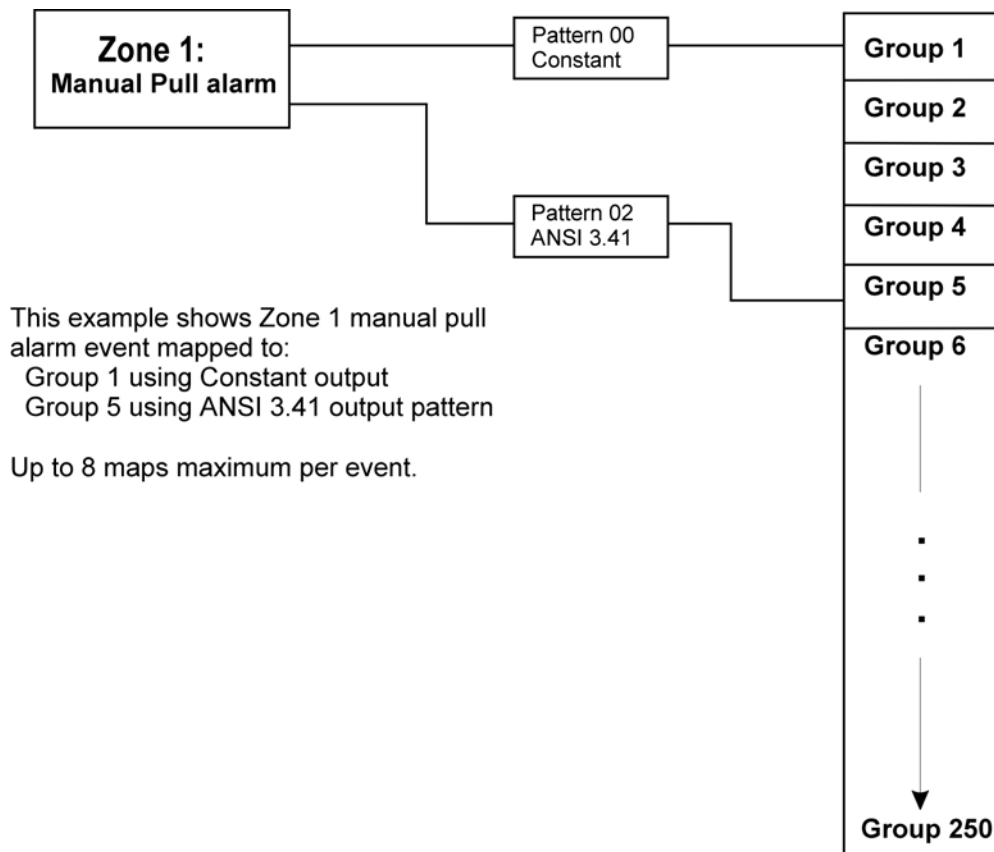

Figure 6-4 Example of Zone Events Mapped to Output Groups and Patterns

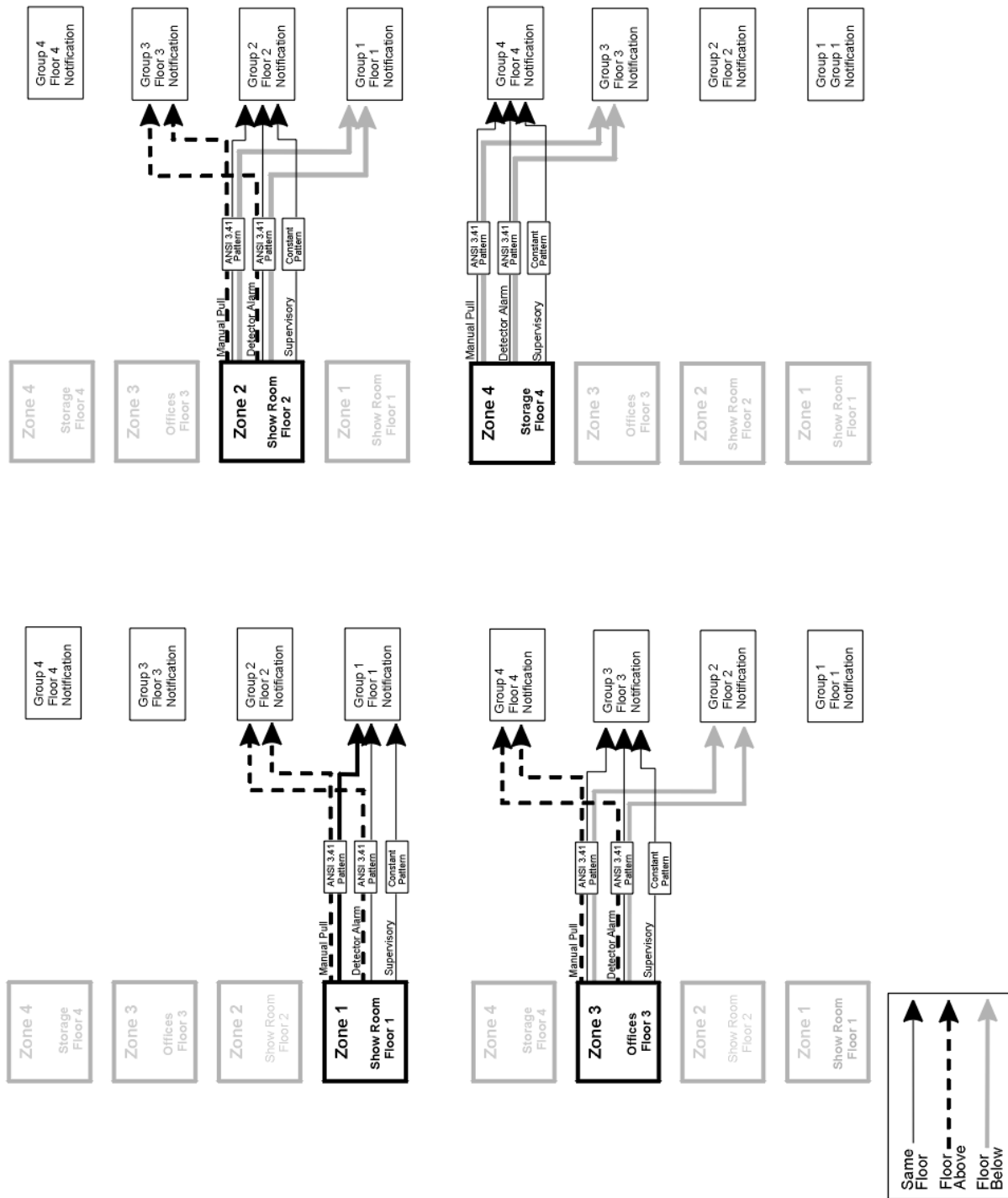

Figure 6-5 Example of Zone Events Mapped to Output Groups and Patterns

6.2.4 Mapping LED Points

Figure 6-6 is a simple example showing how LED points are mapped to zones and output groups. Typically you would create two output groups for each zone, one for alarms and one for troubles. (LED points are available when Models 5865-3/4 and/or 5880 are used with the system.)

Mapping LEDs to Zones and Output Groups

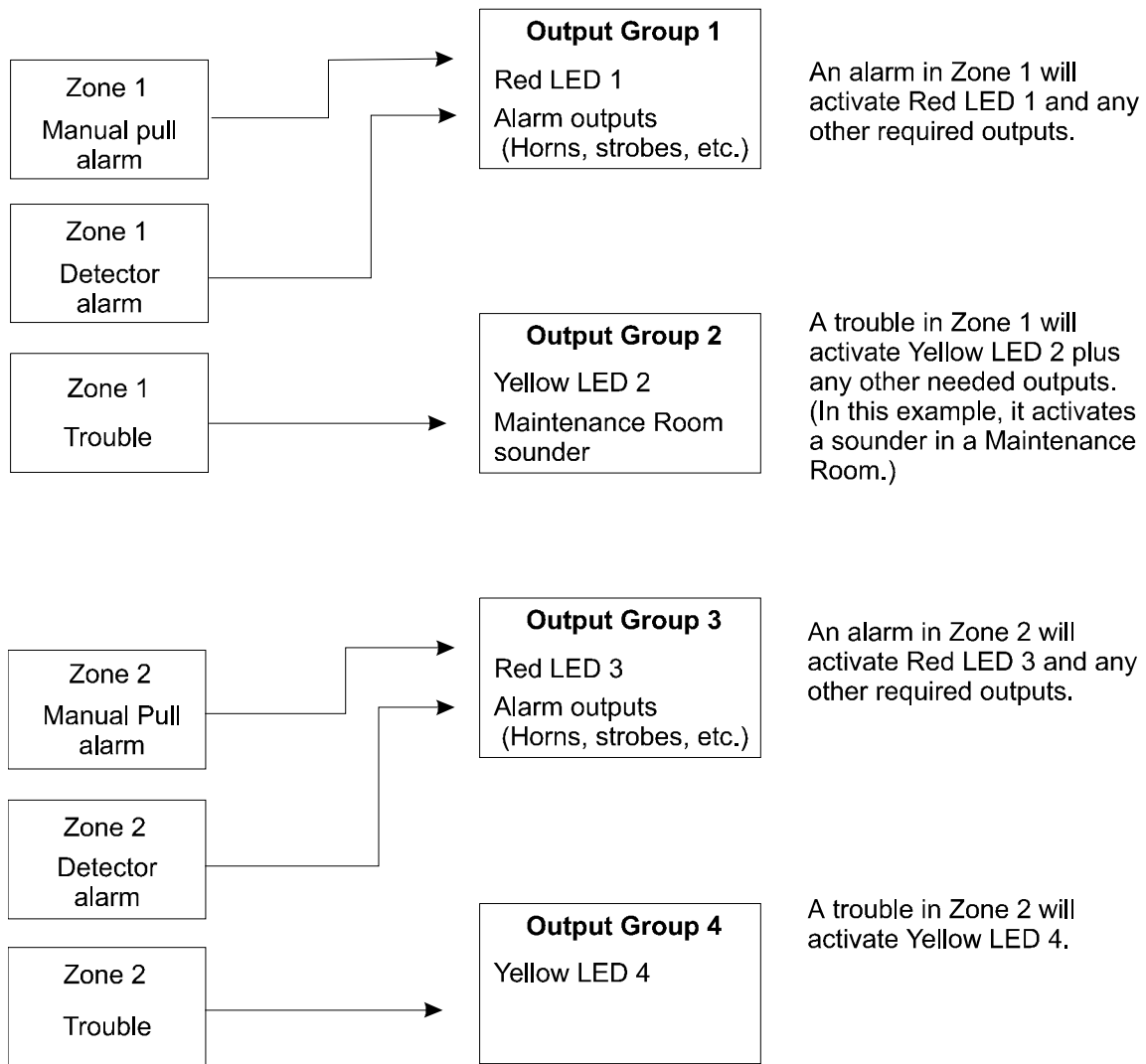

Figure 6-6 Example of LED Points Mapped to Output Groups (applies to Models 5865-3/4 and 5880)

6.3 Programming Using the 5660 Silent Knight Software Suite

You can use the 5660 Silent Knight Software Suite (SKSS) to program the control panel onsite or remotely. SKSS is an optional software package that lets you easily program the control panel using a Windows-based computer and a modem* (not sold by Silent Knight). When using SKSS, you can set up the programming options for the panel, save the options in a file, then download the file to the panel. You connect to the control panel directly using the control panel's onboard USB or serial port or remotely using a modem. If you need to connect to an older control panel that does not have a USB port, and your laptop does not have a serial port, use a USB to serial converter. SKSS includes an online help system and a manual. See the SKSS manual (PN 151240) for more information.

* See Section 1.3 for a list of modems that have been tested for compatibility with the control panel and SKSS.



6.4 Programming Using an Annunciator

You can program the control panel from a system annunciator, using either the control panel's on-board annunciator or a Model 5860 Remote Annunciator.

The following subsections describe programming basics, including a description of editing keys available for programming and how to move through programming menus. Section 7 contains specific information about individual programming options.

6.4.1 Entering & Exiting the Program Menu

To enter Program Mode:

1. Enter the Installer Code (factory programmed default code is 5820).
2. The display prompts you to press the  or  key to bring up the Main Menu (see Figure 6-7).

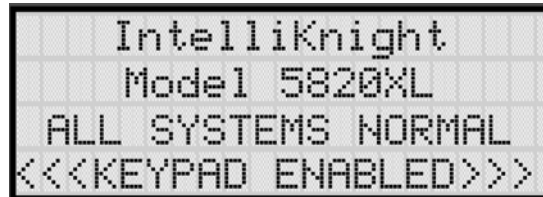



Figure 6-7 Keypad Enabled Screen

3. Then press . The menu option displays. See Section 7 for detailed menu information and Section 6.5 for a quick reference listing all programmable options and JumpStart defaults.

To exit Program Mode:

When you have completed working with the menus, press  (left arrow) several times until you are exited from programming mode. Two prompts will display. The first prompt is to make sure you intended to leave the Program Menu (select Yes or No as appropriate). The second prompt is for accepting all changes. If you select No, any changes you have made since you entered the Program Menu will have no effect.

6.4.1.1 Moving through the Menus

Figure 6-8 shows how to move through Program Menu screens, using the System Options screen as an example.

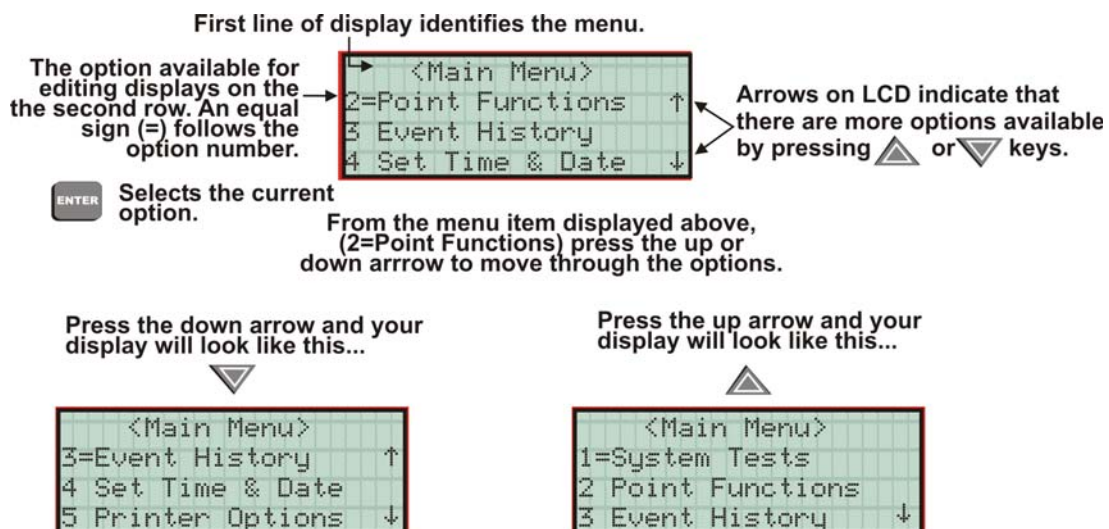





Figure 6-8 Moving through Program Menu (System Options Sub-Menu Used as an Example)

6.4.1.2 Selecting Options and Entering Data

There are several ways to make programming selections using the control panel depending on which screen you are currently using. The chart below is a generic explanation.



To	Press
Select from a menu.	Enter the number of the option.
Enter numeric data.	Press the appropriate number on the annunciator.
Enter text (alphanumeric data).	Enter each letter individually by pressing and holding any numeric key until the one you wish to select displays. Then press  (right arrow) to select the letter. See Section 6.4 for complete information.
Select from a scrolling list.	Use  (up arrow) and  (down arrow) to move through a list of available options. When the option you want to select is displayed, press  .

6.4.1.3 Editing Keys

The keys shown in Figure 6-9 are available for use when you are in the Program Menu.

Editing Keys

Up/down arrows Use to scroll through the available options within a field.

Left/right arrows Use to scroll through the fields on the screen.  (left arrow) backs out of a screen and returns you to a previous menu.

ENTER Accepts any changes (moves you to the next field).



1 2 3
(etc.) Enter numeric and textual data. To enter text, hold down the key until the letters begin displaying. Press  (right arrow) to select when the letter you want is displayed.

Figure 6-9 Editing Keys Available from Program Menu

6.5 Programming Menu Quick Reference

This section of the manual lists all Program Menu options in the order they appear on the sub-menu. Default settings are indicated in text or marked with an asterisk. The comments column provide quick information and a reference to a section (if applicable) which has more detailed information.

Menu	Options/Defaults				Comments	
SLC Family	Hochiki				Section 7.2	
	SK					
Module	Edit Module	Select Module	Enter Module Name	Select Class	Section 7.3.1	
	Add Module	5815XL-SLC				See Section 7.3.2
		5860-Keystation				
		5824-Ser/Par/IO				
		5895XL-io/Pwr Sup				
		5496 NAC Expand				
		5880-LED/IO Dev				
5865-LED Annunc						
Delete Module	List of Modules				Section 7.3.3	
View Module List	List of Modules					
Zone	Edit Zone	Select Zone to Edit	Edit Zone Name	Enter Name1	Section 7.4.1.1	
				Enter Number1		
				Enter Name2		
				Enter Number2		
			Zone Properties	Verification Type	*1 Count	Section 7.4.1.2
					2 Count	
					Alarm Ver.	
					PAS	
					SNGL ILOCK	
					DBL ILOCK	
			Heat Temp Set	135° to 150°F	Section 7.4.1.2	
			Zone Outputs	Manual Pull (MP)	(Groups 01 & 250, Pattern 00)	Section 7.4.1.3
				Water Flow (WF)		
				Detector Alarm		
				Aux 1	no group	
Aux 2						
Pre-alarm (PRE)						
Supervisory (SUP)	(Group 249, Pattern 00)					
Trouble (TRB)	no group					
Zone Accessory Opt	Cadence	00-20	Section 7.4.1.5			
	Local Zone	Yes or No				
Add Zone	Adds next available zone number.				Section 7.4.2	
Delete Zone	Select Zone to be Deleted				Section 7.4.3	
View Zone Points	List of all points in selected zone.				Section 7.4.4	

Menu	Options/Defaults				Comments	
Group ¹	Edit Group	Select Group	Group Name	Enter Name1		Section 7.5.1.1
				Enter Number1		
				Enter Name2		
				Enter Number2		
			Group Properties	Latching Options	*Non-Latching	Section 7.5.1.2
					Latching	
				Silencing Options	*SILENCE	Silenceable Section 7.5.1.2
					NON-SIL	Non-Silenceable Section 7.5.1.2
					Auto Unsilence	Auto Un-silenced Section 7.5.1.2
					SIL-INHIB	Silence after inhib delay. Section 7.5.1.2
					SHUT-DOWN	Automatic Shutdown Section 7.5.1.2
					Group Active With:	Group Activates for all Man. Pull
				Group Activates for Fire Drill		*Yes. Section 7.5.1.2
				Group Activates for Aux 1		*No. Section 7.5.1.2
				Group Activates for Aux 2		*No. Section 7.5.1.2
				Ignore Global Cadence		*No. Section 7.5.1.2
	Add Group					Section 7.5.2
	Delete Group	Select Group to Delete				Section 7.5.3
	View Group Points	Select Group				Section 7.5.4
	Edit OPG Template	Select Template Number	Select Group			Section 7.5.5
Include in template			Yes			
			No			
Select Pattern	0-16	0 = Constant.	Section 7.4.1.4			

Menu	Options/Defaults			Comments			
Point	Internal and External 5815XL	Enter Pt	UNUSED				
			DETECTOR	PHOTO	Select Latching	Section 7.6	
				ION			
				HEAT			
				PHOT DUCT			
				ION DUCT			
				2WIRE SMK			
			SUP DET	SUP PHOTO	Select Latching		
				SUP ION			
			SWITCH	MAN_PULL		Section 7.6	
				WATERFLOW	LATCH		
					NLATCH		
				SUPERVSY	LATCH		
					NLATCH		
				FIREDRILL			
				SILENCE			
				RESET			
				PAS_ACK			
				ZN_AUX1	LATCH		
					NLATCH		
				ZN_AUX2	LATCH		
					NLATCH		
				SYS_AUX1	LATCH		
					NLATCH		
			SYS_AUX2	LATCH			
				NLATCH			
			DETECT SW				
			TAMPER	LATCH			
NLATCH							
MAN REL							
ILOCK							
NOTIF	OUTPUT PT	Select Group	Section 7.6				
	AUX CONST						
	AUX RESET						
	AUX DOOR						
RELAY	OUTPUT PT	Select Group	Section 7.6				
	AUX RESET						
	AUX DOOR						
SLC LED	LED No. 01 - 80	Select Group	Section 7.6				

Menu	Options/Defaults				Comments		
Point (cont.)	Internal Pwr and External Power	Enter Pt	Input Point Type (detector/switch)	Select Function	Per JumpStart		
		Select Type	UNUSED			Section 7.6	
			B NOTIF	Select Group			
			A NOTIF				
			AUX PWR	CONSTANT			
				RESETABLE			
				DOOR			
		B SWITCH	MAN PULL	Select zone	Latch and Non-latch feature only appear for waterfowl, supervisory, tamper, zone aux1, zone aux2, system aux1, and system aux2. Section 7.6.		
			WATERFLOW	Select zone			
			SUPERVSY	Select zone			
			TAMPER	Select zone			
			DETECT SW				
			FIREDRILL				
			SILENCE				
			RESET				
			PAS_ACK	Select zone			
			ZN_AUX1	Select zone			
			ZN_AUX2	Select zone			
			SYS_AUX1				
			SYS_AUX2				
			MAN REL			Section 7.6	
		ILOCK					
		A SWITCH	Same as B SWITCH		Section 7.6		
		B DETECTOR	2-WIRE SMK				
4-WIRE SMK							
A DETECTOR	2-WIRE SMK						
	4-WIRE SMK						
Select Group or Zone Number				Group or Zone selection will appear depending on the type selected. Section 7.6			
	Edit Name	Enter Name		Section 7.6.3			
5880	Enter Point #	NOTIF					
		UNUSED					
	Select Group #						
	Edit Name	Enter Name					
5865	Enter Point #	NOTIF		Section 7.6.3			
		UNUSED					
	Select Group #						
	Edit Name	Enter Name					

Menu	Options/Defaults			Comments		
System Options	Reporting Accounts	Edit Acct.	For each account (1-4), select:			
			Edit Account #		*123456	Account # (6-digit number, identifies account to central station) Section 7.7.1
			Edit Format		*Contact ID	Reporting Format (SIA, S20, Contact ID) Section 7.7.1
			Report Alarms	Y (Yes)	*Yes	Section 7.7.1
				N (No)		
				M (Must)		
			Rep. Alarm Restore	Y (Yes)	*No	
				N (No)		
				M (Must)		
			Report Troubles	Y (Yes)		
				N (No)		
				M (Must)		
			Report Ena/Disable	Y (Yes)		
		N (No)				
		M (Must)				
		Report Test	Y (Yes)			
			N (No)			
			M (Must)			
		Report Resets	Y (Yes)			
			N (No)			
M (Must)						
Switch attempts	1 - 5	*5	Section 7.7.1			
Fail attempts	1 - 15	*10				
Primary Phone Line	1 or 2	*Line 1				
Secondary Phone Line	1 or 2	*Line 2				
Edit Phone #1	up to 40 digits	blank				
Auto Test Time	Set the Hour	*02:00 AM				
	Set the Minutes					
	Select AM/PM					

Menu	Options/Defaults			Comments		
System Options (cont.)	Phone Lines	Select Phone Line	For each phone line (1 & 2), select:			
			Dialing Prefix	Up to 9 digits	none	Section 7.7.2.1
			# of Answer Rings	Range: 00-15	06	Number of rings before panel answers a call from a computer Section 7.7.2.2
			Select Dialing Option	TT	TouchTone	Touch Tone
				TT/PL		TouchTone alternating with pulse see Section 7.7.2.3
				PULSE		Pulse dialing
			Rotary Pulse Format	U = 60/40	*U	Section 7.7.2.4
			E = 66/34			
			Line Monitor	Yes	*Yes	Section 7.7.2.5
				No		
			Ground Start	Yes = enabled	*N = Disabled	Section 7.7.2.6
	No = disabled					
	Answering Machine Bypass	Yes = enabled	*Y = Enabled	Section 7.7.2.7		
		No = disabled				
	System Event Outputs	Trouble Events	System Trouble	Select Group	None selected	Section 7.7.3.1
				Select Cadence		
			Alarm Silence	Select Group	None selected	
				Select Cadence		
			Trbl Silence	Select Group	None selected	
				Select Cadence		
			User Selected	Group Tr	Select Group	
				SBUS Com		
				SBUS Pwr		
		SLC Loop				
AC Loss						
Battery						
Gnd Flt		Select Cadence				
Phone Ln						
Account						
Printer						
Aux Pwr						
Sys Sw						
Sys Alarm Cadence	Fire Drill		Select Cadence	Constant	Section 7.7.3.2	
	System Aux1					
	System Aux2					

Menu	Options/Defaults				Comments
System Options (cont.)	Misc. Options 1	Water Flow Delay	0 - 90 Seconds	*30 sec	Water Flow delay is the number of sec. before water flow alarm is generated. Section 7.7.4.1
		Low AC Delay	0 - 30 hours	*3 hrs	Low AC Report Delay. Section 7.7.4.2
		DST	Y (Enabled)	*Enabled	Automatic Daylight Saving Time enable or disable. Section 7.7.4.3 and 7.7.6.3. See also DST settings in Misc. Option 3, below.
			N (Disabled)		
		CLK	AM/PM	*AM/PM	System Clock Format (AM/PM or military). Section 7.7.4.4
	MIL				
	AC Freq:	50 Hz		Section 7.7.4.5	
		60 Hz			
		Neither			
	Misc. Options 2	SYNC Strbs w/ Sil	Y (Enabled)	*Disabled	Section 7.7.5.1
			N (Disabled)		
		Auto Display Oldest	Y (Enabled)	*Disabled	Section 7.7.5.2
	N (Disabled)				
	Report By	Zone	*Zone	Section 7.7.5.3	
		Point			
	Misc. Options 3	Alarm Verification time	Enter time from 1 to 250 seconds	*60 Seconds	Section 7.7.6
		Plex Door	Y (Enabled)	*Disabled	
			N (Disabled)		
		DST Start	Select week: 1st, 2nd, 3rd, 4th or Last	Select month	Section 7.7.4.3 and 7.7.6.3. See also DST settings in Misc. Options 1, above.
	DST End				
Edit Banner	Internal Message			Section 7.7.7	
	Custom Message	Edit Line 1			
Edit Line 2					
JumpStart AutoPrg	No				Section 7.8
	Yes				
Computer Account	Computer Account #	*5820			Section 7.9
	Computer Access Code	*0			
	Computer Phone #	Up to 40 digits			

Menu	Options/Defaults		Comments
Access Codes	Select Profile (01 - 20)	Edit Name	<p>Profile 1 is the profile that dictates what functions the Firefighter Key has access to. Because this is the profile for a key the user name and the access code can not be edited for this profile.</p> <p>Profile 2 is the profile for the installer and is referred to as the "Installer Code". This profile's user name and panel functions can not be edited.</p> <p>See Section 7.10.</p>
		Edit Access Code	
		System Reset	
		System Silence	
		System Event Ack.	
		Fire Drill Key	
		System Tests	
		Fire Drill Menu	
		Indicator Test	
		Walk Test no-Report	
		Walk Test w/Report	
		Dialer Test	
		Clear History Buffer	
		Point Functions	
		Disable/Enable Point	
		Point Status	
		Set SLC Device Address	
		SLC Device Locator	
		SLC Multi-Device Locator	
		I/O Point Control	
		Event History	
		Set Time & Date	
		Printer Options	
		Event Logging	
		Print Event History	
		Print Detector Status	
		Print System Config	
Reset Dialer			
Program Menu			
System Information			
Upload/Download			

1. Use of multiple notification groups may not synchronize with each other.

Section 7

Programming

This section of the manual describes how to manually program the control panel from the built-in annunciator. Each subsection discusses these menu options in detail. All options described in this section can be performed using the 5660 Silent Knight Software Suite (SKSS).

Important!

Before any customized programming is done, JumpStart should be run first. After JumpStart is run, thoroughly test the system. The reason the system should be tested after JumpStart is because Jumpstart automatically programs the system, searching for and configuring all SLC and SBUS devices it finds. JumpStart allows you to confirm the integrity of the installation prior to performing any custom programming. After determining that the hardware is properly installed, custom programming can be performed. Refer to Section 6.



7.1 UL 864 Programming Requirements

NOTICE TO USERS, INSTALLERS, AUTHORITIES HAVING JURISDICTION, AND OTHER INVOLVED PARTIES: This product incorporates field programmable software. In order for the product to comply with the requirements in the Standard for Control Units and Accessories for Fire Alarm Systems, UL 864, certain programming features or options must be limited to specific values or not used at all as indicated below.



Programming Option	Menu Item	Permitted in UL 864 (Y/N)	Possible Settings	Settings Permitted in UL 864
Phone Lines	Enable Gnd Start	No	Yes & No	No
Misc Options 1	Low AC Report Delay	Yes	0–30 hours	1–3

7.2 SLC Family

The 5820XL supports Hochiki protocol SLC devices or SK series SLC devices. You must configure the 5820XL to accept the protocol of the devices you are installing. You cannot mix SLC devices of different protocols.

1. Press  or  to display the main menu.
2. Enter the installer code if requested.
3. Select  for Program Menu.

```
Display reads:      Initializing
                  Please wait . . .
```

4. Press  to enter module menu.
5. Press  to select the desired SLC device type.
6. Press  to accept the displayed SLC device type.

7.3 Modules

This section lists the options available under the module option in the program menu. The following modules are available for the control panel: 5815XL SLC expander, 5860 remote fire alarm annunciator, 5824 serial/parallel printer interface module, 5496 intelligent power module, 5895XL intelligent power module, 5880 LED I/O module, and 5865 LED annunciator.

7.3.1 Edit Modules

The features that can be edited when this option is selected are module name and class of wiring (Class A or Class B), or features that are specific to the module to be edited.

To edit an existing module:

1. Enter the installer code.
2. Press \blacktriangleright or  to display the main menu.
3. Select $\boxed{7}$ for Program Menu.

```
Display reads:      Initializing
                   Please wait . . .
```

4. Press $\boxed{1}$ to enter module menu.
5. Press $\boxed{1}$ to edit a module.
6. Use the \blacktriangle or \blacktriangledown arrow to select the module you wish to edit.

7.3.1.1 Naming Modules

You can assign an English name to a system hardware module to make it easier to recognize on a display.

7. If you wish to edit the modules name press the \blacktriangle or \blacktriangledown arrow to select each character for the modules name (or press \blacktriangleright to bypass name edit).

Press the \blacktriangleright to move to the next character.

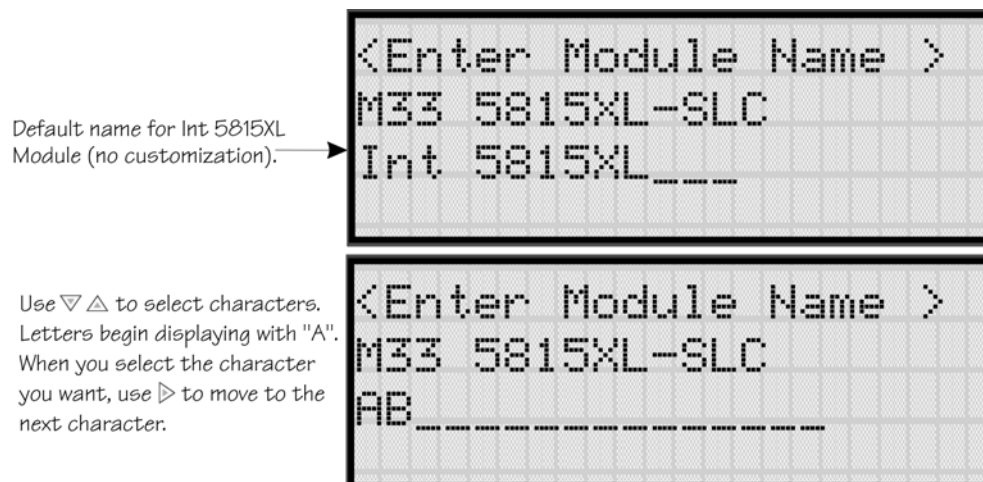





Figure 7-1 Edit module Name Programming Screen Example



7.3.1.2 Setting the 5815XL Wiring Class

8. Choose the class of wiring you wish to use for this module by pressing the  or  arrow, then press .



7.3.2 Adding a Module

If you need to add a new hardware module to the system, follow these steps.

You must be in the Main Menu to perform this task. If necessary, enter the Installer Code.

1. Enter the installer code.
2. Press  or  to display the main menu.
3. Select  for Program Menu.

```
Display reads:      Initializing
                  Please wait . . .
```

4. Press  to enter module menu.
5. Press  to add a module.
6. From the next screen, select the number that corresponds to the type of module you are adding from the <New Module Type> screen.

The screen will display “Adding module [#]...” for a few moments. You will be returned to the <New Module Type> screen where you can select another module if desired.



You must save changes when you exit the Program Menu or the new module will not be added.

Note: If you Add a Module that has not been physically connected, the panel will go into trouble after it reinitializes (when you exit the Program Menu). When the new module is attached, the trouble will correct itself automatically the next time you power up the system.



7.3.3 Deleting a Module

If you ever need to delete a module, follow these steps.

You must be in the Main Menu to perform this task. If necessary, enter the Installer Code.

1. Enter the installer code.
2. Press  or  to display the main menu.
3. Select  for Program Menu.

```
Display reads:      Initializing
                  Please wait . . .
```

4. Press  to enter module menu.
5. Press  to delete a module.
6. A warning screen will display. If you want to proceed with deleting the module, select Yes. To cancel, select No.



7.4 Zone

Through the zone option in the program menu you can edit, add, delete, and view zone points. Selections made here affect all detectors and switches in the zone. Up to 125 zones can be used in the system.



7.4.1 Edit Zone

Features that can be edited through the edit zone option are, edit zone name, zone properties (which includes, zone type, and detector sensitivity), and zone output mapping.

To edit a zone, follow these steps:

1. Enter the installer code.
2. Press  or  to display the main menu.
3. Select  for Program Menu.

```
Display reads:      Initializing
                  Please wait . . .
```

4. Press  to enter zone menu.
5. Press  to edit a zone.
6. Enter the zone number, then press .

7.4.1.1 Edit Zone Name

7. Press **[1]** to edit the selected zone's name.

A screen similar to the one shown in Figure 7-2 displays.

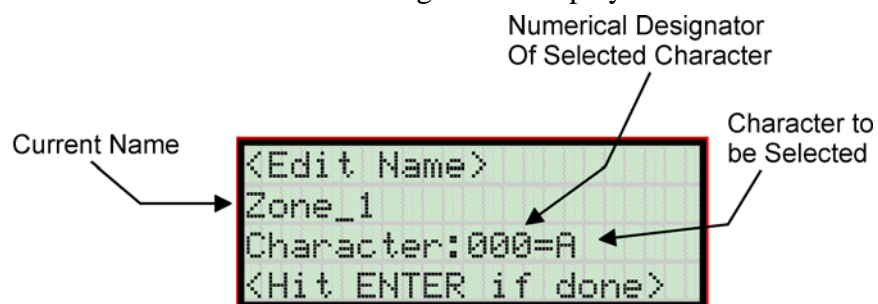

Figure 7-2 Selecting Character for Zone Name

8. Select the characters for the zone name by pressing the **▲** or **▼** arrow until the desired character is shown then press **▶**.

OR

Enter the Numerical Designator for the character you want, then press **▶**. See Appendix B for a list of available characters and their numeric designators.

9. Repeat step 8 until the name is complete.

10. Press **ENTER** when the name is complete.

7.4.1.2 Edit Zone Properties

Zone properties consist of alarm delay characteristics, and heat detector sensitivity.

1. Do steps 1 through 6 of Section 7.4.1.

2. Press **[2]** to edit the properties of the selected zone.

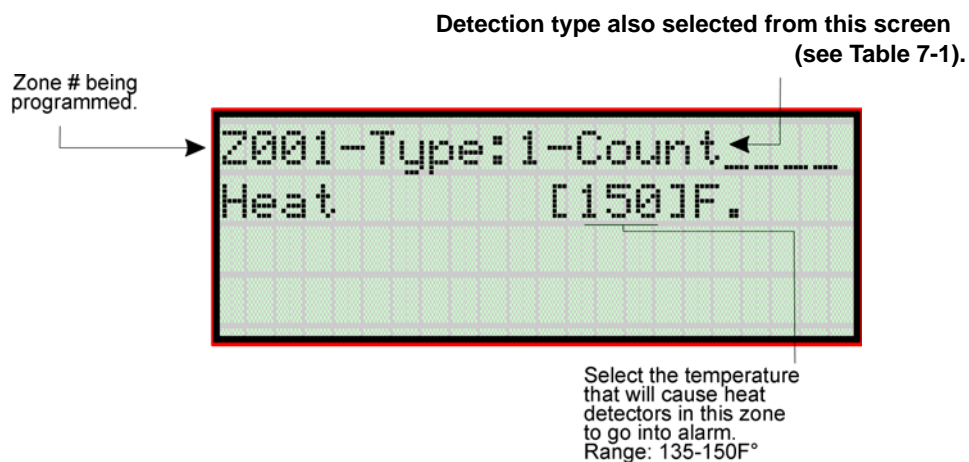

Alarm Delay Characteristics



3. Select the alarm delay characteristics (see Table 7-1) by pressing the  or  arrow.

Table 7-1: Alarm Delay Characteristics

Type of Delay	Description
1-Count	One Count (No Delay). When this option is enabled, an alarm occurs immediately when a single device of any of the following types goes into alarm: detector, manual pull, water flow, Aux1 or Aux2. This is considered the most typical operation and is the default for all zones.
2-Count	When this type of alarm delay is used, two or more detectors within the zone must go into alarm in order for the zone to report an alarm. Switches of type manual pull, water flow, Aux1 and Aux2 are an exception; they will cause an alarm when only one switch is in alarm. When a single detector is in alarm in a 2-Count zone, the system enters a prealarm condition. In a prealarm condition, the touchpad PZT beeps and the annunciator display indicates that a prealarm has occurred. If the zone has been mapped to an output group for the prealarm event, the output group will activate. The prealarm will not be reported to the central station.
Alarm Ver.	Alarm verification is an optional false alarm prevention feature that verifies an alarm condition by resetting the smoke detector. If the alarm condition still exists by the time the reset cycle has completed, the detector will go into alarm. If the detector is no longer in alarm, no report will go to the central station. The alarm verification sequence is ignored if the zone is already in alarm.
PAS	This option is intended to be used with an acknowledge switch. An alarm is delayed for 15 seconds, giving on-site personnel a chance to investigate the alarm. If the acknowledge switch is not activated within 15 seconds, an alarm occurs automatically. If this option is enabled for a zone, the zone will respond to an alarm condition as follows: <ul style="list-style-type: none"> • The zone will not go into alarm for 15 seconds to allow an on-site operator to activate the acknowledge switch. • If the operator does not press the acknowledge switch within 15 seconds, the zone will go into alarm. • If the operator presses the acknowledge switch within 15 seconds, a 180-second time-frame will begin counting down. This time-frame allows the operator to investigate the cause of the alarm. If the operator performs a reset within 180 seconds, the alarm will not occur. If the operator does not perform a reset within 180 seconds, an alarm will occur automatically. • The P.A.S. feature will be overridden if another alarm occurs.
SNGL ILOCK	See Section 8.7.1 for single interlock releasing operation.
DBL ILOCK	See Section 8.7.2 for double interlock releasing operation.

4. Press .



Heat Temperature Setting



Use this feature to set the temperature at which heat detectors will respond. The range is 135° to 150° F. All detectors in the zone will respond in the same way.

The Model SD505-AHS Heat Detector is an absolute temperature device. This means that it responds to an alarm immediately if the temperature in the zone goes above the programmed temperature.

5. Enter the temperature at which the heat detector will respond.

Or

Use the  or  keys to scroll through the range or enter directly from the number keys on the annunciator, then press .

6. Use the  or  keys to scroll through the range or enter directly from the number keys on the annunciator.

7. Then press .

7.4.1.3 Zone Outputs

Output groups and cadence patterns are mapped to events. They can be programmed to output when an event occurs in a zone. Some system trouble events can be mapped for the entire system. Section 6.2 of this manual contains a general explanation of mapping. The following sections explain how to select mapping options.

Note: Use of multiple notification groups may not synchronize with each other.









Mapping to Zone Events

Eight types of events can occur in zones. For each event type, you can activate up to 8 output groups or output group template, specifying a pattern for each. The following is a list of all event types:

Note: Abbreviations in the parentheses are the characters that are displayed in programming (see Figure 7-3).

- Manual Pull Alarm (MP)
- Water Flow Alarm (WF)
- Detector Alarm (DE). This applies to heat or smoke detectors.
- Aux 1 and Aux 2 Alarm (A1 or A2). User-specified alarm types.
- Pre-alarm (PR)
- Supervisory (SU)
- Trouble (TR)

To map zone events to outputs:

1. From the Installer Main Menu, select  for Program Menu.
2. From the Program Menu, select  for Zone.
3. From the next menu, select  for Edit Zone.
4. Enter the zone number you wish to edit.
5. From the next menu, select  for Zone Outputs.
6. From the next screen, a list of 8 event types will display. Select the event type you want to program. A screen similar to the one shown in Figure 7-3 will display. Press .
7. Press the  or  key to toggle the group letter to either G = Group or T = output group template depending on what you need for this zone. Press .

8. Select options for each event that could occur in this zone. Figure 7-3 is a complete example of how you might map a zone.

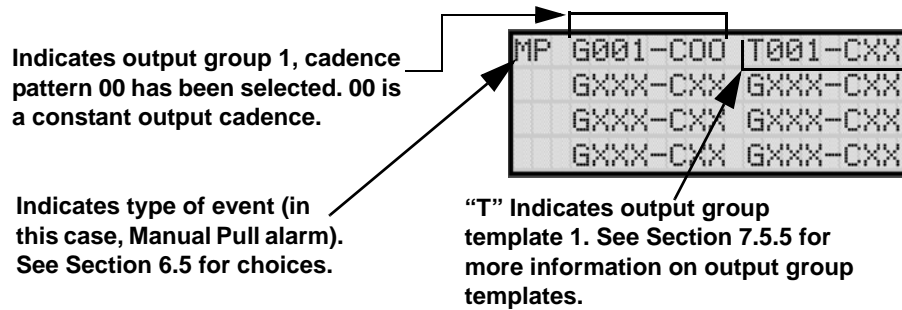

Figure 7-3 Selecting Output Groups/templates and Cadence Patterns for a Zone Event

Zone Mapping Example

Suppose you want to program Zone 1 so that:

- Any alarm (detector, water flow or manual pull) would activate Output Group 1 using the ANSI cadence pattern.
- Manual pull alarm would activate Output Group 3 using constant output.
- Troubles would activate Output Group 2 using the zone-coded cadence pattern.

To accomplish this you need to access the screen for each event and then select your output

groups. Figure 7-4 shows how you would program this application.

For this application:

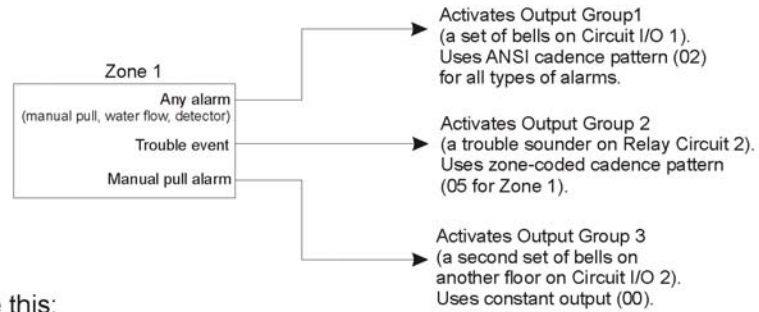

Program like this:

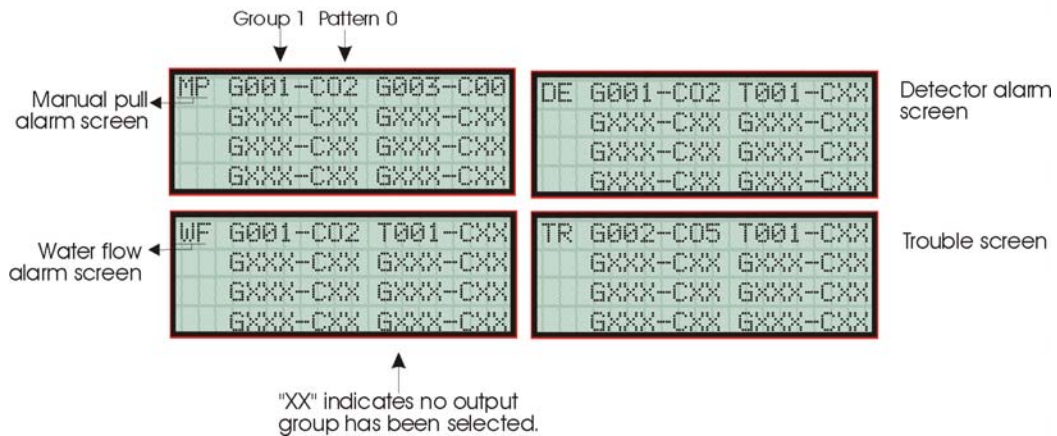

Figure 7-4 Zone Mapping Example

7.4.1.4 Cadence Patterns

The cadence patterns shown in Figure 7-5 are available for use with the control panel.

Cadence patterns can be selected by event type for each zone or for the entire system. Special cadence patterns can be selected for fire drills and any auxiliary system switches used with the system.



#	Name	Pattern Description																										
00	Constant	Continuous sound Note: This is the only pattern that can be used for relay circuits. The system will override any other choice.																										
01	March Code																											
02	ANSI 3.41																											
03	Single Stroke																											
04	California																											
05 ⋮ 16	Zone Coded	<table border="1" style="width: 100%;"> <thead> <tr> <th>Pattern#</th> <th>Zone</th> </tr> </thead> <tbody> <tr><td>5</td><td>Zone 1</td></tr> <tr><td>6</td><td>Zone 2</td></tr> <tr><td>7</td><td>Zone 3</td></tr> <tr><td>8</td><td>Zone 4</td></tr> <tr><td>9</td><td>Zone 5</td></tr> <tr><td>10</td><td>Zone 6</td></tr> <tr><td>11</td><td>Zone 7</td></tr> <tr><td>12</td><td>Zone 8</td></tr> <tr><td>13</td><td>Custom 1</td></tr> <tr><td>14</td><td>Custom 2</td></tr> <tr><td>15</td><td>Custom 3</td></tr> <tr><td>16</td><td>Custom 4</td></tr> </tbody> </table>  <p>→ This pattern multiplied by # of zone in alarm, followed by 3 seconds off.</p> <p>EXAMPLE: Pattern 06, Zone 2 coded</p> 	Pattern#	Zone	5	Zone 1	6	Zone 2	7	Zone 3	8	Zone 4	9	Zone 5	10	Zone 6	11	Zone 7	12	Zone 8	13	Custom 1	14	Custom 2	15	Custom 3	16	Custom 4
Pattern#	Zone																											
5	Zone 1																											
6	Zone 2																											
7	Zone 3																											
8	Zone 4																											
9	Zone 5																											
10	Zone 6																											
11	Zone 7																											
12	Zone 8																											
13	Custom 1																											
14	Custom 2																											
15	Custom 3																											
16	Custom 4																											
17 ⋮ 21	<table border="1" style="width: 100%;"> <thead> <tr> <th>Pattern #</th> <th>Sync Type</th> </tr> </thead> <tbody> <tr><td>17</td><td>Faraday</td></tr> <tr><td>18</td><td>Gentex</td></tr> <tr><td>19</td><td>System Sensor</td></tr> <tr><td>20</td><td>Wheelock</td></tr> <tr><td>21</td><td>AMSECO</td></tr> </tbody> </table>	Pattern #	Sync Type	17	Faraday	18	Gentex	19	System Sensor	20	Wheelock	21	AMSECO	<p>These outputs provide synchronization for AMSECO, Faraday, Gentex, System Sensor, or Wheelock synchronized appliances.</p>														
Pattern #	Sync Type																											
17	Faraday																											
18	Gentex																											
19	System Sensor																											
20	Wheelock																											
21	AMSECO																											

Figure 7-5 Cadence Patterns Available with the Control Panel

7.4.1.5 Zone Accessory Options

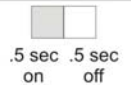
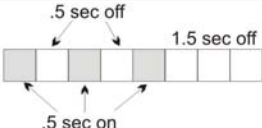
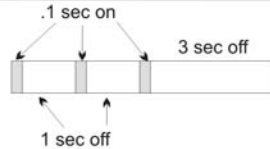

This option applies to detectors that are used with SD505-6SB, SD505-6RB, and SD505-ADHRs.

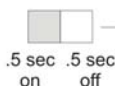
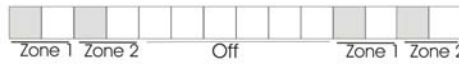
Single or Multi-station cadence pattern (choose from Patterns 00 to 21).



Local Zone (choose Y or N, for Yes or No).

7.4.2 Add Zone

To add a zone, follow these steps:

1. Enter the installer code.
2. Press  or  to display the main menu.
3. Select  for Program Menu.



```
Display reads:      Initializing
                   Please wait . . .
```

4. Press  to enter zone menu.
5. Press  to add a zone.



A zone will be added. The system will assign the next available zone number. Options for this zone can now be programmed through the Zone Edit sub-menu. Up to 125 zones can be used.

7.4.3 Delete Zone

To delete a zone, follow these steps:

1. Enter the installer code.
2. Press  or  to display the main menu.
3. Select  for Program Menu.



```
Display reads:      Initializing
                   Please wait . . .
```

4. Press  to enter zone menu.
5. Press  to delete a zone.



A warning screen will display. If you want to proceed with deleting the zone, select Yes. To cancel, select No.

7.4.4 View Zone Points

To view the points in a zone, follow these steps:

1. Enter the installer code.
2. Press  or  to display the main menu.
3. Select  for Program Menu.

Display reads: Initializing
 Please wait . . .

4. Press  to enter zone menu.
5. Press  to view zone points.
6. Enter the number of the zone you wish to view, then press .

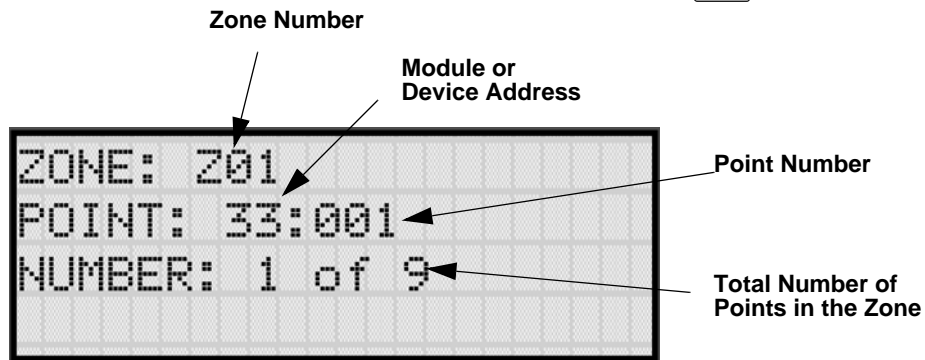

Figure 7-6 View Zone Points Screen

7.5 Group

An output group is made up of output points that have been programmed to respond in the same way. Output groups simplify programming because you have to program the output characteristics that are common to all of the group points once, instead of programming each individual point. Once you have defined the characteristics of output groups, you can assign each point to the appropriate group. All valid output points are assigned to only one output group. Unused points are not assigned to any output group. Up to 250 output groups can be defined.

7.5.1 Edit Group

In the edit group option you can program the name of an output group (Section 7.5.1.1) and change the properties (Section 7.5.1.2) of that group.

To edit a group, follow these steps:

1. Enter the installer code.
2. Press \blacktriangleright or **ENTER** to display the main menu.
3. Select **7** for Program Menu.
Display reads: Initializing
 Please wait . . .
4. Press **3** to enter group menu.
5. Press **1** to edit group.
6. Enter the number of the group you wish to edit, then press **ENTER**.

7.5.1.1 Edit Group Name

7. To edit the group name, press **1**.

A screen similar to the one shown in Figure 7-2 displays.

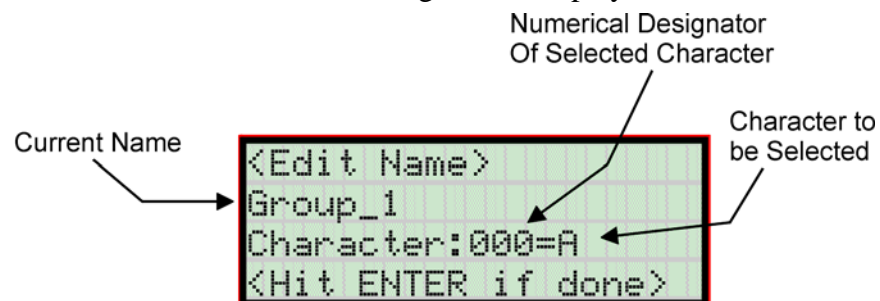

Figure 7-7 Selecting Character for Zone Name

8. Select the characters for the zone name by pressing the ▲ or ▼ arrow until the desired character is shown then press ►.

OR

Enter the Numerical Designator for the character you want, then press ►. See Appendix B of this manual for a list of available characters and their numeric designators.

9. Repeat step 8 until the name is complete.

10. Press **ENTER** when the name is complete.

7.5.1.2 Edit Group Properties

The Edit Group Menu allows you to select options for each group for the following items:

- Latching or non-latching outputs.
- Silencing operation.
- Operation with system switches.

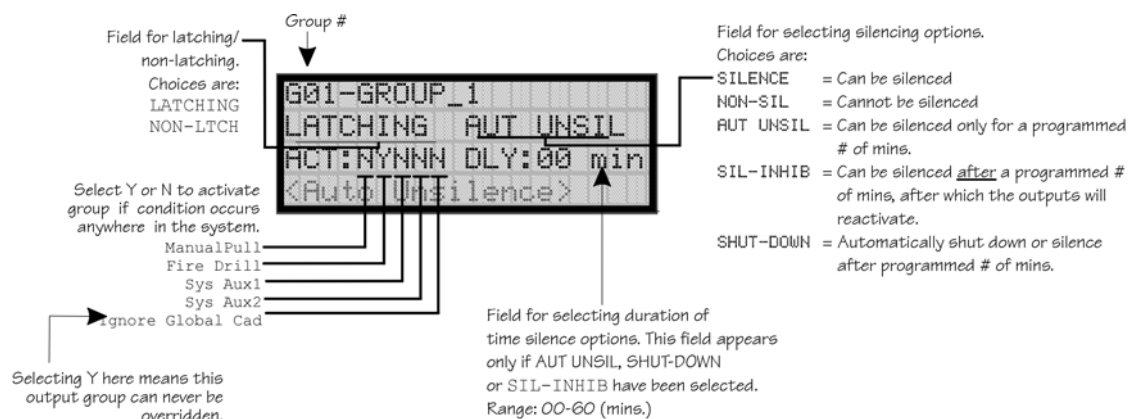

Figure 7-8 Group Properties Screen Programming Options

Latching / Non-latching Outputs

Outputs that are programmed as Latching remain active until the system has been manually reset. Non-latching outputs stop activating automatically when the condition clears.

Silencing Options

The following silencing options are available for each output group.

Table 7-2: Silencing Options

Option	Description
SILENCE	Silenceable. The output group can be silenced through the SILENCE key.
NON-SIL	Not silenceable. The output group cannot be silenced. Activation of the SILENCE key will be ignored for this output group.

Table 7-2: Silencing Options

Option	Description
AUT UNSIL	Auto Unsilenced. If this option is selected, the output group can be silenced for a programmed time-frame. If the condition that caused the output to activate has not cleared during the time-frame, the output reactivates. If you select this option, select the time-frame in the DLY: field. Range is 00-60 minutes. (See Figure 7-8 for location of field.)
SIL-INHIB	Timed Silence after Inhibit. If this option is selected, the output group must be audible for a programmed number of minutes before it can be silenced. If the condition that caused the output to activate has not cleared during the time-frame, the output can be silenced. If you select this option, select the timeframe in the DLY: field. Range is 00-60 minutes. (See Figure 7-8 for location of field.)
SHUT-DOWN	If this option is selected, the output group will automatically silence (shut down) after the programmed time period. If you select this option, select the timeframe in the DLY: field. Range is 01-60 minutes. (See Figure 7-8 for location of field.)



Response with System-Wide Conditions

You can select whether an output group will respond to various system-wide occurrences. (See Figure 7-8 for location of this field.)

Table 7-3: Output Group Response Choices



Option	Description
ManPull	Manual Pull Activation. Select Yes if you want this group to activate for all manual pull alarms that occur in the system. Note: Even though manual pull switches are assigned to zones, activation selected here for manual pull will override zone-programmed activation.
Fire Drill	Fire Drill Activation. Select Yes if you want this group to activate for fire drills.
Sys Aux1 and Sys Aux2	Select Yes if you want this output group to activate for system-wide Aux1 and Aux2 alarms. (Aux 1 and Aux 2 alarm types are for auxiliary alarm conditions. For example, you might want to use Aux 1 to provide a unique alarm type.)
Ignore Global Cad	Ignore Global Cadence. If you want to create an output group that can never be overridden, you can select Yes for this option. Selecting No means that system-wide events that have been assigned an output pattern could override the pattern for the output group. For example, suppose you had assigned a set of strobes to Output Group 3. You would never want these strobes to output in a pattern under any circumstances. To make sure this happens, select Yes for Ignore Global Cadence for Output Group 3.
Reverse Polarity	This option programs the output group for reverse polarity operation. Selecting Reverse Polarity–Troubles will cause the output group to be de-energized for any system trouble. Selecting Reverse Polarity–No Troubles will cause system troubles to be ignored. Activation is accomplished through standard mapping methods. Use with the 7644 assembly to implement reverse polarity. See Section 4.15.3.2 for more information on the 7644.

11. To get to this menu item repeat steps 1 through 6 of Section 7.5.1.
12. To edit group properties, press .
13. Press the or arrows to select the desired latching option.
14. Press .
15. Press the or arrows to select the desired silencing option. Refer to Table 7-2.



16. Press .
17. Enable group activation for a condition (see Table 7-3) by pressing the ▼ or ▲ arrows to select Y (yes) or N (no).
18. Press .
19. Repeat steps 14 and 15 for all the activation options.

7.5.2 Add Group

To add a group:



1. Enter the installer code.
2. Press  or  to display the main menu.
3. Select  for Program Menu.

Display reads: Initializing
 Please wait . . .



4. Press  to enter group menu.
5. Press  to add a group.

The system will assign the next available group number. Properties for the new group can now be edited if desired (see Section 7.5.1.2). A total of 250 output groups can be defined.

7.5.3 Delete Group

1. Enter the installer code.
2. Press  or  to display the main menu.
3. Select  for Program Menu.

Display reads: Initializing
 Please wait . . .

4. Press  to enter group menu.
5. Press  to delete a group.

A warning screen will display. If you want to proceed with deleting the group, select Yes. To cancel, select No.

7.5.4 View Group Points

1. Enter the installer code.
2. Press **▶** or **ENTER** to display the main menu.
3. Select **7** for Program Menu.

Display reads: Initializing
 Please wait . . .

4. Press **3** to enter group menu.
5. Press **4** to view group points.
6. Enter the group number, then press **ENTER**.



7.5.5 Edit Output Group Templates

Some installations may require that zones be mapped to more than 8 output groups. With output group templates you can combine one or all output groups into one template, which can be used when the same combination of outputs are used for several zones.

For example, lets say an installation has five zones (See Table 7-4). The check mark indicates what output groups are mapped to each zone. You will notice that every zone is mapped to outputs 1 and 2. As an alternative you can create a template that combines output group 1 and 2 as one choice.

Table 7-4: Zone Group Example

Zone	Group Number							
	1	2	3	4	5	6	7	8
1st Floor Smoke Detectors	✓	✓			✓			
2nd Floor Smoke Detectors	✓	✓			✓			
3rd Floor smoke Detectors	✓	✓			✓			
Manual Fire Pull Stations	✓	✓					✓	
Water Flow Switches	✓	✓						✓

This can be done by creating a template which includes output groups 1 and 2. Then you can map all the zones to the template you created. This will free up output group assignments that are common to several zones. This is very useful when you need to map zones to more than

eight output groups.

To create Output Group Templates:

1. From the Main Menu, select **[7]** for Program Menu.
2. From the Program Menu, select **[3]** for Group.
3. At the next screen, select **[5]** for Edit OPG Template.
4. Select the template number (01 - 08).
5. Select output group number. See Figure 7-9.

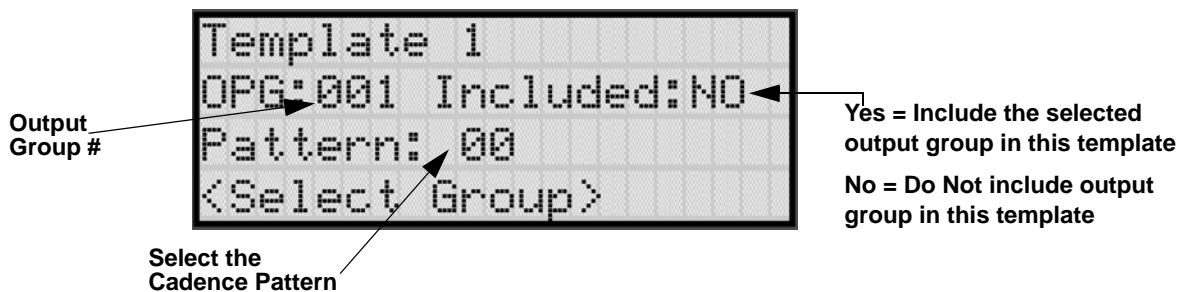

Figure 7-9 Output Group Template Programming Screen

7.6 Point

You may need to change characteristics of individual input points (detectors and switches) even after using JumpStart. This section explains how to change options for: type of input point; latching/non-latching status (switches); and name and zone assignment of a point.

7.6.1 Point Programming For 5815XL Module

To program for an 5815XL Module points, follow these steps:

1. Enter the installer code.
2. Press **▶** or **ENTER** to display the main menu.
3. Select **[7]** for Program Menu.
Display reads: Initializing
 Please wait . . .
4. Press **[4]** to enter point menu.
5. Press the **▽** or **▲** arrows to select the desired module. Refer to Section 6.5 Quick Reference Table for available choices.
6. Press **ENTER**.
7. Enter the number of the point you wish to edit.

8. Press .
9. Select the type of device by pressing the ▼ or ▲ arrows. Refer to Table 7-5 under column heading “Type Selection” for a list of choices.

Table 7-5: Point Programming Options for 5815XL Modules

Type Selection	Function	Latching Option	Comments
UNUSED			
DETECTOR	PHOTO		
	ION		
	HEAT		
	PHOT DUCT		
	ION DUCT		
	2WIRE SMK		
SUP DET	SUP PHOTO	Latching	
	SUP ION	Non Latching	

Table 7-5: Point Programming Options for 5815XL Modules

Type Selection	Function	Latching Option	Comments
SWITCH	MAN_PULL		Use this switch type for manual pull stations. This input is always latched. The switch can clear only when an alarm is reset. This switch type has the highest priority; it overrides any other type of alarm.
	WATERFLOW	Latching	Use this switch type for monitoring water flow in a sprinkler system. Switch closure will cause a sprinkler alarm. Water flow switches can be programmed as latching or non-latching. You can program a delay of up to 90 seconds to be used with a water flow switch. The delay allows for normal, brief changes in sprinkler system water pressure. The water flow alarm will not activate unless the switch is active for the programmed delay time. If a delay is used, the system begins counting down when the switch closes. If the switch opens (restores) before the timer expires, a water flow alarm is not generated. If the water flow switch remains closed after the timer expires, a water flow alarm will be generated.
		Non Latching	
	SUPERVISY	Latching	Use this switch type for tamper monitoring of sprinklers and other fire protection devices. If a contact closes, a sprinkler supervisory event will be generated. Supervisory switches can be latching or non-latching.
		Non Latching	
	FIREDRILL		System-level, non latching switch. This switch is an alternative way of causing a fire drill. It has the same operation as the fire drill option available from the annunciator. When the switch is activated, a fire drill begins; when the switch is de-activated, the fire drill ends.
	SILENCE		This system-level switch is an alternative way to silence the system. It has the same effect as pressing the SILENCE key.
	RESET		This system-level switch is an alternative way to reset the system. It has the same effect as pressing the RESET key.
PAS_ACK		Positive acknowledge switch. This switch must be used in zones programmed as Positive Alarm Sequence (see Table 7-1). If an acknowledge switch closes when an alarm or trouble condition is not already in progress, a trouble will occur. You must use a UL listed normally open, momentary switch type. The switch must be rated at 5V, 100 mA (minimum) and be used with an EOL resistor for supervision.	

Table 7-5: Point Programming Options for 5815XL Modules

Type Selection	Function	Latching Option	Comments
SWITCH (cont.)	ZN_AUX1	Latching	Use these switch types if you want to monitor special zone-level conditions (such as operation of a fan or damper).
		Non Latching	
	ZN_AUX2	Latching	
		Non Latching	
	SYS_AUX1	Latching	Use these switch types if you want to monitor special system-wide conditions (such as operation of a fan or damper).
		Non Latching	
	SYS_AUX2	Latching	
		Non Latching	
	DETECT SW		Used to monitor conventional 4-wire detectors, a contact closure will generate a detector alarm event.
	TAMPER	Latching	Performs identically to a supervisory switch, but will be indicated as a tamper switch on the LCD annunciator.
Non Latching			
MAN REL	Latching	Manual release switch, typically a pull station.	
	Non Latching		
ILOCK	Latching	Interlock release switch input.	
	Non Latching		
NOTIF	OUTPUT PT	Select Group	Output Point, a general use notification type. Use for driving standard notification appliances.
	AUX CONST		Use constant power for applications that require a constant auxiliary power source. Power is always present at Constant circuits.
	AUX RESET		Use for auxiliary power, resettable applications. See Section 4.13.5.3 for a description of how this option operates.
	AUX DOOR		Use for auxiliary power, door holder applications. For example, if you were using an auxiliary power supply for door holders, you would use this option. See Section 4.13.5.1 for a description of how this option operates.
RELAY	OUTPUT PT	Select Group	Output Point, a general use relay type. Use for applications requiring a relay, such as fan shutdown, elevator recall, and so on.
	AUX RESET	Select Group	Use for auxiliary power, resettable applications. See Section 4.13.5.3 for a description of how this option operates.
	AUX DOOR	Select Group	Use for auxiliary power, door holder applications. For example, if you were using an auxiliary power supply for door holders, you would use this option. See Section 4.13.5.1 for a description of how this option operates.



Table 7-5: Point Programming Options for 5815XL Modules

Type Selection	Function	Latching Option	Comments
SLC LED	Select LED No. 01 -80	Select Group	

7.6.2 Point Programming For Internal or External Power Module (5895XL)

To program for an internal or external power module points:



1. Enter the installer code.

2. Press  or  to display the main menu.

3. Select  for Program Menu.

Display reads: Initializing
 Please wait . . .



4. Press  to enter point menu.

5. Press the  or  arrows to select the desired module. Refer to Section 6.5 for available choices.

6. Press .

7. Enter the number of the circuit or point you wish to edit. Refer to Table 7-6 for available selections.



8. Press .

9. Select the type by pressing the  or  arrows.

10. Press .

11. Select the function by pressing the  or  arrows.

12. Press .

13. Select the zone by pressing the  or  arrows.

14. Press .

15. Edit point name. See Section 7.6.3.1.

Or

Press ► to skip point name edit.



16. Repeat Steps 1 through 15 for all circuits.

Table 7-6: Menu choices for Internal/External Power Module





Choices	Type Selections	Function Selections for each Type	Comments
Enter Point or Circuit			
Select Type	UNUSED		
	B NOTIF		
	A NOTIF		
	AUX PWR	CONSTANT	Constant auxiliary power.
		RESETTABLE	Resettable auxiliary power.
		DOOR	Door holder auxiliary power.
	B SWITCH	MAN PULL	Refer to comments column of Table 7-5 for description of these options. Latch or Non-latching feature only appears for waterflow, supervisory, tamper, zone aux1, zone aux2, system aux1, and system aux2.
		WATERFLOW	
		SUPERVSY	
		TAMPER	
		FIREDRILL	
		SILENCE	
		RESET	
		PAS_ACK	
		ZN_AUX1	
		ZN_AUX2	
		SYS_AUX1	
		SYS_AUX2	
		MAN REL	
	ILOCK		
A SWITCH	Same as B SWITCH	Used for	
B DETECTOR	2-WIRE SMK	Used for Class B, 2-wire detectors.	
	4-WIRE SMK	Used for Class B, 4-wire detectors.	
A DETECTOR	2-WIRE SMK	Used for Class A, 2-wire detectors.	
	4-WIRE SMK	Used for Class A, 4-wire detectors.	
Select Zone/Group			Group or Zone selection will appear depending on the type selected.
Edit Name			See Section 7.3.1.1.

7.6.3 Point Programming For 5880 and 5865 Modules

To program 5880 or 5865 module points:

1. Enter the installer code.
2. Press  or  to display the main menu.
3. Select  for Program Menu.

Display reads: Initializing
 Please wait . . .

4. Press  to enter point menu.
5. Press the  or  arrows to select the desired module. Refer to Section 6.5 for available choices.
6. Press .

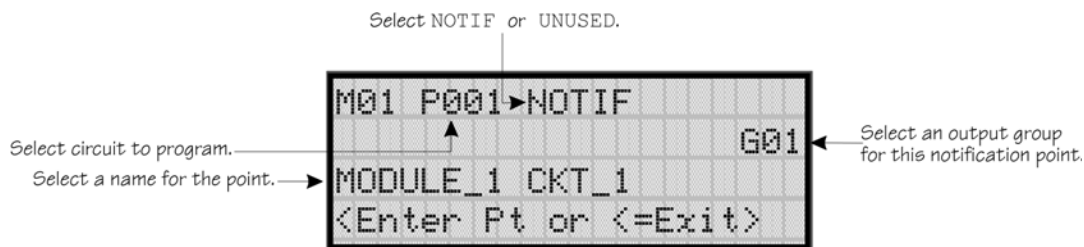









Figure 7-10 Programming Points Screen for 5880 and 5865 Modules

7. Enter the point number.
8. Press .
9. Press the  or  arrows to select the type (Notification or unused).
10. Press .
11. Press the  or  arrows to select the desired Group.
12. Press .
13. Edit module name. See Section 7.6.3.1.

Or



Press  to skip module name edit.

14. Repeat Steps 1 through 13 for all points.

7.6.3.1 Assigning a Name to Points

You can assign a name to a point to make it easier to recognize on a display.

To edit a point name:

1. Do steps 1 through 4 in Section 7.6.3.
2. Using the \blacktriangle or \blacktriangledown arrow, select the module of the point you want to edit, press .
3. Enter the point number.
4. Press \blacktriangleright until the module name is blinking.
5. Press .

A screen similar to the one shown in Figure 7-2 displays.

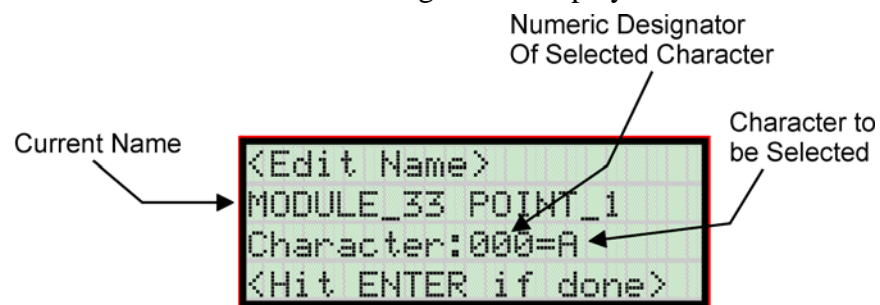



Figure 7-11 Selecting Character for Zone Name

6. Select the characters for the point name by pressing the \blacktriangle or \blacktriangledown arrow until the desired character is shown then press \blacktriangleright .

OR

Enter the Numerical Designator for the character you want, then press \blacktriangleright . See Appendix B for a list of available characters and their numeric designators.

7. Repeat step 6 until the name is complete.
8. Press  when the name is complete.

7.7 System Options

This section of the manual explains how to customize software options that affect general operation of the system. This includes such items as: AC loss hours, system clock options, holidays schedule, telephone and reporting account options. Refer to each individual subsection for complete instructions.

7.7.1 Reporting Account



Up to four reporting accounts can be used with the control panel. Events in accounts are reported by zone.

Each account is assigned an up-to-6-digit account number. Each account is also assigned a unique ID (1-4) which determines the priority for reporting ("1" has the highest priority; "4" has the lowest).



Disable any unused accounts by selecting "N" for all events (see Figure 7-12). If the system is local only (does not connect to a central station), disable all events for all four reporting accounts.

Options for each account can be customized. These options appear on the Reporting Accounts screen. Some related options appear on the Phone Lines screen (see Section 7.7.2).

To access the Reporting Accounts screen:

1. Enter the installer code.
2. Press ► or  to display the main menu.
3. Select  for Program Menu.

Display reads: Initializing
 Please wait . . .

4. From the Program Menu, select  for System Options.
5. From the next menu, select  for Reporting Accounts.

7.7.1.1 Edit Accounts

6. From the next menu, select for Edit Account.

A screen similar to one shown in Figure 7-12 will display. The following subsections describe the options on each field.

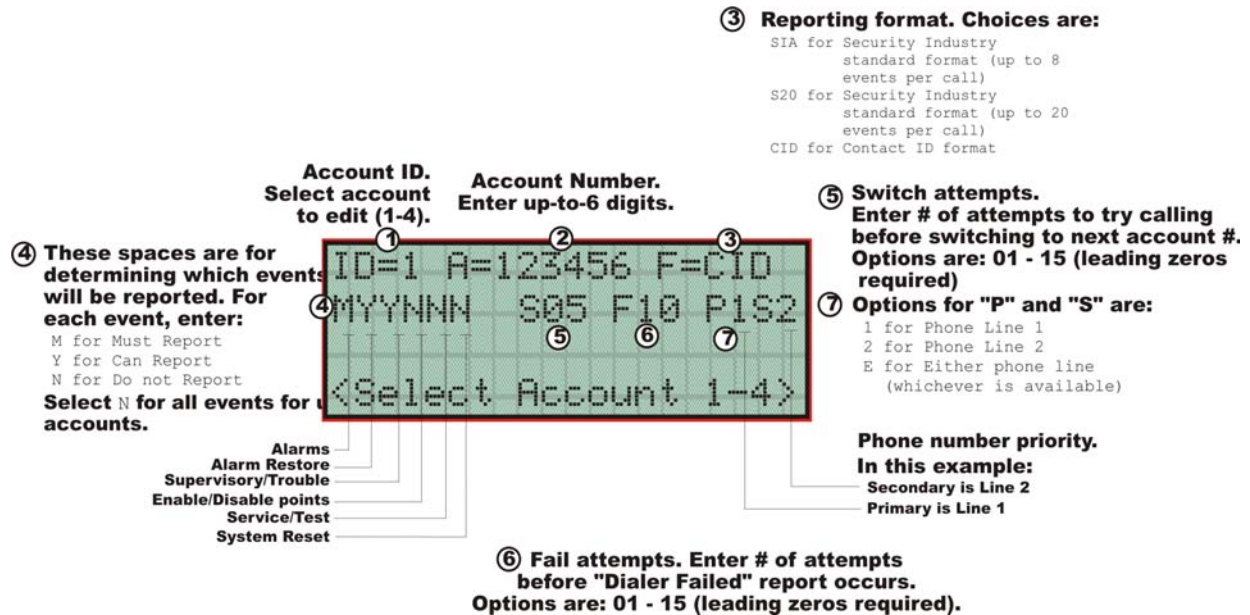

Figure 7-12 Reporting Account Editing Screen

Select Account (ID)

The control panel provides up to 4 reporting accounts. The priority of an account is based on its account ID. Account 1 is highest priority; Account 4 is lowest. Use Account 1 to report the highest priority events.

7. Press the or arrow to select account ID number, then press .

Edit Account Number

Enter an up-to-6-digit number for each account to identify the account to the central station. See Figure 7-12 for location of this option on the screen. The account number should be compatible with the reporting format used. For example, the Contact ID format transmits up to four digits only.

8. Enter the desired account number (up to 6-digits), then press .

Select Reporting Format

Select a reporting format for each account. Options are:



SIA	SIA format. 8 events per call.
CID	Ademco's Contact ID format
S20	Same as SIA but limits events reported to 20 events per phone call.

9. Press the or arrow to select the reporting format, then press .

Events to Report

The next six options select which types of events (or event families) will be reported to this account. (See Figure 7-12 for location of these options on the screen.) Events are reported by zone.

Event Family	Events Included in this Family
Alarms	All alarms (Water Flow, Manual Pull, Detectors, Auxiliary Switches)
Alarm Restore	All alarm restores.
Supervisory/Trouble	All trouble and supervisory conditions and trouble and supervisory restores.
Enable/Disable Point	Enabling and disabling of input and output points.
Service/Test	Fire drill, walk test, dialer test, automatic test, all programming sessions.
System Reset	All system resets.

10. Press the  or  arrow to select Must, Yes, or No (see table below), then press .



11. Repeat step 10 for all six event report options.

For each event family, select M, Y, or N.

M(ust)	Must Report. Selecting "M" makes this a primary reporting account for this family of events. The dialer MUST report events in this family to this account. Selecting Must makes an account a primary reporting account. The dialer will try to report the event to the primary account until it exceeds the "Switch Attempts" value. When the dialer has exceeded the Switch Attempt retry limit, it will switch to a backup account (a "Can Report" or "Yes" account, see below). If the dialer cannot report the event to any of the backup accounts, it will return to the primary account and repeat the process until it exceeds the "Fail Attempts" value. If the Fail Attempts limit is exceeded, an Account Trouble condition is generated and a local trouble will sound.
Y(es)	Can Report. Selecting Y makes this a backup account for this event family. The dialer will report to this account only if it was previously unable to report the event to a Must account.
N(o)	No events in this family will ever be reported to this account.



Switch Attempts

Specify the number of times the dialer should attempt to report to this account before switching to the next account. Range is 01-15.

12. Enter the number of switch attempts (or press the  or  arrow), then press .



Fail Attempts

This feature specifies the number of times the dialer should attempt to perform the dial/switch sequence before issuing an account trouble condition. Range is 01 - 15 (Default = 10).

13. Enter the number of fail attempts (or press the  or  arrow), then press .

Selecting Primary and Secondary Phone Lines

For each account, select which phone line (Line 1 or Line 2) is primary. See Figure 7-12 for an example of how to make this selection.

14. Press the  or  arrow to select line 1 or 2 as primary phone line, then press .

15. Repeat step 14 for the secondary phone line.

Telephone Number

Enter up to 40 characters for phone number for this account.

Enter up to 40
characters for the
phone of the account.

Comma adds a 2
second pause.



The following special characters are available:

Table 7-7: Special Character for Dialing



#	Pound (or number) key on the telephone
*	Star key on the telephone
,	Comma (character for 2-second pause)

Use the number buttons on the annunciator or the up- and down-arrow keys to select special characters. Characters begin displaying after “9”. See Figure 7-12 for an example.

7.7.1.2 Auto Test Time

To access the automatic dialer test time screen:

1. Enter the installer code.

2. Press  or  to display the main menu.



3. Select  for Program Menu.

```
Display reads:      Initializing  
                  Please wait . . .
```



4. From the Program Menu, select  for System Options.

5. From the next menu, select  for Reporting Account.

6. From the next menu, select  for auto test time.

7. Enter the hour you desire the control panel to send an automatic test report (or press the  or  arrow), then press .



8. Enter the minutes (or press the  or  arrow), then press .

9. Select AM or PM by pressing the  or  arrow, then press .

7.7.2 Phone Lines

To access the phone lines screen:

1. Enter the installer code.

2. Press  or  to display the main menu.

3. Select  for Program Menu.

```
Display reads:      Initializing  
                  Please wait . . .
```

4. From the Program Menu, select  for System Options.

5. Select  for the phone lines menu.

6. Select the phone line to be edited (1 or 2) by pressing the \blacktriangle or \blacktriangledown arrow, then press .

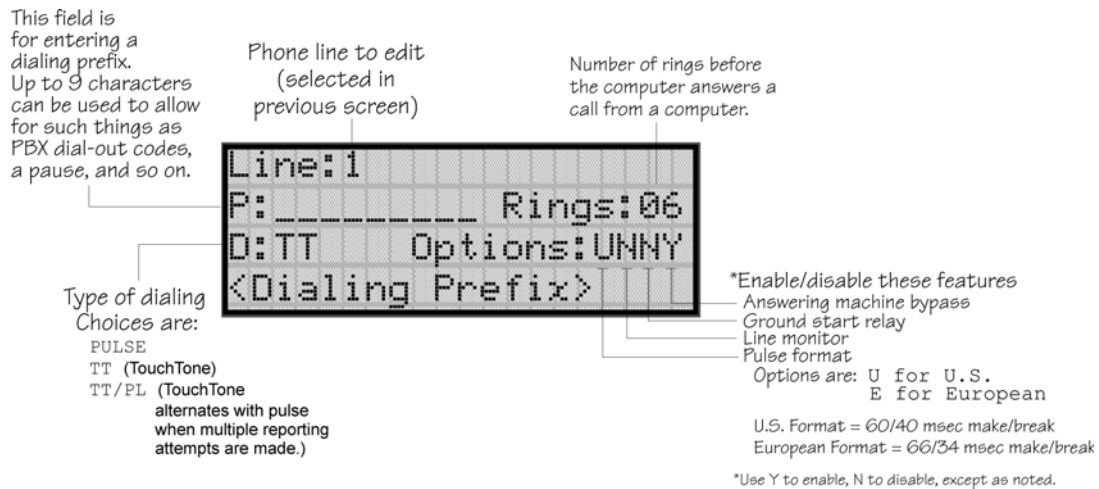



Figure 7-13 Phone Lines Editing Screen

7.7.2.1 Dialing Prefix

Enter up to 8 characters to be used for such things as PBX dial-out codes, a pause, and so on. The following special characters are available:

- # Pound (or number) key on the telephone
- * Star key on the telephone
- , Comma (character for 2-second pause)

Use the number buttons on the annunciator or the up- and down-arrow keys to select special characters. Characters begin displaying after “9”. See Figure 7-13 for an example.

7. Enter a dialing prefix (if needed), then press .

Or

Press \blacktriangleleft to bypass the dialing prefix option.

7.7.2.2 Number of Answer Rings

This option is used in conjunction with the 5660 SKSS. Use the option to determine the number of rings before the panel answers a call from the computer. Range is 00-15 rings. This option is factory-programmed as 06 rings, which should be compatible for most installations where the answering machine bypass feature is used. You may need to adjust it depending on the installation's telephone system.

The selection made here must match the programming for this option in the Communication Configuration dialog box of the 5660 SKSS. See the software manual for more information (PN 151240).

8. Enter the desired number of answer rings, then press .

7.7.2.3 Dial Option (TouchTone or Pulse)

9. Press the  or  arrow to select the dial option, then press .

Dial Option	Description
PULSE	If this option is selected, only pulse dialing will be used for this phone line.
TT	TouchTone dialing. If this option is selected, only TouchTone dialing will be used for this phone line.
TT/PL	TouchTone alternating with pulse. If this option is selected, the dialer will first attempt to use TouchTone. It will switch to pulse if TouchTone is not successful on the first attempt. It will continue to alternate between TT and pulse for additional attempts.

7.7.2.4 Rotary Format

10. Press the  or  arrow to select the pulse ratio for rotary dialing option, then press



Options are:

- U U.S. standard format. Uses the 60 msec / 40 msec make/break ratio.
- E European format. Uses the 66 msec / 34 msec make/break ratio.

7.7.2.5 Line Monitor

Enable the line monitor for each phone line that will be used. See Figure 7-13 for location of this field on the phone lines screen. When the phone line monitor has been enabled for a phone line, a trouble condition will occur if the line is not connected. If a phone line will not be used, it must be disabled.

11. Select Y (monitor line) or N (don't monitor line) by pressing the  or  arrow, then press .

7.7.2.6 Ground Start Relay

If using the 5211 ground start relay, you must enable the ground start relay programming option. See Figure 7-13 for the location of this field on the phone lines screen. This option is

disabled by default. For 5211 installation, see Section 4.12.

Note: Ground start cannot be used in UL installations.

12. Select Y (ground start used monitor line) or N (ground start not used don't monitor line) by pressing the ▲ or ▼ arrow, then press .

7.7.2.7 Answering Machine Bypass





This option is used in conjunction with the 5660 SKSS. This feature ensures that an answering machine will not interfere with communication between the panel and the computer. If an answering machine is used at the panel site, enable this feature; if an answering machine is not used, disable the feature.

This option is factory-programmed as Yes (enabled).

The selection made here must match the programming for this option in the Communication Configuration dialog box of the 5660 SKSS. See the 5660 SKSS manual for more information (PN 151240).

13. Select Y (answering machine bypass enabled) or N (answering machine bypass disabled) by pressing the ▲ or ▼ arrow, then press .

7.7.3 Sys. Event Outputs

1. Enter the installer code.
2. Press ▶ or  to display the main menu.
3. Select  for Program Menu.
 Display reads: Initializing
 Please wait . . .
4. From the Program Menu, select  for System Options.
5. From the System Options Menu, select  for Sys. Event Outputs.

7.7.3.1 Trouble Events

You can map certain system trouble events to an output group. To access the screen for selecting output groups and cadence patterns for system trouble events.

- Press **[1]** for Trouble Events. A screen similar to the one in Figure 7-14 will display. Select a group and a cadence pattern for each event as needed for your application. The U: field is for a user-specified trouble condition. You can program an output group and cadence pattern for any of the following events:

Battery	Low battery condition.
Gnd Flt	Ground fault.
Phone Ln	Phone Line 1 or 2 trouble.
Account	Account trouble; cannot report to account.
Printer	Printer trouble. (Currently not supported; do not select.)
Aux Pwr	Auxiliary power trouble.
Sys Sw	Trouble with a system switch.
Group Tr	Trouble with an output group.
SBUS Com	SBUS communication trouble.
SBUS Pwr	SBUS power trouble.
SLC Loop	Trouble on the SLC loop.
AC Loss	AC power lost.

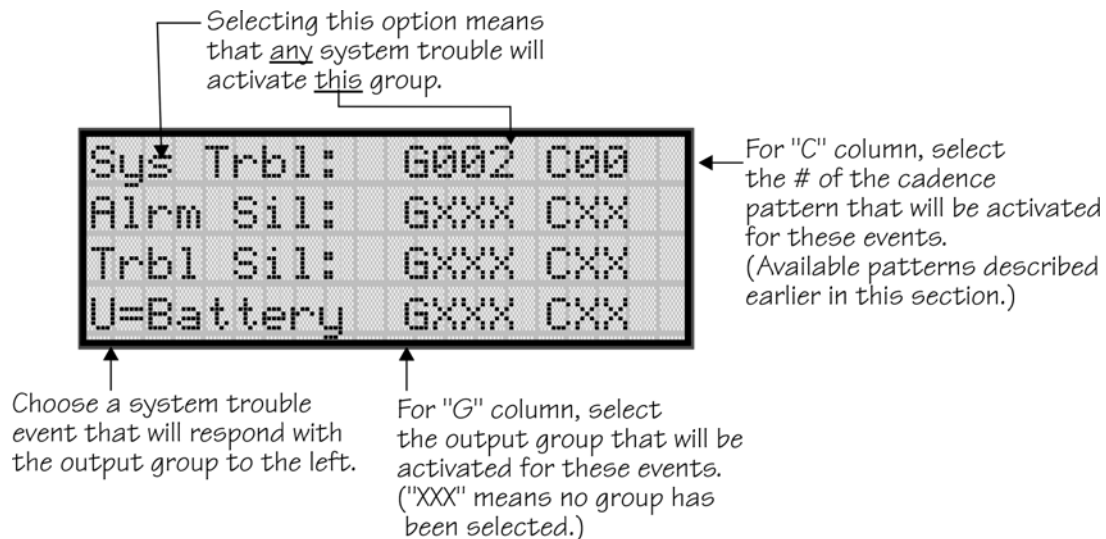

Figure 7-14 System Trouble Event Mapping Example

7.7.3.2 System Alarm Cadence

Fire drill and system auxiliary alarm events can have special cadence patterns to distinguish them from other types of alarms. See Section 7.4.1.4 for available cadence patterns.

A typical use of the System Aux1 and Aux2 patterns is to distinguish fire emergencies from other types of emergencies. The System Aux1 and Aux2 alarms would be triggered by a system-wide switch.

To access the screen for selecting output groups and cadence patterns for system trouble events:

1. Enter the installer code.
2. Press \blacktriangleright or **ENTER** to display the main menu.
3. Select **7** for Program Menu.

Display reads: Initializing
 Please wait . . .

4. From the Program Menu, select **5** for System Options.
5. From the System Options Menu, select **2** for Sys. Event Outputs.
6. Press **2** for System Alarm Cadence.

A screen similar to the one in Figure 7-15 will display. Select a cadence pattern for these special events if required for your application.

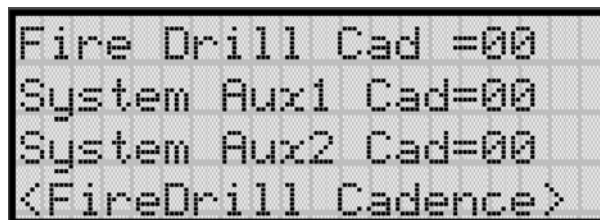

```
Fire Drill Cad =00  
System Aux1 Cad=00  
System Aux2 Cad=00  
<FireDrill Cadence>
```

Figure 7-15 Special Cadence Patterns for Fire Drill and Auxiliary Alarm Events



7.7.4 Miscellaneous Options 1

Through this programming option you can set the water flow delay time, low AC report delay, enable or disable automatic daylight savings time adjustment, clock format, and AC clock frequency.



7.7.4.1 Water Flow Delay

You can program a delay of 0-90 seconds (zero means no delay) to be used in conjunction with a water flow switch. The delay is system-wide. All water flow switches on the system will use the same delay period.

To access the screen for programming water flow delay, follow these steps:

1. Enter the installer code.
2. Press  or  to display the main menu.
3. Select  for Program Menu.

Display reads: Initializing
 Please wait . . .

4. Select  for System Options.
5. Select  for Miscellaneous Options 1.

A screen similar to the one shown in Figure 7-16 will display.



Figure 7-16 Water Flow Delay Programming Screen

6. Enter the number of seconds (0 to 90) to delay an a water flow switch alarm, then press



7.7.4.2 Low AC Report Delay

Note: You must select 1-3 hours in UL central station installations and UL remote signaling installations.

You can adjust the number of hours before a Low AC report will be sent to the central station.

To program low AC report delay, follow these steps:

Note: Steps continued from step 6 of Section 7.7.4.1.

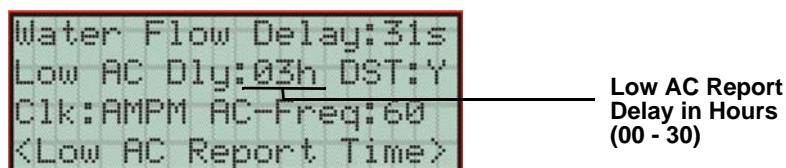

Figure 7-17 Low AC Report Delay Programming Screen

- Enter the number of hours before a low AC report will be sent to the central station, then press . Refer to Figure 7-17.

7.7.4.3 Automatic Daylight Savings Adjustment

The control panel has an automatic DST (Daylight Saving Time) adjustment feature. Before January 2007, if this feature is enabled (set to *Yes*), the system clock will switch to DST on the first Sunday in April at 2:00 a.m. and revert to standard time on the last Sunday in October at 2:00 a.m. After January 2007, if this feature is enabled, the system clock will start and end DST according to the settings made in Misc. Options 3 (see Section 7.7.6.3). If this feature is not enabled (set to *No*) the Daylight Saving Time change is not made to the system clock.

To enable or disable DST adjustment continue programming from step 7 above:

- Select Y (enabled) or N (disabled) by pressing the or arrow, then press .

7.7.4.4 Clock Display Format (AM/PM or Military)

To change the system clock display format, continue programming from step 8 above:

- Select AMPM (for AM/Pm display format) or MIL (for military or 24 hr display format) by pressing the or arrow, then press .

7.7.4.5 Change AC Line Frequency

The panel's AC line frequency is selectable for 50, 60 Hz, or Neither. AC Frequency feature dictates how the control panel will calculate time based on the AC line frequency used in the installation site. The "Neither" option can be used in areas where the AC line frequency is not dependable and you want the panel to calculate time from the internal crystal. The internal crystal is not as accurate as the AC power source and either 60 Hz or 50 Hz should normally selected. The panel defaults to the 60 Hz. selection



To change the AC line frequency, continue programming from step 9 above:

- Select 50, 60 or Neither, by pressing the or arrow, then press .



7.7.5 Miscellaneous Options 2

Through this programming option you can turn the strobe synchronization during silence feature On or Off, and select the control panel to report events by zone or by point.

To edit miscellaneous options 2:

1. Enter the installer code.
2. Press  or  to display the main menu.
3. Select  for Program Menu.





```
Display reads:      Initializing
                  Please wait . . .
```

4. Select  for System Options.
5. Select  for Miscellaneous Options 2.

7.7.5.1 Synchronize Strobes Active During Silence

When "SYNC Strbs w/ Sil:" is Selected as Y (Yes) then strobes will continue to flash when the system is silenced and will stop flashing when the system is reset.





Note: The "SYNC Strbs w/ Sil:" only functions with outputs that use a synchronized output pattern.

6. Press the  or  arrow to toggle this selection between Y (Yes) or N (No).
7. Press  or  to make your selection and move to the next programming option.

Note: See Section 7.4.1.4 for more information about Synchronization protocol choices.





7.7.5.2 Auto Display Oldest Event

When this feature is programmed Y (Yes) then the oldest un-acknowledge event will automatically display on the control panel and remote annunciators after there has been no activity on any system touchpad for two minutes.

8. Press the  or  arrow to toggle this selection between Y (Yes) or N (No).
9. Press  or  to make your selection and move to the next programming option.

7.7.5.3 Report by Zone or by Point



When the "Report by" option is set to Zone, then the control panel will report events by zone. If Point is selected then the control panel will report events by point.

10. Press the  or  arrow to toggle this selection between Zone or Point.
11. Then press  or . See Section 9 for reporting codes.



7.7.6 Miscellaneous Options 3

From Miscellaneous Options 3, you set the alarm verification time, turn the Plex Door option on/off, and set the start and end week and month of Daylight Saving Time.

To edit Miscellaneous Options 3:

1. Enter the installer code.
2. Press  or  to display the main menu.
3. Select  for Program Menu.
4. Enter code if prompted.



Display reads: Initializing
 Please wait . . .

5. Select  for System Options.
6. Select  for Miscellaneous Options 3.

7.7.6.1 Alarm Verification Time

You can set the alarm verification time from 1 to 250 seconds (default is 60 seconds).





To set the alarm verification:

7. Enter the desired number of seconds for the alarm verification time.
8. Press  or  to make your selection and move to the next programming option.

7.7.6.2 Plex Door Option

If installing the plex door hardware (PN Plex-1), you must turn the Plex Door option *On* as described in this section.

To turn the Plex Door option on/off:

9. Press the  or  arrow to toggle this selection between Y (Yes) or N (No).
10. Press  or  to make your selection and move to the next programming option.













7.7.6.3 Daylight Saving Time Start and End

This option lets you to adjust the week and month Daylight Saving Time (DST) starts and ends. For this feature to work, you must enable (set to *Yes*) the DST option under Misc. Options 1 (see Section 7.7.6.3). You can view and change the settings in this option anytime, however, settings will not take effect until 2007. The default values for the DST Start and End options reflect the August 8, 2005 DST law that goes into effect in 2007:

DST Start: The second Sunday in March

DST End: The first Sunday in November

To set the start and end for Daylight Saving Time:



11. Press the  or  arrow to select the week (1st, 2nd, etc.) Daylight Saving Time starts, then press  to make your selection and move to the month setting.
12. Press the  or  arrow to select the month (January – December) Daylight Saving Time starts, then press  to make your selection and move to the DST End option.
13. Press the  or  arrow to select the week (1st, 2nd, etc.) Daylight Saving Time ends, then press  to make your selection and move to the month setting.
14. Press the  or  arrow to select the month (January – December) Daylight Saving Time ends, then press  two times to make your selection and exit Misc. Options 3.

7.7.7 Edit Banner Message



The banner is the message that displays on the panel LCD when the system is normal, that is, when no alarms or troubles exist and no one is currently using system menus. You can create a customized message, which can be up to 40 characters, two lines of 20 characters each.

If you do not create a customized message, the system will use the internal banner. You cannot change the internal banner.

To customizing the banner display message:

1. Enter the installer code.
2. Press  or  to display the main menu.
3. Select  for Program Menu.

Display reads: Initializing
 Please wait . . .

4. Select  for System Options.
5. Select  for Edit Banner. A screen similar to the one shown in Figure 7-18 will display.

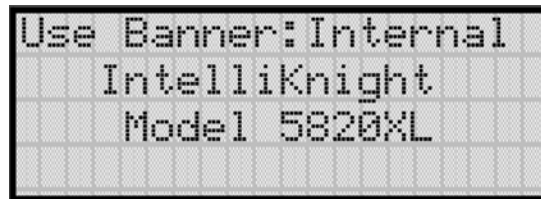

Figure 7-18 Internal Banner Message







6. Press the  or  arrow to select “Custom”, then press . A screen similar to the one shown in Figure 7-19 will display.



Figure 7-19 Custom Banner Edit Screen







7. Select each letter by pressing the  or  arrow, then press  to move to the next character.
8. When done, press  to move to line two of the custom banner. Repeat step 7 and 8.

7.8 JumpStart Autoprogramming

IMPORTANT!

JumpStart is intended to be used prior to performing any custom programming. Each time JumpStart is executed, all options will be reset to their default values. Do not run JumpStart after you have configured the system through programming.

To run JumpStart:

1. Enter the installer code.
2. Press  or  to display the main menu.
3. Select  for Program Menu.
Display reads: Initializing
 Please wait . . .
4. Select  for System Options.
5. Press the  or  arrow to select "Yes" from the warning screen.
6. Press .



7.9 Computer Account

An installer at the panel site can initiate communications between the panel and a computer running the 5660 SKSS (see also Section 8.5.16). In order for this communication to function properly both the computer (running the software) and the control panel must have matching computer account numbers and computer access codes.





Before you program in this location you should know how your control panel will communicate with the downloading computer, either through direct connect (RS232) or via the phone lines (Internal Modem).

If the panel initiates the call to a downloading computer, a phone number must be programmed in the computer accounts area. If the computer initiates the call, answering machine bypass may need to be selected (see Section 7.7.2.7).

To program computer account information:

1. Enter the installer code.
2. Press  or  to display the main menu.
3. Select  for Program Menu.

Display reads: Initializing
 Please wait . . .

4. Select  for System Options.
5. Enter the computer account number, then press .
6. Enter the computer code (up to 7-digits), then press .
7. Enter the phone number the panel will dial to connect to a downloading computer (up to 40-digits), then press . See Table 7-7 for special dialing characters.

7.10 Access Codes

Access codes provide the user access to the control panel functions. Each access code can be customized for each user. This allows some users the ability to access programming and other higher level panel functions, while other users may only need access to lower level functions such as performing fire drills, or acknowledging trouble conditions.

Profile 1 is the profile that dictates what functions the Fire Fighter Key has access to. Because this is the profile for a key the user name and the access code can not be edited for this profile.



Profile 2 is the profile for the installer and is referred to as the "Installer Code". This profile's user name and panel functions can not be edited.

Table 7-8 lists the panel functions that can be selected for each user profile.

Table 7-8: User Profile Selectable Panel Functions

Type of Function	Selectable Functions
Panel Operations	System Reset
	System Silence
	System Event Acknowledge
	Fire Drill Key
Panel Menus	System Test
	Fire Drill Menu
	Indicator Test
	Walk Test no Report
	Walk Test with Report
	Dialer Test
	Clear History Buffer
	Point Functions
	Disable/Enable Point
	Point Status
	Set SLC Device Address
	SLC Device Locator
	SLC Multi-Device Locator
	I/O Point Control
	Event History
	Set Time & Date
	Printer Options
	Event Logging
	Print Event History
	Print Detector Status
	Print System Configuration
	Reset Dialer
	Program Menu
	System Information
Upload/Download	

To change an access code:

1. Enter the installer code.
2. Press  or  to display the main menu.
3. Select  for Program Menu.

Display reads: Initializing

Please wait . . .

4. Select **[8]** for System Options.

Display reads: Select Profile 01
 Fire Fighter's Key

5. Select the access code you wish to edit by pressing the **▲** or **▼** arrow.
6. Then press **ENTER**.

7.10.1 Profile Edit Menu

From the Profile Edit Menu you can change the users name, access code, and the panel functions that the user will have access to with their code.

Note: Profile 1 (Fire Fighter's Key) the user name and access code can not be edited. Profile 2 (Installer) the user name and panel functions can not be edited.

7.10.1.1 Edit Name

7. Select each character of a word by pressing the **▲** or **▼** arrow, then press **▶** to move to the next character.
8. Repeat step 7 until user name is complete.
9. Then press **ENTER** to finish.

7.10.1.2 Edit Access Code

10. Enter new access code (minimum of 4 digits, maximum of 7 digit)
11. Press **ENTER**.
12. Enter code again.
13. Press **ENTER**.

7.10.1.3 Panel Functions

14. Press the **▲** or **▼** arrow to move through the list of available functions.
15. Then press **▶** to move to Y (yes) or N (no) selection column.
16. Press the **▲** or **▼** arrow to select Y or N.
17. Press **ENTER**.
18. Repeat steps 14 through 17 until user profile is complete.

Section 8

System Operation

Operation of the control panel is simple. Menus guide you step-by-step through operations. This section of the manual is an overview of the operation menus. Please read this entire section carefully before operating the panel.

Press **ENTER** to view Main Menu: Select the desired menu option. Enter your access code if prompted.

Note: See Section 7.10 for information on how to modify user access code profiles.

8.1 User and Installer Default Codes

User Code (factory-programmed as 1111).

Installer Code (factory-programmed as 5820).

8.2 Annunciator Description

Figure 8-1 shows the annunciator that is part of the control panel board assembly. Five LEDs indicate system status.

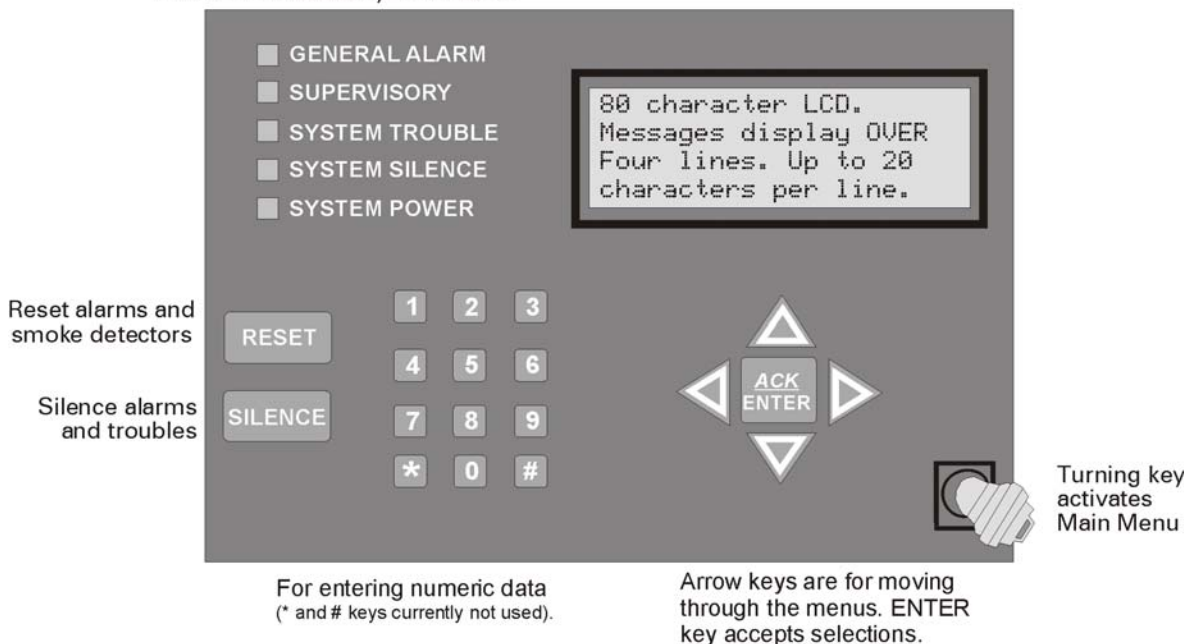

Figure 8-1 Control Panel Annunciator

8.2.1 LCD Displays

The control panel LCD displays system messages, annunciates alarms, supervisories and troubles; provides status information; and prompts for input. These messages can be up to 80 characters, displaying over four lines of 20 characters each. Annunciator keys beep when they are pressed.

8.2.2 Banner

The banner is the message that displays on the control panel when the system is in normal mode (no alarm or trouble condition exists and menus are not in use). You can create a customized message that will display instead of the internal (default) message. See Section 7.7.7 for information on customizing the banner.

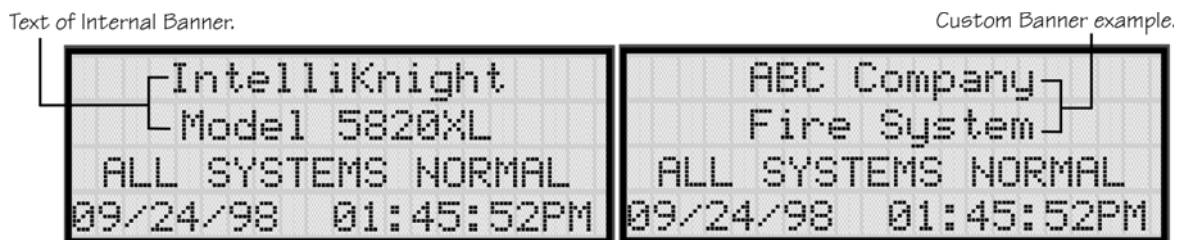

Figure 8-2 Banner Display Examples

8.3 Key Operation

The key on the control panel board assembly is for accessing the Main Menu. The key is activated when it is turned once to the right (clockwise). If the key has been used to activate the menu, it must be turned counter-clockwise to exit the menu.

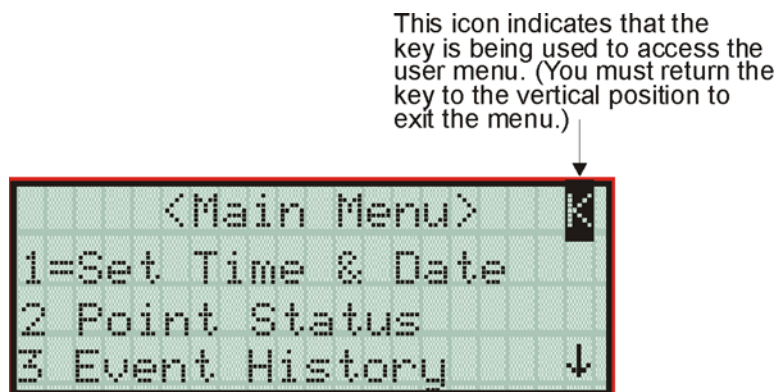



Figure 8-3 Using a Key to Access the Main Menu

8.4 Menu System

The control panel is easy to operate from Main Menu. To view the Main Menu press the  or  button on the control panel or remote annunciator, then turn the firefighter's key clockwise or enter your access code. The Main Menu will appear as shown in Section 8.4.1. Select the desired option. If you have entered a code or firefighter's key does not have access to the menu item you have selected the following display message will appear:

```
-Access denied.-
Entered PIN does not
allow access to this
function.
```

You must enter an access code with the correct profile settings to gain access to that menu item.

The control panel supports up to 20 access codes. The profile for each access code (or user) can be modified through the programming menu option (see Section 7.10 for access code programming).

8.4.1 Main Menu Overview

The chart below is a brief overview of the Main Menu. These options are described in greater detail throughout this section of the manual.

Main Menu Options	Description
1 System Tests	From here both menus can access Fire Drill and Indicator Test.
2 Point Functions	From here both menus can enable / disable points.
3 Event History	Display event history on the LCD. See Section 8.5.4 for more information.
4 Set Time and Date	Set time and date for the system.
5 Printer Options	Options for controlling a printer if attached to the system. If a printer is used, the Model 5824 serial/parallel interface module must be used.
6 Reset Dialer	Cancel any attempt to call the central station. Any calls awaiting additional attempts will be aborted.
7 Program Menu	Brings up a set of menus for programming the panel, including changing access codes. These options are described in detail in Section 7.
8 System Info	View system information, including model and serial numbers and revision number and date.
9 Up/Download	Initiate communication from the panel site between the panel and a computer running the Silent Knight Software Suite.

8.4.2 Using the Menus

To move through the menus:	Use ▼ and ▲ to move through the options in a menu. Use ← to move to a previous menu.
To select an option:	Enter the number of the option. -OR- Press ENTER (Enter key) if the option appears at the top of the menu (= symbol displays after the option number in this case).

8.5 Basic Operation

8.5.1 Setting Time and Date

1. From the Main Menu, select **4** for Set Date and Time.
2. Make changes in the fields on the screen. Use ► (right arrow) to move through the fields. Use the ▼ and ▲ to select options in the fields.
3. When the date and time are correct, press **ENTER**.

8.5.2 Disable / Enable a Point

1. From the Main Menu, select **2** for Point Functions.
2. Select **1** for Disable/Enable Point. A list of modules displays.
3. Use ▼ and ▲ to move through the list. Press **ENTER** to select the module where the point you want to disable/enable is located. A description of the point should display. The fourth line of the screen should show "NORMAL" (meaning that the point is currently enabled) or "DISABLED" (the point is currently disabled). Press ← to toggle between NORMAL and DISABLE.

8.5.3 Disable / Enable NACs by Group

1. From the Main Menu, select **2** for point functions.
2. Select **1** to Disable NACs by group or **2** to Enable NACs by group.
3. Use ▼ and ▲ to move through the list of groups. Press **ENTER** to select the group highlighted.

8.5.4 View Event History

Use the View Event History feature to display events on LCD. From the Main Menu, press **[3]** to select Event History. Events will begin displaying with most recent events first.

The panel can store up to 1000 events. When it reaches its 1000-event capacity, it begins deleting, starting with the oldest events.

If a printer is attached to the system (via a Module 5824 serial/parallel interface module), you can print event history (see Section 8.5.17).

The 5660 SKSS or 5670 SKSS can be used to retain more than 1000 events and to create event history reports.

8.5.4.1 To clear the event history

From the Installer menu select **[1]** for System Tests. From the test menu select **[6]** Clear History Buffer.

8.5.5 Conduct a Fire Drill

1. From the Main Menu, press **[1]** for System Tests.
2. Press **[1]** for Fire Drill. You will be prompted to press **[ENTER]**.
3. The drill will begin immediately after you press **[ENTER]**.
4. Press any key to end the drill. (If you do not press any key to end the fire drill manually, it will time out automatically after ten minutes.)

If a fire drill switch has been installed, activating the switch will begin the drill; deactivating the switch will end the drill.

8.5.6 Conduct an Indicator Test

The indicator test checks the annunciator LEDs, PZT, and LCD display.

1. From the Main Menu, press **[1]** for System Tests.
2. Press **[2]** for Indicator Test. The system turns on each LED several times, beeping the PZT as it does so. At the same time it scrolls each available character across the LCD. A problem is indicated if any of the following occurs:
 - An LED does not turn on;
 - You do not hear a beep;
 - All four lines of the LCD are not full.

This test takes approximately 15 seconds to complete. You can press any key to end manually while the test is still in progress. When the test ends, you will be returned to the <Test Menu>.

8.5.7 Conduct a Walk Test

1. From the Main Menu, press **[1]** for System Tests.

If any alarm verification zones are being used, the user will be asked if they wish to disable alarm verification during walk test. This occurs for either walk test option.

2. Select **[3]** for Walk Test-No Rpt. The LCD will display “WALK TEST STOPPED” on Line 1 and “ENTER = start test” on Line 2. If you select this option, central station reporting will be disabled while the test is in progress.

Or

Select **[4]** for Walk Test-with Rpt. The LCD will display “WALK TEST STOPPED” on Line 1 and “ENTER = start test” on Line 2. If you select this option, central station reporting will occur as normal during the walk test.

The panel generates a TEST report to the central station when the walk test begins. During a walk test, the panel’s normal fire alarm function is completely disabled, placing the panel in a local trouble condition. All zones respond as 1-Count zones (respond when a single detector is in alarm) during a walk test. Each alarm initiated during the walk test will be reported and stored in the event history buffer.

3. Press **[ENTER]** to end the walk test. The system will reset. The panel will send a "TEST RESTORE" report to the central station.

If you do not end the walk test manually within four hours, it will end automatically.

If an alarm or pre-alarm condition is occurring in the system, you will not be able to enter the walk test.

Note: the panel does not do a full 30 second reset on resettable power outputs. As soon as the device is back to normal, the panel is ready to go to the next device.

8.5.8 Conduct a Dialer Test

1. From the Main Menu, press **[1]** for System Tests.
2. Select **[5]** for Dialer Test. The screen will display “Manual dialer test started”. When the test is completed, you will be returned to the <Test Menu>.

8.5.9 Silence alarms or troubles

Press **SILENCE** and enter your code or rotate the key at the prompt. If an external silence switch has been installed, activating the switch will silence alarms or troubles. If you are already using system menus when you press **SILENCE**, you will not need to enter your code or rotate the key.

Note: Alarm and trouble signals that have been silenced but the detector remains un-restored will un-silence every 24 hours until it is restored.

8.5.10 Reset alarms

Press **RESET** and enter your code or rotate the key at the prompt. If an external reset switch has been installed, activating the switch will reset alarms. If you are already using system menus when you press **RESET**, you will not need to enter your code or rotate the key.

8.5.11 Check Detector Through Point Status

The control panel constantly monitors smoke detectors to ensure that sensitivity levels are in compliance with NFPA 72.

If sensitivity for a detector is not in compliance, the panel goes into trouble, generating a CAL TRBLE condition. A detector enters a CAL MAINT state to indicate that it is approaching an out of compliance condition (but is currently still in compliance).

When a CAL TRBLE condition occurs, the central station receives a detector trouble report (“373” + Zone # for Contact ID format; “FT” + Zone # in SIA format).

To check sensitivity for an individual detector, follow the steps below. Section 8.5.17 provides instructions for printing the status of all detectors in the system.

1. From the Main Menu, press **2** for Point Functions.
2. Press **2** for Point Status.
3. Select the module where the point you want to check is located.
4. Enter the number of the point you want to check and press **ENTER**.

5. A screen similar to those shown in Figure 8-4 will display.

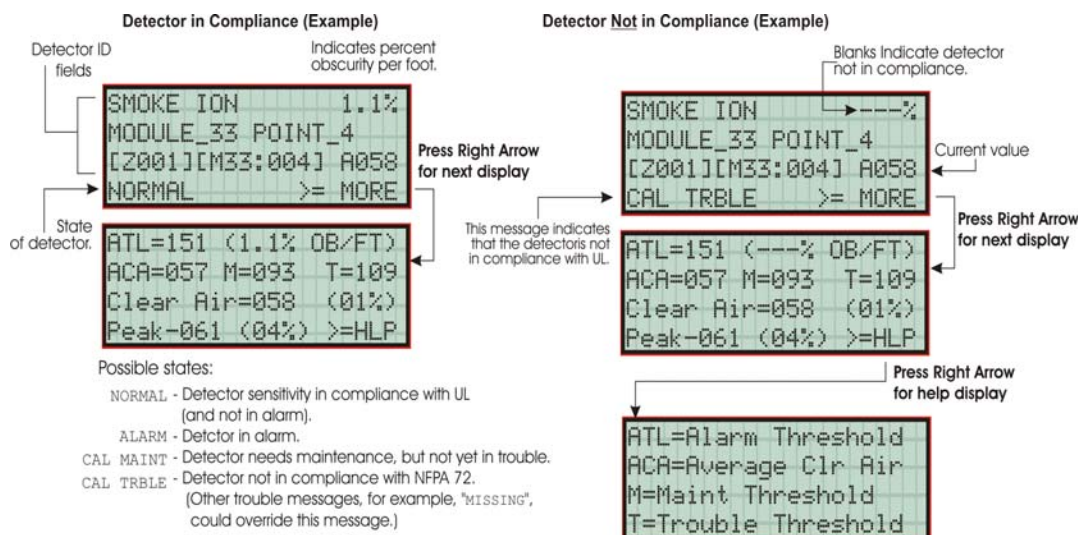

Figure 8-4 Checking Detector Sensitivity Compliance

If a printer is attached to the system (via a Module 5824 serial/parallel interface module), you can print detector status (see Section 8.5.17).

8.5.12 View Status of a Point

1. From the Main Menu, select **2** for Point Status.
2. From the list that displays, press **ENTER** to select the module where this point is located. The screen that displays will show you if the point has a trouble and will provide sensitivity compliance information. (See Section 8.5.11 for complete information about detector sensitivity compliance.)

8.5.13 View Alarms or Troubles

When the system is in alarm or trouble, you can press **▽** to view the location of an alarm or trouble. See Section 8.5.13 for more information.

8.5.14 View System Information

Press **8** from the Main Menu to view the panel model and serial number and system version number and date. The information displays for several seconds then returns to the main menu.

8.5.15 Reset dialer

From the Main Menu, select **6**. The LCD will display "Dialer reset in progress..." You will be returned to the Main Menu when the reset is completed.

8.5.16 Communicating with a Remote Computer

An installer at the panel site can initiate communications between the panel and a computer running the SKSS 5660. You can use this feature to upload a panel configuration. For example, if you have made programming changes to an installation on site using an annunciator, you can send your changes to the computer, so that the central station will have the latest data about the installation. See the software manual for more information (PN 151240).

To initiate communication:

1. From the Main Menu, select **9** for Up/Download.
2. From the next screen that displays, select the communication device. Options are:

1 = Internal Modem

If you select this option, you will use the panel's built-in modem to call the panel.

2 = RS232 connection

If you select this option, the panel and a computer are both on-site connected via a 9-pin **straight-through** serial cable.

3. If you are using the panel's internal modem to communicate, you will be prompted to enter a phone number. If you are communicating via the RS232 connection, a phone number is not needed and this step will be skipped.

If the phone number you will be calling is already displayed, press **ENTER**. Continue with Step 4.

If the phone number you will be calling is not already displayed, enter the number and press **ENTER**. A phone number can be up to 40 digits long and can contain the following special characters.

#	Pound (or number) key on the telephone
*	Star key on the telephone
,	Comma (character for 2-second pause)

Use the number buttons on the annunciator or the up- and down-arrow keys to select special characters. Characters begin displaying after "9".

4. You will be prompted to enter an account number. If the account number you want to use is already displayed, just press **ENTER** to begin communication.

If the account number displayed is not the correct one, enter the account number and press **ENTER** to begin communication.

5. The panel will attempt to communicate with the computer. If communication was established, the upload task you created will be placed in the SKSS 5660 job queue, awaiting processing. When processing is completed, an "Unsolicited Upload" task will appear in the queue.

8.5.17 Working with a Printer

If you are using the Model 5824 serial/parallel interface module, several printing options are available. See Section 4.7 for information about installing the 5824.

1. From the Main Menu, select **[5]** Printer Options.
2. From the next screen, select the 5824 module where the printer is connected.
3. If the printer is not currently busy printing another report, a screen with the following options will be available. If the printer is busy, a message will display. You can press **[1]** to cancel the current print job. These options will then display.

[1] = Event Logging

Enables event logging, which causes the printer to continuously print events as they occur. The date/time will print in 24-hour military format. Once event logging is enabled, it will remain enabled until canceled by the installer. If you need to disable event logging, return to this option and press **[1]** to disable.

Sample Event Log

```

EVENT LOG:                                     STARTED: 02/17/97 02:23
02/17/97 11:23 Event: System Silenced
02/17/97 11:24 Event: System Reset
02/17/97 14:30 Event: Local Programming Begin
02/17/97 15:01 Event: Local Programming Ended Successfully
EVENT LOG:                                     STOPPED: 02/17/97 15:02
    
```

[2] = Print Event History

Prints the up-to-1000 events currently stored in the panel's event history buffer. Events print starting with the newest. The date and time printed will be when the event actually occurred and will print in 24-hour military format.

Sample Event History Print-Out

```

EVENT HISTORY:                                PRINTED: 02/28/97 13:35
02/20/97 09:02 Event 3 of 10: System Silenced
02/20/97 09:05 Event 2 of 10: System Reset
02/22/97 08:47 Event 4 of 10: Printer Off Line 4
02/22/97 08:52 Event 4 of 10: Printer On Line 4
02/25/97 15:54 Event 5 of 10: Local Programming Begin
02/25/97 16:10 Event 5 of 10: Local Programming Ended Successfully
02/28/97 12:50 Event 6 of 10: Walk Test Begin
02/28/97 13:31 Event 2 of 10: Walk Test End
:
:
    
```

[3] = Print Detector Status

Prints the current status of all detectors in the system. This is a method for finding out if any detectors are out of NFPA compliance or any detectors need maintenance (are approaching an out of compliance condition).

Sample Detector Status Print-Out

```

DETECTOR STATUS:                                PRINTED: 06/09/98 13:45
NFFA72 Compliant
Peak Percent Alarm
Peak Clear Air
Current Percent Alarm
Clear Air Value
Trouble Threshold
Maintenance Threshold
Average Clear Air
Alarm Threshold Level
Sensitivity %ob/ft or deg E
Zone Number
ID NAME      TYPE  ZN  SENS  ATL  ACA  MT  TT  CAV  %A  PCA  %A  STATUS
-----
Module 33
063 MODULE_33 POINT_3  PHOTO  1  ---  240 141  83  94 140  0 141  0  CAL TRBL  N
065 MODULE_33 POINT_65  HEAT   1  150  150  0  N/A N/A  73  48  73  48  NORMAL  Y
066 MODULE_33 POINT_66  HEAT   1  150  150  0  N/A N/A  73  48  73  48  NORMAL  Y
067 MODULE_33 POINT_67  HEAT   1  150  150  0  N/A N/A  73  48  73  48  NORMAL  Y
068 MODULE_33 POINT_68  HEAT   1  150  150  0  N/A N/A  73  48  73  48  NORMAL  Y
    
```

Note: Detector status can also be viewed and printed using the 5660 SKSS or 5670 SKSS (facility monitoring only).

8.6 Operation Mode Behavior

The control panel can be in one of seven conditions at any given moment: Normal, Alarm, Prealarm, Supervisory, Trouble, Silenced, and Reset. Table 8-1 describes the behavior of the panel in each of these modes.

Table 8-1: Operation Mode Behavior

Operation Mode	Occurs When	System Behavior	In This Mode You Can
Normal	No alarm or trouble condition exists and menus are not in use.	<p>SYSTEM POWER LED is on.</p> <p>The All Systems Normal display indicates that the system is in normal mode.</p>  <p>The current date and time display on the last line of the LCD.</p>	Enter the appropriate code to activate the User or Installer Menu, or rotate the key to activate the User Menu.
Alarm	A smoke detector goes into alarm or a pull station is activated.	<p>The dialer seizes control of the phone line and calls the central station.</p> <p>The on-board annunciator sounds a loud, steady beep (any notification devices attached to the system will also sound).</p> <p>GENERAL ALARM LED flashes.</p> <p>The LCD displays a screen similar to this one.</p> <p>Count of alarms in the system In this example there are 5.</p>  <p>Press the down arrow to view the type and location of alarm. (Message alternates with the date/time display.)</p>	<p>Press the down arrow to view the alarm. A screen similar to this one displays.</p>  <p>Module and Point name Device type</p> <p>Zone name</p> <p>Shows which event is currently being displayed. In this example, there are 5 alarms, the third is being displayed.</p> <p>Press SILENCE and enter an access code (or activate the key) to silence the annunciator (and any notification devices attached to the system).</p> <p>When the alarm condition clears, press RESET and enter a code (or activate the key) to restore the panel to normal.</p>

Table 8-1: Operation Mode Behavior

Operation Mode	Occurs When	System Behavior	In This Mode You Can
Supervisory	The system detects a supervisory condition.	<p>The dialer seizes control of the phone line and calls the central station.</p> <p>The on-board annunciator sounds a loud, pulsing beep in the sequence one second on, one second off.</p> <p>SUPERVISORY LED flashes.</p> <p>The LCD displays a screen similar to this one.</p> <p>Count of supervisorys in the system In this example there is 1.</p> <div data-bbox="526 663 911 831" style="border: 1px solid black; padding: 5px; text-align: center;"> <p>SUPERVSY cnt[1]</p> <p>Press ↓ for status</p> </div> <p>Press the down arrow to view the type and location of alarm. (Message alternates with the date/time display.)</p>	<p>Press ▼ (down arrow) to view the supervisory condition. A screen similar to this one displays.</p> <div data-bbox="964 394 1386 596" style="border: 1px solid black; padding: 5px;"> <p>Module and Point name Device type</p> <p>SUPERVSY: MAN_PULL</p> <p>MODULE_33 POINT_2</p> <p>ZONE_2</p> <p style="text-align: right;">1 of 1</p> </div> <p>Zone name Shows which event is currently being displayed.</p> <p>Press [SILENCE] and enter an access code (or activate the key) to silence the annunciator.</p> <p>Once the supervisory condition has been corrected, the system will restore itself automatically.</p>
Trouble	A system trouble condition occurs.	<p>The dialer seizes control of the phone line and calls the central station.</p> <p>The on-board annunciator sounds a loud, pulsing beep in the sequence one second on, nine seconds off.</p> <p>SYSTEM TROUBLE LED flashes.</p> <p>The LCD displays a screen similar to this one.</p> <p>Count of troubles in the system In this example there are 3.</p> <div data-bbox="537 1247 894 1398" style="border: 1px solid black; padding: 5px; text-align: center;"> <p>TROUBLE cnt[3]</p> <p>Press ↓ for status</p> </div> <p>Press the down arrow to view the type and location of trouble condition. (This message alternates with the date / time display.)</p>	<p>Press ▼ (down arrow) to view the trouble. A screen similar to this one displays.</p> <div data-bbox="959 1016 1409 1226" style="border: 1px solid black; padding: 5px;"> <p>Module and Point name Device type</p> <p>TROUBLE SMOKE-PHOTO</p> <p>MODULE_33 POINT_1</p> <p>Zone # [Z02] [M33:001]</p> <p style="text-align: center;">Module # Point #</p> <p>MISSING 1 of 3</p> </div> <p>Type of trouble. In this example, the panel does not see a detector that should be on the loop. Shows which event is currently being displayed. In this example, there are 3 troubles, 1 is being displayed.</p> <p>Press [SILENCE] and enter an access code (or activate the key) to silence the annunciator.</p> <p>Once the trouble condition has been fixed, the system will restore itself automatically.</p>

Table 8-1: Operation Mode Behavior

Operation Mode	Occurs When	System Behavior	In This Mode You Can
<p>Prealarm</p>	<p>A single detector trips in a 2-Count zone. (2-Count means two detectors must trip before an alarm is reported.)</p>	<p>Touchpad PZT beeps. The LCD displays a screen similar to this one.</p> <p style="text-align: center;">Count of alarms in the system In this example there is 1.</p> <div style="border: 1px solid black; padding: 5px; width: fit-content; margin: 10px auto;"> <p>PREALARM cnt[1]</p> <p>Press ↓ for status</p> </div> <p>Press the down arrow to view the type and location of prealarm. (Message alternates with the date/time display.)</p>	<p>Press ▼ (down arrow) to view the prealarm. A screen similar to this one displays.</p> <div style="display: flex; justify-content: space-around; font-size: small;"> Module and Point name Device type </div> <div style="border: 1px solid black; padding: 5px; width: fit-content; margin: 10px auto;"> <p>PREALARM: SMOKE- PHOTO</p> <p>MODULE_33 POINT_2</p> <p>ZONE_2</p> <p style="text-align: right;">1 of 1</p> </div> <div style="display: flex; justify-content: space-around; font-size: small;"> Zone name Shows which event is currently being displayed. </div> <p>All system operations are available in this mode.</p>
<p>Reset</p>	<p>The RESET button is pressed followed by a valid code or rotation of the key.</p>	<p>All LEDs are on briefly then the LCD displays "ALARM RESET IN PROGRESS". If the reset process completes normally, the date and time normal mode screen displays.</p>	<p>Menus are not available during the reset process.</p>
<p>Silenced</p>	<p>An alarm or trouble condition has been silenced but still exists. To silence alarms and troubles, press SILENCE followed by the Installer or User Code or rotate the key.</p>	<p>SYSTEM SILENCE LED is on. SYSTEM TROUBLE, SUPERVISORY or GENERAL ALARM LED (depending on condition) is on. The annunciator (and any notification devices attached to the system) will be silenced.</p>	<p>Press ▼ (down arrow) to view the location of the alarm or trouble. When the condition no longer exists, the SYSTEM SILENCED and SYSTEM TROUBLE LED, SUPERVISORY or GENERAL ALARM LEDs turn off.</p>

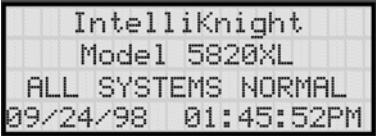
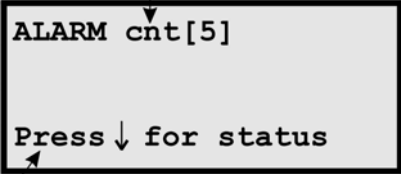
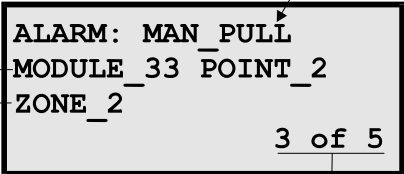
8.7 Releasing Operations

This control panel supports two types of releasing, Double Interlock Zone, and Single Interlock Zone. The Double Interlock Zone operation requires an interlock switch input in the system, and the Single Interlock does not. An interlock switch is typically a dry-contact pressure switch.

When a Single or Double Interlock Zone releasing is selected the system will automatically default the following system parameters:

Note: The defaults created can be modified through programming if desired.

- Output Group 2 is created. Output Group 2 will be defaulted as an "Alarm" output group for all releasing zones. NAC [34:001] is assigned to Output Group 2.
- Output Group 3 is created. Output Group 3 will be defaulted as an "Pre-Alert" output group for all releasing zones. NAC [34:002] is assigned to Output Group 3.
- Output Group 4 is created. Output Group 4 will be defaulted as a "Release" output group for all releasing zones. NAC circuit [34:003] is assigned to Output Group 4.

Note: The installer must define which input points will be used for detectors, manual release switches, or interlock/pressure switches.

Table 8-2: Approved Releasing Solenoids

Manufacturer	Part Number	Rating	Current	Freq
Asco	T8210A107	24 VDC	3A max	0 Hz
	8210G207	24 VDC	3A max	0 Hz

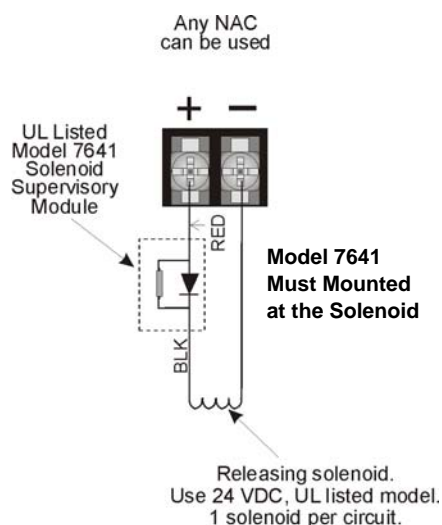

Figure 8-5 Wiring Configuration for Solenoid

Do not mix cross alarming zones with smoke verification zones. There must be at least two automatic detection devices in each protected space. Spacing must be reduced to 0.7 times the linear spacing in accordance with NFPA 72. See Section 7.4 for zone option programming.

8.7.1 Single Interlock Zone Releasing

A single interlock zone utilizes a minimum of two addressable detectors and a designated manual release switch.

Only addressable detectors can be used. No conventional detectors can be used.
Each Single Interlock Zone input requires at least one manual release switch.

Conditions Required for an Pre-Alert Output Activation

If any single addressable detector is activated, the “Pre-Alert” output will activate. This alerts the user that the initial stages required for a release condition are present. (Also refer to Table 8-3.)

Conditions required for an General Alarm and Release Output Activation

If two or more addressable detectors, or a manual release switch activate, the “Alarm” and the “Release” outputs will activate. (Also refer to Table 8-3.)

Table 8-3: Single Interlock Zone Operation

Inputs	Output Results							
	Normal	Pre-Alert	Pre-Alert	Release and General Alarm	Release and General Alarm	Release and General Alarm	Release and General Alarm	Release and General Alarm
1st Addressable Detector		✓		✓		✓		✓
2nd Addressable Detector			✓	✓			✓	✓
Manual Release Station					✓	✓	✓	✓

8.7.2 Double Interlock Zone Releasing

A Double Interlock Zone uses a minimum of two Addressable detectors, a designated manual release switch, and an interlock switch input. An interlock switch is typically a dry-contact pressure switch and will be referred to as an interlock/pressure switch in this document.

Only addressable detectors can be used. No conventional detectors can be used.
Each Single Interlock Zone input requires at least one manual release switch.
Each Double Interlock Zone input requires at least one Interlock/pressure switch

Conditions Required for a Pre-Alert Output Activation

If any single addressable detector is activated, the “Pre-Alert” output will activate. This alerts the user that the initial stages required for a release condition are present. (Also refer to Table 8-3.)

Conditions Required for a General Alarm Output Activation

If two addressable detectors, a manual release switch is activated, or an interlock switch is active, the "Pre-Alert", and "General Alarm" outputs will activate.

Conditions Required for a Release Output Activation

Any release requires the activation of an interlock switch, and either a manual release switch or 2 activated addressable detectors. When these conditions are met, the "Release" and "General Alarm" outputs will activate, and the "Alert" outputs will deactivate.

Table 8-4: Double Interlock Zone Operation

Inputs	Output Results																
	1	2	3	4	5	6	7	8	9	10	11	12	13	14	15		
1st Addressable Detector	✓			✓			✓		✓		✓		4		4		4
2nd Addressable Detector		✓	✓				✓	✓			✓		4			4	4
Manual Release Station					✓	✓	✓	✓						4	4	4	4
Interlock/Pressure Switch									✓	✓	✓		4	4	4	4	4
Normal																	
Pre-Alert																	
Pre-Alert																	
Pre-Alert and General Alarm																	
Pre-Alert and General Alarm																	
Pre-Alert and General Alarm																	
Pre-Alert and General Alarm																	
Pre-Alert and General Alarm																	
Pre-Alert and General Alarm																	
Pre-Alert and General Alarm																	
Pre-Alert and General Alarm																	
Release and General Alarm																	
Release and General Alarm																	
Release and General Alarm																	
Release and General Alarm																	
Release and General Alarm																	

8.8 Smoke Alarm Verification

Figure 8-6 illustrates how the Smoke Alarm Verification cycle operates.

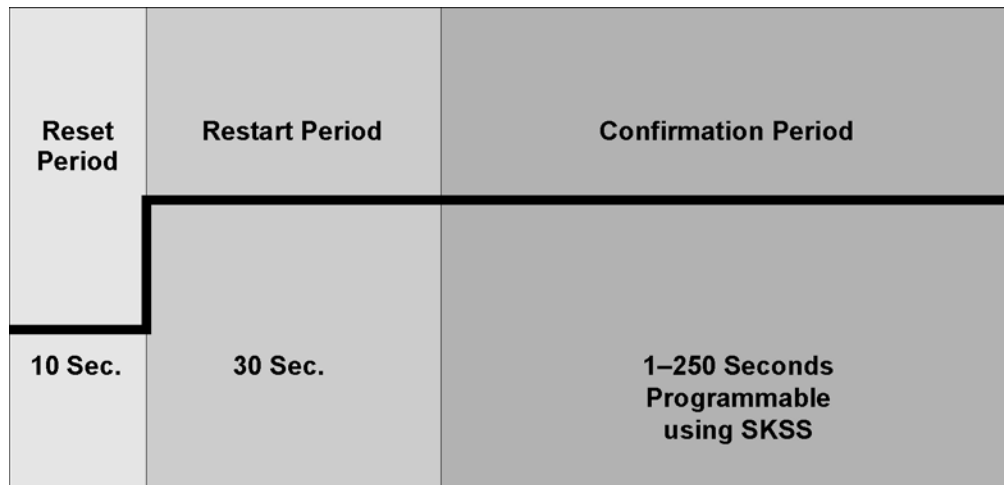

Figure 8-6 Smoke Verification Cycle

During the Confirmation Period if there is no alarm indication then the system will return to normal operation.

Section 9

Reporting

This section lists receivers that are compatible with this control panel, and the reporting codes sent by the control panel for SIA and Contact ID formats.

9.1 Receivers Compatible with the Control Panel

Table 9-1 shows receivers compatible with the control panel.

Table 9-1: Receivers Compatible with the Control Panel

Manufacturer	Model	Format
Silent Knight	Model 9800	SIA and Contact ID
	Model 9000 (SIA formats)	SIA
Ademco	Model 685 (Contact ID)	Contact ID
Sur-Gard	SG-MLR2-DG (V. 1.64 or higher)	SIA and Contact ID
Osborne Hoffman	Quickalert	SIA and Contact ID

9.2 Reporting Formats Dialer Outputs

Event Description	Event Family	Event Class (System, Zone, or Point)	SIA Reporting Format			Contact ID Reporting Format			
			Module ID # (if any)	SIA Event Code	Parameter (if any)	Qualifier	Event Code	Group #	Contact #
System Events	Note: System events are reported when either "Report by Point" or "Report by Zone" is selected.								
AC power restore	Trouble	System Event		AR		3	301	00	000
AC power lost	Trouble	System Event		AT		1	301	00	000
SBUS expander trouble restore	Trouble	System Event		ER	Exp. ID	3	333	00	Exp. ID
SBUS Class A supervision restore	Trouble	System Event		ER	Exp. ID	3	333	00	Exp. ID
Short circuit removed from SLC communication loop	Trouble	System Event		ER	Exp. ID	3	332	00	Exp. ID
SLC Class A supervision restored	Trouble	System Event		ER	Exp. ID	3	331	00	Exp. ID
SBUS expander trouble	Trouble	System Event		ET	Exp. ID	1	333	00	Exp. ID
SBUS Class A supervision lost	Trouble	System Event		ET	Exp. ID	1	333	00	Exp. ID
Short circuit detected on SLC communication loop	Trouble	System Event		ET	Exp. ID	1	332	00	Exp. ID
SLC Class A supervision lost	Trouble	System Event		ET	Exp. ID	1	331	00	Exp. ID
Fire drill has begun	Test	System Event		FI		1	604	00	000
Fire drill ended	Test	System Event		FK		3	604	00	000
Panel date has been changed	Trouble	System Event		JD		1	625	00	000

Event Description	Event Family	Event Class (System, Zone, or Point)	SIA Reporting Format			Contact ID Reporting Format			
			Module ID # (if any)	SIA Event Code	Parameter (if any)	Qualifier	Event Code	Group #	Contact #
Panel time has been changed	Trouble	System Event		JT		1	625	00	000
Local programming begin	Trouble	System Event		LB		1	627	00	000
Phone line 1 trouble restore	Trouble	System Event		LR	1	3	351	00	001
Phone line 2 trouble restore	Trouble	System Event		LR	2	3	352	00	002
Local programming ended normally	Trouble	System Event		LS		1	628	00	000
Phone line 1 trouble detected	Trouble	System Event		LT	1	1	351	00	001
Phone line 2 trouble detected	Trouble	System Event		LT	2	1	352	00	002
Local programming aborted or ended with errors	Trouble	System Event		LU		1	628	00	000
Periodic test event – normal	Test	System Event		RP		1	602	00	000
Periodic test event – off normal	Test	System Event		RY		1	608	00	000
Initial power up	Trouble	System Event		RR		1	305	00	000
Remote programming ended normally	Trouble	System Event		RS		1	412	00	000
Unable to report to an account	Trouble	System Event		RT	Acct #	1	354	Acct #	Acct #
Remote programming aborted or ended with errors	Trouble	System Event		RU		1	413	00	000
User has initiated dialer test	Test	System Event		RX		1	601	00	
Water release circuit has been disabled	Trouble	System Event	pi Exp. ID	SS	Pnt #	1	203	Exp. ID	Pnt #
Water release circuit has been re-enabled	Trouble	System Event	pi Exp. ID	SR	Pnt #	3	203	Exp. ID	Pnt #
Walk test end	Test	System Event		TE		3	607	00	000
SLC address programming ended; system has been re-enabled.	Test	System Event		TE		3	607	00	000
Walk test begin	Test	System Event		TS		1	607	00	000
SLC address programming started; system has been shut down.	Test	System Event		TS		1	607	00	000
Printer paper restore	Trouble	System Event		VI	Exp ID	3	335	00	Exp. ID
Printer is out of paper	Trouble	System Event		VO	Exp ID	1	335	00	Exp. ID
Printer back online	Trouble	System Event		VY	Exp ID	3	336	00	Exp. ID
Printer offline	Trouble	System Event		VZ	Exp ID	1	336	00	Exp. ID
Auto dialer test communication trouble	Trouble	System Event		YC	Line #	1	350	00	Line #
Report to an account successful	Trouble	System Event		YK	Acct #	3	354	Acct #	Acct #
Auto dialer test communication trouble restore	Trouble	System Event		YK	Line #	3	350	00	Line #
Ground fault condition detected	Trouble	System Event		YP	Exp. ID	1	310	00	Exp. ID
Ground fault condition restore	Trouble	System Event		YQ	Exp. ID	3	310	00	Exp. ID
Battery voltage restore	Trouble	System Event		YR	Exp. ID	3	302	00	Exp. ID
Battery voltage low	Trouble	System Event		YT	Exp. ID	1	302	00	Exp. ID
Zone Events	Note: Note: Zone events are reported only when "Report by Zone" is selected.								

Event Description	Event Family	Event Class (System, Zone, or Point)	SIA Reporting Format			Contact ID Reporting Format			
			Module ID # (if any)	SIA Event Code	Parameter (if any)	Qualifier	Event Code	Group #	Contact #
SLC LED Module trouble restore	Trouble	Zone Event		ER	0000	3	333	00	000
SLC LED Module trouble	Trouble	Zone Event		ET	0000	1	333	00	000
Manual pull switch alarm	Alarm	Zone Event		FA	Zone	1	115	00	Zone
Detector alarm	Alarm	Zone Event		FA	Zone	1	110	00	Zone
Manual pull switch alarm restore	Restore	Zone Event		FH	Zone	3	115	00	Zone
Detector alarm restore	Restore	Zone Event		FH	Zone	3	110	00	Zone
Manual pull switch trouble restore	Trouble	Zone Event		FJ	Zone	3	373	00	Zone
Detector trouble restore	Trouble	Zone Event		FJ	Zone	3	373	00	Zone
Positive Alarm Sequence acknowledge switch trouble restore	Trouble	Zone Event		FJ	Zone	3	373	00	Zone
Auxiliary power trouble restore	Trouble	Zone Event		FJ	0000	3	320	00	000
Notification output trouble restore	Trouble	Zone Event		FJ	1000+Group #	3	320	00	Group #
Manual pull switch trouble	Trouble	Zone Event		FT	Zone	1	373	00	Zone
Detector trouble	Trouble	Zone Event		FT	Zone	1	373	00	Zone
Positive Alarm Sequence acknowledge switch trouble	Trouble	Zone Event		FT	Zone	1	373	00	Zone
Auxiliary power trouble	Trouble	Zone Event		FT	0000	1	320	00	000
Notification trouble	Trouble	Zone Event		FT	1000+Group#	1	320	00	Group #
User initiated a system reset	Reset	Zone Event		OR		1	401	00	000
Water flow switch alarm	Alarm	Zone Event		SA	Zone	1	113	00	Zone
Water flow switch alarm restore	Restore	Zone Event		SH	Zone	3	113	00	Zone
Water flow switch trouble restore	Trouble	Zone Event		SJ	Zone	3	373	00	Zone
Supervisory/Tamper switch trouble restore	Trouble	Zone Event		SJ	Zone	3	373	00	Zone
Supervisory condition restore	Trouble	Zone Event		SR	Zone	3	203	00	Zone
Supervisory condition	Trouble	Zone Event		SS	Zone	1	203	00	Zone
Water flow switch trouble	Trouble	Zone Event		ST	Zone	1	373	00	Zone
Supervisory/Tamper switch trouble	Trouble	Zone Event		ST	Zone	1	373	00	Zone
Zone-based AUX1 switch alarm	Alarm	Zone Event		UA	1000+Zone	1	140	01	Zone
Zone-based AUX2 switch alarm	Alarm	Zone Event		UA	2000+Zone	1	140	02	Zone
System-based AUX1 switch alarm	Alarm	Zone Event		UA	1000	1	140	01	000
System-based AUX2 switch alarm	Alarm	Zone Event		UA	2000	1	140	02	000
Zone-based AUX1 switch alarm restore	Restore	Zone Event		UH	1000+Zone	3	140	01	Zone
Zone-based AUX2 switch alarm restore	Restore	Zone Event		UH	2000+Zone	3	140	02	Zone
System-based AUX1 switch alarm restore	Restore	Zone Event		UH	1000	3	140	01	000

Event Description	Event Family	Event Class (System, Zone, or Point)	SIA Reporting Format			Contact ID Reporting Format			
			Module ID # (if any)	SIA Event Code	Parameter (if any)	Qualifier	Event Code	Group #	Contact #
System-based AUX2 switch alarm restore	Restore	Zone Event		UH	2000	3	140	02	000
Zone-based AUX1 switch trouble restore	Trouble	Zone Event		UJ	1000+Zone	3	373	01	Zone
Zone-based AUX2 switch trouble restore	Trouble	Zone Event		UJ	2000+Zone	3	373	02	Zone
System-based AUX1 switch trouble restore	Trouble	Zone Event		UJ	1000	3	373	01	000
System-based AUX2 switch trouble restore	Trouble	Zone Event		UJ	2000	3	373	02	000
External Reset/Silence/Fire Drill switch trouble restore	Trouble	Zone Event		UJ	0000	3	373	00	000
Zone-based AUX1 switch trouble	Trouble	Zone Event		UT	1000+Zone	1	373	01	Zone
Zone-based AUX2 switch trouble	Trouble	Zone Event		UT	2000+Zone	1	373	02	Zone
System-based AUX1 switch trouble	Trouble	Zone Event		UT	1000	1	373	01	000
System-based AUX2 switch trouble	Trouble	Zone Event		UT	2000	1	373	02	000
External Reset/Silence/Fire Drill switch trouble	Trouble	Zone Event		UT	0000	1	373	00	000
Point Events	Note: Note: Point events are reported only when "Report by Point" is selected.								
Manual pull switch alarm	Alarm	Point Event	pi Exp. ID	FA	Pnt #	1	115	Exp. ID	Pnt #
Manual release switch alarm (Water Release Zone)	Alarm	Point Event	pi Exp. ID	FA	Pnt #	1	110	Exp. ID	Pnt #
Interlock switch alarm (Water Release Zone)	Alarm	Point Event	pi Exp. ID	FA	Pnt #	1	110	Exp. ID	Pnt #
Detector alarm	Alarm	Point Event	pi Exp. ID	FA	Pnt #	1	110	Exp. ID	Pnt #
Point disabled	Disable	Point Event	pi Exp. ID	FB	Pnt #	1	571	Exp. ID	Pnt #
Manual pull switch alarm restore	Restore	Point Event	pi Exp. ID	FH	Pnt #	3	115	Exp. ID	Pnt #
Manual release switch alarm restore (Water Release Zone)	Restore	Point Event	pi Exp. ID	FH	Pnt #	3	110	Exp. ID	Pnt #
Interlock switch alarm restore (Water Release Zone)	Restore	Point Event	pi Exp. ID	FH	Pnt #	3	110	Exp. ID	Pnt #
Detector alarm restore	Restore	Point Event	pi Exp. ID	FH	Pnt #	3	110	Exp. ID	Pnt #
Notification output trouble restore	Trouble	Point Event	pi Exp. ID	FJ	Pnt #	3	320	Exp. ID	Pnt #
Manual pull switch trouble restore	Trouble	Point Event	pi Exp. ID	FJ	Pnt #	3	373	Exp. ID	Pnt #
Manual release switch trouble restore (Water Release Zone)	Trouble	Point Event	pi Exp. ID	FJ	Pnt #	3	373	Exp. ID	Pnt #

Event Description	Event Family	Event Class (System, Zone, or Point)	SIA Reporting Format			Contact ID Reporting Format			
			Module ID # (if any)	SIA Event Code	Parameter (if any)	Qualifier	Event Code	Group #	Contact #
Interlock switch trouble restore (Water Release Zone)	Trouble	Point Event	pi Exp. ID	FJ	Pnt #	3	373	Exp. ID	Pnt #
Detector trouble restore	Trouble	Point Event	pi Exp. ID	FJ	Pnt #	3	373	Exp. ID	Pnt #
Positive Alarm Sequence acknowledge switch trouble restore	Trouble	Point Event	pi Exp. ID	FJ	Pnt #	3	373	Exp. ID	Pnt #
Aux power trouble restore	Trouble	Point Event	pi Exp. ID	FJ	Pnt #	3	320	Exp. ID	Pnt #
Notification output trouble	Trouble	Point Event	pi Exp. ID	FT	Pnt #	1	320	Exp. ID	Pnt #
Manual pull switch trouble	Trouble	Point Event	pi Exp. ID	FT	Pnt #	1	373	Exp. ID	Pnt #
Manual release switch trouble (Water Release Zone)	Trouble	Point Event	pi Exp. ID	FT	Pnt #	1	373	Exp. ID	Pnt #
Interlock switch trouble (Water Release Zone)	Trouble	Point Event	pi Exp. ID	FT	Pnt #	1	373	Exp. ID	Pnt #
Detector trouble	Trouble	Point Event	pi Exp. ID	FT	Pnt #	1	373	Exp. ID	Pnt #
Positive Alarm Sequence acknowledge switch trouble	Trouble	Point Event	pi Exp. ID	FT	Pnt #	1	373	Exp. ID	Pnt #
Auxiliary Power Trouble	Trouble	Point Event	pi Exp. ID	FT	Pnt #	1	320	Exp. ID	Pnt #
Point Enabled	Disable	Point Event	pi Exp. ID	FU	Pnt #	3	571	Exp. ID	Pnt #
Water flow switch alarm	Alarm	Point Event	pi Exp. ID	SA	Pnt #	1	113	Exp. ID	Pnt #
Water flow switch disabled	Disable	Point Event	pi Exp. ID	SB	Pnt #	1	571	Exp. ID	Pnt #
Supervisory/Tamper switch or supervisory duct detector disabled	Disable	Point Event	pi Exp. ID	SB	Pnt #	1	571	Exp. ID	Pnt #
Water flow switch alarm restore	Restore	Point Event	pi Exp. ID	SH	Pnt #	3	113	Exp. ID	Pnt #
Water flow switch trouble restore	Trouble	Point Event	pi Exp. ID	SJ	Pnt #	3	373	Exp. ID	Pnt #
Supervisory/Tamper switch or supervisory duct detector trouble restore	Trouble	Point Event	pi Exp. ID	SJ	Pnt #	3	373	Exp. ID	Pnt #
Supervisory condition restore	Trouble	Point Event	pi Exp. ID	SR	Pnt #	3	203	Exp. ID	Pnt #
Supervisory condition	Trouble	Point Event	pi Exp. ID	SS	Pnt #	1	203	Exp. ID	Pnt #
Water flow switch trouble	Trouble	Point Event	pi Exp. ID	ST	Pnt #	1	373	Exp. ID	Pnt #
Supervisory/Tamper switch or supervisory duct detector trouble	Trouble	Point Event	pi Exp. ID	ST	Pnt #	1	373	Exp. ID	Pnt #

Event Description	Event Family	Event Class (System, Zone, or Point)	SIA Reporting Format			Contact ID Reporting Format			
			Module ID # (if any)	SIA Event Code	Parameter (if any)	Qualifier	Event Code	Group #	Contact #
Water flow switch re-enabled	Disable	Point Event	pi Exp. ID	SU	Pnt #	3	571	Exp. ID	Pnt #
Supervisory/Tamper switch or supervisory duct dectector re-enabled	Disable	Point Event	pi Exp. ID	SU	Pnt #	3	571	Exp. ID	Pnt #
Zone-based AUX1 switch alarm	Alarm	Point Event	pi Exp. ID	UA	Pnt #	1	140	Exp. ID	Pnt #
Zone-based AUX2 switch alarm	Alarm	Point Event	pi Exp. ID	UA	Pnt #	1	140	Exp. ID	Pnt #
System-based AUX1 switch alarm	Alarm	Point Event	pi Exp. ID	UA	Pnt #	1	140	Exp. ID	Pnt #
System-based AUX2 switch alarm	Alarm	Point Event	pi Exp. ID	UA	Pnt #	1	140	Exp. ID	Pnt #
Auxiliary switch input disabled	Disable	Point Event	pi Exp. ID	UB	Pnt #	1	571	Exp. ID	Pnt #
Zone-based AUX1 switch alarm restore	Restore	Point Event	pi Exp. ID	UH	Pnt #	3	140	Exp. ID	Pnt #
Zone-based AUX2 switch alarm restore	Restore	Point Event	pi Exp. ID	UH	Pnt #	3	140	Exp. ID	Pnt #
System-based AUX1 switch alarm restore	Restore	Point Event	pi Exp. ID	UH	Pnt #	3	140	Exp. ID	Pnt #
System-based AUX2 switch alarm restore	Restore	Point Event	pi Exp. ID	UH	Pnt #	3	140	Exp. ID	Pnt #
Zone-based AUX1 switch trouble restore	Trouble	Point Event	pi Exp. ID	UJ	Pnt #	3	373	Exp. ID	Pnt #
Zone-based AUX2 switch trouble restore	Trouble	Point Event	pi Exp. ID	UJ	Pnt #	3	373	Exp. ID	Pnt #
External Reset/Silence/Fire Drill switch trouble restore	Trouble	Point Event	pi Exp. ID	UJ	Pnt #	3	373	Exp. ID	Pnt #
System-based AUX1 switch trouble restore	Trouble	Point Event	pi Exp. ID	UJ	Pnt #	3	373	Exp. ID	Pnt #
System-based AUX2 switch trouble restore	Trouble	Point Event	pi Exp. ID	UJ	Pnt #	3	373	Exp. ID	Pnt #
Zone-based AUX1 switch trouble	Trouble	Point Event	pi Exp. ID	UT	Pnt #	1	373	Exp. ID	Pnt #
Zone-based AUX2 switch trouble	Trouble	Point Event	pi Exp. ID	UT	Pnt #	1	373	Exp. ID	Pnt #
External Reset/Silence/Fire Drill switch trouble	Trouble	Point Event	pi Exp. ID	UT	Pnt #	1	373	Exp. ID	Pnt #
System-based AUX1 switch trouble	Trouble	Point Event	pi Exp. ID	UT	Pnt #	1	373	Exp. ID	Pnt #
System-based AUX2 switch trouble	Trouble	Point Event	pi Exp. ID	UT	Pnt #	1	373	Exp. ID	Pnt #
Auxiliary switch input re-enabled	Disable	Point Event	pi Exp. ID	UU	Pnt #	3	571	Exp. ID	Pnt #
An unexpected SLC device has been detected	Trouble	Point Event	pi Exp. ID	XE	Pnt #	1	380	Exp. ID	Pnt #

Event Description	Event Family	Event Class (System, Zone, or Point)	SIA Reporting Format			Contact ID Reporting Format			
			Module ID # (if any)	SIA Event Code	Parameter (if any)	Qualifier	Event Code	Group #	Contact #
An unexpected SLC device has been removed	Trouble	Point Event	pi Exp. ID	XI	Pnt #	3	380	Exp. ID	Pnt #

Section 10

Testing and Troubleshooting

10.1 Troubleshooting

This section of the manual offers suggestions for troubleshooting hardware problems. Please read this section if you encounter a problem when installing the control panel. If these suggestions do not solve your problem or if you encounter a problem that is not listed here, contact Silent Knight Technical Support at 800-446-6444 for assistance.

10.2 Common Problems

Problem	Possible Cause / Suggested Actions
Trouble message "DBL ADDR" (Double Address) displays on LCD.	An address has been assigned to more than one detector. Correct the address following the procedure described in Section 5.8.
Auxiliary power or notification circuits have incorrect polarity.	Correct polarity. For notification and auxiliary power circuits: When in alarm or powered, terminals labeled "X" are positive, terminals labeled "O" are negative.
SLC devices are not being recognized (trouble message "Missing" displays).	Check hardware connections. If devices are physically connected, make sure wiring is correct (see Section 5.4). For the main panel, the positive side of device must be connected to terminal 34; the negative side must be connected to Terminal 33. For 5815XL devices, make sure the device connects to the 5815XL via the SLC OUT terminals. There can be only one SLC loop on the main panel and on each 5815XL module. Do not connect devices to terminals labeled SLC IN.
	Make sure SLC devices have been addressed properly following the procedure described in Section 5.8. For contact monitor modules, which are addressed using dip switches, the dip switch must be set to the correct address before power is applied to the SLC loop. If this procedure is not followed, the device will have an incorrect address.
	Make sure correct polarity has been observed for SLC device wiring. See Section 5.4.

Problem	Possible Cause / Suggested Actions
SLC devices are not being recognized (trouble message "Missing" displays on the annunciator).	<p>Check that SLC loop impedance is within the required range. To measure impedance, use the following procedure.</p> <ol style="list-style-type: none"> 1. Disconnect both wires from the terminal block at the panel (SLC devices can remain connected). 2. Measure the impedance from positive to negative and from negative to positive. Both measurements should be greater than 500 K ohms. If the installation uses T-taps, test each T-tap individually. 3. Temporarily connect the positive wire to the negative wire of the SLC loop at the point farthest from the panel (SLC devices can remain connected). 4. Measure the impedance from positive to negative and from negative to positive. Both measurements must be less than 50 ohms.
The panel indicates a ground fault trouble condition (trouble message "GROUND FAULT" displays).	<p>An earth ground fault occurs when the panel senses an unexpected flow of current from one or more of its terminals to the earth connection (Terminal 2). Isolate the wiring that is causing the fault by removing wiring connections one at a time until the earth fault is no longer present. Pause at least five seconds after removing a wire before removing the next one.</p> <p>The panel will also go into ground fault if a computer is connected to the panel via a serial cable attached to the panel's 9-pin connector. This is a correct method for on-site communication between a panel and a computer. Ignore the ground fault message in this case. The trouble will clear automatically when you disconnect the computer from the cable</p>
5815XL module that has been physically connected to the panel but is not being recognized.	<p>Check the status of the 5815XL green LED. If it flashes in the pattern .5 sec. on / .5 sec. off, it is likely that the 5815XL has not been added to the system through programming. JumpStart will add any 5815XLs connected to the panel. If you have already run JumpStart, 5815XLs can be added manually (see Section 7.3.2).</p> <p>Check that the correct ID for the 5815XL module has been set through the DIP switches. Assign ID#1 to the first 5815XL and ID#2 to the second 5815XL. See Section 4.10.1 for complete details.</p> <p>If the wiring between the 5815XL and the panel is correct, measure the voltage from 5815XL Terminal (+) to Terminal (-). Voltage should be in the range 27.2-27.4V when AC power is present.</p> <p>If the green LED is not flashing, the likely cause is incorrect wiring from between the 5815XL and the panel. See Section 4.6.1 for wiring details.</p>

10.2.1 Periodic Testing And Maintenance

To ensure proper and reliable operation, it is recommended that system inspection and testing be scheduled monthly or as required by national and/or local fire codes. Testing should be done by a qualified services representative if a malfunction is encountered.

Before testing:

- 1) Notify the fire department and/or central alarm receiving station if an alarm condition is transmitted.
- 2) Notify facility personnel of a test so that alarm sounding devices are ignored during the test period.

3) When necessary, activation of Notification Appliances can be prevented by the DISABLE function

Testing:

1) Activate a input via an alarm initiating device and check that the correct outputs activate (Notification Appliances sound/flash, relays activate, alarm LED lights). Reset system.

Repeat for each alarm initiating device.

2) Momentarily open the following circuits one at a time and check for a trouble signal:

- Notification Appliance (bell) Circuits.
- Initiating devices

3) If new batteries were installed, wait 48 hours before completing this step. Remove AC power, activate initiating device and check that:

- The ALARM indicator lights.
- All active Notification Appliances sound.

Measure battery voltage while the Notification Appliances are sounding. Replace any battery with terminal voltage less than 85% of rating. Reapply AC power and RESET system.

10.2.2 Event History

The event history can be useful for tracking or recalling a trouble condition.

10.3 Built-in Troubleshooting and Testing Tools

The fire control panel has several built-in testing and troubleshooting tools that can be utilized to save time while testing and troubleshooting points and SLC devices.

10.3.1 SLC Device Locator

SLC device locator can be used to locate a device on a SLC loop.

Follow these steps to locate a particular SLC device:

1. Select (Point Functions) from the Main Menu.
2. Select (SLC Dev Locator).

A message similar to the one shown in Figure 10-1 will display.

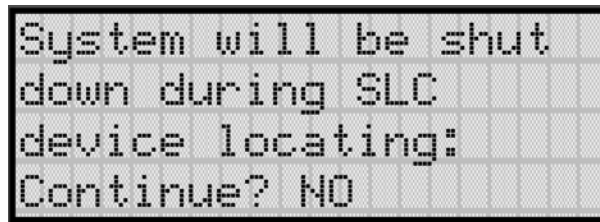

Figure 10-1 Shut Down Warning

3. Press the or arrow to toggle NO to YES then press .

If NO is chosen you will exit back to the Point Function menu.

If YES is chosen the system will cease normal operation leaving the premise unprotected.

4. Select the SLC loop.
5. Enter the SLC address of the device you wish to locate.

The LED on the selected device will start flashing.

6. Press any key to exit SLC device locator function.

Note: Once you exit the system will resume normal operation.

10.3.2 SLC Multi Locator

This feature is the same as SLC Device Locator, except you can locate up to 8 devices on a single search.

Follow these instructions to locate multiple SLC devices:

1. Select **[2]** (Point Functions) from the Main Menu.
2. Select **[5]** (SLC Dev Locator).

A message similar to the one shown in Figure 10-1 will display.

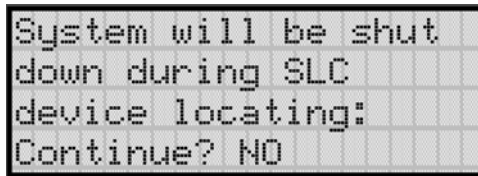

```

System will be shut
down during SLC
device locating:
Continue? NO
  
```

Figure 10-2 Shut Down Warning

3. Press the **▲** or **▼** arrow to toggle **NO** to **YES** then press **ENTER**.

If **NO** is chosen you will exit back to the Point Function menu.

If **Yes** is chosen the system will cease normal operation leaving the premise unprotected.

4. Select the SLC loop.
5. Enter up to 8 SLC addresses for the devices you wish to locate.

The LEDs on the selected devices will start flashing.







6. Press the **◀** to exit SLC multi-locator function.

Note: Once you exit the system will resume normal operation.

10.3.3 I/O Point Control

This feature allows you to toggle any output on or off and trip any input device. This can be useful to test a point's output mapping.

Follow these steps to control a I/O point:

1. Select  (Point Functions) from the Main Menu.
2. Select  (I/O Point Control).
3. Select the Module the point is on.
4. Enter the zone number , or press the  or  arrow to select the point you wish to test, then press .
5. Press  to generate an alarm for an input point or activate an output point.
6. To exit press .

10.3.4 Earth Fault Resistance

Table 10-1 lists the earth fault resistance detection for each applicable terminal on the FACP.

Table 10-1: Earth Fault Resistance Values by Terminal

Function	Terminal Number	Terminal Label		Low Biased		High Biased	
		(Values in Ohms)		High Trip	High Restore	Low Trip	Low Restore
Flexput™ Notification Circuits	4	X	I/O 6	-	-	0	0
	5	O		0	0	-	-
	6	X	I/O 5	-	-	0	0
	7	O		0	0	-	-
	8	X	I/O 4	-	-	0	0
	9	O		0	0	-	-
	10	X	I/O 3	-	-	0	0
	11	O		0	0	-	-
	12	X	I/O 2	-	-	0	0
	13	O		0	0	-	-
	14	X	I/O 1	-	-	0	0
	15	O		0	0	-	-
SBUS Communication	16	B	SBUS OUT	-	-	0	0
	17	A		-	-	0	0
SBUS Power	18	+		0	0	-	-
	19	-		-	-	0	0
SBUS Communication	20	B	SBUS IN	-	-	0	0
	21	A		-	-	0	0
SBUS Power	22	+		0	0	-	-
	23	-		-	-	0	0
SLC Terminals	33	SC-	SLC OUT	-	-	0	0
	34	S+		0	0	-	-
	35	SC-	SLC IN	-	-	0	0
	36	S+		0	0	-	-

Section 11

Installation Records

This section of the manual is for you to use if you wish to track of how points, zones, and groups have been programmed.

11.1 SLC Point Record

You can use the chart that begins below to keep track of SLC points.

Default addresses for ID: On-board: = 33
 5815-1: = 1
 5815-2: = 2
 5815-3 = 3

Table 11-1: Installation Record

Module	Addr	Zone / Group	Description	Module	Addr	Zone/ Group	Description
On-board	1			On-board	25		
On-board	2			On-board	26		
On-board	3			On-board	27		
On-board	4			On-board	28		
On-board	5			On-board	29		
On-board	6			On-board	30		
On-board	7			On-board	31		
On-board	8			On-board	32		
On-board	9			On-board	33		
On-board	10			On-board	34		
On-board	11			On-board	35		
On-board	12			On-board	36		
On-board	13			On-board	37		
On-board	14			On-board	38		
On-board	15			On-board	39		
On-board	16			On-board	40		
On-board	17			On-board	41		
On-board	18			On-board	42		
On-board	19			On-board	43		
On-board	20			On-board	44		
On-board	21			On-board	45		
On-board	22			On-board	46		
On-board	23			On-board	47		
On-board	24			On-board	48		

Table 11-1: Installation Record

Module	Addr	Zone / Group	Description	Module	Addr	Zone/ Group	Description
On-board	49			On-board	89		
On-board	50			On-board	90		
On-board	51			On-board	91		
On-board	52			On-board	92		
On-board	53			On-board	93		
On-board	54			On-board	94		
On-board	55			On-board	95		
On-board	56			On-board	96		
On-board	57			On-board	97		
On-board	58			On-board	98		
On-board	59			On-board	99		
On-board	60			On-board	100		
On-board	61			On-board	101		
On-board	62			On-board	102		
On-board	63			On-board	103		
On-board	64			On-board	104		
On-board	65			On-board	105		
On-board	66			On-board	106		
On-board	67			On-board	107		
On-board	68			On-board	108		
On-board	69			On-board	109		
On-board	70			On-board	110		
On-board	71			On-board	111		
On-board	72			On-board	112		
On-board	73			On-board	113		
On-board	74			On-board	114		
On-board	75			On-board	115		
On-board	76			On-board	116		
On-board	77			On-board	117		
On-board	78			On-board	118		
On-board	79			On-board	119		
On-board	80			On-board	120		
On-board	81			On-board	121		
On-board	82			On-board	122		
On-board	83			On-board	123		
On-board	84			On-board	124		
On-board	85			On-board	125		
On-board	86			On-board	126		
On-board	87			On-board	127		
On-board	88						

Table 11-1: Installation Record

Module	Addr	Zone / Group	Description	Module	Addr	Zone/ Group	Description
5815-1	1			5815-1	42		
5815-1	2			5815-1	43		
5815-1	3			5815-1	44		
5815-1	4			5815-1	45		
5815-1	5			5815-1	46		
5815-1	6			5815-1	47		
5815-1	7			5815-1	48		
5815-1	8			5815-1	49		
5815-1	9			5815-1	50		
5815-1	10			5815-1	51		
5815-1	11			5815-1	52		
5815-1	12			5815-1	53		
5815-1	13			5815-1	54		
5815-1	14			5815-1	55		
5815-1	15			5815-1	56		
5815-1	16			5815-1	57		
5815-1	17			5815-1	58		
5815-1	18			5815-1	59		
5815-1	19			5815-1	60		
5815-1	20			5815-1	61		
5815-1	21			5815-1	62		
5815-1	22			5815-1	63		
5815-1	23			5815-1	64		
5815-1	24			5815-1	65		
5815-1	25			5815-1	66		
5815-1	26			5815-1	67		
5815-1	27			5815-1	68		
5815-1	28			5815-1	69		
5815-1	29			5815-1	70		
5815-1	30			5815-1	71		
5815-1	31			5815-1	72		
5815-1	32			5815-1	73		
5815-1	33			5815-1	74		
5815-1	34			5815-1	75		
5815-1	35			5815-1	76		
5815-1	36			5815-1	77		
5815-1	37			5815-1	78		
5815-1	38			5815-1	79		
5815-1	39			5815-1	80		
5815-1	40			5815-1	81		
5815-1	41			5815-1	82		

Table 11-1: Installation Record

Module	Addr	Zone / Group	Description	Module	Addr	Zone/ Group	Description
5815-1	83			5815-1	123		
5815-1	84			5815-1	124		
5815-1	85			5815-1	125		
5815-1	86			5815-1	126		
5815-1	87			5815-1	127		
5815-1	88						
5815-1	89			5815-2	1		
5815-1	90			5815-2	2		
5815-1	91			5815-2	3		
5815-1	92			5815-2	4		
5815-1	93			5815-2	5		
5815-1	94			5815-2	6		
5815-1	95			5815-2	7		
5815-1	96			5815-2	8		
5815-1	97			5815-2	9		
5815-1	98			5815-2	10		
5815-1	99			5815-2	11		
5815-1	100			5815-2	12		
5815-1	101			5815-2	13		
5815-1	102			5815-2	14		
5815-1	103			5815-2	15		
5815-1	104			5815-2	16		
5815-1	105			5815-2	17		
5815-1	106			5815-2	18		
5815-1	107			5815-2	19		
5815-1	108			5815-2	20		
5815-1	109			5815-2	21		
5815-1	110			5815-2	22		
5815-1	111			5815-2	23		
5815-1	112			5815-2	24		
5815-1	113			5815-2	25		
5815-1	114			5815-2	26		
5815-1	115			5815-2	27		
5815-1	116			5815-2	28		
5815-1	117			5815-2	29		
5815-1	118			5815-2	30		
5815-1	119			5815-2	31		
5815-1	120			5815-2	32		
5815-1	121			5815-2	33		
5815-1	122			5815-2	34		

Table 11-1: Installation Record

Module	Addr	Zone / Group	Description	Module	Addr	Zone/ Group	Description
5815-2	35			5815-2	75		
5815-2	36			5815-2	76		
5815-2	37			5815-2	77		
5815-2	38			5815-2	78		
5815-2	39			5815-2	79		
5815-2	40			5815-2	80		
5815-2	41			5815-2	81		
5815-2	42			5815-2	82		
5815-2	43			5815-2	83		
5815-2	44			5815-2	84		
5815-2	45			5815-2	85		
5815-2	46			5815-2	86		
5815-2	47			5815-2	87		
5815-2	48			5815-2	88		
5815-2	49			5815-2	89		
5815-2	50			5815-2	90		
5815-2	51			5815-2	91		
5815-2	52			5815-2	92		
5815-2	53			5815-2	93		
5815-2	54			5815-2	94		
5815-2	55			5815-2	95		
5815-2	56			5815-2	96		
5815-2	57			5815-2	97		
5815-2	58			5815-2	98		
5815-2	59			5815-2	99		
5815-2	60			5815-2	100		
5815-2	61			5815-2	101		
5815-2	62			5815-2	102		
5815-2	63			5815-2	103		
5815-2	64			5815-2	104		
5815-2	65			5815-2	105		
5815-2	66			5815-2	106		
5815-2	67			5815-2	107		
5815-2	68			5815-2	108		
5815-2	69			5815-2	109		
5815-2	70			5815-2	110		
5815-2	71			5815-2	111		
5815-2	72			5815-2	112		
5815-2	73			5815-2	113		
5815-2	74			5815-2	114		

Table 11-1: Installation Record

Module	Addr	Zone / Group	Description	Module	Addr	Zone/ Group	Description
5815-2	115			5815-3	28		
5815-2	116			5815-3	29		
5815-2	117			5815-3	30		
5815-2	118			5815-3	31		
5815-2	119			5815-3	32		
5815-2	120			5815-3	33		
5815-2	122			5815-3	34		
5815-2	123			5815-3	35		
5815-2	124			5815-3	36		
5815-2	125			5815-3	37		
5815-2	126			5815-3	38		
5815-2	127			5815-3	39		
				5815-3	40		
5815-3	1			5815-3	41		
5815-3	2			5815-3	42		
5815-3	3			5815-3	43		
5815-3	4			5815-3	44		
5815-3	5			5815-3	45		
5815-3	6			5815-3	46		
5815-3	7			5815-3	47		
5815-3	8			5815-3	48		
5815-3	9			5815-3	49		
5815-3	10			5815-3	50		
5815-3	11			5815-3	51		
5815-3	12			5815-3	52		
5815-3	13			5815-3	53		
5815-3	14			5815-3	54		
5815-3	15			5815-3	55		
5815-3	16			5815-3	56		
5815-3	17			5815-3	57		
5815-3	18			5815-3	58		
5815-3	19			5815-3	59		
5815-3	20			5815-3	60		
5815-3	21			5815-3	61		
5815-3	22			5815-3	62		
5815-3	23			5815-3	63		
5815-3	24			5815-3	64		
5815-3	25			5815-3	65		
5815-3	26			5815-3	66		
5815-3	27			5815-3	67		

Table 11-1: Installation Record

Module	Addr	Zone / Group	Description	Module	Addr	Zone/ Group	Description
5815-3	68			5815-3	98		
5815-3	69			5815-3	99		
5815-3	70			5815-3	100		
5815-3	71			5815-3	101		
5815-3	72			5815-3	102		
5815-3	73			5815-3	103		
5815-3	74			5815-3	104		
5815-3	75			5815-3	105		
5815-3	76			5815-3	106		
5815-3	77			5815-3	107		
5815-3	78			5815-3	108		
5815-3	79			5815-3	109		
5815-3	80			5815-3	110		
5815-3	81			5815-3	111		
5815-3	82			5815-3	112		
5815-3	83			5815-3	113		
5815-3	84			5815-3	114		
5815-3	85			5815-3	115		
5815-3	86			5815-3	116		
5815-3	87			5815-3	117		
5815-3	88			5815-3	118		
5815-3	89			5815-3	119		
5815-3	90			5815-3	120		
5815-3	91			5815-3	121		
5815-3	92			5815-1	122		
5815-3	93			5815-3	123		
5815-3	94			5815-3	124		
5815-3	95			5815-3	125		
5815-3	96			5815-3	126		
5815-3	97			5815-3	127		

Copy these pages if you additional sheets.

11.2 Conventional Output Point Record

This chart can be used to keep track of how conventional output points (circuits) have been configured.

Point/Circuit	Group	Description
1		
2		
3		
4		
5		
6		
7		
8		

Appendix A

Compatible Devices

A.1 Notification Appliances

For proper operation, you must use polarized devices with a Model 7628 4.7k ohm EOL resistor on each loop. All supervised notification appliances used with the control panel must be polarized.

Note: Not all devices can use the Sync feature, be sure to check Table A-1 to ensure the device you have chosen will work with this feature. This control is UL listed for panel wide Synchronization.

Table A-1 below lists notification appliances compatible with the fire alarm control panel. Appliances which can be synchronized indicate the type of sync available in the columns marked Audio and/or Visual.

Table A-1: Compatible Notification Appliances

Manufacturer	Model	Audio	Visual	Type
AMSECO	SH24W-153075	✓	✓	Horn/Strobe
	SAD24-153075		✓	Strobe
	SAD24-75110		✓	Strobe
	SL24W-75110		✓	Strobe
	SL24C-3075110		✓	Strobe
	SLB24-75		✓	Strobe
	RSD24-153075		✓	Strobe
	RSD24-75110		✓	Strobe
	SH24W-75110	✓	✓	Horn/Strobe
	SH24W-3075110	✓	✓	Horn/Strobe
	SHB24-75	✓	✓	Horn/Strobe
	SCM24W-153075	✓		Chimes/Strobe
	SCM24W-75110	✓		Chimes/Strobe
	SCM24C-3075110	✓		Chimes/Strobe
	SCM24C-177	✓		Chimes/Strobe
	H24W	✓		Horn
	H24R	✓		Horn

Table A-1: Compatible Notification Appliances

Manufacturer	Model	Audio	Visual	Type
Faraday	446			Vibrating Bell
	476			Vibrating Bell
	477			Single Stroke Bell
	2700 -M, -R, -T, -Y, -Z			Strobe
	2701 Series			Strobe
	2705 Series			Strobe
	2820	✓	✓	Sync Temporal Horn/Strobe
	2821	✓	✓	Sync Temporal Horn/Strobe
	2824	✓	✓	Horn Strobe
	5333			Multi-Tone Horn)
	5336			Multi-Tone Horn/Strobe
	5337			Multi-Tone Horn/Strobe
	5338			Multi-Tone Horn/Strobe
	5343			Single Tone Horn/Strobe
	5346			Electronic Horn with Strobe
	5347			Electronic Horn with Strobe
	5348			Single Tone Horn/Strobe
	5373			8-Tone Horn/Strobe
	6321			Sync Mini Horn/Strobe
	6322			Mini Horn/Sync Strobe
	6380			8-Tone Electronic Signal/Strobe
	5376			8-Tone Horn/Strobe
	5377			8-Tone Horn/Strobe
	5378			8-Tone Horn/Strobe
	5383			8-Tone Horn/Strobe with Sync Strobe
	5386			8-Tone Horn/Strobe with Sync Strobe
	5387			8-Tone Horn/Strobe with Sync Strobe
	5388			8-Tone Horn/Strobe with Sync Strobe
	5508			Single Gang Sync Strobe
	5509			Strobe

Table A-1: Compatible Notification Appliances

Manufacturer	Model	Audio	Visual	Type
Faraday	5510			Strobe
	5511			Strobe
	5512			Strobe
	5516			Strobe
	5517			Strobe
	5518			Strobe
	5519			Strobe
	5521			4" Square Sync Strobe
	5522			4" Square Sync Strobe
	6120			Horn
	6140			Horn
	6223			Horn
	6226			Horn/Strobe
	6227			Horn/Strobe
	6228			Horn/Strobe
	6243			Electron-Mechanical Horn
	6244			Electron-Mechanical Horn
	6245			Electron-Mechanical Horn
	6246			Electron-Mechanical Horn/Strobe
	6247			Electron-Mechanical Horn/Strobe
	6248			Electron-Mechanical Horn/Strobe
	6300			Mini-Horn
	6301			Mini-Horn
	6302			Mini-Horn
	6310			Mini-Horn/Strobe
	6311			Mini-Horn/Strobe
	6312			Mini-Horn/Strobe
	6314 Series -M, -R, -T, -Y, -Z			Strobe
	6320			Sync Mini Horn/Strobe

Table A-1: Compatible Notification Appliances

Manufacturer	Model	Audio	Visual	Type
FCI	S2415-FC			Strobe
	S241575-FC			Strobe
	S2430-FC			Strobe
	I30-3117C			Mini Horn
	I30-3147C			Mini Horn
	BLV-6			Vibrating Bell
	BLV-10			Vibrating Bell
	BLVCH			Vibrating Chime
	H12/24-FC			Horn
	H12/24W-FC			Horn
	H12/24K-FC			Horn
	HC12/24-FC			Horn
	HC12/24W-FC			Horn
	HC12/24K-FC			Horn
FCI	P2415-FC			Horn/Strobe
	P2415W-FC			Horn/Strobe
	P2415K-FC			Horn/Strobe
	P241575-FC			Horn/Strobe
	P241575W-FC			Horn/Strobe
	P241575F-FC			Horn/Strobe
	P241575K-FC			Horn/Strobe
	P2430-FC			Horn/Strobe
	P2430W-FC			Horn/Strobe
	P2430K-FC			Horn/Strobe
	P2475-FC			Horn/Strobe
	P2475W-FC			Horn/Strobe
	P2475K-FC			Horn/Strobe
	P24110-FC			Horn/Strobe
	P24110W-FC			Horn/Strobe
	P24110K-FC			Horn/Strobe
	S2430W-FC			Strobe
	S2430K-FC			Strobe
	S2475-FC			Strobe
	S2475W-FC			Strobe
	S2475K-FC			Strobe
	S24110-FC			Strobe
	S24110W-FC			Strobe
S24110K-FC			Strobe	
Federal Signal	450			Horn
	VALS			Horn/Strobe

Table A-1: Compatible Notification Appliances

Manufacturer	Model	Audio	Visual	Type
Gentex	GEC-24-15	✓	✓	Horn/Strobes
	GEC-24-30	✓	✓	Horn/Strobes
	GEC-24-60	✓	✓	Horn/Strobes
	GEC-24-75	✓	✓	Horn/Strobes
	GEC-24-177	✓	✓	Horn/Strobes
	GEC-24-110	✓	✓	Horn/Strobe
	GEC-24-15/75	✓	✓	Horn/Strobe
	GX91	✓		MiniHorn Steady Tone
	GX93	✓		MiniHorn Temporal Tone
Gentex	HG124			Horn
	HS24-15	✓	✓	Horn/Strobe
	HS24-30	✓	✓	Horn/Strobe
	HS24-60	✓	✓	Horn/Strobe
	HS24-75	✓	✓	Horn/Strobe
	HS24-110	✓	✓	Horn/Strobe
	HS24-1575	✓	✓	Horn/Strobe
	GCC24	✓	✓	Multi Candella Horn/Strobe Ceiling Mount
	GCCR24	✓	✓	Multi Candella Horn/Strobe Ceiling Mount
	GCS24		✓	Multi Candella Strobe Ceiling Mount
	GCSR24		✓	Multi Candella Strobe Ceiling Mount
	GEGR-24	✓	✓	Multi Candella Horn/Strobe
	GES24-15		✓	Strobes
	GES24-30		✓	Strobes
	GES24-60		✓	Strobes
	GES24-75		✓	Strobes
	GES24-110		✓	Strobes
	GES24-15/75		✓	Strobes
	GES24-177		✓	Strobes
	GES3-24		✓	Multi Candella Strobe
	GESR-24		✓	Multi Candella Strobe
	GEH-24	✓		Horn
	ST24-30		✓	Strobe
	ST24-60		✓	Strobe
	ST24-75		✓	Strobe
	ST24-110		✓	Strobe
	ST24-1575		✓	Strobe
	WGEC24-75W	✓	✓	Weatherproof Horn/Strobe
	WGES24-75W		✓	Weatherproof Strobe
	WGMS-24-X			Horn/Strobe

Table A-1: Compatible Notification Appliances

Manufacturer	Model	Audio	Visual	Type
System Sensor	CHR	✓		Chime
	CHW	✓		Chime
	CHSR	✓	✓	2-Wire Chime/Strobe
	CHSW	✓	✓	2-Wire Chime/Strobe
	HR	✓	✓	Horn
	HW		✓	Horn
	HRK		✓	Horn
	P2R	✓	✓	2-Wire Horn/Strobe
	P2R-P	✓	✓	2-Wire Horn/Strobe
	PC2R	✓	✓	2-Wire Horn/Strobe
	PC2R-P	✓	✓	2-Wire Horn/Strobe
	P2RH	✓	✓	2-Wire Horn/Strobe High Candela
	P2RH-P	✓	✓	2-Wire Horn/Strobe High Candela
	PC2RH	✓	✓	2-Wire Horn/Strobe High Candela
	PC2RH-P	✓	✓	2-Wire Horn/Strobe High Candela
	P2W	✓	✓	2-Wire Horn/Strobe
	P2W-P	✓	✓	2-Wire Horn/Strobe
	PC2W	✓	✓	2-Wire Horn/Strobe
	PC2W-P	✓	✓	2-Wire Horn/Strobe
	P2WH	✓	✓	2-Wire Horn/Strobe High Candela
	P2WH-P	✓	✓	2-Wire Horn/Strobe High Candela
	PC2WH	✓	✓	2-Wire Horn/Strobe High Candela
	PC2WH-P	✓	✓	2-Wire Horn/Strobe High Candela
	P2RK	✓	✓	2-Wire Horn/Strobe
	PC2RK	✓	✓	2-Wire Horn/Strobe
	P2RHK	✓	✓	2-Wire Horn/Strobe High Candela
	PC2RHK	✓	✓	2-Wire Horn/Strobe High Candela
	P4R	✓	✓	4-Wire Horn/Strobe
	PC4R	✓	✓	4-Wire Horn/Strobe
	P4RH	✓	✓	4-Wire Horn/Strobe High Candela
P4W	✓	✓	4-Wire Horn/Strobe	

Table A-1: Compatible Notification Appliances

Manufacturer	Model	Audio	Visual	Type	
System Sensor	PC4W	✓	✓	4-Wire Horn/Strobe	
	P4WH	✓	✓	4-Wire Horn/Strobe High Candela	
	PC4WH	✓	✓	4-Wire Horn/Strobe High Candela	
	P4RK	✓	✓	4-Wire Horn/Strobe	
	PC4RK	✓	✓	4-Wire Horn/Strobe	
	P4RHK	✓	✓	4-Wire Horn/Strobe High Candela	
	PC4RHK	✓	✓	4-Wire Horn/Strobe High Candela	
	PC4RH	✓	✓	4-Wire Horn/Strobe High Candela	
	SR			✓	Strobe
	SR-P			✓	Strobe
	SCR			✓	Strobe
	SCR-P			✓	Strobe
	SRH			✓	Strobe High Candela
	SRH-P			✓	Strobe High Candela
	SCRH			✓	Strobe High Candela
	SCRH-P			✓	Strobe High Candela
	SW			✓	Strobe
	SW-P			✓	Strobe
	SCW			✓	Strobe
	SCW-P			✓	Strobe
	SWH			✓	Strobe High Candela
	SWH-P			✓	Strobe High Candela
	SCWH			✓	Strobe High Candela
	SCWH-P			✓	Strobe High Candela
	SRK			✓	Strobe
	SCRK			✓	Strobe
	SRHK			✓	Strobe High Candela
	SCRHK			✓	Strobe High Candela

Table A-1: Compatible Notification Appliances

Manufacturer	Model	Audio	Visual	Type
Wheelock	AH-12	✓		Horn
	AH-24	✓		Horn
	AH-12WP	✓		Horn Weatherproof
	AH-24WP	✓		Horn Weatherproof
	AMT-241575W	✓	✓	Multi-Tone Horn Strobe
	AMT-24MCW		✓	Multi-Tone Horn Strobe
	AMT-241575W-NYC	✓	✓	Multi-Tone Horn Strobe
	AMT-12/24	✓		Multi-tone Horn
	AMT-12/24 NYC	✓		Multi-tone Horn
	AS-121575W		✓	Horn/Strobe
	NH-12/24	✓		Horn
	AS-241575W	✓	✓	Horn/Strobe
	AS-24MCC	✓	✓	Horn/Strobe
	AS-24MCCH	✓	✓	Horn/Strobe
	AS-24MCW	✓	✓	Horn/Strobe
	AS-24MCWH	✓	✓	Horn/Strobe
	ASWP-2475W	✓	✓	Horn/Strobe Weatherproof
	ASWP-2475C	✓	✓	Horn/Strobe Weatherproof
	ASWP-24MCWH	✓	✓	Horn/Strobe
	ASWP-24MCCH	✓	✓	Horn/Strobe
	CH-70	✓		Chime
	CH-90	✓		Chime
	CH70-241575W		✓	Chime/Strobe
	CH70-24MCW		✓	Chime/Strobe
	CH70-24MCWH		✓	Chime/Strobe
	CH90-24MCC		✓	Chime/Strobe

Table A-1: Compatible Notification Appliances

Manufacturer	Model	Audio	Visual	Type
Wheelock	CH90-24MCCH		✓	Chime/Strobe
Con't	HS-24	✓		Horn
	HS4-241575W	✓	✓	Horn/Strobe
	HS4-24MCW	✓	✓	Horn/Strobe
	HS4-24MCWH	✓	✓	Horn/Strobe
	HS4-24MCC	✓	✓	Horn/Strobe
	MIZ-24S	✓	✓	Mini Horn Strobe
	MT-121575W		✓	MultitoneHorn Strobe
	MT-241575W	✓	✓	Multitone Horn Strobe
	MT-24MCW		✓	Multitone Horn Strobe
	MTWP-2475W		✓	Multitone Horn Strobe
	MTWP-2475C		✓	Multitone Horn Strobe
	MTG-121575W	✓	✓	Multitone Horn Strobe
	MTR-121575W	✓	✓	Multitone Horn Strobe
	MTWPA-2475W	✓	✓	Multitone Horn Strobe
	MTWPB-2475W	✓	✓	Multitone Horn Strobe
	MTWPG-2475W	✓	✓	Multitone Horn Strobe
	MTWPR-2475W	✓	✓	Multitone Horn Strobe
	MTWPA-24MCCH	✓	✓	Multitone Horn Strobe
	ZNH	✓		Horn
	NS-121575W	✓	✓	Horn/Strobe
	NS-241575W	✓	✓	Horn/Strobe
	NS-24MCW	✓	✓	Horn/Strobe
	NS-24MCC	✓	✓	Horn/Strobe
	NS-24MCCH	✓	✓	Horn/Strobe
	ZNS-MCW	✓	✓	Horn/Strobe
	ZNS-MCWH	✓	✓	Horn/Strobe
	ZNS-24MCC	✓	✓	Horn/Strobe
	ZNS-24MCCH	✓	✓	Horn/Strobe

Table A-1: Compatible Notification Appliances

Manufacturer	Model	Audio	Visual	Type
Wheelock Con't	RSS-121575W		✓	Strobe
	RSS-241575W		✓	Strobe
	RSS-24MCC		✓	Strobe
	RSS-24MCCR		✓	Strobe
	RSS-24MCCH		✓	Strobe
	RSS-24MCCHR		✓	Strobe
	RSS-24MCW		✓	Strobe
	RSS-24MCWH		✓	Strobe
	RSSP-121575W		✓	Strobe
	RSSP-241575W		✓	Strobe
	RSSR-2415W		✓	Strobe
	RSSR-2415C		✓	Strobe
	RSSR-2475W		✓	Strobe
	RSSR-2475C		✓	Strobe
	RSSR-24110C		✓	Strobe
	RSSA-24110W		✓	Strobe
	RSSB-24110W		✓	Strobe
	RSSG-24110W		✓	Strobe
	RSSR-24110W		✓	Strobe
	RSSA-24MCC		✓	Multi-Cd Strobe
	RSSB-24MCC		✓	Multi-Cd Strobe
	RSSG-24MCC		✓	Multi-Cd Strobe
	RSSR-24MCC		✓	Multi-Cd Strobe
	RSSWPA-2475W		✓	Strobe Weatherproof
	RSSWPA-24MCCH		✓	Strobe Weatherproof
	RSSWPG-24MCCH		✓	Strobe Weatherproof
	RSSWPR-24MCCH		✓	Strobe Weatherproof
	RSSWP-2475W		✓	Strobe Weatherproof
	RSSWP-2475C		✓	Strobe Weatherproof

Table A-1: Compatible Notification Appliances

Manufacturer	Model	Audio	Visual	Type
Wheelock con't	RSSWP-24MCWH		✓	Strobe Weatherproof
	ZRS-MCWH		✓	Strobe
	ZRS-24MCC		✓	Strobe
	ZRS-24MCCH		✓	Strobe
	MB-G6-24			Motor Bell
	MB-G10-24			Motor Bell
	MB-G6-12			Motor Bell
	MB-G10-12			Motor Bell
	MIZ-24-R			Mini-Horn
	MT-12/24-R	✓	✓	Multitone Horn
	MT4-12/24	✓	✓	Multitone Horn
	ZRS-MCW		✓	Strobe
	MTWPR-24MCCH	✓	✓	Multitone Horn Strobe
	NH-12/24R	✓		Horn
	HSR		✓	Horn/Strobe
	HSW		✓	Horn/Strobe
	STR		✓	Strobe
	STW		✓	Strobe
	HNR		✓	Horn
	HNW		✓	Horn

A.2 Two-Wire Smoke Detectors

Table A-2 lists two-wire smoke detectors that are compatible with the fire control panel. The table is organized by manufacturer. The columns show the number of detectors per loop that can be used.

Table 1-1:

	5820XL
Identifier	24H
Operating Voltage Range	18.5–27.4 VDC

Note: The maximum number of smoke detectors per zone is determined by both the current draw and the impedance of the smoke detector. If too many smoke detectors are used on any zone, false alarms could occur.

Do not mix different models of detectors on any zone; false alarms could occur.

Do not mix detectors of different models unless the system is specifically intended to be installed in that configuration.

Control unit Smoke Reset Time must be programmed for a number greater than or equal to the maximum reset time of the smoke detector.

Table A-2: Compatible Two-Wire Smoke Detectors

Manufacturer	Model Name or Number (Base model name or number in parentheses.)	Compatibility ID		# per Loop
		Head	Base	
Apollo	55000-350 (45681-200)	55000-350	45681-200	24 / loop
	55000-250 (45681-200)	55000-250	45681-200	24 / loop
Apollo	55000-225	55000-225	45681-255, 256,	15 / loop for Ion Detectors
	55000-226	55000-226		
	55000-227	55000-227		
	55000-325	55000-325	45681-200, 220, 230, 232, 251,252	15 / loop for Photo Electric Detectors
	55000-328	55000-328		
	55000-326	55000-326		
	55000-327	55000-327		

Table A-2: Compatible Two-Wire Smoke Detectors

Manufacturer	Model Name or Number (Base model name or number in parentheses.)	Compatibility ID		# per Loop
		Head	Base	
ESL	429C (S10A)	N/A	S10A	30 / loop
	429CRT (S11A)	N/A	S11A	30 / loop
	429CST (S11A)	N/A	S11A	30 / loop
	429CT (S10A)	N/A	S10A	30 / loop
	609U01-11	S10	S00	40 / loop
	609U02-11	S10	S00/S03	40 / loop
	611U (601U or 602U)	S10	S00/S03	40 / loop
	611UD (601U or 602U)	S10	S00/S03	40 / loop
	611UT (601U or 602U)	S10	S00/S03	40 / loop
	612U (601U or 602U)	S10	S00/S03	40 / loop
	612UD (601U or 602U)	S10	S00/S03	40 / loop
	711U (701E or 701U)	N/A	S10A	25 / loop
	712U (701E or 701U)	N/A	S10A	25 / loop
	713-5U (702E or 701U)	N/A	S10A	25 / loop
	713-6U (702E or 701U)	N/A	S10A	25 / loop
	721-U (S10A)	N/A	S10A	30 / loop
	721-UT (S10A)	N/A	S10A	30 / loop
Falcon	525	FDT1	N/A	17 / loop
	525T	FDT1	N/A	17 / loop
Hochiki	SIH-24F (HS-224D OR HSD-224)	HD-3	HB-5	25 / loop
	SLK-24F (HS-224D)	HD-3	HB-5	25 / loop
	SLK-24FH (HS-224D)	HD-3	HB-5	25 / loop

Table A-2: Compatible Two-Wire Smoke Detectors

Manufacturer	Model Name or Number (Base model name or number in parentheses.)	Compatibility ID		# per Loop
		Head	Base	
System Sensor	1400	A	N/A	20 / loop
	1451 (B401B)	A	A	20 / loop
	2100	A	N/A	20 / loop
	2100T	A	N/A	20 / loop
	2151 (B401)	A	N/A	16 / loop
	2151T (B401)	A	N/A	16 / loop
	2300T	A	N/A	20 / loop
	2300	A	N/A	20 / loop
	2300TB	A	N/A	20 / loop
	2400	A	N/A	20 / loop
	2400 (DH400)	A	N/A	20 / loop
	2400AIT	A	N/A	20 / loop
	2400AT	A	N/A	20 / loop
	2400TH	A	N/A	20 / loop
	2451 (B401B)	A	N/A	20 / loop
	2451DH (DH 400)	A	N/A	20 / loop
	2451TH (B401B)	A	N/A	20 / loop
	2W-B	A	N/A	16 / loop
	2WT-B	A	N/A	16 / loop
	2WTR-B	A	N/A	16 / loop

Appendix B

Special Characters Lists

This section contains tables of programmable characters that may be used for device, module, and zone names or phone numbers.

B.1 Characters used for Naming

Table B-1 list the available character and their associated numeric designator. When programming these numbers can be entered as a short cut to using the up or down arrow keys, to select characters when naming a point or zone.

Table B-1: Character Table

000	A	001	B	002	C	003	D
004	E	005	F	006	G	007	H
008	I	009	J	010	K	011	L
012	M	013	N	014	O	015	P
016	Q	017	R	018	S	019	T
020	U	021	V	022	W	023	X
024	Y	025	Z	026	a	027	b
028	c	029	d	030	e	031	f
032	g	033	h	034	i	035	j
036	k	037	l	038	m	039	n
040	o	041	p	042	q	043	r
044	s	045	t	046	u	047	v
048	w	049	x	050	y	051	z
052		053	0	054	1	055	2
056	3	057	4	058	5	059	6
060	7	061	8	062	9	063	:
064	-	065	_	066	.	067	,
068	&	069	*	070	#		

Silent Knight Fire Product Warranty and Return Policy

General Terms and Conditions

- All new fire products manufactured by Silent Knight have a limited warranty period of 36 months from the date of manufacture against defects in materials and workmanship. See limited warranty statement for details.
- This limited warranty does not apply to those products that are damaged due to misuse, abuse, negligence, exposure to adverse environmental conditions, or have been modified in any manner whatsoever.

Repair and RA Procedure

- All products that are returned to Silent Knight for credit or repair require a RMA (Return Authorization) number. Call Silent Knight Customer Service at 800-328-0103 or 203-484-7161 between 8:00 A.M. and 5:00 P.M. EST, Monday through Friday to obtain a return authorization number.
- Silent Knight Technical Support is available at 800-446-6444 between 8:00 A.M. and 5:00 P.M. CST, Monday through Friday.
- All returns for credit are subject to inspection and testing at the factory before actual determination is made to allow credit.
- RMA number must be prominently displayed on the outside of the shipping box. See return address example under Advanced Replacement Policy.
- Include a packing slip that has the RMA number, a content list, and a detailed description of the problem should be included with each return.
- All products returned to Silent Knight must be sent freight pre-paid. After product is processed, Silent Knight will pay for shipping product back to customer via UPS ground.
- Return the Silent Knight product circuit board only. Products that are returned in cabinets will be charged an additional \$50 to cover the extra shipping and handling costs over board only returns. **Do not return batteries.** Silent Knight has the authority to determine if a product is repairable. Products that are deemed un-repairable will be returned to the customer.
- Product that is returned that has a board date code more than 36 months from date of manufacture will be repaired and the customer will be assessed the standard Silent Knight repair charge for that model.

Advanced Replacement Policy

- Silent Knight offers an option of advance replacement for fire product printed circuit boards that fail during the first 6 months of the warranty period. These items must be returned with transportation charges prepaid and must be accompanied by a return authorization.
- For advance replacement of a defective board contact your local Silent Knight Distributor or call Silent Knight at 203-484-7161 to obtain a RMA (Return Authorization) number and request advanced replacement,
- A new or refurbished board will be shipped to the customer. The customer will initially be billed for the replacement board but a credit will be issued after the repairable board is received at Silent Knight. All returned products must comply with the guidelines described under “General Terms and Conditions”.
- The defective board must be returned within 30 days of shipment of replacement board for customer to receive credit. No credit will be issued if the returned board was damaged due to misuse or abuse.
- Repairs and returns should be sent to:
Silent Knight / Honeywell
Attn: Repair Department
12 Clintonville Road
Northford, CT 06472
USA

RMA Number: _____

Limited Warranty

SILENT KNIGHT warrants products manufactured by it to be free from defects in materials and workmanship for thirty-six (36) months from the date of manufacture, under normal use and service. Products are date stamped at time of manufacture. The sole and exclusive obligation of SILENT KNIGHT is to repair or replace, at its option, free of charge for parts and labor, any part that is defective in materials or workmanship under normal use and service. **All returns for credit are subject to inspection and testing at the factory before actual determination is made to allow credit.** SILENT KNIGHT does not warrant products not manufactured by it, but assigns to the purchaser any warranty extended by the manufacturer of such products. This warranty is void if the product is altered or repaired by anyone other than SILENT KNIGHT or as expressly authorized by SILENT KNIGHT in writing, or is serviced by anyone other than SILENT KNIGHT or its authorized distributors. This warranty is also void if there is a failure to maintain the products and systems in which they operate in a proper and workable manner. In case of defect, secure a Return Material Authorization form from our Return Authorization Department.

This writing constitutes the only warranty made by SILENT KNIGHT, with respect to its products. SILENT KNIGHT, does not represent that its products will prevent any loss by fire or otherwise, or that its products will in all cases provide the protection for which they are installed or intended. Buyer acknowledges that SILENT KNIGHT is not an insurer and assumes no risk for loss or damages or the cost of any inconvenience, transportation damage, misuse, abuse, accident or similar incident.

SILENT KNIGHT GIVES NO WARRANTY, EXPRESS OR IMPLIED, OF MERCHANTABILITY, FITNESS FOR ANY PARTICULAR PURPOSE, OR OTHERWISE WHICH EXTENDS BEYOND THE DESCRIPTION ON THE FACE HEREOF. UNDER NO CIRCUMSTANCES SHALL SILENT KNIGHT BE LIABLE FOR ANY LOSS OF OR DAMAGE TO PROPERTY, DIRECT, INCIDENTAL OR CONSEQUENTIAL, ARISING OUT OF THE USE OF, OR INABILITY TO USE SILENT KNIGHT ALARM'S PRODUCTS. FURTHERMORE, SILENT KNIGHT SHALL NOT BE LIABLE FOR ANY PERSONAL INJURY OR DEATH WHICH MAY ARISE IN THE COURSE OF, OR AS A RESULT OF, PERSONAL, COMMERCIAL OR INDUSTRIAL USE OF ITS PRODUCTS

This warranty replaces all previous warranties and is the only warranty made by SILENT KNIGHT. No increase or alteration, written or verbal, of the obligation of this warranty is authorized.

“SILENT KNIGHT” is a registered trademark.



**SILENT
KNIGHT**

by Honeywell

12 Clintonville Road
Northford, CT 06472-1610 USA
203-484-7161
Fax 203-484-7118
www.silentknight.com

© 2009 Honeywell International Inc.

Free Manuals Download Website

<http://myh66.com>

<http://usermanuals.us>

<http://www.somanuals.com>

<http://www.4manuals.cc>

<http://www.manual-lib.com>

<http://www.404manual.com>

<http://www.luxmanual.com>

<http://aubethermostatmanual.com>

Golf course search by state

<http://golfingnear.com>

Email search by domain

<http://emailbydomain.com>

Auto manuals search

<http://auto.somanuals.com>

TV manuals search

<http://tv.somanuals.com>