

# **MS5100**

---

Eclipse™ Series

## **Installation and User's Guide**

## **Disclaimer**

Honeywell International Inc. ("HII") reserves the right to make changes in specifications and other information contained in this document without prior notice, and the reader should in all cases consult HII to determine whether any such changes have been made. The information in this publication does not represent a commitment on the part of HII.

HII shall not be liable for technical or editorial errors or omissions contained herein: nor for incidental or consequential damages resulting from the furnishing, performance, or use of this manual.

This document contains propriety information that is protected by copyright. All rights reserved. No part of this document may be photocopied, reproduced, or translated into another language without the prior written consent of HII.

© 2009 Honeywell International Inc. All rights reserved.

Web Address: [www.honeywell.com/aidc](http://www.honeywell.com/aidc)

## **Trademarks**

Metrologic, MetroSelect, MetroSet2, CodeGate, and CodeSense are trademarks or registered trademarks of Metrologic Instruments, Inc. or Honeywell International Inc.

Microsoft, Windows, and Windows 95 are trademarks or registered trademarks of Microsoft Corporation.

IBM is a trademark of International Business Machines Corporation.

Other product names mentioned in this manual may be trademarks or registered trademarks of their respective companies and are the property of their respective owners.

## **Patents**

Please refer to page 41 for a list of patents.

# TABLE OF CONTENTS

---

Introduction.....	1
Scanner and Accessories.....	2
Scanner Components.....	4
Maintenance.....	4
Caution and Serial Number Labels.....	5
Cable Removal.....	6
Cable Connection Warning.....	6
Installation	
RS232, Light Pen or Laser Emulation.....	7
RS485.....	8
Keyboard Wedge.....	9
Stand-Alone Keyboard.....	10
Low Speed USB (-38).....	11
Full Speed (-40).....	11
Scanner Operation	
How to Use CodeGate® and the Manual Activation Mode.....	12
Two Modes of Operation.....	12
Indicators.....	13
Audible.....	13
Visual.....	14
Failure.....	15
Depth of Field.....	16
Configuration Modes.....	17
Troubleshooting Guide.....	20
RS232 Demonstration Program.....	23
Design Specifications.....	24
Applications and Protocols.....	26
Default Settings.....	27
Upgrading the Firmware.....	32
Scanner and Cable Terminations	
Scanner Pinout Connections.....	33
Cable Connector Configurations.....	35

# TABLE OF CONTENTS

---

Regulatory Compliance	
Safety .....	37
EMC .....	38
Limited Warranty .....	40
Patents .....	41
Index .....	42
Contact Information .....	44
Product Service and Repair.....	45

# INTRODUCTION

---

The MS5145 Eclipse™ is a single-line, hand-held laser scanner.

Equipped with Honeywell's patented CodeGate® technology, Eclipse can be used in a wide variety of applications. CodeGate technology allows the user to easily target the desired bar code and complete the data transmission with a simple press of a button. This combination makes Eclipse a perfect selection for menu scanning, point-of-sale, document processing and inventory control.

With state-of-the-art scanning technology embedded inside, the MS5145 Eclipse has a longer working range and a wider scan field than a typical CCD. The width of the scan line grows as the scanner moves further away from bar codes. In addition, the laser beam pulses, making lining up bar codes easy and when the scanner senses a bar code (CodeSense® Mode), the laser beam automatically switches to scan mode and activates CodeGate to ensure high-speed scanning and accuracy.

Many standard features are included such as: user configurable Flash ROM, PowerLink user-replaceable cables, MetroSet® 2 and MetroSelect® configuration, and data editing (parsing).

ECLIPSE MODEL NUMBER	INTERFACE
MS5145 – 00	Laser Emulation
MS5145 – 11	RS485▲, RS232-TXD, RXD, RTS, CTS
MS5145 – 14	RS232 - TXD, RXD, RTS, CTS, DTR, DSR
MS5145 – 38	RS232 Low Speed USB, Keyboard Emulation or Serial Emulation*
MS5145 – 40	Full Speed USB
MS5145 – 41	RS232/Light Pen Emulation
MS5145 – 47	Keyboard Wedge, Stand Alone Keyboard and RS232 Transmit/Receive

\* Configurable for Keyboard Emulation Mode or Serial Emulation Mode. The default setting is Keyboard Emulation Mode.

▲ Applicable for IBM® Host applications.

## Scanner and Accessories

<b>BASIC KIT</b>	
<b>Part #</b>	<b>Description</b>
MS5145	Eclipse Scanner
00-02544	MetroSelect Single-Line Configuration Guide*
70-79016	MS5100 Eclipse Series Installation and User's Guide*

\*Available for download from [www.honeywell.com/aidc](http://www.honeywell.com/aidc)

<b>OPTIONAL ACCESSORIES</b>	
<b>Part #</b>	<b>Description</b>
AC to DC Power Transformer- Regulated 5.2VDC @ 1A output.	
46-00525	90VAC to 255VAC, United States, Canada and Japan
46-00526	90VAC to 255VAC, Continental European
46-00527	90VAC to 255VAC, United Kingdom
46-00528	90VAC to 255VAC, Australia
46-00529	90VAC to 255VAC, China
46-00530	90VAC to 255VAC, India

*Other items may be ordered for the specific protocol being used. To order additional items, contact the dealer, distributor or call Customer Service Department, see page 44.*

Scanner and Accessories

OPTIONAL ACCESSORIES	
Part #	Description
55-55000.x-3	RS232 PowerLink Cable with Built in Power Jack straight cord, long strain relief, black
55-55002.x-3	Keyboard Wedge PowerLink Cable with Adapter straight cord, long strain relief, black
55-55020.x-3	Stand Alone Keyboard PowerLink Cable, straight cord, long strain relief, black
55-55235.x-N-3	USB Low Speed Communication Cable, Type A straight cord, long strain relief, black
55-55200.x-N-3	USB Full Speed Cable, Locking Plus-Power™ Type A straight cord, long strain relief, black  This cable is for use with full speed USB (-40) interface only.
MVC**	RS485 <sup>▲</sup> Applications, Metrologic Voltage Converter Cable, ±12VDC to +5.2VDC
** <i>Contact a customer service representative for additional information on the MVC converter cable series and the host connections available.</i>	
46-46633	Countertop Stand

Other items may be ordered for the specific protocol being used. To order additional items, contact the dealer, distributor or call Customer Service Department, see page 44.

<sup>▲</sup> Applicable for IBM® Host applications.

**Scanner Components**

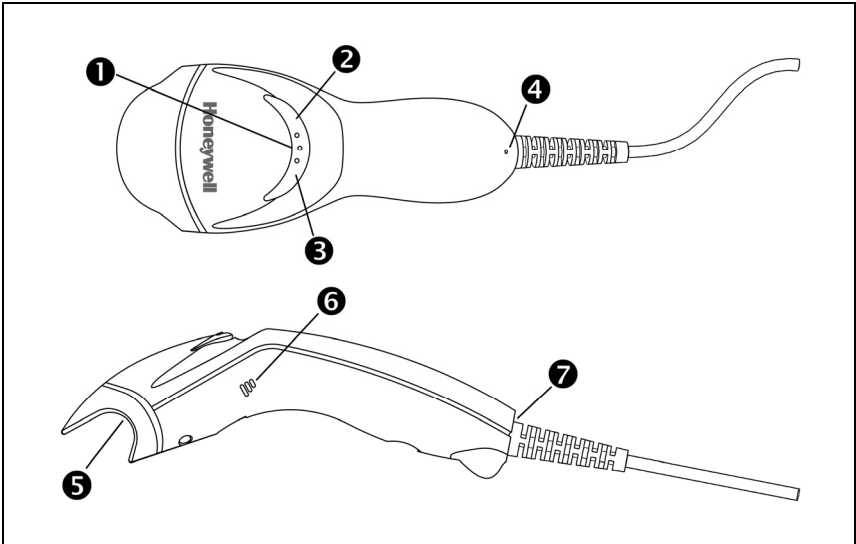

ITEM NO.	DESCRIPTION
1	Mode Select Button/CodeGate Button (see page 12)
2	Red LED (see page 14)
3	Green LED (see page 14)
4	Pin Hole for Cable Release (see page 6)
5	Red Output Window (Laser Aperture)
6	Speaker (see page 13)
7	10-Pin RJ45, Female Socket (see page 33)

Figure 1. Scanner Components

**Maintenance**

Smudges and dirt on the unit’s window can interfere with the unit’s performance. If the window requires cleaning, use only a mild glass cleaner containing no ammonia. When cleaning the window, spray the cleaner onto a lint free, non-abrasive cleaning cloth then gently wipe the window clean.

If the unit’s case requires cleaning, use a mild cleaning agent that does not contain strong oxidizing chemicals. Strong cleaning agents may discolor or damage the unit’s exterior.



Caution and Serial Number Labels

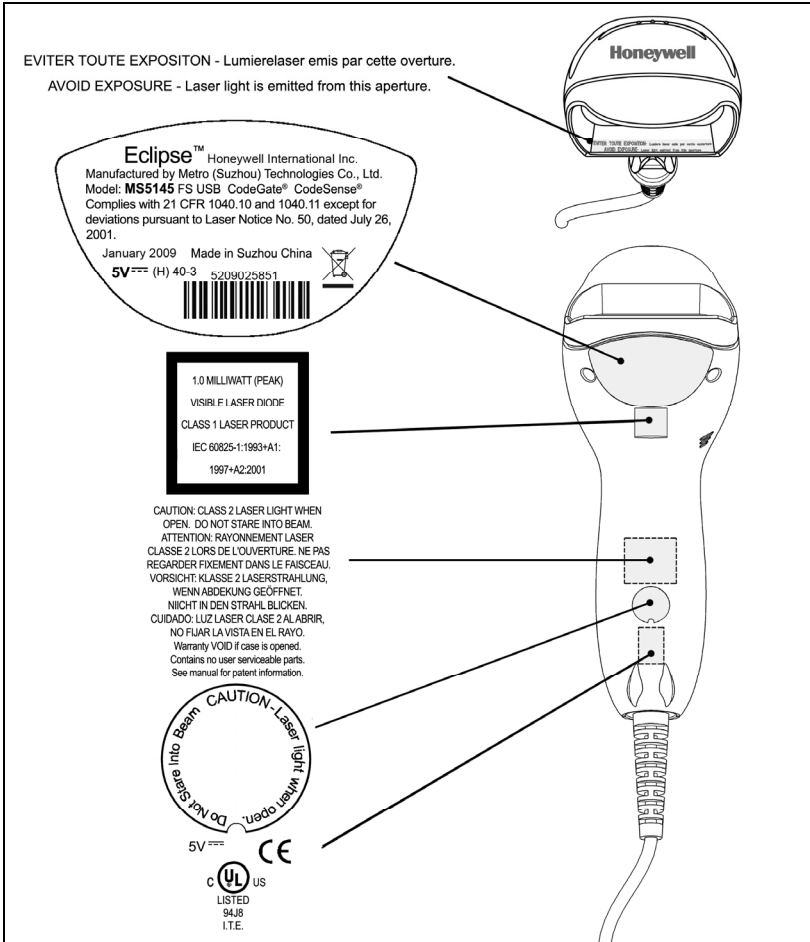

Figure 2. Label Location on the Bottom of the Scanner with Example

**Caution**

To maintain compliance with applicable standards, all circuits connected to the scanner must meet the requirements for SELV (Safety Extra Low Voltage) according to EN/IEC 60950-1.



To maintain compliance with standard CSA C22.2 No. 60950-1/UL 60950-1 and norm EN/IEC 60950-1, the power source should meet applicable performance requirements for a limited power source.

## Cable Removal

Disconnect the power supply from the PowerLink cable and turn off power to the host system before removing the cable from the scanner.

1. Locate the small 'pin-hole' on the front side of the scanner near the end of the handle.
2. Bend an ordinary paperclip into the shape shown.
3. Insert the paperclip (or other small metallic pin) into the small 'pin-hole'. There will be a faint 'click' when the connector's lock releases.
4. Pull gently on the cable's strain-relief to remove the cable.

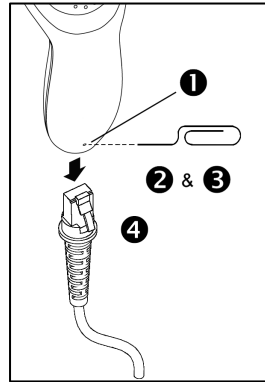

Figure 3.

## Cable Connection Warning

**i** Important: If the PowerLink cable is not fully latched, the unit can power intermittently.

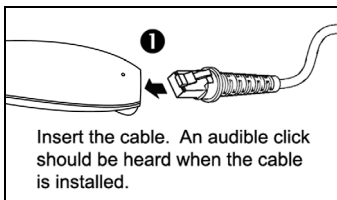

Figure 4.

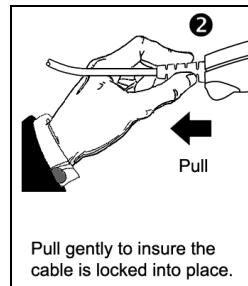

Figure 5.

### RS232, Light Pen or Laser Emulation

1. Turn off the host system.
2. Plug the male, 10-pin RJ45 end of the PowerLink cable into the 10-pin socket on the MS5145.
3. Connect the 9-pin female end of the PowerLink cable to the appropriate communication port on the host device.
4. Plug the external power supply into the power jack on the PowerLink cable.



Check the AC input requirements of the power supply to make sure the voltage matches the AC outlet. The outlet must be located near the equipment.

5. Connect AC power to the transformer.
6. Turn on the host system.

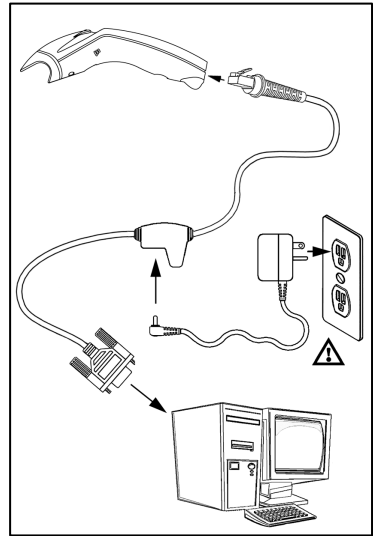

Figure 6. RS232, Light Pen, or Laser Emulation Connections



Plugging the scanner into the serial port of the PC does not guarantee that scanned information will appear at the PC. A software driver and correct configuration settings are also required for proper communications to occur.



Powering the MS5145 directly from the host device can sometimes cause interference with the operation of the scanner or the computer. Not all computers supply the same current. For this reason, using an external power supply is recommended. For additional information, contact a customer service representative.



All MS5145-00 scanners leave the factory with the Laser Emulation Mode enabled. If recall defaults is scanned while re-configuring the scanner the Laser Emulation Mode will no longer be enabled. Refer to the MS5145-00 Laser Emulation Mode section of the MetroSelect Single-Line Configuration Guide for information on enabling the Laser Emulation Mode.



See page 5.

## INSTALLATION

---

### RS485<sup>▲</sup>

1. Turn off the host system.
2. Plug the male 10-pin RJ45 end of the MVC cable into the 10-pin socket on the MS5145.
3. Connect the other end of the MVC cable to Port 9 of the host device.
4. Turn on the host device

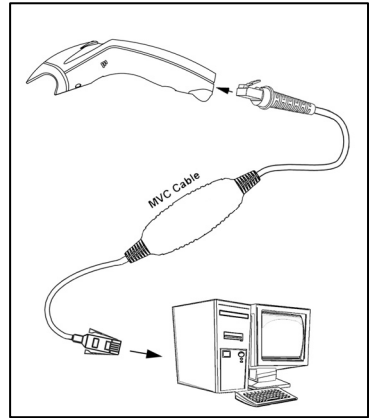

Figure 7. RS485<sup>▲</sup> (above)  
Connections



See page 5.

<sup>▲</sup> Applicable for IBM<sup>®</sup> Host applications.

## INSTALLATION

### Keyboard Wedge

1. Turn off the host system.
2. Plug the male, 10-pin RJ45 end of the PowerLink cable into the 10-pin socket on the MS5145.
3. Disconnect the keyboard from the host/PC.
4. Connect the Y ends of the PowerLink cable to the keyboard and the host's keyboard port. If necessary, use the supplied adapter cable to make the connections.
5. Plug the external power supply into the power jack on the PowerLink cable.



Check the AC input requirements of the power supply to make sure the voltage matches the AC outlet. The outlet must be located near the equipment.

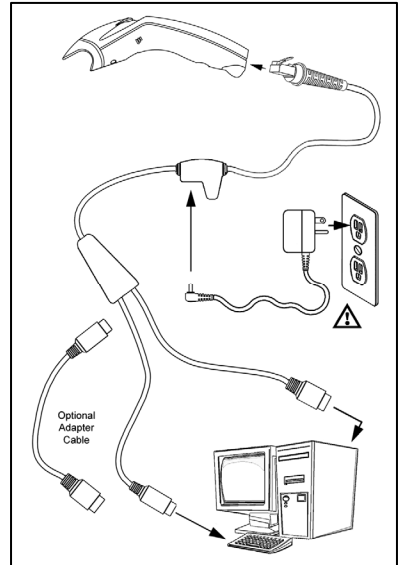

Figure 8. Keyboard Wedge Connections

6. Connect AC power to the transformer.
7. Turn on the host system.



Powering the MS5145-47 directly from the computer can sometimes cause interference with the operation of the scanner or the computer. Not all computers supply the same current through the keyboard port, explaining why a scanner may work on one computer and not another. Contact a customer service representative if an external power supply is required.



See page 5.

## INSTALLATION

### Stand-Alone Keyboard

1. Turn off the host system.
2. Connect the 10-pin RJ45 male connector into the jack on the Eclipse. There will be a 'click' when the connection is made.



If the scanner is receiving power from the host system, skip to step #5.

3. Connect the L-shaped plug of the power supply into the power jack on the PowerLink cable.



Make sure the AC input requirements of the power supply match the AC outlet. Connect the power supply into an AC outlet. The outlet should be near the equipment and easily accessible.

4. Connect the PowerLink cable to the keyboard port on the host system.
5. Turn on the host system.

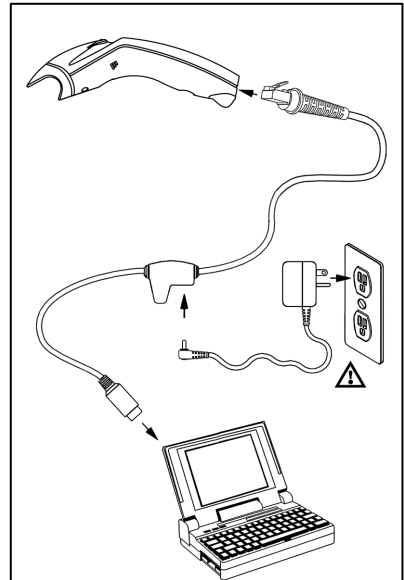

Figure 9. Stand-Alone Keyboard Connection



Powering the MS5145-47 directly from the computer can sometimes cause interference with the operation of the scanner or the computer. Not all computers supply the same current through the keyboard port, explaining why a scanner may work on one computer and not another. Contact a customer service representative if an external power supply is required.



See page 5.

### USB: Low Speed USB (-38) Full Speed USB (-40)

1. Turn off the host system.
2. Connect the 10-pin RJ45 male connector of the USB cable into the jack on the Eclipse. There will be a 'click' when the connection is made.
3. Connect the other end of the USB cable to the host USB port.
4. Turn on the host system.

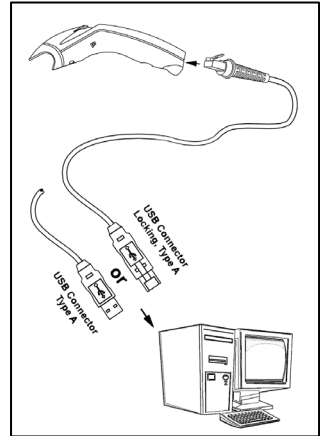

Figure 10. USB



As a default, the MS5145-38 leaves the factory with *USB Keyboard Emulation Mode* enabled.

For information on configuring the MS5145-38 for *USB Serial Emulation Mode*, please refer to the *USB* section of the MetroSelect Single-Line Configuration Guide (00-02544X).



Plugging the scanner into a port on the host system does not guarantee that scanned information will be communicated properly to the host system. All Eclipse's are shipped already configured with a set of factory defaults. Please refer to the MetroSelect Single-Line Configuration Guide or MetroSet2's help files for instructions on changing the scanner's factory default configuration. The scanner and host system must use the same communication protocols.



See page 5.

## How to Use CodeGate and the Manual Activation Mode

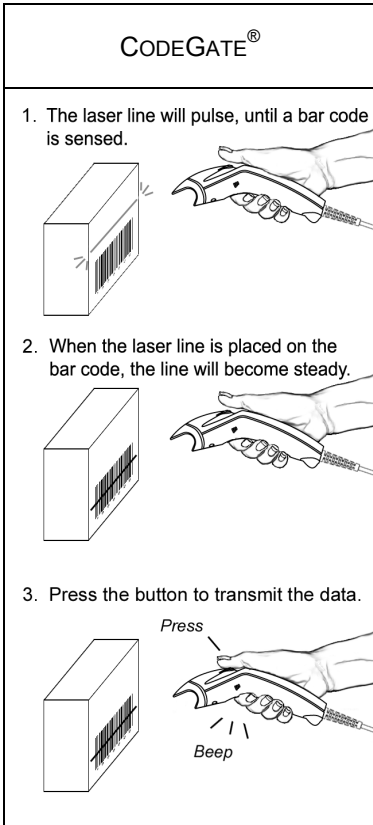

Figure 11. CodeGate Enabled

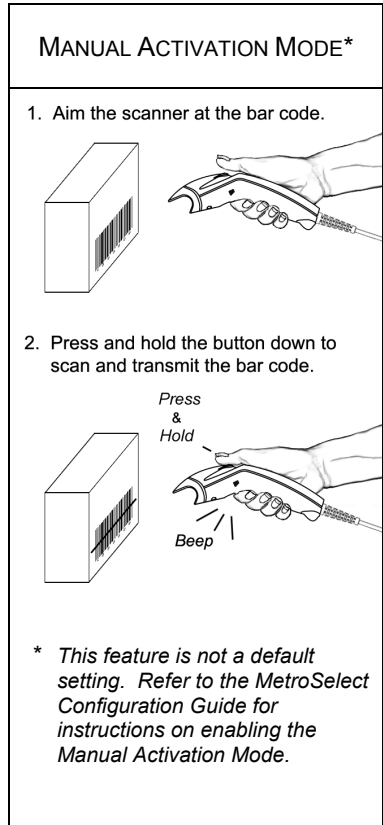

Figure 12. Manual Activation Mode

## Two Modes of Operation

### CodeGate, Out-of-Stand

- CodeGate activates when removed from the stand
- Bar code data is transmitted when the button is pressed

### Manual Activation Mode\*, Out-of-Stand

- Button activates laser
- Bar code data is scanned and transmitted while button is held down



## Indicators

### Audible

When the MS5145 scanner is operational, the scanner provides audible feedback to indicate the status of the scanner and the last scan. Eight settings are available for the tone of the beep (normal, six alternate tones and no tone). For instructions on how to change the tone of the beeper, refer to the Single-Line MetroSelect Configuration Guide.



#### One Beep – On Power Up

The green LED will turn on, then the red LED will flash and the scanner will beep once. The red LED will remain on for the duration of the beep. The scanner is now ready to scan.



#### One Beep – During Operation

When the scanner successfully reads a bar code, the red LED will flash and the scanner will beep once (if programmed to do so). If the scanner does not beep once and the red light does not flash, then the bar code has not been successfully read.



#### Three Beeps – During Operation

When entering the configuration mode, the red LED will flash while the scanner simultaneously beeps three times. The red LED will continue to flash until the unit exits configuration mode. Upon exiting configuration mode, the scanner will beep three times and the red LED will stop flashing.

When configured for communication timeout, three beeps during operation will indicate that a communication timeout has occurred.



#### Three Beeps – On Power Up

This is a failure indicator. Refer to the *Failure Modes* section of this guide on page 15.



#### Razzberry Tone

This is a failure indicator or an invalid code read during configuration mode. Refer to the *Failure Modes* section of this guide on page 15.

### Indicators

#### Visual

The MS5145 is equipped with a red LED and green LED which indicate the scanner's state and the status of the current scan when the unit is in operation.

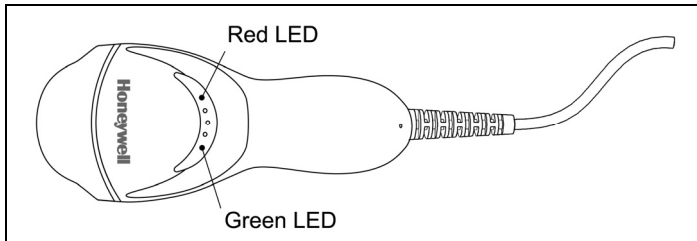

Figure 13. LED Color and Location

#### **Green and Red LEDs Are Off**

The LEDs will not be illuminated if the scanner is not receiving power from the host or transformer.

#### **Steady Green**

Indicates normal pulse or continuous laser operation. Accompanied by a razzberry tone, it indicates that an invalid bar code has been scanned.

#### **Flashing Green**

After a period of inactivity, the *ON* time of the pulsing laser will be shortened. During this time the green LED will flash. This indicates that the scanner is in a *power saver* mode. When a bar code enters the laser field, the scanner will wake up and return to normal pulse mode.

#### **Steady Green and Single Red Flash**

When the scanner successfully reads a bar code, the red LED will flash and the scanner will beep. If the red LED does not flash and the scanner does not beep, then the bar code has not been successfully read.

#### **Steady Green and Steady Red**

After a successful read, the scanner transmits the data to the host device. Some communication modes require that the host inform the scanner when data is ready to be received. If the host is not ready to accept the information, the scanner's red LED will remain on until the data can be transmitted.

#### **Steady Green and Continuous Flashing Red**

When entering the configuration mode, the red LED will flash, the green LED will turn on and the scanner will beep three times. The red LED will continue to flash and the green LED will stay on until the unit exits the configuration mode.

### Indicators

#### Failure



##### **One Razzberry Tone – On Power Up**

This indicates the scanner has experienced a laser or flipper subsystem failure. Return the unit for repair to an Authorized Service Center.

##### **Continuous Razzberry Tone with no LEDs**

If, upon power up, the scanner emits a continuous razzberry tone, then the scanner has an experienced an electronic failure. Return the unit for repair to an Authorized Service Center.

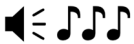

##### **Three Beeps – On Power Up**

If the scanner beeps three times on power up, then the non-volatile memory (NovRAM) that holds the scanner configuration has failed. Return the unit for repair to an Authorized Service Center.

Depth of Field vs. Minimum Bar Code Element Width

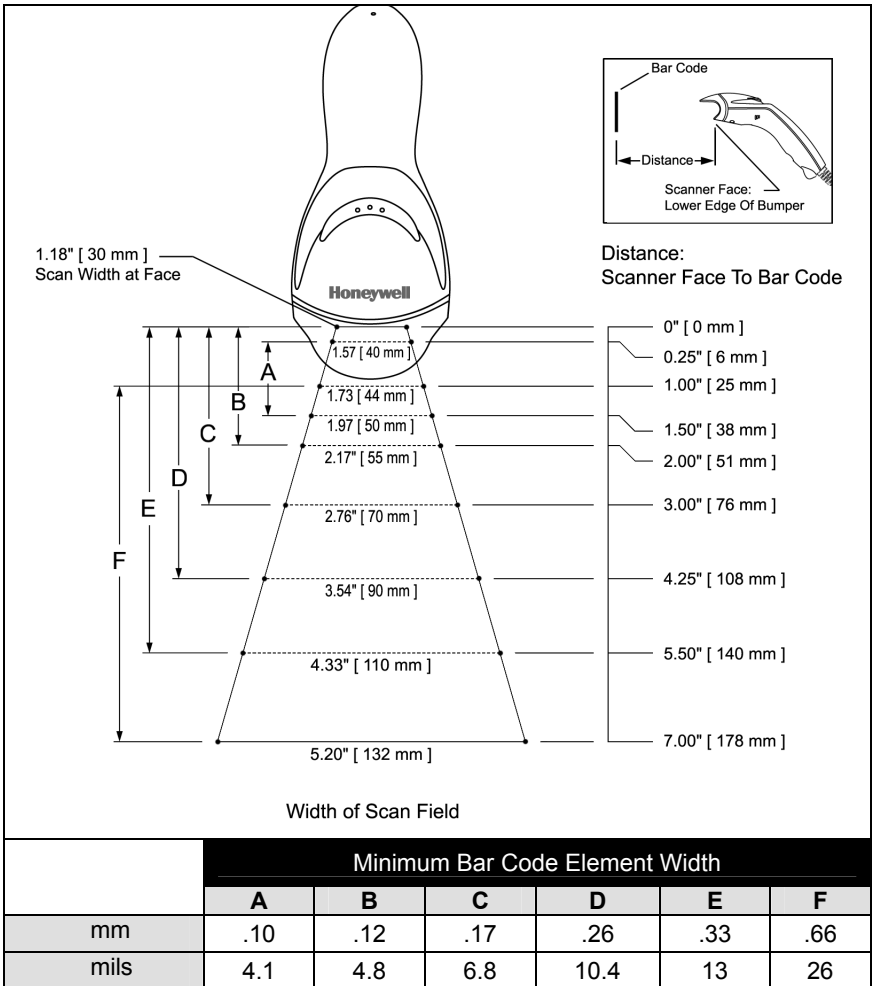

Figure 14. Depth of Field vs. Minimum Bar Code Element Width

### Configuration Modes

The MS5145 Eclipse has three modes of configuration.

- **Bar Codes**

The Eclipse can be configured by scanning the bar codes located in the MetroSelect® Single-Line Configuration Guide (MLPN 00-02544). This manual can be downloaded FREE at [www.honeywell.com/aidc](http://www.honeywell.com/aidc).

- **MetroSet® 2**

This user-friendly Windows-based configuration software allows the user to simply 'point-and-click' at the desired scanner options. This software can be downloaded FREE at [www.honeywell.com/aidc](http://www.honeywell.com/aidc) or set-up disks can be ordered by calling a customer service representative, see page 44.

- **Serial Configuration**

This mode of configuration is ideal for OEM applications. This mode gives the end-user the ability to send a series of commands using the serial port of the host system. The commands are equivalent to the numerical values of the bar codes located in the MetroSelect Single-Line Configuration Guide (MLPN 00-02544).

*How does Serial Configuration work?*

1. Each command sent to the scanner is the ASCII representation of each numeral in the configuration bar code. The entire numeric string is framed with an ASCII [stx] and an ASCII [etx].

**EXAMPLE #1:**

Command for Disabling Codabar

Command = [stx]100104[etx]

String Sent to Scanner = 02h 31h 30h 30h 31h 30h 34h 03h

(All values are hexadecimal).

2. If the command sent to the scanner is valid, the scanner will respond with an [ack].
3. If the command sent to the scanner is invalid, the scanner will respond with a [nak].

**Note:** If this occurs, the end-user must start over at the very beginning of the configuration sequence. Re-transmitting the invalid command will not work. The user must start over.

## SCANNER OPERATION

---

4. During configuration, the motor and laser turn off. YOU CANNOT SCAN A BAR CODE WHILE IN SERIAL CONFIGURATION MODE.
5. There is a 20 second window between commands. If a 20 second timeout occurs, the scanner will send a [nak] and you must start over.
6. To enter serial configuration mode, send the following command [stx]999999[etx].
7. To exit serial configuration mode, send the following command [stx]999999[etx], the scanner will respond with an [ack] followed by 3 beeps.
8. This mode uses the current Baud Rate, Parity, Stop Bits and Data Bits settings that are configured in the scanner. The default settings of the scanner are 9600, Space, 2, 7 respectively. If a command is sent to the scanner to change any of these settings, the change will NOT take effect until after serial configuration mode is exited.

### EXAMPLE #2:

The following example will set the scanner to the factory default settings, Disable Scanning of Code 128 bar codes, change the beeper tone, and add a "G" as a configurable prefix.

<b>FEATURE</b>	<b>HOST COMMAND</b>	<b>ASCII REPRESENTATION</b>	<b>SCANNER RESPONSE</b>
Enter Configuration Mode	[stx]999999[etx]	02h 39h 39h 39h 39h 39h 39h 03h	[ack] or 06h
Load Defaults	[stx]999998[etx]	02h 39h 39h 39h 39h 39h 38h 03h	[ack] or 06h
Disable Code 128	[stx]100113[etx]	02h 31h 30h 30h 31h 31h 33h 03h	[ack] or 06h
Alternate Tone 1	[stx]318565[etx]	02h 33h 31h 38h 35h 36h 35h 03h	[ack] or 06h
Configure. Prefix #1	[stx]903500[etx]	02h 39h 30h 33h 35h 30h 30h 03h	[ack] or 06h
Code Byte 0	[stx]0[etx]	02h 30h 03h	[ack] or 06h
Code Byte 7	[stx]7[etx]	02h 37h 03h	[ack] or 06h
Code Byte 1	[stx]1[etx]	02h 31h 03h	[ack] or 06h
Exit Configuration Mode	[stx]999999[etx]	02h 39h 39h 39h 39h 39h 39h 03h	[ack] or 06h

The scanner will beep three times!

The commands sent to the scanner do not include the small superscripted three (<sup>3</sup>) that you see in front of each bar code string in the MetroSelect manual. THE THREE (<sup>3</sup>) SHOULD NOT BE SENT. IT IS A CODE TYPE DESIGNATION ONLY!

For commands requiring additional bar codes to be scanned (such as prefixes, suffixes, timeouts, etc.), simply send the code bytes in the same order that you would normally scan the bar codes.

## SCANNER OPERATION

---

### EXAMPLE #3:

The following example shows the events that occur when an invalid bar code is sent. This sample will load the factory default settings and then set the baud rate to 19200.

<u>FEATURE</u>	<u>HOST COMMAND</u>	<u>ASCII REPRESENTATION</u>	<u>SCANNER RESPONSE</u>
Enter Configuration Mode	[stx]999999[etx]	02h 39h 39h 39h 39h 39h 39h 03h	[ack] or 06h
Load Defaults	[stx]999999:[etx]	02h 39h 39h 39h 39h 39h 3Ah 03h	[nak] or 15h
Invalid command was sent, you must start over!			
Enter Configuration Mode	[stx]999999[etx]	02h 39h 39h 39h 39h 39h 39h 03h	[ack] or 06h
Load Defaults	[stx]999998[etx]	02h 39h 39h 39h 39h 39h 39h 03h	[ack] or 06h
19200 Baud Rate	[stx]415870[etx]	02h 34h 31h 35h 38h 37h 30h 03h	[ack] or 06h
Exit Configuration Mode	[stx]999999[etx]	02h 39h 39h 39h 39h 39h 39h 03h	[ack] or 06h

The scanner will beep three times!

This example illustrates two important points.

First, if an invalid command is sent from the host, the scanner responds with a [nak] and the end-user must start over from the beginning.

Second, if a command is sent to change the Baud Rate, the new baud rate does not take effect until after the end-user exits configuration mode.

### ABBREVIATED ASCII TABLE

<b>Character</b>	<b>Hex Value</b>	<b>Decimal Value</b>
[STX]	02h	2
[ETX]	03h	3
[ACK]	06h	6
[NAK]	15h	21
0	30h	48
1	31h	49
2	32h	50
3	33h	51
4	34h	52
5	35h	53
6	36h	54
7	37h	55
8	38h	56
9	39h	57

## TROUBLESHOOTING GUIDE

The following guide is for reference purposes only. Contact a customer service representative (see page 44) to preserve the limited warranty terms.

Symptoms	Possible Causes	Solution
<i>All Interfaces</i>		
The unit has no LEDs, beep or laser.	No power is being supplied to the unit.	Check the transformer, the outlet and power strip. Make sure the cable is plugged into the unit.
	No power is being supplied to the unit from host.	Some host systems cannot supply enough current to power Eclipse. A power supply may be needed.
At power up the unit beeps two times and alternately flashes the LEDs.	There is a ROM failure.	A flash ROM upgrade is required.
At power up the unit beeps three times.	There is a non-volatile RAM failure.	Contact a customer service representative.
At power up there is a continuous razz tone.	There has been a diagnostic failure.	
At power up there is a razz tone and the green LED flashes.	There is a VLD failure.	
At power up there is a razz tone and both LEDs flash.	There is a scanning mechanism failure.	
The unit scans, communicates and beeps twice.	The same symbol timeout is set too short.	Adjust the same symbol timeout for a longer time.
The unit powers up, but does not beep.	The beeper may be disabled or no tone has been selected.	Enable beeper and select a tone.



## TROUBLESHOOTING GUIDE

Symptoms	Possible Causes	Solution
The unit powers up, but does not scan and/or beep.	The unit is trying to scan a particular symbology that is not enabled.	UPC/EAN, Code 39, interleaved 2 of 5, Code 93, Code 128 and Codabar are enabled by default. Verify the type of bar code being read has been selected.
The unit powers up, but does not scan and/or beep.	The bar code being scanned does not satisfy the configured criteria for character length lock or minimum length.	Verify the bar code being scanned falls into the configured criteria.  <i>The scanner defaults to a minimum of three-character bar code.</i>
<b>RS232 &amp; Serial Emulation USB Interfaces</b>		
The unit scans a bar code, but locks up after the first scan and the red LED stays on.	The unit is configured to support some form of host handshaking but is not receiving the signal.	If the unit is setup to support ACK/NAK, RTS/CTS, XON/XOFF or D/E, verify that the host cable and host are supporting the handshaking properly.
The unit scans, but the data transmitted to the host is incorrect.	The unit's data format does not match the host system's requirements.	Verify the unit's data format matches that required by the host. Make sure that the unit is connected to the proper host port.
The unit beeps at some bar codes but NOT for others of the same bar code symbology.	The bar code may have been printed incorrectly.	Check if it is a check digit/character/or border problem.
	The unit is not configured correctly for the type of bar code being scanned.	
	The minimum symbol length setting does not work with the bar code.	Check if the correct minimum symbol length is set.
<b>Keyboard Wedge Interface</b>		
The unit scans the bar code but there is no data.	The unit's configuration is not correct.	Make sure the scanner is configured for the appropriate mode.

## TROUBLESHOOTING GUIDE

Symptoms	Possible Causes	Solution
The unit scans but the data is not correct.	The unit's configuration is not correct.	Make sure that the proper PC type AT, PS2 or XT is selected. Verify the correct country code and data format is selected. Adjust the inter-character delay symptom.
The unit is transmitting each character twice.	The unit's configuration is not correct.	Increase the interscan code delay setting. Adjust whether the F0 break is transmitted. It may be necessary to try this in both settings.
Alpha characters show as lower case.	The computer is in <i>Caps Lock</i> mode.	Enable the <i>Caps Lock</i> detect feature of the scanner to detect whether the PC is operating in Caps Lock.
Everything works except for a couple of characters.	These characters may not be supported by that country's key look up table.	Try operating the scanner in Alt mode.
<b>RS232 Interface</b>		
The unit powers-up OK and scans OK but does not communicate properly to the host.	The com port at the host is not working or not configured properly.	Check to make sure the baud rate and parity of the scanner and the port match and that the configuration is looking for "RS232" data.
	The cable is not connected to the proper com port.	Check to make sure the unit is connected to the correct com port on the host device.
The host is receiving data but the data does not look correct.	The scanner and host may not be configured for the same interface parameters.	Check the scanner and the host are configured for the same interface parameters.
Characters are being dropped.	Inter-character delay needs to be added to the transmitted output.	Add some inter-character delay to the transmitted output by using the MetroSelect Single-Line Configuration Guide.

## RS232 DEMONSTRATION PROGRAM

---

If an RS232 scanner is not communicating with your IBM compatible PC, key in the following BASIC program to test that the communication port and scanner are working.

This program is for demonstration purposes only. It is only intended to prove that cabling is correct, the COM port is working, and the scanner is working. If the bar code data displays on the screen while using this program, it only demonstrates that the hardware interface and scanner are working. At this point, investigate whether the application software and the scanner configuration match.

If the application does not support RS232 scanners, a software wedge program that will take RS232 data and place it into a keyboard buffer may be needed. This program tells the PC to ignore RTS-CTS, Data Set Ready (DSR) and Data Carrier Detect (DCD) signals. If the demonstration program works and yours still does not, jumper RTS to CTS and Data Terminal Reading (DTR) to DCD and DSR on the back of your PC.

```
10      CLS
20      ON ERROR GOTO 100
30      OPEN "COM1:9600,S,7,1,CSO,DSO,CD0,LF" AS#1
35      PRINT "SCAN A FEW BAR CODES"
40      LINE INPUT #1, BARCODE$
50      PRINT BARCODE$
60      K$ = INKEY$: IF K$ = CHR$(27) THEN GOTO 32766
70      GOTO 40
100     PRINT "ERROR NO. "; ERR ; "PRESS ANY KEY TO TERMINATE."
110     KK$ = INKEY$: IF K$ = "" THEN GOTO 110
32766   CLOSE: SYSTEM
32767   END
```

## DESIGN SPECIFICATIONS

		<b>MS5145 Eclipse</b>	
<b>OPERATIONAL</b>			
Light Source:	Visible Laser Diode (VLD) @ 650 nm		
Laser Power:	Less than 1.0 mW average		
Depth of Scan Field:	0 mm – 140 mm (0" – 5.5")	0.33 mm (13 mil) Bar Code	
Scan Speed:	72 ± 2 scan lines per second		
Scan Pattern:	Single scan line		
Minimum Bar Width:	0.089 mm (3.5 mil)		
Decode Capability:	Autodiscriminates all standard bar codes. For other code types, call a customer service representative.		
System Interfaces:	RS232, Keyboard Wedge, USB, Light Pen Emulation, RS485 <sup>▲</sup> , Stand Alone Keyboard		
Print Contrast:	35% minimum reflectance difference		
No. Characters Read:	Up to 80 data characters. The maximum number will vary based on symbology and density.		
Roll, Pitch, Yaw:	38°, 67°, 52°		
Beeper Operation:	7 tones or no beep		
Indicators (LED):	Red = good read		
	Green = laser on, ready to scan		
<b>MECHANICAL</b>			
Length:		170 mm (6.7")	
Width	Head:	63 mm (2.5")	
	Handle:	39 mm (1.5")	
Height	Head:	35 mm (1.4")	
	Handle:	31 mm (1.2")	
Weight:		100.8 g (3.56 oz)	

*Specifications subject to change without notice.*

<sup>▲</sup> Applicable for IBM<sup>®</sup> Host applications.

## DESIGN SPECIFICATIONS

		<b>MS5145 Eclipse</b>	
<b>ELECTRICAL</b>			
Input Voltage:	5VDC $\pm$ 0.25V		
Power:	Operating	675 mW	
Current:	Operating	135 mA average @ 5VDC	
DC Transformers:	Class II; 5.2VDC @ 1A		
<i>For regulatory compliance information, see pages 37 – 39.</i>			
<b>ENVIRONMENTAL</b>			
Temperature:	Operating	0°C to 40°C (32°F to 104°F)	
	Storage	-40°C to 60°C (-40°F to 140°F)	
Humidity:	5% to 95% relative humidity, non-condensing		
Light Levels:	Up to 4842 Lux (450 footcandles)		
Shock:	Designed to withstand 1.5 m (5 ft.) drops		
Contaminants:	Sealed to resist airborne particulate contaminants		
Ventilation:	None required		

*Specifications subject to change without notice.*

## APPLICATIONS AND PROTOCOLS

---

The model number on each scanner includes the scanner number and factory default communications protocol.

Scanner	Version Identifier	Communication Protocol(s)
MS5145	00	Laser Emulation
	11	RS485 <sup>▲</sup> RS232 - TXD, RXD, RTS, CTS
	38	Low Speed USB, Serial Emulation or Keyboard Emulation
	40	Full Speed USB
	41	RS232/Light Pen Emulation
	47	Keyboard Wedge
	48	Keyboard Wedge, Stand-Alone Keyboard

<sup>▲</sup> *Applicable for IBM<sup>®</sup> Host applications.*

The MS5145 Keyboard Wedge Series (-47) is designed for keyboard emulation only. Many RS232 configurable functions available in other Honeywell scanners are also available as keyboard wedge functions.

The following are the most important selectable options specific to keyboard wedge:

### Keyboard Type

- \*\*AT (includes IBM<sup>®</sup> PS2 models 50, 55, 60, 80)
- IBM PS2 (includes models 30, 70, 8556)

### Keyboard Country Type

- \*\*USA
- Belgium
- French
- German
- Hungarian
- Italian
- Japanese
- Russian Cyrillic
- Slovenian
- Spanish
- Swiss
- Swedish/Finnish
- Turkish
- United Kingdom

\*\* Indicates a default setting (see *pages 27 - 29 for additional information*). Refer to the MetroSelect Single-Line Configuration Guide (MLPN 00-02544) or MetroSet2's help files for information on how to change the default settings.

## DEFAULT SETTINGS

Many functions of the scanner can be *configured or enabled/disabled*. The scanner is shipped from the factory configured to a set of default conditions. All default parameters of the scanner have an asterisk ( \* ) marked in the default column. If an asterisk is not in the default column then the default setting is *off or disabled*. Every interface does not support every parameter. A check mark (✓) will appear in the interface column if the interface supports the parameter listed.

Parameter	Default	RS232	Light Pen	RS485 <sup>▲</sup>	KBW	USB	Laser Emulation
Normal Scan Mode	*	✓	✓	✓	✓	✓	✓
Continuous Scan Mode		✓	✓	✓	✓	✓	✓
Blinky Scan		✓	✓	✓	✓	✓	✓
Continuous Blinky Scan		✓	✓	✓	✓	✓	✓
Custom (One Shot) Scan		✓	✓	✓	✓	✓	✓
Manual Activation Mode		✓	✓	✓	✓	✓	✓
CodeGate Active	*	✓	✓	✓	✓	✓	✓
CodeGate Inactive		✓	✓	✓	✓	✓	✓
UPC/EAN	*	✓	✓	✓	✓	✓	✓
Code 128	*	✓	✓	✓	✓	✓	✓
Code 93	*	✓	✓	✓	✓	✓	✓
Codabar	*	✓	✓	✓	✓	✓	✓
Interleaved 2 of 5 (ITF)	*	✓	✓	✓	✓	✓	✓
MOD 10 Check on ITF		✓	✓	✓	✓	✓	✓
Code 11		✓	✓	✓	✓	✓	✓
Code 39	*	✓	✓	✓	✓	✓	✓
Full ASCII Code 39		✓	✓	✓	✓	✓	✓
Mod 43 Check on Code 39		✓	✓	✓	✓	✓	✓
MSI-Plessey 10/10 Check Digit		✓	✓	✓	✓	✓	✓
MSI-Plessey Mod 10 Check Digit	*	✓	✓	✓	✓	✓	✓
Paraf Support ITF		✓	✓	✓	✓	✓	✓

<sup>▲</sup> Applicable for IBM® Host applications.

## DEFAULT SETTINGS

Parameter	Default	RS232	Light Pen	RS485 <sup>▲</sup>	KBW	USB	Laser Emulation
ITF Symbol Lengths	Variable	✓	✓	✓	✓	✓	✓
Minimum Symbol Length	3	✓	✓	✓	✓	✓	✓
Symbol Length Lock	None	✓	✓	✓	✓	✓	✓
Bars High as Code 39	*		✓				✓
Spaces High as Code 39			✓				✓
Bars High as Scanned			✓				✓
Spaces High as Scanned			✓				✓
DTS/SIEMENS							
DTS/NIXDORF	*						
NCR F							
NCR S							
Poll Light Pen Source			✓				✓
Beeper Tone	Normal	✓	✓	✓	✓	✓	✓
Beep/Transmit Sequence	Before transmit	✓	✓	✓	✓	✓	✓
Communication Timeout	None	✓	✓	✓	✓	✓	✓
Razzberry Tone on Timeout		✓	✓	✓	✓	✓	✓
Three Beeps on Timeout		✓	✓	✓	✓	✓	✓
Same Symbol Rescan Timeout: 250 msec		✓	✓	✓	✓	✓	✓
Same Symbol Rescan Timeout: 375 msec		✓	✓	✓	✓	✓	✓
Same Symbol Rescan Timeout: 500 msec		✓	✓	✓	✓	✓	✓
Same Symbol Rescan Timeout: 625 msec		✓	✓	✓	✓	✓	✓
Same Symbol Rescan Timeout: 750 msec		✓	✓	✓	✓	✓	✓
Same Symbol Rescan Timeout: 875 msec	*	✓	✓	✓	✓	✓	✓
Same Symbol Rescan Timeout: 1000 msec		✓	✓	✓	✓	✓	✓
No Same Symbol Timeout		✓	✓	✓	✓	✓	✓

<sup>▲</sup> Applicable for IBM<sup>®</sup> Host applications.



## DEFAULT SETTINGS

Parameter	Default	RS232	Light Pen	RS485 <sup>▲</sup>	KBW	USB	Laser Emulation
Infinite Same Symbol Timeout		✓	✓	✓	✓	✓	✓
Inter-Character Delay Configurable In 1 msec steps (max 255 msec)	1 msec 10 msec in KBW	✓	✓	✓	✓	✓	✓
Number Of Scan Buffers ( <i>maximum</i> )	4	✓	✓	✓	✓	✓	✓
Transmit UPC-A Check Digit	*	✓	✓	✓	✓	✓	✓
Transmit UPC-E Check Digit		✓	✓	✓	✓	✓	✓
Expand UPC-E		✓	✓	✓	✓	✓	✓
Convert UPC-A to EAN-13		✓	✓	✓	✓	✓	✓
Transmit Lead Zero On UPC-E		✓	✓	✓	✓	✓	✓
Transmit UPC-A Number System	*	✓	✓	✓	✓	✓	✓
Transmit UPC-A Manufacturer ID#	*	✓	✓	✓	✓	✓	✓
Transmit UPC – A Item ID#	*	✓	✓	✓	✓	✓	✓
Transmit Codabar Start/Stop Characters		✓		✓	✓	✓	
CLSI Editing (Enable)		✓		✓	✓	✓	
Transmit Mod 43 Check digit on Code 39		✓		✓	✓	✓	
Transit Mod 10/ITF		✓		✓	✓	✓	
Transmit MSI-Plessy		✓		✓	✓	✓	
Parity	Space	✓		✓		✓	
Baud Rate	9600	✓					
8 Data Bits		✓					
7 Data Bits	*	✓					
Stop Bits	2	✓					

<sup>▲</sup> Applicable for IBM<sup>®</sup> Host applications.

## DEFAULT SETTINGS

Parameter	Default	RS232	Light Pen	RS485▲	KBW	USB	Laser Emulation
Transmit Sanyo ID Characters		✓			✓		
Nixdorf ID		✓			✓		
LRC Enabled		✓			✓		
UPC Prefix		✓			✓		
UPC Suffix		✓			✓		
Carriage Return	*	✓			✓		
Line Feed-Disabled by Default in KBW	*	✓			✓		
Tab Prefix		✓			✓		
Tab Suffix		✓			✓		
"DE" Disable Command		✓					
"FL" Laser		✓					
Enable Command		✓					
DTR Handshaking support		✓					
RTS/CTS Handshaking		✓					
Character	*	✓					
Message RTS/CTS		✓					
XON/XOFF Handshaking		✓					
ACK/NAK		✓					
Two Digit Supplements		✓	as code 39	✓	✓	✓	as code 39
Five Digit Supplements		✓	as code 39	✓	✓	✓	as code 39
Bookland		✓	as code 39	✓	✓	✓	as code 39
977 (2 digit) Supplemental Requirement		✓	✓	✓	✓	✓	✓
Supplements are not Required	*	✓	✓	✓	✓	✓	✓
Two Digit Redundancy	*	✓	✓	✓	✓	✓	✓
Five Digit Redundancy		✓	✓	✓	✓	✓	✓

▲ Applicable for IBM® Host applications.

## DEFAULT SETTINGS

Parameter	Default	RS232	Light Pen	RS485 <sup>▲</sup>	KBW	USB	Laser Emulation
100 msec to Find Supplement Configurable in 100 msec Steps (max 800 msec)	*	✓	✓	✓	✓	✓	✓
Coupon Code 128		✓	as code 39	✓	✓	✓	as code 39
† Configurable Code Lengths	7 avail	✓	✓	✓	✓	✓	✓
† Code Selects with Configurable Code Length Locks	3 avail	✓	✓	✓	✓	✓	✓
Configurable Prefix Characters	10 avail	✓			✓		
Suffix Characters	10 avail	✓			✓		
Prefixes for Individual Code Types		✓			✓		
Editing		✓	✓	✓	✓	✓	✓
Inter Scan-Code Delay Configurable (100 µsec steps)	800 µsec				✓		
Function/Control Key Support							
Minimum Element Width Configurable in 5.6 µsec Steps	1 msec		✓				✓

† These options are mutually exclusive. One cannot be used in conjunction with the other.

▲ *Applicable for IBM® Host applications.*

## UPGRADING THE FLASH ROM FIRMWARE

---

The MS5145 is part of Honeywell's line of scanners with flash upgradeable firmware. The upgrade process requires a new firmware file supplied to the customer by a customer service representative♦ and MetroSet2 software♦♦. A personal computer running Windows 95 or greater with an available RS232 serial or USB port is required to complete the upgrade.



PowerLink cable #54-54014 is required when using RS232 for the upgrade process. To order this cable contact a customer service representative. **Do not** use the standard cable supplied with keyboard wedge or RS485▲ scanner interface kits. If using USB for the upgrade process, the standard USB cable provided with the scanner can be used.

To upgrade the firmware in the MS5145:

1. Plug the scanner into a serial communication port on the host system.
2. Start the MetroSet2 software.
3. Click on the plus sign (+) next to *POS Scanners* to expand the supported scanner list.
4. Choose the MS5145 Eclipse from the list.
5. Click on the *Configure Eclipse/5145 Scanner* button.
6. Choose *Flash Utility* from the options list located on the left side of the screen.
7. Click on the *Open File* button in the Flash Utility window.
8. Locate and open the flash upgrade file.
9. Select the COM port that the scanner is connected to on the host system.
10. Verify the settings listed in the Flash Utility window.
11. Click on the *Flash Scanner* button to begin the flash upgrade.
12. A message will appear on the screen when the upgrade is complete.

- ♦ To contact a customer service representative, see page 44.
- ♦♦ MetroSet2 is available for download, at no additional cost, from [www.honeywell.com/aidc](http://www.honeywell.com/aidc).

▲ *Applicable for IBM® Host applications.*

## Scanner Pinout Connections

The MS5145 scanner interfaces terminate to a 10-pin modular jack. The serial number label indicates the interface enabled when the scanner is shipped from the factory.

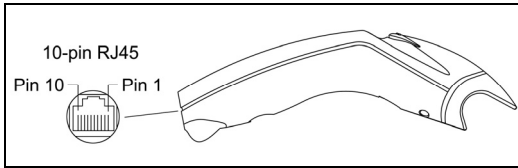

Figure 15.

MS5145-41 RS232C and Light Pen Emulation	
Pin	Function
1	Ground
2	RS232 Transmit Output
3	RS232 Receive Input
4	RTS Output
5	CTS Input
6	DTR Input/LTPN Source
7	Reserved
8	LTPN Data
9	+5VDC
10	Shield Ground

MS5145-47 Keyboard Wedge and Stand-Alone Keyboard	
Pin	Function
1	Ground
2	RS232 Transmit Output
3	RS232 Receive Input
4	PC Data
5	PC Clock
6	KB Clock
7	PC +5V
8	KB Data
9	+5VDC
10	Shield Ground

MS5145-11 RS485 <sup>▲</sup>	
Pin	Function
1	Ground
2	RS232 Transmit Output
3	RS232 Receive Input
4	RTS Output
5	CTS Input
6	DTR Input
7	IBM B-Transmit
8	IBM A+ Receive
9	+5VDC
10	Shield Ground

<sup>▲</sup> Applicable for IBM<sup>®</sup> Host applications.

# SCANNER AND CABLE TERMINATIONS

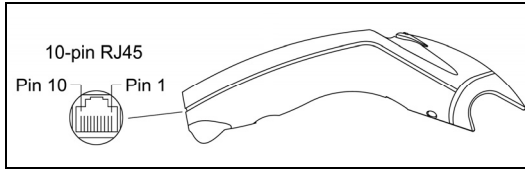



Figure 16.

MS5145-00 Laser Emulation	
Pin	Function
1	Ground
2	RS232 Transmit Output
3	RS232 Receive Input
4	Flip Sense/Start of Scan Output
5	Proximity Detect/ Trigger Emulation Output
6	Scan/Laser Enable Input
7	Reserved
8	Data Out
9	+5VDC
10	Shield Ground



MS5145 Full Speed (-40) and Low Speed (-38) USB	
Pin	Function
1	Ground
2	N/C
3	N/C
4	N/C
5	N/C
6	D+
7	PC +5V/V_USB
8	D-
9	N/C
10	Drain Wire

# SCANNER AND CABLE TERMINATIONS

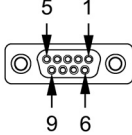

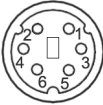
## Cable Connector Configurations

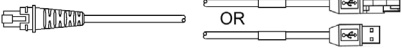
RS232 PowerLink Cable, 55-55000.x-3		
Pin	Function	 <p>9-Pin D-Type Connector</p>
1	Shield Ground	
2	RS232 Transmit Output	
3	RS232 Receive Input	
4	DTR Input/Light Pen Source	
5	Power/Signal Ground	
6	Light Pen Data (DSR Out for -14 interfaces)	
7	CTS Input	
8	RTS Output	
9	+5VDC	

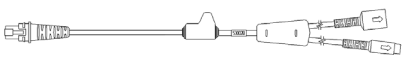

Stand Alone Keyboard PowerLink Cable, 55-55020x-3		
Pin	Function	 <p>6-Pin Male Mini-DIN Connector</p>
1	PC Data	
2	NC	
3	Power Ground	
4	+5VDC PC Power to KB	
5	PC Clock	
6	NC	

USB Communication 55-55235.x-N-3 or 55-55200.x-N-3		
Pin	Function	 <p>Non-Locking, Type A MLPN 54-54214.x-N-3</p>
1	PC +5V/V_USB	
2	D-	
3	D+	
4	Ground	
Shield	Shield	 <p>Locking, Type A MLPN 54-54213.x-N-3 or MLPN 54-54214.x-N-3</p>

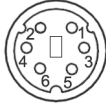
**Cable Connector Configuration**

Keyboard Wedge PowerLink Cable 55-55002A-3		
<b>Pin</b>	<b>Function</b>	 <p>5-Pin DIN, Female</p>
1	Keyboard Clock	
2	Keyboard Data	
3	No Connect	
4	Power Ground	
5	+5 Volts DC	 <p>6-Pin DIN, Male</p>
<b>Pin</b>	<b>Function</b>	
1	PC Data	
2	No Connect	
3	Power Ground	
4	+5 Volts DC	
5	PC Clock	
6	No Connect	

An adapter cable with a 5-pin DIN male connector on one end and a 6-pin mini DIN female connector on the other will be supplied. According to the termination required, connect the appropriate end of the adapter cable to the PowerLink cable, leaving the necessary termination exposed for connecting to the keyboard and the keyboard port on the PC.

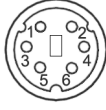
Keyboard Wedge Adapter Cable		
<b>Pin</b>	<b>Function</b>	 <p>5-Pin DIN, Male</p>
1	PC Clock	
2	PC Data	
3	No Connect	
4	Power Ground	
5	+5 Volts DC	 <p>6-pin Mini DIN, Female</p>
<b>Pin</b>	<b>Function</b>	
1	Keyboard Data	
2	No Connect	
3	Power Ground	
4	+5 Volts DC	
5	Keyboard Clock	
6	No Connect	



## Safety

### ITE Equipment

IEC 60950-1, EN 60950-1

### Laser

Laser Class 1: IEC 60825-1:1993+A1+A2,  
EN 60825-1:1994+A1+A2



#### **⚠ Caution**

Use of controls or adjustments or performance of procedures other than those specified herein may result in hazardous laser light exposure. Under no circumstances should the customer attempt to service the laser scanner. Never attempt to look at the laser beam, even if the scanner appears to be nonfunctional. Never open the scanner in an attempt to look into the device. Doing so could result in hazardous laser light exposure. The use of optical instruments with the laser equipment will increase eye hazard.

#### **⚠ Atención**

La modificación de los procedimientos, o la utilización de controles o ajustes distintos de los especificados aquí, pueden provocar una luz de láser peligrosa. Bajo ninguna circunstancia el usuario deberá realizar el mantenimiento del láser del escáner. Ni intentar mirar al haz del láser incluso cuando este no esté operativo. Tampoco deberá abrir el escáner para examinar el aparato. El hacerlo puede conllevar una exposición peligrosa a la luz de láser. El uso de instrumentos ópticos con el equipo láser puede incrementar el riesgo para la vista.

#### **⚠ Attention**

L'emploi de commandes, réglages ou procédés autres que ceux décrits ici peut entraîner de graves irradiations. Le client ne doit en aucun cas essayer d'entretenir lui-même le scanner ou le laser. Ne regardez jamais directement le rayon laser, même si vous croyez que le scanner est inactif. N'ouvrez jamais le scanner pour regarder dans l'appareil. Ce faisant, vous vous exposez à une rayonnement laser qui est dangereux. L'emploi d'appareils optiques avec cet équipement laser augmente le risque d'endommagement de la vision.

#### **⚠ Achtung**

Die Verwendung anderer als der hier beschriebenen Steuerungen, Einstellungen oder Verfahren kann eine gefährliche Laserstrahlung hervorrufen. Der Kunde sollte unter keinen Umständen versuchen, den Laser-Scanner selbst zu warten. Sehen Sie niemals in den Laserstrahl, selbst wenn Sie glauben, daß der Scanner nicht aktiv ist. Öffnen Sie niemals den Scanner, um in das Gerät hineinzusehen. Wenn Sie dies tun, können Sie sich einer gefährlichen Laserstrahlung aussetzen. Der Einsatz optischer Geräte mit dieser Laserausrüstung erhöht das Risiko einer Sehschädigung.

#### **⚠ Attenzione**

L'utilizzo di sistemi di controllo, di regolazioni o di procedimenti diversi da quelli descritti nel presente Manuale può provocare delle esposizioni a raggi laser rischiose. Il cliente non deve assolutamente tentare di riparare egli stesso lo scanner laser. Non guardate mai il raggio laser, anche se credete che lo scanner non sia attivo. Non aprite mai lo scanner per guardare dentro l'apparecchio. Facendolo potete esporvi ad una esposizione laser rischiosa. L'uso di apparecchi ottici, equipaggiati con raggi laser, aumenta il rischio di danni alla vista..

## EMC

### Emissions

FCC Part 15, ICES-003, CISPR 22, EN 55022

### Immunity

CISPR 24, EN 55024

NOTE: Immunity performance is not guaranteed for scanner cables greater than 3 meters in length when fully extended.

Changes or modifications not expressly approved by the party responsible for compliance could void the user's authority to operate the equipment.

### Class A Devices

**The following is applicable when the scanner cable is greater in length than 3 meters (9.8 feet) when fully extended:**

**Les instructions ci-dessous s'appliquent aux cables de scanner dépassant 3 mètres (9.8 pieds) de long en extension maximale:**

**Folgendes trifft zu, wenn das Scannerkabel länger als 3 Meter ist:**

This equipment has been tested and found to comply with limits for a Class A digital device, pursuant to part 15 of the FCC Rules. These limits are designed to provide reasonable protection against harmful interference when the equipment is operated in a commercial environment. This equipment generates, uses and can radiate radio frequency energy and, if not installed and used in accordance with the instruction manual, may cause harmful interference to radio communications. Operation of this equipment in a residential area is likely to cause harmful interference, in which case the user will be required to correct the interference at their own expense. Any unauthorized changes or modifications to this equipment could void the user's authority to operate this device.

This device complies with part 15 of the FCC Rules. Operation is subject to the following two conditions: (1) This device may not cause harmful interference, and (2) this device must accept any interference received, including interference that may cause undesired operation.

### Notice

This Class A digital apparatus complies with Canadian ICES-003.

### Remarque

Cet appareil numérique de classe A est conforme à la norme canadienne NMB-003.

### European Standard

#### Warning

This is a class A product. In a domestic environment this product may cause radio interference in which case the user may be required to take adequate measures.

### Funkstöreigenschaften nach EN55022:1998

#### Warnung!

Dies ist eine Einrichtung der Klasse A. Diese Einrichtung kann im Wohnbereich Funkstörungen verursachen. In diesem Fall kann vom Betreiber verlangt werden, angemessene Massnahmen durchzuführen.

### EMC

Changes or modifications not expressly approved by the party responsible for compliance could void the user's authority to operate the equipment.

#### Standard Europeo

##### Attenzione

Questo e' un prodotto di classe A. Se usato in vicinanza di residenze private potrebbe causare interferenze radio che potrebbero richiedere all'utilizzatore opportune misure.

##### Attention

Ce produit est de classe "A". Dans un environnement domestique, ce produit peut être la cause d'interférences radio. Dans ce cas l'utilisateur peut être amené à prendre les mesures adéquates.

### Class B Devices

**The following is applicable when the scanner cable is less than 3 meters (9.8 feet) in length when fully extended:**

**Les instructions ci-dessous s'appliquent aux cables de scanner ne dépassant pas 3 mètres (9.8 pieds) de long en extension maximale:**

**Folgendes trifft zu, wenn das Scannerkabel kürzer als 3 Meter ist:**

This device complies with Part 15 of the FCC Rules. Operation is subject to the following two conditions: (1) This device may not cause harmful interference, and (2) this device must accept any interference received, including interference that may cause undesired operation.

This equipment has been tested and found to comply with the limits for a Class B digital device, pursuant to Part 15 of the FCC rules. These limits are designed to provide reasonable protection against harmful interference in a residential installation. This equipment generates, uses and can radiate radio frequency energy and, if not installed and used in accordance with the instructions, may cause harmful interference to radio communications. However, there is no guarantee that interference will not occur in a particular installation. If this equipment does cause harmful interference to radio or television reception, which can be determined by turning the equipment off and on, the user is encouraged to try to correct the interference by one or more of the following measures:

- Reorient or relocate the receiving antenna
- Increase the separation between the equipment and receiver
- Connect the equipment into an outlet on a circuit different from that to which the receiver is connected
- Consult the dealer or an experienced radio/TV technician for help

#### Notice

This Class B digital apparatus complies with Canadian ICES-003.

#### Remarque

Cet appareil numérique de classe B est conforme à la norme canadienne NMB-003.

## LIMITED WARRANTY

---

Honeywell International Inc. ("HII") warrants its products and optional accessories ("Accessories") to be free from defects in materials and workmanship and to conform to HII's published specifications applicable to the products purchased at the time of shipment. This warranty does not cover any HII product which is (i) improperly installed or used; (ii) subjected to abuse, misuse or neglect; (iii) subjected to improper hardware or software installation or configuration; (iv) damaged by accident or negligence, including failure to follow the proper maintenance, service, and cleaning schedule; or (v) damaged as a result of (A) modification or alteration by the purchaser or other party, (B) excessive voltage or current supplied to or drawn from the interface connections, (C) static electricity or electro-static discharge, (D) operation under conditions beyond the specified operating parameters, (E) repair or service of the product by anyone other than HII or its authorized representatives, or (F) a failure to follow instructions contained in this manual or other documentation provided by HII. The warranty is void if (i) the case of the Product is opened by anyone other than HII's repair department or authorized repair centers; or (ii) any software is installed on the Product other than a software program approved by HII.

This warranty shall extend from the date of manufacture for the duration published by HII for the product at the time of purchase ("Warranty Period"). Any defective product must be returned (at purchaser's expense) during the Warranty Period to a HII factory or authorized service center for inspection, as set forth on page 40. No product will be accepted by HII without a Return Materials Authorization, which may be obtained by contacting HII (see page 45). In the event that the product is returned to HII or its authorized service center within the Warranty Period and HII determines to its satisfaction that the product is defective due to defects in materials or workmanship, HII, at its sole option, will either repair or replace the product without charge, except for return shipping to HII.

EXCEPT AS MAY BE OTHERWISE PROVIDED BY APPLICABLE LAW, THE FOREGOING WARRANTY IS IN LIEU OF ALL OTHER COVENANTS OR WARRANTIES, EITHER EXPRESSED OR IMPLIED, ORAL OR WRITTEN, INCLUDING, WITHOUT LIMITATION, ANY IMPLIED WARRANTIES OF MERCHANTABILITY, FITNESS FOR A PARTICULAR PURPOSE OR NON-INFRINGEMENT.

HII'S RESPONSIBILITY AND PURCHASER'S EXCLUSIVE REMEDY UNDER THIS WARRANTY IS LIMITED TO THE REPAIR OR REPLACEMENT OF THE DEFECTIVE PRODUCT WITH NEW OR REFURBISHED PARTS. IN NO EVENT SHALL HII BE LIABLE FOR INDIRECT, INCIDENTAL, OR CONSEQUENTIAL DAMAGES, AND, IN NO EVENT, SHALL ANY LIABILITY OF HII ARISING IN CONNECTION WITH ANY PRODUCT SOLD HEREUNDER (WHETHER SUCH LIABILITY ARISES FROM A CLAIM BASED ON CONTRACT, WARRANTY, TORT, OR OTHERWISE) EXCEED THE ACTUAL AMOUNT PAID TO HII FOR THE PRODUCT. THESE LIMITATIONS ON LIABILITY SHALL REMAIN IN FULL FORCE AND EFFECT EVEN WHEN HII MAY HAVE BEEN ADVISED OF THE POSSIBILITY OF SUCH INJURIES, LOSSES, OR DAMAGES. SOME STATES, PROVINCES, OR COUNTRIES DO NOT ALLOW THE EXCLUSION OR LIMITATIONS OF INCIDENTAL OR CONSEQUENTIAL DAMAGES, SO THE ABOVE LIMITATION OR EXCLUSION MAY NOT APPLY TO YOU.

All provisions of this Limited Warranty are separate and severable, which means that if any provision is held invalid and unenforceable, such determination shall not affect the validity of enforceability of the other provisions hereof. Use of any peripherals not provided by the manufacturer may result in damage not covered by this warranty. This includes but is not limited to: cables, power supplies, cradles, and docking stations. HII extends these warranties only to the first end-users of the products. These warranties are non-transferable.

The duration of the limited warranty for the MS5145 is three year(s). The Accessories have a 90 day limited warranty from the date of manufacture.

## PATENTS

---

This Honeywell product may be covered by, but not limited to, one or more of the following US Patents:

U.S. Patent No.;

5,216,232; 5,260,553; 5,340,971; 5,424,525; 5,484,992; 5,525,789; 5,528,024;  
5,616,908; 5,627,359; 5,661,292; 5,777,315; 5,789,730; 5,789,731; 5,811,780;  
5,828,048; 5,925,870; 6,029,894; 6,209,789; 6,227,450; 6,283,375; 6,347,743;  
6,607,133; 6,619,549; 6,874,689; 6,975,456; 6,976,632; 7,017,813; 7,044,383;  
7,124,950; 7,156,310;

No license, right or sublicense is granted, either expressly or by implication, estoppel, or otherwise, under any Metrologic, Honeywell or third party intellectual property rights (whether or not such third party rights are licensed to Metrologic and/or Honeywell), including any third party patent listed above, except for an implied license only for the normal intended use of the specific equipment, circuits, and devices represented by or contained in the products that are physically transferred to the user, and only to the extent of those license rights and subject to any conditions, covenants and restrictions therein.

Other worldwide patents pending.

## INDEX

---

### A

AC ..... *see power*  
accessories ..... 2, 3  
aperture ..... 4

### B

beeper ..... *see indicator*  
button ..... 4, 12  
Button ..... 32

### C

cable ..... 20–21, 36, 33–36  
    communication.. 2, 3, 6, 7–11, 22,  
    27  
    MVC..... 3  
    PowerLink ..... 6, 7–11, 36, 33–36  
    USB ..... 11  
caution ..... 37  
    compliance..... 37–39  
    SELV..... 37–39  
class ..... 39  
CodeGate ..... 4, 12  
compliance ..... 5, 37, 38  
configuration.. 26, 27–31, 36, 33–36  
customer service ..... 3, 40

### D

DC ..... *see power*  
default..... 7, 18, 19, 26, 27–31  
depth of field..... 16

### E

EMC ..... 38  
EMI ..... 38  
emissions ..... 38

### F

flash..... 1

### G

green ..... *see indicator*

### I

immunity ..... 38  
indicator..... 24

audible..... 4, 13, 20–21  
failure..... 15, 20–21  
visual ..... 4, 14, 20–21  
interface ..... 24  
    Keyboard Wedge. 1, 3, 9, 26, 27–  
    31, 33, 36  
    Laser Emulation ..... 7, 27–31, 34  
    Light Pen ..... 1, 7, 26, 27–31, 33  
    RS232 . 1, 2, 7, 26, 27–31, 33, 35  
    RS485 ..... 1, 8, 26, 27–31, 33  
    Stand-Alone Keyboard ... 1, 3, 10,  
    26, 33, 35  
    USB..... 1, 2, 3, 26, 27–31, 34, 35

### K

Keyboard Wedge ..... *see interface*

### L

label ..... 5  
laser ..... 4, 5, 24, 37  
LED ..... *see indicator*  
Light Pen..... *see interface*

### M

manual ..... 2  
modes ..... 12, 17

### N

notices ..... 39

### O

operation ..... 39

### P

parameter..... 27–31  
power ..... 2, 3, 7, 24  
PowerLink ..... *see cable*

### R

razzberry tone ..... 28  
red..... *see indicator*  
RMA..... 40  
RS232 ..... *see interface*  
RS485..... *see interface*

## INDEX

---

### **S**

safety ..... 37, 39  
stand ..... 3  
Stand-Alone Keyboard *see interface*

### **T**

terminations ..... 33–36  
tone ..... 1, 13  
transformer ..... *see power*  
troubleshooting ..... 20–21

### **U**

USB ..... *see interface*

### **V**

VLD ..... 24

### **W**

warranty ..... 40  
window ..... 4

# CONTACT INFORMATION

## The Americas (TA)

### USA

Tel: 866.460.8033 (Customer Service)  
888.633.3762 (Technical Support)  
856.228.8100 (Corporate)  
Fax: 856.228.6673 (Sales)  
856.228.1879 (Marketing)  
856.228.0653 (Legal/Finance)

### Brazil

Tel: 55.11.5185.8222  
Fax: 55.11.5185.8225  
Email: [info@br.metrologic.com](mailto:info@br.metrologic.com)

### Mexico

Tel: 55.5365.6247  
Fax: 55.5362.2544  
Email: [info@mx.metrologic.com](mailto:info@mx.metrologic.com)

### North America

Tel: 856.537.6400  
866.460.8033 (Customer Service)  
888.633.3762 (Technical Support)  
Fax: 856.537.6474  
Email: [info@us.metrologic.com](mailto:info@us.metrologic.com)

### South America (Outside Brazil)

Tel: 55.11.5182.7273  
Fax: 55.11.5182.7198  
Email: [info@sa.metrologic.com](mailto:info@sa.metrologic.com)

### Omniplanar, Inc.

Tel: 856.374.5550  
Fax: 856.374.5576  
Email: [info@omniplanar.com](mailto:info@omniplanar.com)

### NOVODisplay

Tel: 856.537.6139  
Fax: 856.537.6116  
Email: [info@NOVODisplay.com](mailto:info@NOVODisplay.com)

## Europe, Middle East and Africa

### France

Tel: +33 (0) 1 48.63.78.78  
Fax: +33 (0) 1 48.63.24.94  
Email: [info@fr.metrologic.com](mailto:info@fr.metrologic.com)

### Germany

Tel: 49-89-89019-0  
Fax: 49-89-89019-200  
Email: [info@de.metrologic.com](mailto:info@de.metrologic.com)

### Italy

Tel: +39 0 51 6511978  
Fax: +39 0 51 6521337  
Email: [info@it.metrologic.com](mailto:info@it.metrologic.com)

### Poland

Tel: +48 (22) 545 04 30  
Fax: +48 (22) 545 04 31  
Email: [info@pl.metrologic.com](mailto:info@pl.metrologic.com)

### Russia

Tel: +7 (495) 737 7273  
Fax: +7 (495) 737 7271  
Email: [info@ru.metrologic.com](mailto:info@ru.metrologic.com)

### Spain

Tel: +34 913 272 400  
Fax: +34 913 273 829  
Email: [info@es.metrologic.com](mailto:info@es.metrologic.com)

### United Kingdom

Tel: +44 (0) 1256 365900  
Fax: +44 (0) 1256 365955  
Email: [info@uk.metrologic.com](mailto:info@uk.metrologic.com)

## Asia Pacific

### Australia

Tel: 1 800 99 88 38  
Fax: +61 2 8916-6471  
Email: [info@au.metrologic.com](mailto:info@au.metrologic.com)

### China

Tel: 86-21-58356616  
86-21-58358830  
Fax: 86-21-58358873  
Email: [info@cn.metrologic.com](mailto:info@cn.metrologic.com)

### Suzhou Sales Office

Tel: 86-512-67622550  
Fax: 86-512-67622560  
Email: [info@cn.metrologic.com](mailto:info@cn.metrologic.com)

### Guangzhou Sales Office

Tel: 86-20-38823476  
Fax: 86-20-38823477  
Email: [info@cn.metrologic.com](mailto:info@cn.metrologic.com)

### Beijing Sales Office

Tel: 010-82253472/84583280  
Fax: 010-82253648/84583102  
Email: [info@cn.metrologic.com](mailto:info@cn.metrologic.com)

### Chengdu Sales Office

Tel: 028-66135066/86786348  
Fax: 028-86787061  
Email: [info@cn.metrologic.com](mailto:info@cn.metrologic.com)

### Hong Kong

Tel: 852-2331-9133 (main line)  
Fax: 852-2511-3557

### India

India Sales Office  
Tel: +91 80 4125 6718  
Fax: +91 80 4125 6719  
Email: [info@in.metrologic.com](mailto:info@in.metrologic.com)

### Japan

Tel: 81-3-3839-8511  
Fax: 81-3-3839-8519  
Email: [info@jp.metrologic.com](mailto:info@jp.metrologic.com)

### Korea

Korea Sales Office  
Tel: (82) 2-6205-5379  
(82) 11-9363-5379 (mobile)  
Fax: (82)-2-3444-3980  
Email: [info@kr.metrologic.com](mailto:info@kr.metrologic.com)

### Singapore

Tel: (65) 6842-7155  
Fax: (65) 6842-7166  
Email: [info@sg.metrologic.com](mailto:info@sg.metrologic.com)

### Thailand

Tel: +662-610-3787  
Fax: +662-610-3601  
Email: [info@th.metrologic.com](mailto:info@th.metrologic.com)



# PRODUCT SERVICE AND REPAIR

---

**North America**

Tel: 866.460.8033  
Fax: 856.228.6673 (Sales)  
Email: [info@metrologic.com](mailto:info@metrologic.com)

**Suzhou Sales Office**

Tel: 86-512-67622550  
Fax: 86-512-67622560  
Email: [info@cn.metrologic.com](mailto:info@cn.metrologic.com)

**European Repair Center**

Tel: +34 913 751 249  
Fax: +34 913 270 437





January 2009

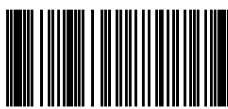

7 0 - 7 9 0 1 6 E

## Free Manuals Download Website

<http://myh66.com>

<http://usermanuals.us>

<http://www.somanuals.com>

<http://www.4manuals.cc>

<http://www.manual-lib.com>

<http://www.404manual.com>

<http://www.luxmanual.com>

<http://aubethermostatmanual.com>

Golf course search by state

<http://golfingnear.com>

Email search by domain

<http://emailbydomain.com>

Auto manuals search

<http://auto.somanuals.com>

TV manuals search

<http://tv.somanuals.com>