

Honeywell

OWNER'S MANUAL

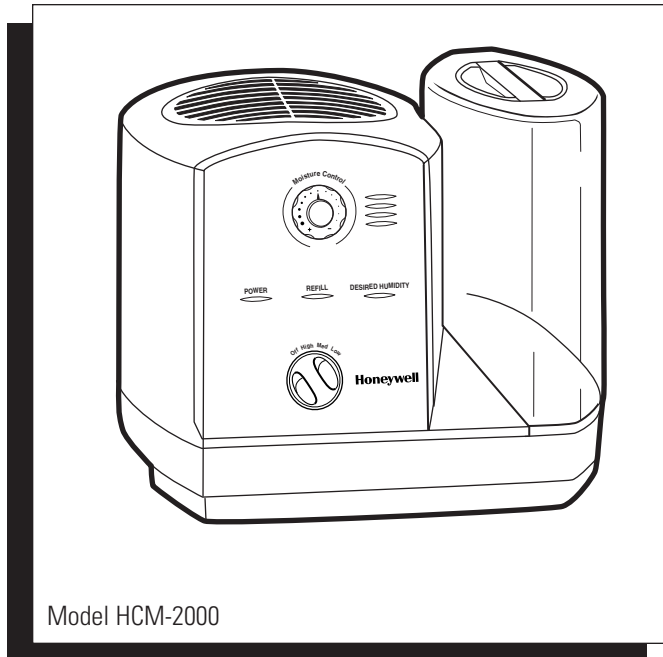

Model HCM-2000

COOL MOISTURE HUMIDIFIER

Models HCM-1000/2000 Series

IMPORTANT SAFETY INSTRUCTIONS

READ ALL INSTRUCTIONS BEFORE USING THIS HUMIDIFIER AND SAVE THESE IMPORTANT INSTRUCTIONS FOR EASY REFERENCE.

WHEN USING ANY ELECTRICAL APPLIANCE, BASIC SAFETY PRECAUTIONS SHOULD BE FOLLOWED, INCLUDING:

1. Always place this humidifier on a firm, flat and level surface. This humidifier may not work properly on an uneven surface.
2. **CAUTION:** To reduce the risk of burns, place this humidifier in an area where it is not accessible to children.
3. Do not place the humidifier near any heat sources such as stoves, radiators and heaters.
4. Before using the humidifier, check the power cord for any signs of damage. If the cord is found to be damaged, **DO NOT USE** and return the humidifier to Honeywell under the warranty agreement for repair.
5. This product is equipped with a polarized AC-line plug (a plug having one blade wider than the other). This plug will fit into the power outlet only one way. **This is a safety feature. NEVER** connect the humidifier to any power source other than a 120V AC polarized outlet. If you are unable to insert the plug fully into the outlet, try reversing the plug. If the plug should still fail to fit, contact an electrician to replace the obsolete outlet. **DO NOT defeat the safety purpose of the polarized plug.**
6. A loose fit between the AC outlet and plug may cause overheating of the plug. Have a qualified electrician replace the outlet.
7. The humidifier should always be unplugged and emptied when not in operation or while being serviced or cleaned.
8. Never tilt or attempt to move the humidifier while it is operating or filled with water. **UNPLUG** the humidifier before moving.
9. This humidifier requires regular cleaning. Refer to the CLEANING instructions provided. Never clean the humidifier in any manner other than as instructed in this manual.
10. Turn the humidifier OFF if the relative humidity exceeds 60%, or if you notice moisture on the inside of your windows. For proper humidity readings use a hygrometer, which is available in many hardware and department stores, or by ordering one from Honeywell (see Replacement Parts and Care Products-Digital Humidity Temperature Indicator).

INTRODUCTION

Thank you for purchasing a HONEYWELL COOL MOISTURE HUMIDIFIER.

Before using your humidifier, we would like to explain the benefits of maintaining your home or office at the proper humidity level.

HEALTH

Your body needs moisture to stay healthy and comfortable. Dry air can be damaging and irritating. The Honeywell Cool Moisture Humidifier may help relieve:

- Dry, itchy skin and chapped lips.
- Cold symptoms and congestion.
- Dry, scratchy throat and coughs.

For serious medical conditions, always consult your physician prior to use.

ENVIRONMENT

Maintaining the proper moisture level in your home or office with your Honeywell Cool Moisture Humidifier may also:

- Replace needed moisture in furniture.
- Keep indoor plants moist and healthy.
- Eliminate cracking and dryness in wood furniture and fixtures.
- Minimize static electricity.

HOW DOES IT WORK?

Dry air is pulled through the Cool Moisture system and a quiet fan disperses invisible, moisture-balanced air. There is no "mist" or excessive condensation emitted.

SET-UP

- Select a firm, level location—at least six inches (15 cm) from any wall for proper air flow and convenient to an electrical outlet.
- Place the humidifier on a water-resistant surface, as water can damage furniture and some flooring. **Honeywell will not accept responsibility for property damage caused by water spillage.**

FILLING

- We recommend that the humidifier be disinfected prior to first use. Please see CLEANING instructions.
- Remove the water tank by grasping handle and pulling straight up. Set aside (Fig. 1).
- Lift off the motor housing. Remove the Cool Moisture filter pad from the base before filling the unit with water (Fig. 2). Run it under cold water; this will help reduce residue build-up. Turn the filter upside down before repositioning it in the humidifier. Place it back in the humidifier wet.

Do not squeeze or wring out the filter. To help extend the life of your filter, repeat this step every time you fill your humidifier.

- Turn the Water Tank upside-down so that the fill cap is facing up.
- Fill the Water Tank with COOL tap water (Fig. 3). Distilled water is not necessary as the water is filtered by the Cool Moisture filter. DO NOT USE HOT WATER.
- Replace the fill cap .

CAUTION: WHEN CARRYING THE FILLED WATER TANK, PLEASE USE THE HANDLE AND PLACE YOUR OTHER HAND UNDER THE TANK FOR ADDITIONAL SUPPORT.

- Turn Water Tank right-side up.
- Position Water Tank in the humidifier and push it into place.
- Some water will empty into the Reservoir Base when the filled Water Tank is properly positioned.
- Once the filled tank has been positioned, do not attempt to move the humidifier. If it has to be moved, unplug the humidifier and remove the Water Tank first.

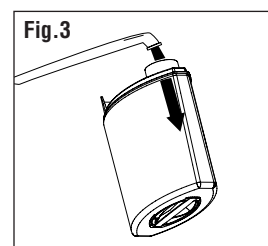
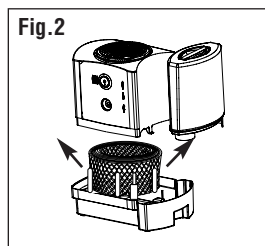
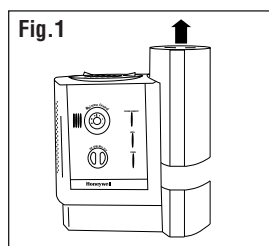

OPERATION

WARNING: DO NOT POUR WATER INTO THE GRILL ON THE TOP OF THE MOTOR HOUSING. DOING SO MAY DAMAGE THE HUMIDIFIER OR CAUSE PERSONAL INJURY.

- With the power switch in the OFF position, plug the filled humidifier into a polarized 120V outlet.

WARNING: DO NOT FORCE THE POLARIZED PLUG INTO THE OUTLET; it will only fit one way.

WARNING: DO NOT PLUG IN THE HUMIDIFIER WITH WET HANDS AS AN ELECTRIC SHOCK COULD OCCUR.

- Keep the Moisture Control (Humidistat) on HIGH - the largest black dot before "+" sign (Fig. 4).
- Set the speed control to the desired position:
 - HIGH for fast humidifying, MED for everyday moisture control, or LOW for night time operation.

NOTE: IF THE HUMIDIFIER FAN WILL NOT START OR RESTART WHEN YOU SELECT A FAN SPEED, THE HUMIDISTAT MAY BE SET TOO LOW. MOVING THE HUMIDITY LEVEL KNOB TO A HIGHER SETTING (THE LARGEST BLACK DOT BEFORE THE "+" SIGN) SHOULD RESTART THE FAN.

- When a comfortable humidity level is reached, lower the Moisture Control (Humidistat) setting slowly by turning the knob clockwise until the fan stops (Fig. 4). The DESIRED HUMIDITY light will illuminate, indicating that the desired humidity setting has been reached. The Humidistat will automatically restart the fan each time the humidity level falls below this setting. This "ON/OFF" cycle will continue periodically while the humidifier is in use.
- ALWAYS be sure to discard any unused water in the base each time you refill the Water Tank or finish using the humidifier (Fig. 5).

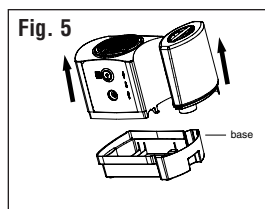
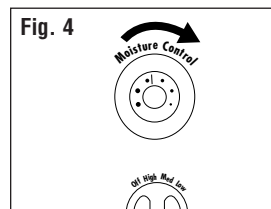

OTHER FEATURES

- If you have the HCM-2000 series models, your humidifier will have the Auto-Shut off feature.
- When your water tank is empty, your humidifier will automatically shut itself off as an added safety feature.
- The Refill/Restart light will illuminate indicating it is time to refill your water tank.

CLEANING

- We recommend that you clean the humidifier once a week, or more often if you:
 - have hard water,
 - notice a build-up of impurities, or
 - detect unpleasant odours.

NOTE: THE USE OF OTHER WATER TREATMENT PRODUCTS MAY CAUSE DETERIORATION OF THE FILTER OR DAMAGE THE HUMIDIFIER, THEREBY HINDERING THE HUMIDIFIER'S EFFECTIVENESS.

DO NOT USE SOAP, DETERGENTS, OR ABRASIVE CLEANSERS.

- Cleaning involves two steps: SCALE REMOVAL and DISINFECTING. Be sure to perform these in the proper order to avoid harmful chemical interactions.
- First, turn off and unplug the humidifier.
- Then remove the Water Tank by grasping the handle and pulling straight up (Fig. 6).
- Lift the motor housing up off the reservoir base. Set aside; reach in and remove the Cool Moisture filter (Fig. 7). Set aside.
- Discard any residual water from the base.

STEP ONE: WEEKLY SCALE REMOVAL (RESERVOIR BASE)

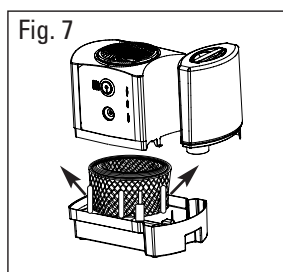
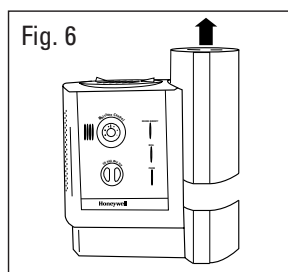

CLEANING CONTINUED

- Fill the Reservoir Base with one 8-oz. (250ml) cup of undiluted white vinegar. Let solution stay for 20 minutes.
- With vinegar still in the unit, clean all interior surfaces of the base with a soft brush or cloth to remove scale.
- Rinse Reservoir Base thoroughly with clean, warm water to remove scale and cleaning solution.

STEP TWO: WEEKLY DISINFECTING (WATER TANK, RESERVOIR BASE)

- Empty the water tank. Refill with 1 teaspoon of chlorine bleach in 1 gallon (4 litres) water. Let solution stay in the tank 20 minutes, swishing every few minutes to wet all surfaces.
- Empty tank after 20 minutes. Rinse with water until bleach smell is gone.
- Repeat for the Reservoir Base.

AFTER DISINFECTING

- Clean all surfaces of the power unit with a dry, soft cloth. **WARNING: DO NOT USE WATER TO CLEAN THE POWER UNIT. THIS MAY DAMAGE THE HUMIDIFIER OR CAUSE ELECTRIC SHOCK.**
- If you have hard water, you may need to clean or change the filter more often. If the filter is dirty, rinse it under cold tap water and turn the filter upside down before repositioning in the base. Do not squeeze or wring out pad. Do not soak pad in bleach or vinegar.

When the filter turns dark brown, replace it. For best and proven results always use Honeywell Cool Moisture filters available from your local store or from Honeywell.

- Reposition the Filter, Motor Housing and Water Tank.

NOTE: THE FAN MOTOR OF THIS HUMIDIFIER AND THE COOL MOISTURE FILTER ARE DESIGNED TO FUNCTION EFFICIENTLY AS A SET. USING ANY OTHER FILTER COULD DAMAGE THE HUMIDIFIER'S MOTOR OR IMPAIR ITS PERFORMANCE.

END-OF-SEASON CARE AND STORAGE

- Follow weekly CLEANING instructions at end of humidification season or when humidifier will not be used for at least one week or more. Remove and throw away the filter; do not store with a used filter.
- Let humidifier dry completely before storing. Do not store with water inside the Reservoir Base or water tank.
- Pack the unit in its original carton and store in a cool, dry location.
- Remember to install a new filter and clean the humidifier at the start of the next humidification season.

ELECTRICAL RATINGS

Models HCM-1000 Series are rated 0.45 Amps at 120V, 60 Hz.

Models HCM-2000 Series are rated 0.6 Amps at 120V, 60 Hz.

WARNING: IF YOU EXPERIENCE A PROBLEM WITH YOUR HUMIDIFIER'S POWER UNIT, PLEASE SEE THE WARRANTY FOR INSTRUCTIONS. PLEASE DO NOT ATTEMPT TO OPEN OR REPAIR THE HUMIDIFIER YOURSELF. DOING SO MAY VOID THE WARRANTY AND COULD CAUSE DAMAGE OR PERSONAL INJURY. IF THE PROBLEM STILL PERSISTS, PLEASE CALL:

HONEYWELL INC.
CUSTOMER SERVICE DEPARTMENT

TOLL FREE: 1-800-332-1110

Mail questions or
comments to:

HONEYWELL INC.
Consumer Relations Dept.
250 Turnpike Road
Southborough, MA
01772
U.S.A.

Please be sure to specify model number.

REPLACEMENT PARTS AND CARE PRODUCTS

To order replacement parts or care products, complete and mail the enclosed Order Form. Be sure to include a check or money order payable to Honeywell Inc. or call the Honeywell Customer Service Department on our toll-free number: 1-800-332-1110. VISA®, MASTERCARD® and DISCOVER® are accepted. The following prices do not include shipping charges or sales tax where applicable.

NOTE: These fit HCM-1000 and HCM-2000 series products

Item	Item No.	US Price	CAN Price
Cool Moisture Replacement Filter	HAC-500	\$14.00	\$18.90
Digital Humidity/Temperature Indicator (measures room humidity level)	HAC-555	\$19.99	\$26.98
Water Tank and Fill Cap (HCM-1000 series)	HCM-1000-1	\$19.99	\$26.98
Water Tank and Fill Cap (HCM-2000 series)	HCM-2000-1	\$19.99	\$26.98
Fill Cap	HCM-2000-2	\$ 9.99	\$13.50

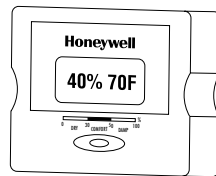
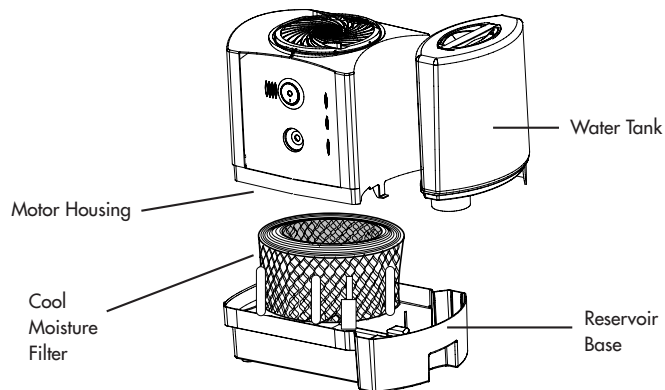

Digital Humidity/Temperature Indicator

ORDER FORM MODELS HCM-1000/2000 SERIES

REPLACEMENT PARTS AND CARE PRODUCTS

If your local dealer is out of stock, Honeywell replacement parts and care products may be ordered directly. Fill out the form and mail it along with a check or money order (no cash, please) to Honeywell Inc. at the address shown below. Please allow four weeks for delivery. Massachusetts residents add 5% Sales Tax. Canadian residents add 7% G.S.T. and applicable provincial taxes.

Item	Item No.	Quantity	Price U.S.	Price Can	Total
Cool Moisture Replacement Filter	HAC-500		\$ 14.00	\$18.90	
Digital Humidity / Temperature Indicator	HAC-555		\$ 19.99	\$26.98	
Water Tank and Fill Cap (for HCM-1000 Series)	HCM-1000-1		\$ 19.99	\$26.98	
Water Tank and Fill Cap (for HCM-2000 Series)	HCM- 2000-1		\$ 19.99	\$26.98	
Fill Cap	HCM-2000-2		\$ 9.99	\$13.50	

Parts and accessories subject to availability. Prices may change without notice.

CHECK OR MONEY ORDER ENCLOSED. NO COD'S ACCEPTED.

SEND TO:
 Honeywell Inc.
 Customer Service Department
 250 Turnpike Road
 Southborough, MA 01772 U.S.A.

SUBTOTAL	
MA residents add 5% Sales Tax	
Add 7% G.S.T. and applicable provincial taxes	
Shipping and Handling \$10.00 US/\$13.50 CAN	
TOTAL ENCLOSED	

Name _____

Address _____

Day time phone no. () _____

In case we need to contact you about your order.

Or for MasterCard®, Visa® and Discover® orders:

Cardholder name (please print): _____

Cardholder signature: _____

Card Number: _____ Expiration Date: _____

Please Check: MasterCard® Visa® Discover®

LIMITED WARRANTY

HONEYWELL COOL MOISTURE HUMIDIFIER

This product has been engineered and crafted with great care for your satisfaction.

Please read all instructions before attempting to use this product. Be sure to fill out and return the enclosed card within 7 days of purchase.

A. This 5 year limited warranty applies to repair or replacement of product found to be defective in material or workmanship. This warranty does not apply to damage resulting from commercial, abusive, unreasonable use or supplemental damage. Defects that are the result of normal wear and tear will not be considered manufacturing defects under this warranty. **HONEYWELL IS NOT LIABLE FOR INCIDENTAL OR CONSEQUENTIAL DAMAGES OF ANY NATURE. ANY IMPLIED WARRANTY, INCLUDING MERCHANTABILITY AND FITNESS FOR A PARTICULAR PURPOSE, ON THIS PRODUCT IS LIMITED IN DURATION TO THE DURATION OF THIS WARRANTY.** Some jurisdictions do not allow the exclusion or limitation of incidental or consequential damages, or limitations on how long an implied warranty lasts, so the above limitations or exclusions may not apply to you. This warranty gives you specific legal rights, and you also may have other rights which vary from jurisdiction to jurisdiction. This warranty applies only to the original purchaser of this product from the original date of purchase.

B. At its option, Honeywell will repair or replace this product if it is found defective in material or workmanship. Defective product should be returned directly to Honeywell.

C. This warranty does not cover damage resulting from any unauthorized attempts to repair or from any use not in accordance with this manual.

D. Return defective product to the place of purchase in accordance with store policy or to the following address with a brief description of the problem. Include proof of purchase and a U.S. \$10.00/\$13.50 CAN check or money order for handling, return packing and shipping charges. Please include your name, address and a daytime phone number. You must prepay shipping charges. Mark carton "Attention Returns Department." Ship to: Honeywell Inc.

ATTN: Returns Department
Southpoint Distribution Center
4755 Southpoint Drive
Memphis, TN 38118
U.S.A.
1-800-332-1110

NOTE: THIS WARRANTY DOES NOT COVER THE COOL MOISTURE FILTER, WHOSE PERFORMANCE WILL DEPEND UPON THE CONDITION OF THE WATER USED IN THE HUMIDIFIER.

P/N 035-00358-000

©1999 All rights reserved. Honeywell Inc.HU4032.99

Free Manuals Download Website

<http://myh66.com>

<http://usermanuals.us>

<http://www.somanuals.com>

<http://www.4manuals.cc>

<http://www.manual-lib.com>

<http://www.404manual.com>

<http://www.luxmanual.com>

<http://aubethermostatmanual.com>

Golf course search by state

<http://golfingnear.com>

Email search by domain

<http://emailbydomain.com>

Auto manuals search

<http://auto.somanuals.com>

TV manuals search

<http://tv.somanuals.com>