

V2652 Optimal-plus MANUAL RADIATOR VALVE

PRODUCT DATA

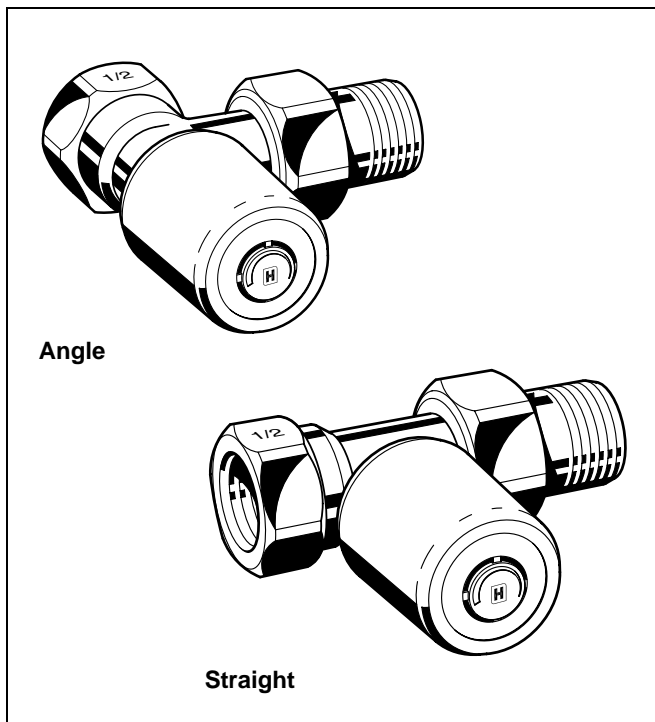

Design

The manual radiator valves consists of:

- Valve housing PN10, DN10, 15 or 20 with
 - internal thread connection to DIN2999 (ISO7) for threaded, copper or precision steel pipe on inlet (compression ring fittings see 'Accessories')
 - external thread connection to DIN/ISO228 with union-nut and radiator tailpiece on outlet
- Valve insert
- Handwheel

Materials

- Valve housing made of nickel-plated red bronze
- Valve insert made of brass with EPDM O-rings
- Handwheel made of white plastic
- Threaded tailpiece and connection nut made of nickel-plated brass

Application

Optimal-plus manual valves are installed on the supply of radiators and heat exchangers in warm water heating systems. Control of the room temperature is done by manually opening or closing the valve.

Features

- Convertible to thermostatic control, also when installed and in operation
- Robust valve housing made of corrosion resistant red bronze with good flow and sound properties
- Maintenance-free spindle sealing
- Valve housing with dimensions according to EN215, Appendix A, Series D
- Non-rising handwheel
- Connection to all types of pipe DN10...DN20

Specifications

Medium	Heating water, water quality to VDI2035	
pH-value	8...9.5	
Operating temperature	max. 90°C (194°F)	
Operating pressure	PN 10	
k_v(cv)-values	Angle DN10	2.1 (2.46)
	Angle DN15	2.3 (2.69)
	Angle DN20	2.7 (3.16)
	Straight DN10	1.7 (1.99)
	Straight DN15	1.8 (2.11)
	Straight DN20	2.2 (2.57)
Leakage rate	≤ 0.01 % of k _v -value	
Thermostat connection	M30 x 1.5	

Function

The orifice between valve seat and valve cartridge increases when the valve is opened by turning the handwheel anti-clockwise. More heating water can flow into the radiator or heat exchanger and the room temperature rises.

The orifice between valve seat and valve cartridge decreases when the valve is closed by turning the handwheel clockwise and the supply of heating water into the radiator or heat exchanger is throttled. At the right limit stop the valve is closed except for a possible leakage rate.

Please Note:

- To avoid stone deposit and corrosion the composition of the medium should conform with VDI-Guideline 2035
- Additives have to be suitable for EPDM sealings
- System has to be flushed thoroughly before initial operation with all valves fully open
- Any complaints or costs resulting from non-compliance with above rules will not be accepted by Honeywell
- Please contact us if you should have any special requirements or needs

Dimensions and Ordering Information

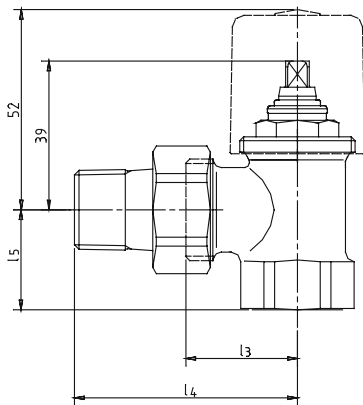

Fig. 1. Angle

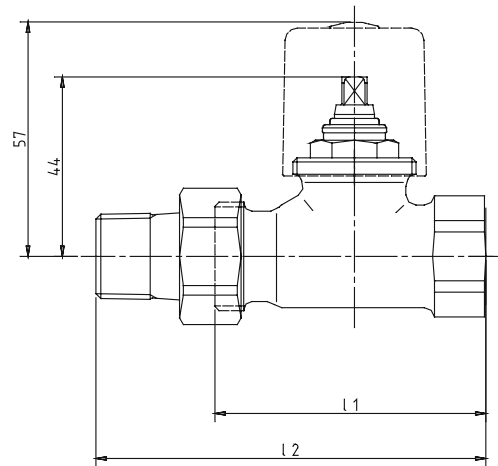

Fig. 2. Straight

Table 1. Dimensions and OS-Nos. (OS=Order Specification)

Type	DN	Pipe connection	k _{vs} (cv)-value	l ₁	l ₂	l ₃	l ₄	l ₅	OS-No.
Angle (Fig. 1)	10	Rp 3/8"	2.1 (2.46)	—	—	26	52	22	V2652E0010
	15	Rp 1/2"	2.3 (2.69)	—	—	29	58	26	V2652E0015
	20	Rp 3/4"	2.7 (3.16)	—	—	34	66	29	V2652E0020
Straight (Fig. 2)	10	Rp 3/4"	1.7 (1.99)	59	85	—	—	—	V2652D0010
	15	Rp 1/2"	1.8 (2.11)	66	95	—	—	—	V2652D0015
	20	Rp 3/4"	2.2 (2.57)	74	106	—	—	—	V2652D0020

NOTE: All dimensions in mm unless stated otherwise.

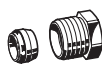

Accessories

Compression ring and nut



	3/8" x 10 mm	VA620A1010
	3/8" x 12 mm	VA620A1012
	1/2" x 10 mm	VA620A1510
	1/2" x 12 mm	VA620A1512
	1/2" x 14 mm	VA620A1514
	1/2" x 15 mm	VA620A1515
	1/2" x 16 mm	VA620A1516
	3/4" x 18 mm	VA620A2018
	3/4" x 22 mm	VA620A2022

NOTE: Support inserts have to be used for copper or soft steel pipe with 1.0 mm wall thickness

Compression ring and nut with support insert (2 pcs each)

	3/8" x 12 mm	VA621A1012
	1/2" x 12 mm	VA621A1512
	1/2" x 15 mm	VA621A1515
	1/2" x 16 mm	VA621A1516
	3/4" x 18 mm	VA621A2018

Compression ring and nut with support insert for composite pipe (2 pcs each)

	1/2" x 14 mm	VA622B1514
	1/2" x 16 mm	VA622B1516

Reduction piece

	1" pipe > 1/2" valve	VA6290A260
	1 1/4" pipe > 1/2" valve	VA6290A280
	1" pipe > 3/4" valve	VA6290A285
	1 1/4" pipe > 3/4" valve	VA6290A305

Radiator tailpiece with thread up to collar

	for valves DN10 (3/8")	VA5201A010
	for valves DN15 (1/2")	VA5201A015
	for valves DN20 (3/4")	VA5201A020

Extended radiator tailpiece, nickel-plated, to be shortened as required

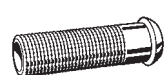
	3/8" x 70 mm (for DN10) thread approx. 50 mm	VA5204A010
	1/2" x 76 mm (for DN15) thread approx. 65 mm	VA5204A015
	3/4" x 70 mm (for DN20) thread approx. 60 mm	VA5204A020

Soldering tailpiece

	3/8" x 12 mm (for DN10)	VA5230A010
	1/2" x 15 mm (for DN15)	VA5230A015
	3/4" x 22 mm (for DN20)	VA5230A020

Pressure cap – for closing of radiator outlet valves

	for valves DN10 (3/8")	VA2202A010
	for valves DN15 (1/2")	VA2202A015
	for valves DN20 (3/4")	VA2202A020

Sealing ring for pressure cap

	for valves DN10 (3/8")	VA5090A010
	for valves DN15 (1/2")	VA5090A015
	for valves DN20 (3/4")	VA5090A020

Service tool to replace valve insert

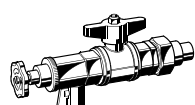
	for all sizes	VA8200A001
---	---------------	------------

Automation and Control Solutions

Honeywell GmbH

Hardhofweg

74821 Mosbach, Germany

Phone: +49 (6261) 810

Fax: +49 (6261) 81393

www.honeywell.com

EN0H-2119GE25 R1106
November 2006

© 2006 Honeywell International Inc.
Subject to change • All rights reserved

Manufactured for and on behalf of the Environmental and Combustion
Controls Division of Honeywell Technologies Sàrl, Ecublens,
Route du Bois 37, Switzerland or by its Authorized Representative.

Honeywell

Free Manuals Download Website

<http://myh66.com>

<http://usermanuals.us>

<http://www.somanuals.com>

<http://www.4manuals.cc>

<http://www.manual-lib.com>

<http://www.404manual.com>

<http://www.luxmanual.com>

<http://aubethermostatmanual.com>

Golf course search by state

<http://golfingnear.com>

Email search by domain

<http://emailbydomain.com>

Auto manuals search

<http://auto.somanuals.com>

TV manuals search

<http://tv.somanuals.com>