

# **HRDP DVR**

## **Performance Series Digital Recording and Transmission System**

### **User Guide**

## Warnings and Safeguards

**Revisions**

---

<b>Issue</b>	<b>Date</b>	<b>Revisions</b>
A	05/08	Initial Release
B	06/08	Updated remote control image

---

## Warnings and Safeguards

# Warnings and Safeguards

---

## FCC STATEMENT

---

This equipment has been tested and found to comply with the limits for a Class A digital device, pursuant to Part 15 of the FCC Rules. These limits are designed to provide reasonable protection against harmful interference when the equipment is operated in a commercial environment. This equipment generates, uses, and can radiate radio frequency energy and, if not installed and used in accordance with the instruction manual, may cause harmful interference to radio communications. Operation of this equipment in a residential area is likely to cause harmful interference in which case the user will be required to correct the interference at his own expense.

---

## EN 55022 Class A Notice

---

### WARNING

This is a class A product. In a domestic environment this product may cause radio interference in which case the user may be required to take adequate measures.

## Important Safeguards

---

1. **Read Owner's Manual** – After unpacking this product, read the owner's manual carefully, and follow all the operating and other instructions.
2. **Power Sources** – This product should be operated only from the type of power source indicated on the label. If not sure of the type of power supply to your home or business, consult product dealer or local power company
3. **Ventilation** – Slots and openings in the cabinet are provided for ventilation and to ensure reliable operation of the product and to protect it from overheating, and these openings must not be blocked or covered. The product should not be placed in a built-in installation such as a bookcase or rack unless proper ventilation is provided or Honeywell's instructions have been adhered to.
4. **Heat** – The product should be situated away from heat sources such as radiators, heat registers, stoves, or other products that produce heat.
5. **Water and Moisture** – Do not use this product near water. Do not exceed the humidity specifications for the product as detailed in this manual
6. **Cleaning** – Unplug this product from the wall outlet before cleaning. Do not use liquid cleaners or aerosol cleaners. Use a damp cloth for cleaning.
7. **Power Cord Protection** – Power-supply cords should not be routed so that they are likely to be walked on or pinched by items placed against them, paying particular attention to cords at plugs, receptacles, and the point where they exit the product.
8. **Overloading** – Do not overload wall outlets; extension cords, or integral convenience receptacles as this can result in a risk of fire or electrical shock.
9. **Lightning** – For added protection for this product during storm, or when it is left unattended and unused for long periods of time, unplug it from the wall outlet. This will prevent damage to the product due to lightning and power line surges.
10. **Object and Liquid Entry Points** – Never insert foreign objects into the DVR, other than the media types approved by Honeywell, as they may touch dangerous voltage points or short-out parts that could result in a fire or electrical shock. Never spill liquid of any kind on the product.
11. **Accessories** – Do not place this product on an unstable cart, stand, tripod, bracket, or table. The product may fall, causing serious personal injury and serious damage to the product.
12. **Disc Tray** – Keep fingers well clear of the disc tray as it is closing. Neglecting to do so may cause serious personal injury.
13. **Burden** – Do not place a heavy object on or step on the product. The object may fall, causing serious personal injury and serious damage to the product.
14. **Disc** – Do not use a cracked, deformed, or repaired disc. These discs are easily broken and may cause serious personal injury and product malfunction.
15. **Fuses** - CAUTION: For continued protection against risk of fire, replace only with same type and rating of fuse.

16. **Replaceable Batteries** - CAUTION: Risk of Risk of Explosion if Battery is replaced by an Incorrect Type. Dispose of Used Batteries According to the Instructions
17. **Grounded Outlet** - This equipment shall be connected to a properly grounded outlet."
18. **Outlet Location** – This equipment must be installed within six feet of an easily accessible outlet.
19. **Damage Requiring Service** – Unplug the unit from the outlet and refer servicing to qualified service personnel under the following conditions:
  - When the power-supply cord or plug is damaged.
  - If liquid has been spilled, or objects have fallen into the unit.
  - If the unit has been exposed to rain or water.
  - If the unit does not operate normally by following the operating instructions. Adjust only those controls that are covered by the operating instructions as an improper adjustment of other controls may result in damage and will often require extensive work by a qualified technician to restore the unit to its normal operation.
  - If the unit has been dropped or the enclosure has been damaged.
  - When the unit exhibits a distinct change in performance - this indicates a need for service.
20. **Servicing** – Do not attempt to service this product. Opening or removing covers may expose the user to dangerous voltage or other hazards. Refer all servicing to qualified personnel.
21. **Replacement Parts** – When replacement parts are required, be sure the service technician has used replacement parts specified by Honeywell. Unauthorized substitutions may result in fire, electric shock or other hazards.
22. **Safety Check** – Upon completion of any service or repairs to this unit, ask the service technician to perform safety checks to determine that the unit is in proper operating condition.

## Notes on Handling

---

Please retain the original shipping carton and/or packing materials supplied with this product. To ensure the integrity of this product when shipping or moving, repackage the unit as it was originally received from Honeywell.

Do not use volatile liquids, such as aerosol spray, near this product. Do not leave rubber or plastic objects in contact with this product for long periods of time. They will leave marks on the finish.

The top and rear panels of the unit may become warm after long periods of use. This is not a malfunction.

---

## Notes on Locating

---

Place the unit on a level surface. Do not use it on a shaky or unstable surface such as a wobbling table or inclined stand.

If this unit is placed next to a TV, radio, or VCR, the playback picture may become poor and the sound may be distorted. If this happens, place the DVR away from the TV, radio, or VCR.

---

## Notes on Cleaning

---

Use a soft dry cloth for cleaning.

For stubborn dirt, soak the cloth in a weak detergent solution, wring well and wipe. Use a dry cloth to wipe it dry. Do not use any type of solvent, such as thinner and benzene, as they may damage the surface of the DVR.

If using a chemical saturated cloth to clean the unit, follow that product's instructions.

---

## Notes on Maintenance

---

This DVR is designed to last for long periods of time. To keep the DVR always operational we recommend regular inspection maintenance (cleaning parts or replacement). For details contact the nearest dealer.

---



---

## Notes on Moisture Condensation

---

Moisture condensation could damage the DVR. Read the following information carefully.

Moisture condensation might occur under the following circumstances:

When this product is brought directly from a cool location to a warm location.

When this product is moved to a hot and humid location from a cool location.

When this product is moved to a cool and humid location from a warm location.

When this product is used in a room where the temperature fluctuates.

When this product is used near an air-conditioning unit vent

When this product is used in a humid place.

### **Do not use the DVR when moisture condensation may occur.**

If the DVR is used in such a situation, it may damage discs and internal parts. Remove any CD discs, connect the power cord of the DVR to the wall outlet, turn on the DVR, and leave it for two to three hours. After two to three hours, the DVR will warm up and evaporate any moisture. Keep the DVR connected to the wall outlet and moisture will seldom occur.

---

## Safety Instructions – Rack Mount

---

A) Elevated Operating Ambient – If installed in a closed or multi-unit rack assembly, the operating ambient temperature of the rack environment may be greater than room ambient. Therefore, consideration should be given to installing the equipment in an environment compatible with the maximum ambient temperature (T<sub>ma</sub>) specified by the manufacturer.

B) Reduced Air Flow – Installation of the equipment in a rack should be such that the amount of air flow required for safe operation of the equipment is not compromised.

C) Mechanical Loading – Mounting of the equipment in the rack should be such that a hazardous condition is not achieved due to uneven mechanical loading.

D) Circuit Overloading - Consideration should be given to the connection of the equipment to the supply circuit and the effect that overloading of the circuits might have on overcurrent protection and supply wiring. Appropriate consideration of equipment nameplate ratings should be used when addressing this concern.

E) Reliable Earthing - Reliable earthing of rack-mounted equipment should be maintained. Particular attention should be given to supply connections other than direct connections to the branch circuit (e.g. use of power strips)."

## WARNING

---

TO REDUCE THE RISK OF ELECTRICAL SHOCK, DO NOT EXPOSE THIS APPLIANCE TO RAIN OR MOISTURE.  
DANGEROUS HIGH VOLTAGES ARE PRESENT INSIDE THE ENCLOSURE.  
DO NOT OPEN THE CABINET.  
REFER SERVICING TO QUALIFIED PERSONNEL ONLY.

---

## CAUTION

---

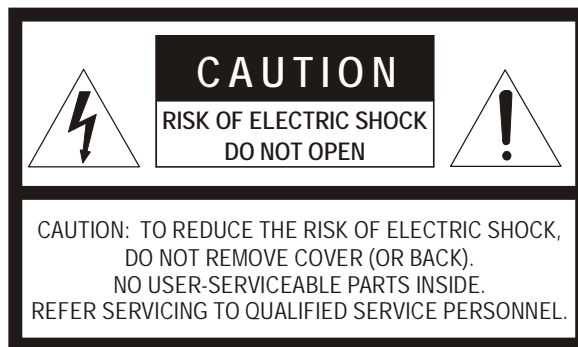

# Contents

<b>1 Warnings and Safeguards .....</b>	<b>5</b>
<b>2 Contents .....</b>	<b>11</b>
<b>3 Introduction .....</b>	<b>15</b>
Product Description .....	15
Features .....	16
PTZ Compatibility List .....	17
Quick Start Guide .....	18
Logging In for the First Time .....	18
<b>4 Installation .....</b>	<b>19</b>
Front Panel Controls .....	19
Rear Panel Connectors .....	20
4 Channel .....	20
8 Channel .....	21
16 Channel .....	21
Remote Control .....	22
Connection Guide .....	23
Connecting the Monitor .....	23
Video Inputs and Looping Outputs .....	23
Connecting to a Network .....	23
Connecting Audio .....	23
Connecting a PTZ Camera .....	24
Connecting to a Sensor Input .....	24
Connecting to a Relay Output .....	24
Installing the Rackmount Kit (optional) .....	25
Turning on the DVR .....	25
<b>5 Setup .....</b>	<b>27</b>
Setup Menus .....	27
System .....	28
System Configuration .....	28
Setup Wizard .....	29
Disk Configuration .....	30

Format .....	30
Overwrite .....	31
Check .....	31
SMART Check .....	32
User Configuration.....	33
Server .....	33
Client.....	34
Configuration .....	35
Shutdown.....	35
Camera.....	35
Camera Configuration .....	35
Color Setup (Adjust).....	36
PTZ Configuration.....	36
Spot / Sequence Configuration.....	37
Monitor Configuration.....	38
Record.....	39
Record Configuration .....	39
Frame.....	39
Schedule.....	40
Audio .....	40
Instant Recording .....	41
Using Instant Recording .....	41
Motion/Event Configuration.....	42
Input.....	42
Setting Up Motion Detection Recording .....	43
Sensor .....	44
Action.....	45
Alarm Monitor .....	45
Network .....	46
Network Configuration.....	46
Serial Configuration .....	47
Client Configuration.....	48
E-mail Configuration.....	49
Information .....	50
System Log View .....	50
Status View .....	50
Version View .....	51
<b>6 Operation.....</b>	<b>52</b>
Search .....	52
Searching Recorded Data .....	52
Search Methods .....	53
Express Search .....	53
Event Search .....	53
Daylight Savings Search .....	53
Go To First.....	54
Go To Last.....	54

Go To Jump.....	54
Search Details.....	54
Search Popup Menu.....	54
Monitoring .....	55
Select Channel .....	55
Live Popup Menu.....	56
Backup (Export) .....	57
Manual Export.....	57
Play Back Backup Image.....	58
S/W Upgrade.....	58
Save Settings .....	59
Save Settings.....	59
Import Settings .....	59
PTZ Camera Control .....	60
Create PTZ Preset Position .....	60
<b>7 Remote Software.....</b>	<b>62</b>
Set Up a Remote Connection.....	62
Configuring the DVR.....	62
Configuring a Remote PC.....	63
Default Remote Software Log In Information.....	63
Access Remote Connection .....	64
Using the Remote Software .....	64
Setting the Time and Date.....	64
Live View Screen .....	65
Camera View .....	66
Screen Division Buttons.....	67
Setup Overview.....	68
Setup Screen Overview.....	68
Camera Setup .....	68
Camera Setup .....	68
PanTilt Setup.....	68
Sequence Setup .....	69
SPOT Setup .....	69
Record Setup .....	69
Time Setup.....	69
Schedule Setup.....	70
Audio Setup .....	70
Motion / Event Input.....	70
HDD Setup.....	71
Sensor Setup.....	71
Sensor .....	71
System Setup .....	72
User Management.....	72
Firmware Upgrade .....	72

- Search Overview..... 73
  - Play Controls ..... 74
  - Performing a Basic Search ..... 74
  - Adjust the Brightness of an Image..... 74
  - Zooming in on an Image..... 74
  - Zooming in on a Portion of an Image ..... 75
  - Printing an Image ..... 75
  - Save Clip ..... 75
    - Saving a Video Clip..... 76
- Status Search ..... 77
  - Performing a Status Search ..... 77
- PTZ Overview..... 78
  - Accessing PTZ Menus ..... 78
  - Controlling a PTZ Camera..... 78
  - Using the Graphical PTZ Controller ..... 79
  - Using the On-screen Compass..... 80
- Web Viewer Overview ..... 81
  - Connecting to a DVR Using Web Viewer ..... 82
  - Closing the Web Viewer ..... 82
- Digital Verifier Overview ..... 83
  - Using the Digital Verifier ..... 83
- 8 Appendix ..... 84**
  - DVR FAQ ..... 84
    - General ..... 84
    - Live Monitoring ..... 84
    - Recording ..... 84
    - Searching and Playing Video ..... 85
    - Backup..... 85
    - Network..... 85
    - Miscellaneous ..... 85
  - Troubleshooting ..... 86
  - Specifications (HRDP) ..... 87

# Introduction

---

## Product Description

---

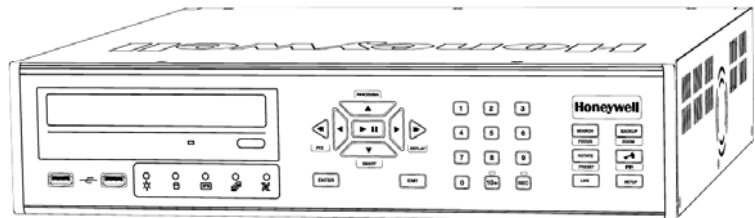

Honeywell's HRDP Performance Series DVR is a powerful, yet affordable, video management solution designed for easy installation and operation. Preconfigured for continuous recording, with no additional setup required, the Performance Series DVR offers quick search, setup, and backup features.

The Honeywell Embedded DVR comes ready for fast and seamless integration within your existing IT infrastructure. The HRDP offers unparalleled stability, security, and ease of use in a 2U chassis. Accordingly, your security investment has never been easier to maintain. Multiple users may connect through digital networks such as LANs and WANs for simultaneous live viewing, and digital search. This powerful software enables users to view live video, perform searches, and operate PTZ cameras. It also provides system users and administrators with additional capabilities such as establishing recording schedules, and creating motion detection zones. With the latest advancements in the Performance Series DVR software, searching and indexing your video archive has never been easier.

## Features

---

The Honeywell Performance Series DVRs include the following features:

- 4 / 8 / 16 Composite Video Input Connectors
- Compatible with Color (NTSC or PAL) and B&W Video Sources
- Multiple Search Methods (Date/Time, Calendar, Event)
- Records 120 NTSC Images Per Second / 100 PAL Images Per Second
- Live Real Time Video Display (480 NTSC Images Per Second / 400 PAL Images Per Second)
- 4 / 8 / 16 Looping Video Outputs
- Auto Termination (75 Ohm) on Looping Outputs
- Continuous Recording with Disk Overwrite Mode
- Continuous Recording on Archiving, Transmitting to Remote, and Playback
- Motion Based Recording Uniquely Configurable for Each Channel
- Customizable Motion Detection Grids Uniquely Configurable for Each Channel
- Multiple Recording Modes (Manual / Schedule / Event)
- Audio (Mono) Recording and Playback
- 4 / 8 / 16 Built in Sensor Inputs (Normally Open or Normally Closed)
- 1 / 4 (16 Channel DVR only) Built in Relay Outputs (Normally Open or Normally Closed)
- Remote Access via Ethernet and/or Modem
- PTZ Camera Control
- Internal DVD-RW supports CD-RW and DVD-RW media



---

## PTZ Compatibility List

---

The Honeywell Performance Series DVRs support a wide selection of PTZ camera protocols:

Honeywell MAXPRO	HMC-250
Honeywell VCL	HSCP
Honeywell (GC-655P)	Inter-M (VRX-2101)
Honeywell (HSD-250)	Inter-M (VSD-640)
Honeywell (HSD-251)	LG (LPT-A100L)
American Dynamics	LG (LVC-A70x s)
OpenEye 500	LG SpeedDome
OpenEye 510	Merit Li-Lin
OpenEye – Pelco D	Merit Li-Lin V6
AcutVista	NVCC-Z42N
AlfaVision	NICE CAM
KalatelDome	NIKO
Cynix Speed Dome	Pelco-D
CoVi EVQ-1000	Pelco-P
CRR-1600I	PIH-7600
DMP23-H2	SAE
Dongyang	Samsung (SCC-C420X)
DRX-500	Samsung (DVR-502A)
DRX-502A	Samsung (MRX-1000)
DS120	Samsung (SCC-641)
DSC-230/240	Samsung (SPD-1600)
DY-255RXB	Sensormatic
DynaColor	Sungjin
ERNA Tech	Tamron
EyeView Dome	Toshiba
FastraxII	ViconSpeedDome
FilTech (DSC-230/PT-201)	Visiontech
Focvision	WONWOO
Ganz-PT	WSD-7425D

## Quick Start Guide

---

1. Turn on the DVR. See the Turning on the DVR section for more details.
2. Log in -- Use the number buttons to enter the password when prompted – The password is <none> – Press ENTER.
3. Complete System Configuration to set up the date, time and system ID. See the System Configuration section for more details.
4. Complete Sensor Configuration to enable any external devices connected to sensor inputs or relay outputs. See the Motion/Event Configuration section for more details.
5. Complete Disk Configuration to set overwrite options and enable SMART Check. See the Disk Configuration section for more details.
6. Complete User Configuration to change the Admin password and add additional users. See the System >User Configuration section for more details.
7. Complete Camera Configuration for all attached cameras. See the Camera Configuration section for more detail.
8. Complete PTZ Configuration for any attached Pan / Tilt / Zoom cameras. See the PTZ Configuration section for more details.
9. Create a recording schedule. See the Record section for more details.
10. Complete Motion/Event Configuration to trigger recording on an event: motion, sensor, video loss. See the Motion/Event Configuration section for more details.
11. The DVR is now configured to record, search and playback video. See the Operations section in this manual for more information on using the DVR.

---

## Logging In for the First Time

---

The default administrative log in information:

**ID:** admin  
**Password:** <none>

# Installation

## Front Panel Controls

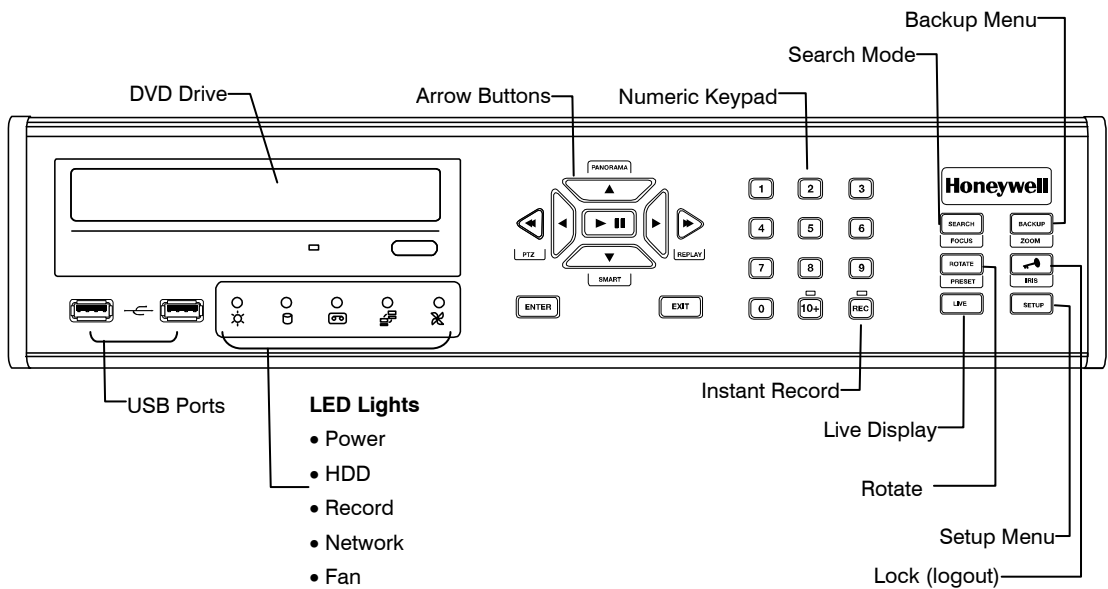

# Rear Panel Connectors

The rear panel of the DVR contains virtually all of the connectors you will be using. The diagrams below outline the location and description of each connector:

## 4 Channel

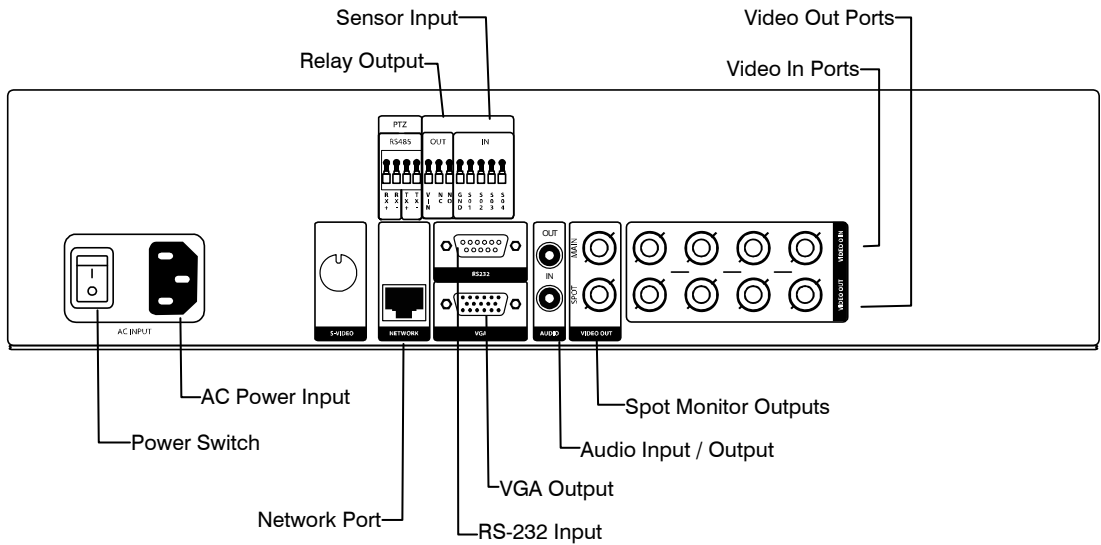

## 8 Channel

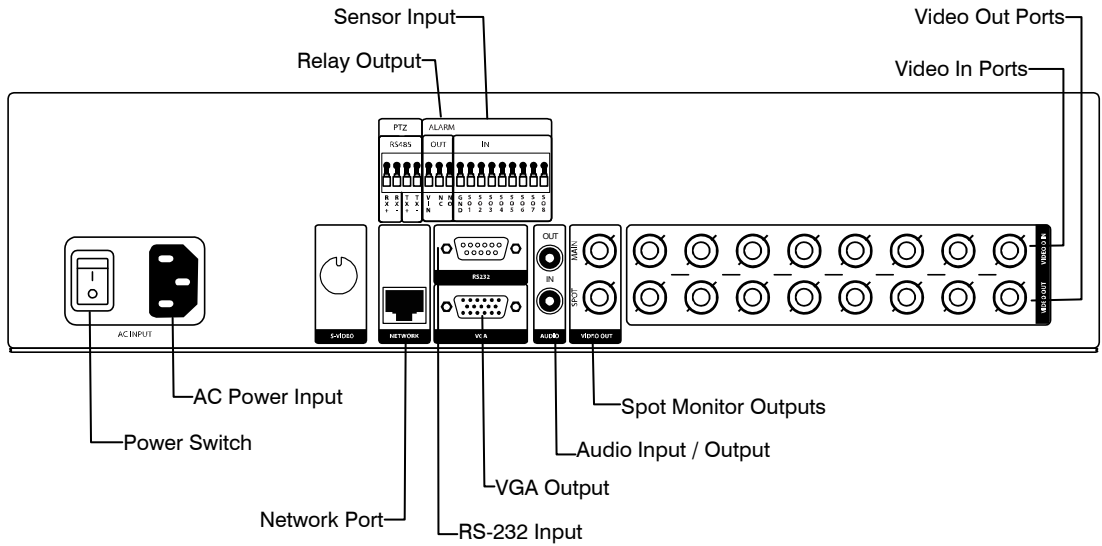

## 16 Channel

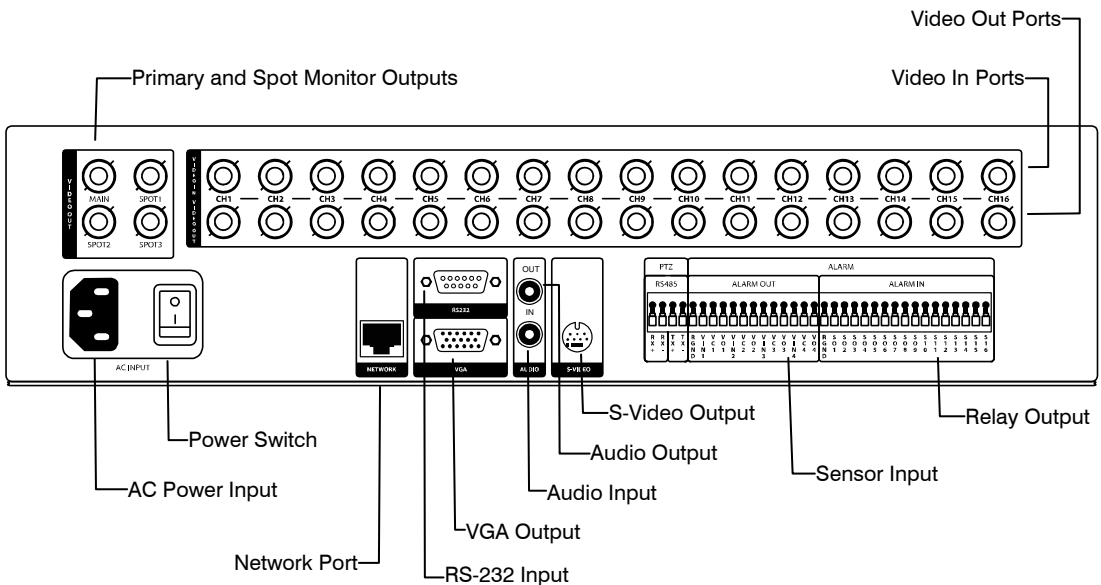

# Remote Control

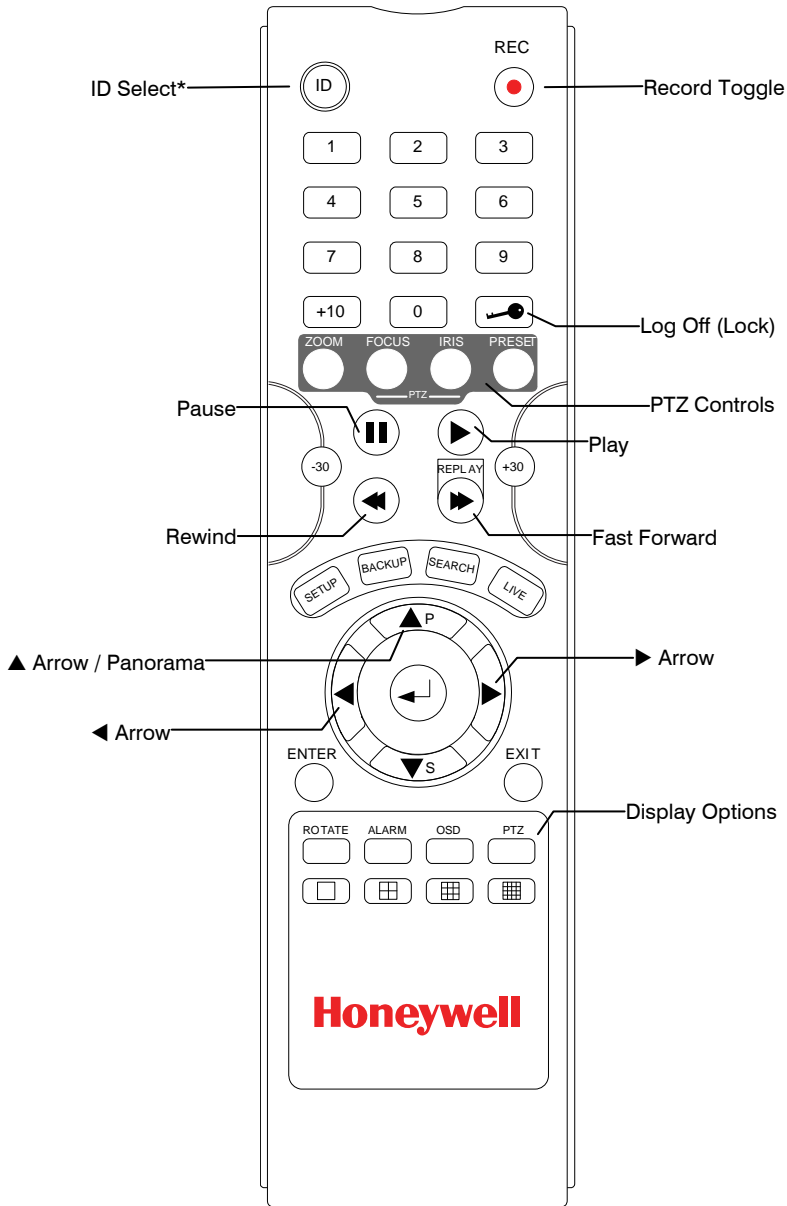

\*The ID Select button allows you to use one remote control for several DVRs.

---

## Connection Guide

---

### Connecting the Monitor

There are three available monitor outputs on the Performance Series DVR.

- Composite Monitor output for CCTV monitor – BNC (Marked MAIN)
- VGA output for VGA monitor – Mini-Sub D15
- S-Video output - Mini-Din 4 (16 Channel only)

### Video Inputs and Looping Outputs

The Performance Series DVR comes with up to 16 BNC video inputs on the rear of its chassis. Each video input has a corresponding looping BNC output beneath it for passing the video signal to another monitoring/recording device.

### Connecting to a Network

Use the RJ45 jack or RS232 port, if using a serial modem, on the rear of the DVR when connecting to a network.



RJ45

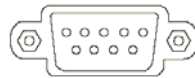

RS232

### Connecting Audio

To record audio on the DVR connect the audio source to the Audio In Port (White) on the back of the chassis.

To listen to live or recorded audio connect the Audio Out Port (Red) to an amplified speaker system.

---

**Note** The DVR audio output is a line level source which requires an amplified speaker system. The audio input can be from an amplified source or directly from a microphone.

---

## Connecting a PTZ Camera

The RS485 connector can be used to control Pan / Tilt / Zoom (PTZ) cameras. See the PTZ camera manufacturer's manual for configuring the RS485 connection.

**Note** Use the RS485 connector for external control systems such as a control keyboard. Connect RX-/TX- and RX+/TX+ of the control system to the TX-/RX- and TX+/RX+ (respectively) of the DVR.

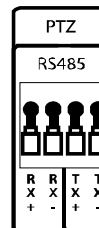

## Connecting to a Sensor Input

To make connections on the Alarm Connector Strip, press and hold the button and insert the wire into the hole above the button. To disconnect the wire press and hold the button below the wire and pull out

### Alarm In

Use external devices to send a signal to the DVR when an event occurs. Mechanical or electrical switches can be wired to the Alarm In and Ground (GND) connectors.

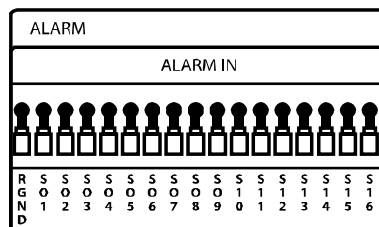

**Note** All connectors marked GND are common. Connect the ground side of the alarm input and/or alarm output to the GND connector.

## Connecting to a Relay Output

To make connections on the Alarm Connector Strip, press and hold the button and insert the wire into the hole above the button. To disconnect the wire press and hold the button below the wire and pull out.

### Alarm Out

The DVR can activate external devices such as buzzers or lights. Connect the external device to the Alarm Out and Ground (GND) connectors. See Sensor Configuration in the manual for more details.

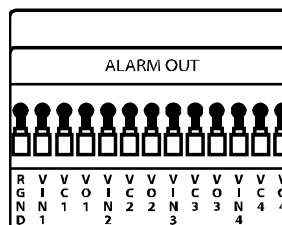



---

## Installing the Rackmount Kit (optional)

---

**Caution** There must be a minimum 1U space between the DVR and any other items in the rack.

---

1. Attach the rackmount brackets with the screws provided on each side of the DVR. Do not remove the plastic edge guards.
  2. Mount the DVR in your rack.
- 

## Turning on the DVR

---

1. Connect the power cable.
  2. Connect camera cables.
  3. Connect a network cable and a monitor cable.
  4. Switch the power switch on the back of the DVR to the ON position and wait until the main screen is displayed on the connected monitor; this process will take approximately two minutes.
- 

**Tip** See the Connection Guide section for more details

---

Installation

NOTES:

# Setup

## Setup Menus

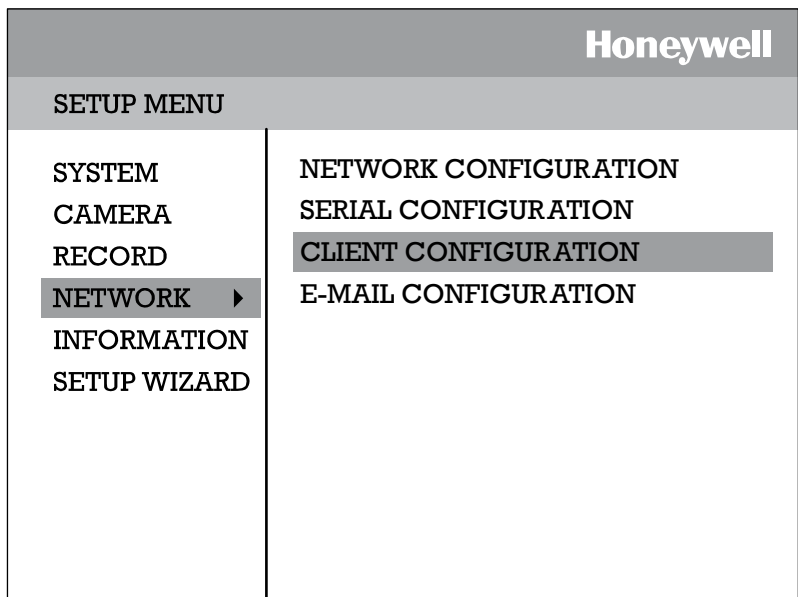

Use the setup menus to configure all of the DVR settings, schedule recording, networking and shutdown.

Press the Setup key on the front of the DVR or remote control to enter the setup menus and log in. See the Quick Start Guide section if entering setup for the first time. Use the ▲ and ▼ keys on the front of the DVR or remote control to navigate individual menus, and use the ◀ and ▶ keys to select a new setup menu.

---

# System

---

## System Configuration

SYSTEM CONFIGURATION	
VIDEO FORMAT	NTSC
LANGUAGE	ENGLISH
DVR ID	0
DATE FORMAT	MM-DD-YYYY
DATE	11/06/2006
TIME	10:44:48
TIME ZONE	GMT-08:00..
USE DST	OFF
NTP	OFF
KEYPAD BEEP	OFF
AUTO LOG OFF	OFF

To enter System Configuration, press the Setup key on the front of the DVR and press ENTER to select System Configuration. Use the arrow buttons on the front panel of the DVR or the remote control to navigate the display. Select Save and press ENTER to update settings.

**Video Format** - NTSC / PAL.

**Language** - ENGLISH / SPANISH [User Selectable].

**System ID** - Required for the operation of multiple units using the supplied IR remote control. Each system must have a unique ID to function properly.

**Date Format** - US (MM-DD-YYYY) / EURO (DD-MM-YYYY) / ASIA (YYYY-MM-DD) – [User Selectable].

**Date** - Press ENTER to select the Date and use the number keys and/or arrow buttons to set the date. Press ENTER again to deselect.

**Time** - Press ENTER to select the Time and use the number keys and/or arrow buttons to set the time. Press ENTER again to deselect.

**Time Zone** - Press ENTER to open the Time Zone window. Use the arrow keys to navigate the list and press ENTER to make selection. Select Exit and press ENTER to close the window.

---

**Note**    The date and time must be set manually; changing the time zone will not automatically change the Time/Date display.

---

## System Configuration Continued

**Use DST** – After completing the Time Zone setup, highlight USE DST and press ENTER to turn Daylight Saving Time ON / OFF.

**NTP** – Highlight NTP (Network Time Protocol) and press ENTER to SYNC the DVR with the Network Time.

**Keypad Beep** - ON / OFF [Enables / Disables Audible keypad touch confirmation].

**Auto Log Off** – OFF or 1-10 Minutes [This feature will close the Configuration Menu after XX minutes of inactivity. This is a security feature.]

## Setup Wizard

The Setup Wizard allows you to define global recording settings for an easy and custom recording schedule on the DVR.

EXPRESS RECORDING CONFIGURATION	
GLOBAL RESOLUTION	352X240
MOTION/CONTINUOUS	CONTINUOUS
AVERAGE DAYS TO RECORD	8.1 DAYS
AVERAGE IPS	1 IPS
AVERAGE PICTURE QUALITY	LOW

**Global Resolution** – 352 x240 / 704 × 240 / 704 × 480.

**Motion/Continuous** – Motion / Continuous.

**Average Days to Record** – [The estimated days of recording determined by resolution, IPS (Images Per Second), Picture Quality, and available storage size.]

**Average IPS** – 1-8 [Maximum varies with resolution.]

**Average Picture Quality** – Low / Normal / High / Ultra.

## Disk Configuration

### Format

---

Shows installed Hard Disk Drives and the status of other attached storage devices.

DISK CONFIGURATION			FORMAT
TYPE	SIZE	STATUS	FORMAT
HDD1	249GB	REC	FORMAT
CD-RW	-	-	<b>ERASE</b>
HDD2	NONE	EMPTY	FORMAT
HDD3	NONE	EMPTY	FORMAT

---

FORMAT ALL      USB RESET

To format a device use the arrow keys to select the appropriate device and press ENTER. Select **OK** to confirm formatting and press ENTER.

To refresh the list of connected USB devices select **USB Reset** and press ENTER.

---

**Note**      Upon formatting a drive, all video and other data stored on that drive will be permanently erased and cannot be recovered.

---

## Overwrite

---

Sets options for overwriting data when the Hard Disk Drive becomes full.

DISK CONFIGURATION		OVERWRITE
HDD OVERWRITE		ENABLE
DISK-FULL WARNING		ON
REMAIN TIME		30 MIN
USED SPACE		90%
DISK-FULL ALARM		0
DISK-FULL BUZZER		OFF
DISK FULL MESSAGE		OFF

Enable **HDD Overwrite** to allow the DVR to write over previously recorded data, starting with the oldest date, when the HDD is full. If set to Off the DVR will not record any new data once the HDD becomes full. (Default)

Enable **Disk Full Warning** for notification when the HDD becomes full and HDD Overwrite is disabled.

## Check

---

Checks the HDD for errors or failure.

## SMART Check

---

*SMART* = Self Monitoring Analysis & Reporting Technology.  
Enable SMART Check to detect signs of HDD failure.

DISK CONFIGURATION		SMART
ENABLE SMART	ENABLE	
CHECK INTERVAL	1 HOUR	
TEMP. THRESHOLD	60 C	
S.M.A.R.T. WARNING	POPUP	
CHECK NOW		
HDD INFORMATION		

FORMAT    OVERWRITE    CHECK    SMART

SAVE    CANCEL

1. Select SMART Enable and press ENTER to Enable or Disable.
2. Set a check interval between 1 and 24 hours.
3. Define a temperature threshold and select Celsius or Fahrenheit.

---

**Note**    The recommended upper optimum operating temperature for the HDD is between 104F to 122F (40C to 50C).

---

4. Select a warning to be activated when the HDD reaches the defined threshold.
5. Select Save and press ENTER to save settings.

---

**Tip**    Select HDD INFORMATION and press ENTER to view the current HDD, DVD, and USB drive information.

---



## User Configuration

Use the User Configuration to Add or Delete users.

### Server

Use the Server menu to manage users that access the DVR locally.

USER CONFIGURATION				SERVER
AUTHORIZATION ADMIN				
1	admin	ADD/CHANGE	DEL	
2	NONE	ADD/CHANGE	DEL	
3	NONE	ADD/CHANGE	DEL	
4	NONE	ADD/CHANGE	DEL	
5	NONE	ADD/CHANGE	DEL	
6	NONE	ADD/CHANGE	DEL	
<b>SERVER</b>		<b>CLIENT</b>		
SAVE		CANCEL		

To add a new user:

1. Select the authorization level to display the names of the users in that level (Admin, SuperUser, User) by selecting the user type at the top of the screen and pressing ENTER to cycle to the next level.

User	SuperUser	Admin
<i>Live View</i>	<i>User Privileges</i>	<i>SuperUser Privileges</i>
<i>Replay</i>	<i>Search</i>	<i>Setup</i>
<i>PTZ</i>	<i>Backup</i>	

2. Select ADD/CHANGE on an unused row and press ENTER.
3. Use the on-screen keyboard to input the user name.
4. Select OK.
5. Set the user password using the onscreen keypad or the key buttons on the front panel or remote control. Repeat the password to confirm.
6. Repeat the above steps to set up more users at appropriate authorization levels.
7. Select Save and press ENTER to save settings.

## Client

---

Use the Client menu to manage users that access the DVR remotely. Remote users must be defined on this page. Only the users defined here can access the DVR remotely. Add up to 18 users in addition to the two Admin users.

USER CONFIGURATION			CLIENT
	LOGIN ID	PASSWORD	PERMISSIONS
ADMIN1	admin1	****	▶
ADMIN2	admin2	****	▶
USER1	user1	****	▶
USER2	user2	****	▶
USER3	user3	****	▶
USER4	user4	****	▶
USER5	user5	****	▶
USER6	user6	****	▶
USER7	user7	****	▶
USER8	user8	****	▶
PAGE1	PAGE2		

To add a new user:

1. Select a Login ID and press ENTER to change the Login ID.
2. Use the on-screen keyboard to input the user name.
3. Set the user password using the onscreen keypad or the number buttons on the front panel or remote control. Repeat the password to confirm.
4. Set the user permissions.  
Playback - ON/OFF                      Live View – 1~16, ALL, OFF  
Backup - ON/OFF                        PTZ Control – 1~16, ALL, OFF  
Health Check - ON/OFF
5. Repeat the above steps to set up additional users.
6. Select Save and press ENTER to save settings.

## Configuration

Import and Export current settings. See details in the Save Settings Section.

## Shutdown

Use Shutdown to safely shutdown the system.

1. Select System > Shutdown.
2. Select OK to confirm and press ENTER to safely shutdown the system.
3. Turn the power off when shutdown is complete using the toggle switch on the back of the DVR.

---

**Note** Improper shut down of the system can cause data loss and system corruption.

---

## Camera

---

### Camera Configuration

**CH** –Camera Channels

**NAME** – Use the on-screen keyboard to enter a camera name [user defined]

**ENABLE** – On / Off

**HIDDEN** (from Main Monitor) – Off / On

**ADJUST** –Detailed camera display settings

CAMERA CONFIGURATION				
CH▼	NAME	ENABLE	HIDDEN	ADJUST
1	C1	ON	OFF	▶
2	C2	ON	OFF	▶
3	C3	ON	OFF	▶
4	C4	ON	OFF	▶
5	C5	ON	OFF	▶
6	C6	ON	OFF	▶
7	C7	ON	OFF	▶
8	C8	ON	OFF	▶
9CH-16CH				
		SAVE	CANCEL	

## Color Setup (Adjust)

**COLOR SETUP - LIVE**

CAMERA	1
SCREEN MODE	LIVE
BRIGHT	0
CONTRAST	0
SATURATION	0
HUE	0
POSITION	▲▼◀▶
APPLY ALL	

**Camera** - 1 ~ 16 [camera to apply color settings to]

**Screen Mode** - Live / Record

**Bright** - -25 ~ 25

**Contrast** - -25 ~ 25

**Saturation** - -25 ~ 25

**Hue** - -25 ~ 25

**Position** - ▲ ▼ ◀ ▶ [position of video from this camera on the screen]

**Apply All** - Apply current color settings to all cameras

## PTZ Configuration

**PTZ CONFIGURATION**

CH▼	PORT	ID	PROTOCOL
1	4800-8N1	1	NONE
2	4800-8N1	2	NONE
3	4800-8N1	3	NONE
4	4800-8N1	4	NONE
5	4800-8N1	5	NONE
6	4800-8N1	6	NONE
7	4800-8N1	7	NONE
8	4800-8N1	8	NONE

9CH-16CH

**CH** - Camera Channels

**PORT** -Sets the port information for the connected camera. [Consult the documentation provided by the camera manufacturer to obtain this information.]

**ID** - Sets the PTZ ID from 1-255

**PROTOCOL** -Select a PTZ protocol

## Spot / Sequence Configuration

SPOT/SEQUENCE CONFIGURATION				
SPOT _____				
NO.	SEQUENCE	CAMERA	INTERVAL	CURRENT
1	OFF	ALL	2 SEC	CAM 1
2	OFF	ALL	2 SEC	CAM 1
3	OFF	ALL	2 SEC	CAM 1
SEQUENCE _____				
PAGE DWELL TIME		2 SEC		
CAMERA DWELL TIME		2 SEC		
CUSTOM SELECT		ALL		
<input type="button" value="SAVE"/>		<input type="button" value="CANCEL"/>		

### *Spot*

**Sequence** - On/Off [Sequence through selected cameras].

**Camera** - Select cameras to include in sequence.

**Interval** - 1 ~ 60 seconds [Set the sequence interval time].

**Current** - Camera 1 ~ Camera 16 [Set current camera].

### *Sequence*

**Page Dwell Time** - 0 ~ 100 seconds [Set the sequence interval time for full page].

**Camera Dwell Time** - 0 ~ 100 seconds [Set the sequence interval time for individual cameras].

**Custom Select** - 1 ~ 16 / All [Select cameras to display in on Spot Monitor].

## Monitor Configuration

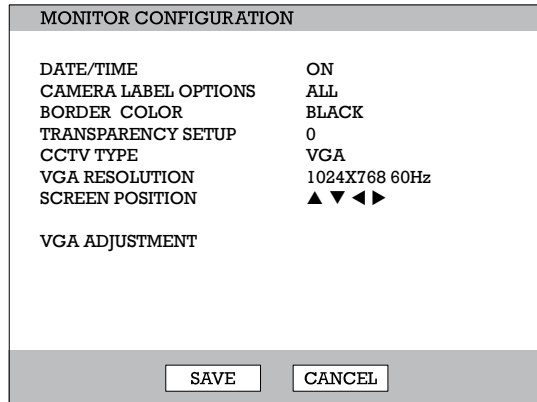

**Date/Time** – On / Off [On-screen Date/Time display].

**Camera Label Options** – All / Name / Number / Off.

**Border Color** - Black / White / Grey [Set the border color of the grid for the main channel display].

**Transparency Setup** – 0 ~ 20 [Set the transparency of the setup windows].

**CCTV Type** – VGA / Analog [Set the Display Monitor type].

**VGA Resolution** – Set monitor resolution.

**Screen Position** – Adjust the screen position of the main channel display.

**VGA Adjustment** – Set brightness, contrast, saturation and position.

## Record

### Record Configuration

Use Record Configuration to configure the recording schedule and frame capture rate. In Schedule Setup, users can define the recording schedules:

- Day
- Night
- Weekend

### Frame

RECORD CONFIGURATION					FRAME	
DAY	SIZE	R-MODE	C-FPS	M-FPS	QUALITY	POST-A
1	704X240	C+M	1	4	HIGH	5 SEC
2	704X240	C+M	1	4	HIGH	5 SEC
3	704X240	C+M	1	4	HIGH	5 SEC
4	704X240	C+M	1	4	HIGH	5 SEC
5	704X240	C+M	1	4	HIGH	5 SEC
6	704X240	C+M	1	4	HIGH	5 SEC
7	704X240	C+M	1	4	HIGH	5 SEC
8	704X240	C+M	1	4	HIGH	5 SEC

INFORMATION

9CH-16CH (Used FPS) C: 128/128 M: 64/128  
 C: CONTINUOUS, M: MOTION/EVENT

FRAME SCHEDULE AUDIO INSTANT

SAVE CANCEL

Configure the FPS for each schedule – Day / Night / Weekend.

**Size** – 352 × 240 / 704 × 240 / 704 × 480. [Resolution]

**R-Mode** - C / M / C+M / N/A. [Recording Mode](Default is C+M)

C: Continuous

M: Motion / Event

**C-FPS** – 1-30 [Continuous Recording FPS]

**M-FPS** – 1-30 [Motion Recording FPS]

**Quality** – Low / Normal / High / Ultra

**Post-A** – 5-100 seconds [Post Alarm Recording]

## Schedule

---

RECORD CONFIGURATION		SCHEDULE
NIGHT	FROM 00:00:00	TO 00:00:00
WEEKEND	N/A	N/A

INFORMATION \_\_\_\_\_  
BY DEFAULT DAYTIME IS 24/7. TO SET UP A   
DIFFERENT SCHEDULE FOR NIGHTTIME OR WEEKENDS  
ADJUST THE NIGHTTIME AND WEEKEND OPTIONS  
ABOVE.

FRAME SCHEDULE AUDIO INSTANT  
SAVE CANCEL

**Night** – Set nighttime (ex. If 18:00 to 6:00 is defined as nighttime, 6:00 to 18:00 is defined as daytime).

**Weekend** –Define weekend.

## Audio

---

RECORD CONFIGURATION		AUDIO
DAY	DISABLE	
NIGHT	DISABLE	
WEEKEND	DISABLE	
LIVE	DISABLE	
SEARCH	DISABLE	
VOLUME	7	

FRAME SCHEDULE AUDIO INSTANT  
SAVE CANCEL

1. Specify volume level and audio settings for recording according to preset schedules and live or search mode.
2. Select Enable/Disable for each schedule mode.
3. Select Enable/Disable for live/search mode.
4. Set the audio Volume.



## Instant Recording

---

Configure the recording settings for Instant Recording to use when it is activated.

RECORD CONFIGURATION		INSTANT RECORDING	
FPS	4		
QUALITY	NORMAL		
SIZE	352X240		

FRAME	SCHEDULE	AUDIO	INSTANT
SAVE		CANCEL	

**FPS** – Set the FPS (recording rate per camera).

**Quality** –Set the picture quality (affects file size).

**Size** – Set the resolution of the video image.

## Using Instant Recording

To activate Instant Recording on the DVR:

1. Press the button with the red dot on the front panel of the DVR or remote control.
2. Select OK to Force Continuous Recording.
3. Press ENTER. The screen will display the Instant Record message.

To cancel Instant Recording on the DVR:

1. Press the button with the red dot on the front panel of the DVR or remote control.
2. Select OK Resume Scheduled Recording.
3. Press ENTER.

## Motion/Event Configuration

Motion / Event Configuration has four sections; Input, Sensor, Action, and Alarm Monitor. When an event comes in (Input) the DVR records the image according to its settings (Camera Configuration) and triggers an alarm (Action).

### Input

MOTION/EVENT CONFIGURATION						INPUT
CH▼	MOTION	SENS	AREA	SENSOR	V-LOSS	TEXT-IN
1	ON	NORMAL ▶		OFF	OFF	ON
2	ON	NORMAL ▶		OFF	OFF	ON
3	ON	NORMAL ▶		OFF	OFF	ON
4	ON	NORMAL ▶		OFF	OFF	ON
5	ON	NORMAL ▶		OFF	OFF	ON
6	ON	NORMAL ▶		OFF	OFF	ON
7	ON	NORMAL ▶		OFF	OFF	ON
8	ON	NORMAL ▶		OFF	OFF	ON
9CH-16CH						
<input type="button" value="INPUT"/>		<input type="button" value="SENSOR"/>		<input type="button" value="ACTION"/>		<input type="button" value="ALARM MONITOR"/>
<input type="button" value="SAVE"/>				<input type="button" value="CANCEL"/>		

**CH** – ▲ Channels 1-8 / ▼ Channels 9-16

**MOTION** – On/Off [Specify whether to use motion input or not.]

**SENS (Sensitivity)** – Low / Normal / High / Highest

**AREA** – Define the motion detection area.

**SENSOR** – Associate a sensor with the camera channel.

**V-LOSS (Video Loss)** – Select a channel to report video loss on.

**TEXT-IN** – On / Off

## Setting Up Motion Detection Recording

To record data only when motion is detected:

MOTION/EVENT CONFIGURATION						INPUT
CH▼	MOTION	SENS	AREA	SENSOR	V-LOSS	TEXT-IN
1	ON	NORMAL ▶		OFF	OFF	ON
2	ON	NORMAL ▶		OFF	OFF	ON
3	ON	NORMAL ▶		OFF	OFF	ON
4	ON	NORMAL ▶		OFF	OFF	ON
5	ON	NORMAL ▶		OFF	OFF	ON
6	ON	NORMAL ▶		OFF	OFF	ON
7	ON	NORMAL ▶		OFF	OFF	ON
8	ON	NORMAL ▶		OFF	OFF	ON
9CH-16CH						
INPUT		SENSOR		ACTION		ALARM MONITOR
SAVE				CANCEL		

1. Press Setup on the front of the DVR or remote control.
2. Select Record > Motion/Event Configuration and set MOTION to On.
3. Set SENS level. [Normal / High / Highest / Low].
4. Select AREA and press ENTER to set a motion area (global setting; each channel can be configured individually).
5. Use the arrow buttons and the numeric buttons 1, 2 and 3 to navigate the motion area grid. (Selected motion areas are highlighted green on the grid.)
  - 1 = Set Mode    2 = Clear Mode    3 = Move Mode
  - a. Press 3 on the front of the DVR or remote control.
  - b. Use the arrow buttons to move the cursor to the desired location on the screen.
  - c. Press 1 on the front of the DVR or remote control.
  - d. Use the arrow buttons to highlight the desired motion detection area.
  - e. Repeat the steps above to create additional motion detection areas.
6. When finished selecting motion areas press ENTER on the front of the DVR or remote control to save changes.
7. Repeat as necessary for each channel.
8. When motion area setup is complete select SAVE to save settings and exit setup.

## Sensor

MOTION/EVENT CONFIGURATION		SENSOR	
NO. ▼	TYPE	NO.	SIGNAL
1	N/O	1	ON
2	N/O	2	ON
3	N/O	3	ON
4	N/O	4	ON
5	N/O		
6	N/O		
7	N/O		
8	N/O	SET	CLEAR
9CH-16CH			

### *Sensor Setup*

1. Use the arrow buttons to select Sensor 1 and press ENTER to change to N/O (Normally Open) or N/C (Normally Closed).
2. Repeat for all sensors.
3. Select SAVE and press ENTER to save settings and exit Sensor Setup.

### *Relay Setup*

1. Use the arrow buttons to select Relay 1 and press ENTER to turn OFF or ON.
2. Repeat for all relays.
3. Select SAVE and press ENTER to save settings exit Sensor Setup.

## Action

MOTION/EVENT CONFIGURATION					ACTION
CH▼	ALARM	DELAY	DURATION	PRESET	
1	OFF	OFF	OFF	OFF	
2	OFF	OFF	OFF	OFF	
3	OFF	OFF	OFF	OFF	
4	OFF	OFF	OFF	OFF	
5	OFF	OFF	OFF	OFF	
6	OFF	OFF	OFF	OFF	
7	OFF	OFF	OFF	OFF	
8	OFF	OFF	OFF	OFF	
9CH-16CH					
EVENT POPUP		OFF			
<input type="button" value="INPUT"/>		<input type="button" value="SENSOR"/>		<input type="button" value="ACTION"/>	
		<input type="button" value="ALARM MONITOR"/>			
			<input type="button" value="SAVE"/>		<input type="button" value="CANCEL"/>

**CH** – ▲ Channels 1~8 / ▼ Channels 9~16

**Alarm** – OFF / 1~4 [Associate an alarm relay with a channel].

**Delay** – 0~100 Seconds [Delay time before relay activates].

**Duration** – 0~100 Seconds [Time that the relay is active].

**Preset** – 0~100 [Enable PTZ camera to move to a preset position when an event occurs. See PTZ Control for more information.]

**Event Popup** – ON / OFF [Displays channel associated with event].

## Alarm Monitor

Send event information to a remote client using the Alarm Monitor software.

MOTION/EVENT CONFIGURATION			ALARM MONITOR
SEND TO ALARM MONITOR			ON
NO.	IP ADDRESS	PORT	
1	0.0.0.0	2001	
2	0.0.0.0	2001	
3	0.0.0.0	2001	
4	0.0.0.0	2001	
5	0.0.0.0	2001	
<input type="button" value="INPUT"/>		<input type="button" value="ALARM MONITOR"/>	
		<input type="button" value="SENSOR"/>	
		<input type="button" value="ACTION"/>	
			<input type="button" value="SAVE"/>
			<input type="button" value="CANCEL"/>

1. Select Enable and press ENTER to select ON.
2. Enter the IP Address of the remote client.
3. Enter the Port Number.

---

# Network

---

## Network Configuration

Configure network settings.

NETWORK CONFIGURATION	
NETWORK	
<input checked="" type="checkbox"/> DHCP	HOST NAME <b>dvr</b>
IP ADDRESS	000.000.000.000
SUBNET MASK	000.000.000.000
GATEWAY	000.000.000.000
DNS	000.000.000.000
DDNS	
DDNS SERVER	<b>HWddns.com</b>
ID	<b>user</b>
PASSWORD	<b>****</b>
HOST NAME	<b>host</b>
ROUTER IP	<b>OFF</b>
STATUS	<b>CHECK</b> UNCHECKED

- DHCP**     *Select* – System gets IP address from DHCP server.  
*Clear* – User must manually define a static IP address. Contact the network administrator for this information.
  
- Host Name** – The DVR name.
  
- IP Address** – DHCP or Static. Contact your network administrator for this information.
  
- DDNS Server** – The current DDNS server.
  
- ID** – Username for the DDNS server account.
  
- Password** – Password for the DDNS server account.
  
- Host Name** – Hostname for the DDNS server account.

## Serial Configuration

Configure connected serial devices.

SERIAL CONFIGURATION	
<b>RS232</b>	
TYPE	EXTERNAL CONTROLLER
MODEL	NONE
PORT	9600-8N1
<b>RS485</b>	
TYPE	TEXT-IN
TARGET	NONE
PORT	9600-8N1
<input type="button" value="SAVE"/> <input type="button" value="CANCEL"/>	

**Type** – None / External Controller / Text-In

*External Controller*

**Model** – Select appropriate model from the supported list.

**Port** – [Baud Rate / Data Bit / Parity / Stop Bit]

*Text-In*

**Target** – [User Defined]

**Port** – [Baud Rate / Data Bit / Parity / Stop Bit]

Supported External Controller Models:

- Honeywell HJZTP
- Hitron HID2404CEN
- Hunt HKB-300
- 7323 DKB-06
- 05-255
- WC-2500/3000J
- WTX-1500/2000

## Client Configuration

Configure general remote access.

CLIENT CONFIGURATION	
REMOTE PORT	2000
WEB PORT	80
REMOTE CONFIG	ENABLE
MAX TRANSFER SPEED	100 Mbps

**Remote Port** – Use this port number when configuring remote access software. The default port is 2000 but can be changed.

**Web Port** – Used for remote connections using a web browser. This port should be open on the router. Default web port is 80.

**Remote Config** – Enable to allow an administrator to change configurations using remote access software.

**Max Transfer Speed** – Set network bandwidth. If the network is low speed, set this value as the network (aka. Bandwidth Throttling).



## E-mail Configuration

The DVR can send an email notification to up to six defined e-mail addresses when an event happens.

**E-MAIL SERVER SETUP**

MAIL SERVER	SMTP SERVER
USER NAME	USERNAME
USER E-MAIL	email@ddnsdvr.com
SERVER	ddnsdvr.com
PORT	25
ID	USERID
PASSWORD	****

**E-mail Server** – DVR/SMTP [Configure the DVR to use selected e-mail server.]

**Schedule** – On/Off [Enable to send e-mail notifications only for events that occur within a specified range of time.]

**Time** – Define the time of day to send e-mail notification of events (example: 19:00-6:00 – after business hours).

**Option** – Define the type of event that will trigger an e-mail notification.

**Pic** – Enable to send a picture of the event.

**E-mail Address** – Enter the e-mail address.

**E-MAIL CONFIGURATION**

**E-MAIL SERVER**

SCHEDULE      ON  
 TIME            19:00:00 ~ 08:00:00

NO.	OPTION	PIC.	E-MAIL ADDRESS
1	SET	OFF	email@ddnsdvr.com
2	SET	OFF	email@ddnsdvr.com
3	SET	OFF	email@ddnsdvr.com
4	SET	OFF	email@ddnsdvr.com
5	SET	OFF	email@ddnsdvr.com
6	SET	OFF	email@ddnsdvr.com

**E-MAIL 5**

- MOTION
- SENSOR
- VIDEO LOSS
- TEXT-IN
- POWER
- SETUP
- LOGIN FAIL
- DISK FULL
- SMART

---

# Information

---

## System Log View

Displays system log information.

SYSTEM LOG VIEW		
NO.	BEGIN DATE	SYSTEM LOG
0317	07/17 12:00:21	Login Success(ID :root)
0316	07/17 12:00:11	Logout
0315	07/17 10:33:14	Login Success(ID :root)
0314	07/17 10:32:45	Logout
0313	07/17 10:22:41	Login Success(ID :root)
0312	07/17 10:21:12	Logout
0311	07/17 10:11:07	Login Success(ID :root)
0310	07/17 10:11:01	Logout
0309	07/17 10:01:00	Login Success(ID :root)

PREV NEXT                      USB-EXPORT

## Status View

Displays status screens for:

STATUS VIEW	
STATUS DISK	
CONTENT	STATUS
RECORDING START	07/06/07 12:55:47
RECORDING END	07/11/06 13:05:00
DISK CAPACITY	249GB
USED SPACE	533MB (0%)
AVAILABLE SPACE	249GB (100%)
HDD OVERWRITE	ENABLE

*Disk*

STATUS VIEW			
STATUS RECORD			
CAM	FPS	RESOLUTION	QUALITY
1	10/15	352X240	NORMAL
2	10/15	352X240	NORMAL
3	4/4	352X240	NORMAL
4	4/2	352X240	NORMAL
5	4/0	352X240	NORMAL
6	4/0	352X240	NORMAL
7	4/0	352X240	NORMAL
8	4/0	352X240	NORMAL

*Record*

STATUS VIEW	
STATUS AUDIO	
NO.	RECORD
1	OFF

*Audio*

## Version View

Displays system information and software version information for the DVR.

VERSION VIEW	
VIDEO FORMAT	NTSC
DVR PROGRAM	2.5.5.H15
PTZ MODULE	2.0
DRIVER MODULE	7.01-16-N
FIRMWARE	6.02.21
MAC ADDRESS	00:19:19:01:04:8D
VIDEO MUX	51005.0
VIDEO CODEC	60115.0
VIDEO I/O	40618.0

# Operation

---

## Search

---

### Searching Recorded Data

Search recorded video on the DVR to find a specific time or event.

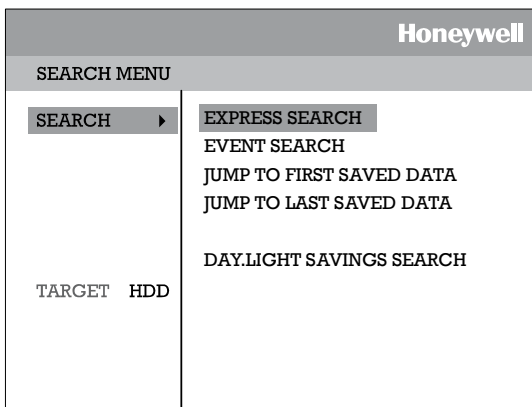

1. Press the Search key on the front of the DVR or the remote control to enter Search Mode.
2. Select Target media (HDD, DVD-RW, USB)
3. Select the desired search method.
4. Select Exit to return to Live Mode.

## Search Methods

### Express Search

---

Users can select a specific date and time of recorded data to search.

EXPRESS SEARCH	
NO.	DATE
13	2007 / 7 / 17
12	2007 / 7 / 16
11	2007 / 7 / 15
10	2007 / 7 / 14
9	2007 / 7 / 13
8	2007 / 7 / 12
7	2007 / 7 / 11
6	2007 / 7 / 10
5	2007 / 7 / 09
4	2007 / 7 / 08

PREV NEXT

1. Select Express Search.
2. Select a Date from the list and press ENTER.
3. Define time by using the arrow buttons to move the bar across the grid (Highlighted time blocks represent recorded data). Press ENTER to go from the desired hour to the minutes selection.
4. Select Play.
5. Use the play controls on the front of the DVR or remote control to search video.

### Event Search

---

Define a search based on event recorded data.

1. Select Event Search.
2. Define the date and time to search.
3. Define the type of event occurrences to include in search.
4. Define cameras to include in search or select All cameras.

### Daylight Savings Search

---

Daylight Savings Search is used to find recorded data after switching the time at the end of Daylight Savings Period. The System will record data with the same time stamp for two hours when they are repeated. If any overlapped time data exists the system will display the times on this page.

## Go To First

---

View the earliest recorded data

## Go To Last

---

View the most recent recorded data

## Go To Jump

---

View video from a 24 hour period

---

**Note** When DVD-RW is selected as the target media, only Express Search, Go To First Recorded Data and Go To Last Recorded Data Search options are available.

---

## Search Details

In Search Mode users can access the Popup Menu for extended options; see the Popup Menu section.

## Search Popup Menu

Use to access display options in Search Mode.

1. Press ENTER to highlight a channel box.
2. Use the arrow keys to select the desired channel.
3. Press ENTER again to open the Popup Menu.

**Time Selection** – Change the Date/Time to search.

**Live Cam Change** – Change the channel box to display the selected live channel.

**Play Cam Change** – Change the channel box to display the selected playback channel.

**Save JPEG** – (disabled)

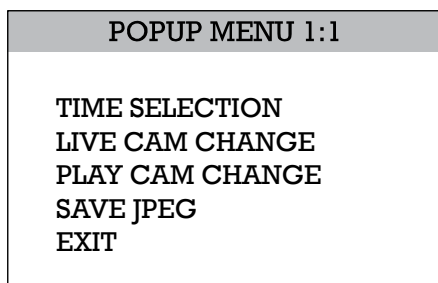

---

# Monitoring

---

## Select Channel

- Use the number keys on the front of the DVR or remote control to select specific channels for full screen display.  
(**ex.** Press 1 to display channel 1)
- Press the LIVE key to change the display mode. Display switches in the following order when the LIVE key is pressed successively.

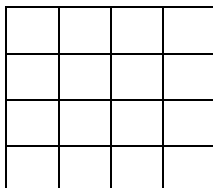
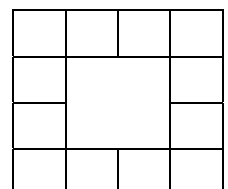
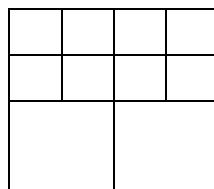
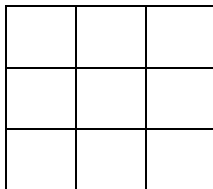
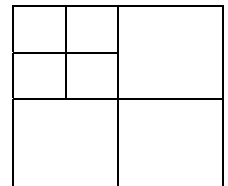
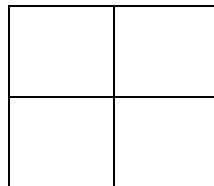
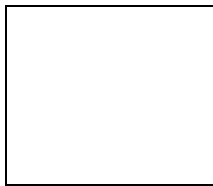

- Press the ROTATE key to rotate through to the remaining channels within the display mode or rotate the display configuration.

## Live Popup Menu

Use to access display options in Live Mode.

1. Press ENTER to highlight a channel box.
2. Use the arrow keys to select the desired channel.
3. Press ENTER again to open the Popup Menu.

**Hide Live View** – On/Off [Hide live display of the selected camera]

**Record Change** – Change the record settings for that channel including FPS, quality, and resolution.

**Sequence** – Start/Cancel camera sequence.

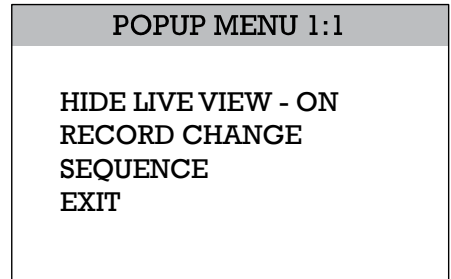



---

## Backup (Export)

---

### Manual Export

Back up recorded data on a CD-RW, DVD-RW or connected USB device.

EXPORT		MANUAL EXPORT
TYPE	MANUAL EXPORT	
TARGET	DVD-RW	
FROM	07/05/2007 12:55:47	
TO	07/17/2007 13:30:03	
CHANNEL	All	
RECORDING START TIME		
2007/07/05 10:00:00		
RECORDING END TIME		
2007/07/17 09:59:59		
REQUIRED SPACE	0.00MB	
FREE SPACE	NONE	
ESTIMATE	WRITE	HELP
<input type="button" value="EXIT"/>		

1. Press the Backup key on the front panel or remote control and log in.
2. Select TARGET media.
3. Set FROM and TO date and time.
4. Select CHANNELS to include in backup.
5. Insert media.
6. Select ESTIMATE to display estimated data size and free space available.
7. Select WRITE to start backup.

---

**Warning** Do not shutdown the system during the backup process.

---

## Play Back Backup Image

---

Play recorded video on a PC using the proprietary media player included with every backup file.

1. Insert CD, DVD or connect external USB device to the PC.
2. Navigate to the files on the CD, DVD, or USB drive.
3. Double-click the DvrPlayer application.
4. Click the Open Video File icon and select the file to view from the desired date folder.

---

## S/W Upgrade

---

If you are running a Performance Series OS version 2.5.1.X or later, obtain the latest software release and save the file to a CD, DVD or USB Device. Please check the product web site at [www.honeywellvideo.com](http://www.honeywellvideo.com) or contact Technical Support for the latest software. See back cover for contact information.

1. Insert a CD/DVD or USB Drive containing the update files.
2. Select System > Shutdown and select Restart.
3. Select OK to confirm Restart. The DVR will restart and automatically find the update files.
4. Select Start when the upgrade window appears.
5. Remove the upgrade media and select OK when the Upgrade Success window appears.
6. Restart the DVR.

## Save Settings

Use the System Configuration menu to export and import saved or factory default system settings.

CONFIGURATION				
PROFILE	LOAD	SAVE	SAVE DATE	DEL
DEFAULT	LOAD	SAVE	NONE	DEL
NONE	LOAD	SAVE	NONE	DEL
NONE	LOAD	SAVE	NONE	DEL
NONE	LOAD	SAVE	NONE	DEL
NONE	LOAD	SAVE	NONE	DEL
NONE	LOAD	SAVE	NONE	DEL
NONE	LOAD	SAVE	NONE	DEL
<hr/>				
EXPORT	IMPORT			
<input type="button" value="EXIT"/>				

## Save Settings

1. Press the Setup key on the front of the DVR or remote control to log in.
2. Select System > Configuration and log in.
3. Select an empty Profile and define a name for the settings configuration. To save settings to a USB device, select Export.
4. Select Save and confirm to continue the export process.

## Import Settings

1. Press the Setup key on the front of the DVR or remote control.
2. Select System > Configuration and log in.
3. Select a previously saved Profile and select Load. To import a profile saved on a USB device, select Import.
4. Select the types of settings to import (CAMERA – RECORD – SYSTEM – NETWORK).
5. Select OK and press ENTER on the front of the DVR to complete the import process.

---

## PTZ Camera Control

---

To control a PTZ camera:

1. Press the PTZ key to enter PTZ Mode.
2. Press SETUP to open the PTZ SETUP screen.

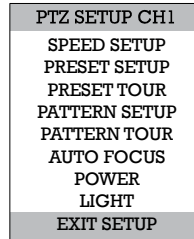

**Speed Setup** – 1-8 [Set the speed that PTZ cameras move.]

**Preset Setup** – Move/Set [Create preset PTZ camera positions.]

**Preset Tour** – [Create a tour of preset PTZ camera positions.]

**Pattern Setup** - [Create a custom PTZ Pattern]

**Pattern Tour** - [Create a Pattern (mimic) tour]

**Auto Focus** – [Modify Auto Focus settings]

**Power** – ON/OFF

**Light** – ON/OFF

## Create PTZ Preset Position

1. Set up a PTZ camera in Camera > PTZ Configuration.
2. Press the Exit key to exit Setup.
3. Press the PTZ key to enter PTZ Mode.
4. Select a PTZ enabled camera.
5. Press the Setup button to display the PTZ setup menu.
6. Select Preset Setup.
7. Select MOVE to move the camera to the preset position.
8. Select a PTZ Preset ID number and select OK to save.

NOTES:

# Remote Software

---

## Set Up a Remote Connection

---

The administrator and up to eighteen additional users (four simultaneously) can access the DVR remotely using software installed on a personal computer.

## Configuring the DVR

1. Press the Setup key on the front of the DVR or remote control to log in.
2. Select Network > Client Configuration (See the Client Configuration section of this manual for more details).
3. Change port settings or write down current port settings.
4. Select Save to save current settings.
5. Select Network Configuration (see the Network Configuration section of this manual for more details).
6. Enable or clear DHCP depending on the network (Ask the network administrator for assistance).
7. If DHCP is cleared - define the IP address and additional network information.
8. If DHCP is enabled - write down the IP address supplied by the DVR system.

---

**Note** If the DVR does not display the IP Address after setting DHCP to ON, Select Save to change the network and open Network Configuration again.

---

9. Select Save to save current settings.

## Configuring the DVR Continued

1. Go to System > User Configuration> Client to add remote users.

---

**Note** Only users defined in System > User Configuration > Client will be able to access the system remotely.

---

2. Select Save to save current settings.

## Configuring a Remote PC

1. Install the Remote Software on a PC using the disk provided with your DVR.
2. Open the Remote Software. The Local Setup window will open automatically.
3. Click New.
4. Select HRDP Performance Series as the Site Type.
5. Enter a name for the system in the Site Name box.
6. Enter the IP address of the DVR - found in Network > Network Configuration on the DVR.
7. Enter the Port number found in Network Client Configuration on the DVR system (default is 4000).
8. Click OK.
9. Enter the user name and password of an authorized remote user as defined in System > User Configuration > Client on the DVR.

---

**Note** User Name and Password are both case sensitive.

---

10. Click Connect.

## Default Remote Software Log In Information

---

The default administrative log in information for the remote software:

**User Name:** admin1

**Password:** <none>

## Access Remote Connection

---

1. Open the Remote Software.
2. Click on the icon of the server as defined previously.
3. Enter the user name and password of an authorized remote user as defined in the System > User Configuration > Client menu on the DVR.

---

**Note** User Name and Password are both case sensitive.

---

4. Click Connect.
- 

## Using the Remote Software

---

### Setting the Time and Date

The Remote Software uses the system time of the PC. If the system time is not correct, follow the steps below to change it.

1. Exit to Windows by clicking the Exit button on the Live View screen and selecting Restart in Windows Mode.
2. Open Windows Explorer. Do this by right-clicking the My Computer Icon (located on the top left hand corner of the Desktop) and select Explore.
3. Click Control Panel to open it. If you do not see Control Panel listed, click My Computer to expand the folder tree.
4. Double-click Date and Time inside Control Panel.
5. Adjust the Date and Time.
6. When finished, close all open windows and restart the PC. Do this by clicking Start (located on the lower left hand side of the Desktop) and selecting Shut Down.



## Live View Screen

Each time the software is restarted, the program defaults to the Live View screen. The following diagram outlines the buttons and features used on the Live View screen. It is important to be familiar with these options as this is the screen displayed the majority of the time.

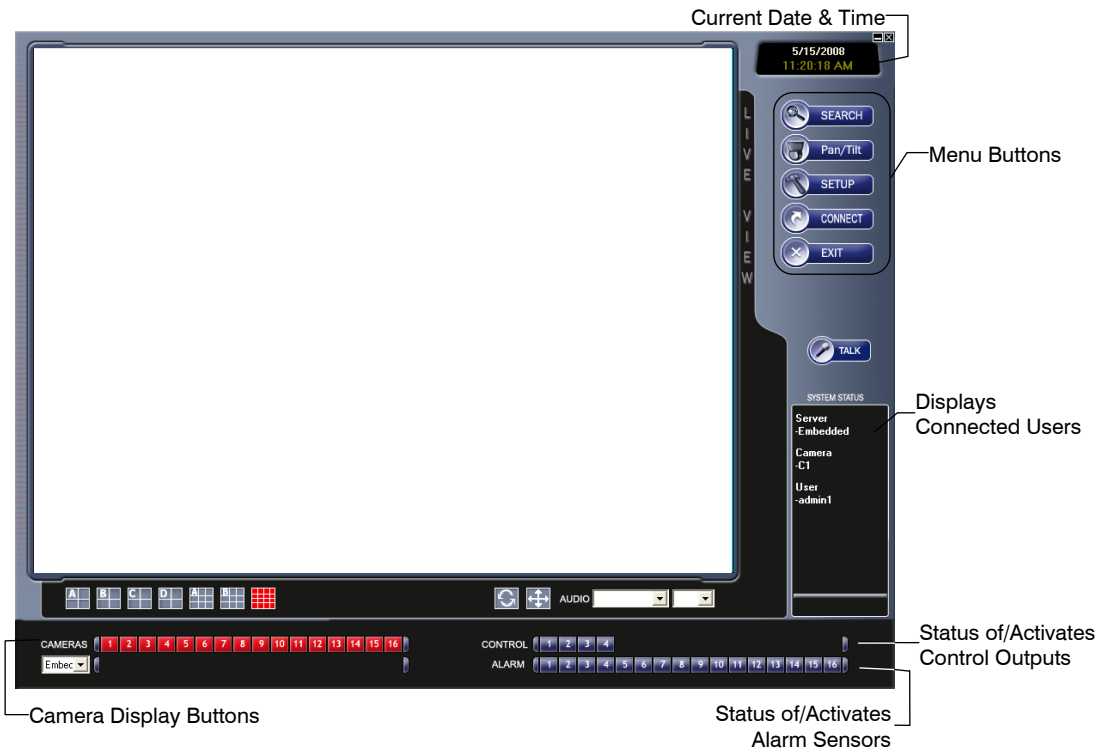



## Camera View

The Camera status for each camera is displayed on the upper right corner of the video display area.



### Recording Status Indicator

The following are the different states for each camera:

-  **Recording**      Displayed when the camera is currently being recorded to the DVR.
-  **Motion Detection**      Displayed when a camera (set up for motion detection) detects motion.
-  **Display**      Displayed when the video from the camera is currently not being recorded to the DVR.

## Screen Division Buttons

---

The Screen Division buttons allow you to view cameras in groups such as two by two, three by three and four by four. The button options are shown below.



**1st Four Cameras View** – Displays cameras 1-4 in the Video Display Area. To return to a different Multi-Camera View, select a different Screen Division option from the Screen Division Menu.



**2nd Four Cameras View** – Displays cameras 5-8 in the Video Display Area. To return to a different Multi-Camera View, select a different Screen Division option from the Screen Division Menu.



**3rd Four Cameras View** – Displays cameras 9-12 in the Video Display Area. To return to a different Multi-Camera View, select a different Screen Division option from the Screen Division Menu.



**4th Four Cameras View** – Displays cameras 13-16 in the Video Display Area. To return to a different Multi-Camera View, select a different Screen Division option from the Screen Division Menu.



**16 Camera View** – Displays cameras 1-16 in the Video Display Area. To return to a different Multi-Camera View, select a different Screen Division option from the Screen Division Menu.



**Full Screen** – The Full Screen Option allows you to view the Video Display Area using the entire viewable area on the monitor. When this is selected, no menu options are visible. You can activate the Full Screen Option by clicking Full Screen within the Screen Division Menu. You can deactivate Full Screen mode by right-clicking on the screen.



**Auto Sequence** – Sequences through the Screen Divisions sets. For example, selecting the 1A and then the Loop button will sequence through 1A, 2A, 3A, 4A and then repeat.

## Setup Overview

The Setup options allow the user to optimize the DVR by adjusting things like camera names, alarm setup, recording schedules and more. It is extremely important that the DVR is set up correctly for several reasons.

<b>Recording Schedules</b>	Increase the amount of pertinent recorded video that is saved on the DVR by optimizing the recording schedule.
<b>Camera Naming</b>	Name each camera so the location can be easily identified and include any other pertinent information that may be helpful when viewing it on the Video Display Area.
<b>Event Input</b>	Optimize the type or recording by configuring the system to begin recording or trigger an alarm when a motion or sensor event occurs.

## Setup Screen Overview

This is an expandable list with multiple levels. Click the + box next to HRDP Performance Series Setup to expand the menu tree and access the Camera, Record, Sensor Setup and System Setup details. Many of the setup options are the same in the remote software and in the DVR system. Click Apply after changing any settings.

## Camera Setup

### Camera Setup

The Camera Setup display allows the user to define camera names, power on and off cameras and define specific cameras as hidden.

**Title** - Enter camera name - up to seven characters.

**Enable** - ON/OFF [Enable individual cameras.]

**Hidden** -On/Off - On will hide the camera from logged out users.

### PanTilt Setup

The PanTilt (PTZ) Setup display allows the user to define the appropriate protocol for connected cameras with PTZ capabilities. Since setup varies between different PTZ cameras, refer to the instructions supplied by the camera's manufacturer to complete setup.

**ID** - 1 ~ 255 [Set the PTZ ID]

**PROTOCOL** -Select a PTZ protocol

## Sequence Setup

The Sequence Setup display allows the user to set the parameters for:

**Page Dwell Time** - 1 ~ 100 seconds [Set the sequence interval time for full screen on Main Display]

**Camera Dwell Time** - 1 ~ 100 seconds [Set the sequence interval time for individual cameras on Main Display]

**Channel** - 1 ~ 16 / All [Select cameras to display in Main Display]

## SPOT Setup

The SPOT Setup display allows the user to define the sequence display for individual Spot Monitors. This allows users to use different Spot Monitors to display only the video necessary for the person watching the Spot Monitor.

**Sequence** - On/Off [sequences through selected cameras]

**Interval** - 1 ~ 60 seconds [Set the sequence interval time].

**Channel** - Select cameras to include in sequence.

## Record Setup

---

### Time Setup

**Day/Night/Weekend** – Adjust the FPS and picture quality for each schedule individually.

**[C] FPS** – 0 ~25 [Define a global FPS setting for continuous recording or set individually for each channel.]

**[M] FPS** – 0 ~25 [Define a global FPS setting for motion/event recording or set individually for each channel.]

**Record Mode** – Continuous / Motion Event / C/M/E[ALL] /N/A

**Quality** – Low / Normal / High / Ultra [Define a global quality setting or set individually for each channel.]

**Post Recording** – 0 99 seconds [Recording time after event.]

**Continuous Frame** –Displays the actual FPS / maximum FPS for continuous recording

**Event Frame** – Displays the actual FPS / maximum FPS for event recording.

## Schedule Setup

**Night** – Set night time (ex. If 18:00 to 6:00 is defined as night time, 6:00 to 18:00 is defined as day time)

**Weekend** – Define weekend days

## Audio Setup

Specify volume level and audio settings for recording according to preset schedules and live or playback mode.

**Audio Day** - Enable/Disable

**Audio Night** - Enable/Disable

**Audio Weekend** - Enable/Disable

**Audio Live** - Enable/Disable

**Audio Playback** - Enable/Disable

**Volume** – 0 ~14

## Motion / Event Input

Motion / Event Setup allows you to enable recording or relay response on Motion, Sensor Event, and Video Loss

### *Motion*

**Enable**– On/Off [Enable Event Input]

**Sensitivity** – 1~5 [Define Motion sensitivity level. 1=least sensitive]

**Area** – Red=selected, White=clear. Click to select/clear boxes.[Create or clear the motion area on the camera]

### *Sensor*

**Sensor** – ON / OFF [Enable recording on sensor event.]

**Sensor Detail** – All / 1~16 / All Channel [Associate sensors with channels. Select the All check box to associate all sensors used to activate recording for that channel; Select the All Channel check box to associate the selected sensors with all channels.]

### *Video Loss*

**VideoLoss** – ON / OFF [Enable event on video loss.]

**Video Loss Detail** - All / 1~16 / All Channel [Associate video loss “V” alert with specific viewed channels. Select the All check box to prompt all channels with video loss to provide a “V” alert to the viewed channel; Select the All Channel check box to associate the selected channels to report a “V” alert when video loss occurs.]

## HDD Setup

**Disk Overwrite** – Enable / Disable [Select the check box to enable the DVR to write over old data when the hard drive is full.]

**Disk Full Warning** – Enable/Disable [Enable Disk Full Warning for notification when the HDD becomes full and HDD Overwrite is disabled.]

**Remain Time** – 0~60 [Define the amount of remaining recording time to trigger the Disk Full Warning.]

**Used Space** – 80~99 [Define the percentage HDD used that triggers the Disk Full Warning.]

**Disk Full Alarm** – 0~8 [Define the relay that will trigger when the HDD is full.]

**Disk Full Buzzer** – Enable/Disable [Enable a continuous buzzer to sound for Disk Full Warning.]

**Disk Full Message** – Enable/Disable [Enable a popup message to display for Disk Full Warning.]

## Sensor Setup

---

### Sensor

**Sensor** – N/O / N/C [Set sensors to Normally Open or Normally Closed]

**Alarm Out** – Off / On [Set Relay switches to Off or On]

---

**Note** For more information, see the  
Record > Motion/Event Configuration > Sensor section.

---

## System Setup

---

### User Management

**ID** – Type a new user name. (Available for user1 through user18.)

**Password** – Type a password for each user.

*Permissions* - Enable / Disable

**Live**

**Backup**

**PTZ**

**Health**

**Playback**

**Live Authorization** – Enable live access for specific channels.

**PTZ Authorization** – Enable PTZ control for specific channels.

### Firmware Upgrade

The HRDP Performance Series DVR can be remotely upgraded with the latest firmware. Download the firmware file to your PC, locate the file on the Firmware Upgrade screen and click Upgrade.



# Search Overview

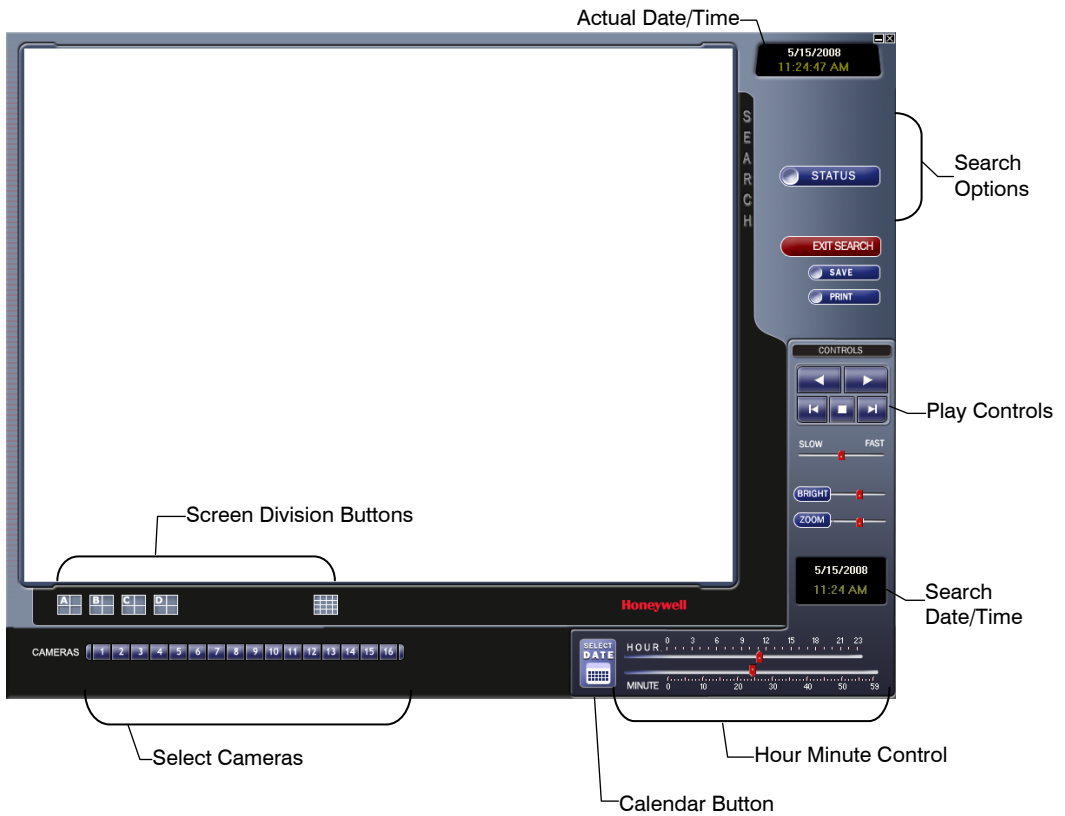

---

**Note** Audio Channel buttons are only viewable when one camera is selected.

---

## Play Controls

---

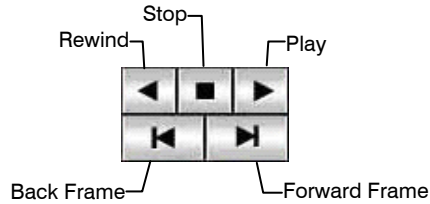

<b>Back Frame</b>	Moves video back one frame
<b>Rewind</b>	Rewinds video
<b>Stop</b>	Stops video playback
<b>Play</b>	Plays video
<b>Forward Frame</b>	Moves video forward one frame

## Performing a Basic Search

---

1. Select a date using the Calendar button on the Date Display.
2. Select a time using the hour and minute control bars.
3. Select one or more cameras.
4. Click Play. (Video can be played forwards, backwards, or frame-by-frame.)

## Adjust the Brightness of an Image

---

1. Pause the video and select an image to adjust by double-clicking the desired image. (Multiple images cannot be adjusted at one time.)
2. Move the Bright slide bar to the right or left to adjust the brightness.
3. Reset the Brightness by moving the slider back to the center of the bar.

## Zooming in on an Image

---

1. Pause the video and select an image to adjust by double-clicking on the desired image. (Multiple images cannot be adjusted at one time.)
2. Move the Zoom slide bar to the right or left to zoom in or out of an image.
3. Reset the Zoom by moving the slider back to its original position on the bar.

## Zooming in on a Portion of an Image

---

1. Using the mouse pointer, point to the area of interest on the image and click the right mouse button.
2. Keep clicking the right mouse button to zoom in further.
3. Continue clicking the right mouse button and the image zoom will cycle back to the original size.

## Printing an Image

---

1. Using the Search screen, locate a frame to print and double-click the image.

---

**Note** Only one camera can be selected at a time for this function to work.

---

2. Click the Print button. (A Print Preview window appears. Depending on the printer being used, there may be several printing options available. Refer to the printer manual for more information.)
3. Click the Page Option button to add a memo to the printout and set the paper size and orientation.
4. Click the Print button to print the selected images.

---

**Note** The message "NO DEFAULT PRINTERS INSTALLED" will display if no printer is installed.

---

## Save Clip

---

The DVR can export single images in the .JPG file format, save video clips in the .AVI format, or output to a VCR using the s-video port. The .JPG and .AVI file formats are extremely common with universal computer support making them ideal formats to use. A digital signature is also attached to every .JPG and .AVI file exported by the DVR for use with the bundled Digital Verifier application. This function is unique to the DVR and its verification software and should not interfere with viewing the files using other applications.

**JPG:** The format (.JPG) is optimized for compressing full-color or grayscale photographic images. .JPG images are 24-bit (16.7 million color) graphics. .JPG is used to export a single image or frame.

**AVI:** .AVI image data can be stored uncompressed, but it is typically compressed using a Windows-supplied or third party compression and decompression module called a codec. .AVI files save a video clip.

## Saving a Video Clip

1. Perform a basic search to locate the desired clip.
2. Click Save to open the Export Wizard.
3. Click JPEG or AVI to select the desired file type.

### AVI File

- a. Select Mark Digital Signature.
- b. Select an Audio Channel if available.
- c. Select a Compression Codec. Each codec provides different levels of quality, compatibility and file-size.
- d. Enter the duration (seconds) to record. Although 50 is the longest time displayed, a longer recording may be entered manually.
- e. Select Quality - 50 > 100. When size is not an issue, set quality to 100.

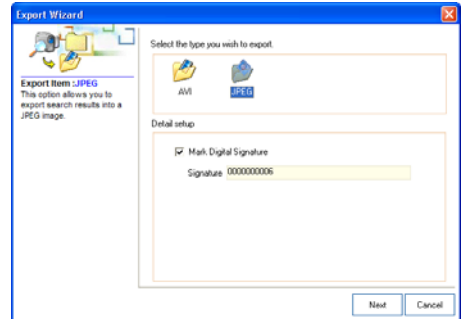

### JPEG File

- a. Select Mark Digital Signature.

4. Click Next.

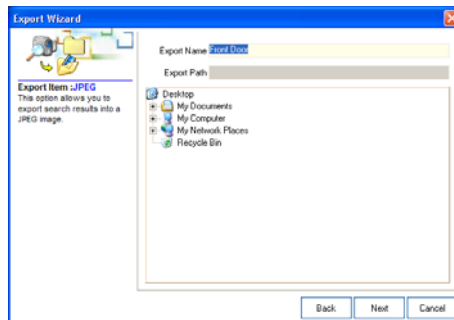

5. Define the file name in the Export Name box.
6. Define the location to save the file by using menu tree below Export Path.
7. Click Next.
8. A message displays to confirm that the save was successful.
9. Click OK. The Export Wizard will display the name, location and size of the file.
10. Click Finish.

## Status Search

The Status Search option displays a timeline in graph format. Scroll through multiple cameras and easily locate hours with recorded video.

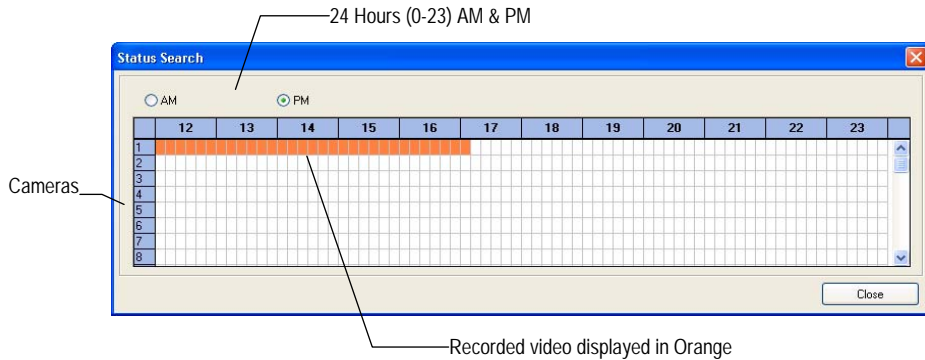

## Performing a Status Search

1. In Search mode, click Status.
2. Click the Date button to open the calendar and select a date.
3. Click along the orange recorded video block to select a desired camera or time frame.
4. After locating the desired video, close the Status Search window and use the playback controls to play forward, reverse or frame-by-frame.

## PTZ Overview

### Accessing PTZ Menus

---

Some protocols support the ability to access the Internal PTZ Onscreen Menu. Click PAN/TILT on the remote software Live View screen to open the graphical PTZ controller.

Some protocols support the ability to access the Internal PTZ Onscreen Menu.

Since every PTZ camera is different, the functions of these options can vary slightly.

The Performance Series DVR provides an easy way to access the cameras options. For explanations of what those options are please refer to the manual that came with the camera.

---

**Note** Use the arrow buttons on the PTZ controller move through the PTZ Menu options and/or highlight options.

---



### Controlling a PTZ Camera

---

- The first method is to use the graphical PTZ Controller that appears when PAN/TILT is clicked on the Live View screen.
- The second method is to use the mouse to control the camera directly from the live video display.

## Using the Graphical PTZ Controller

---

- Use the Arrow buttons to control the direction of the PTZ camera.
- To select a new camera, click the video display of a different camera on the Live View screen.

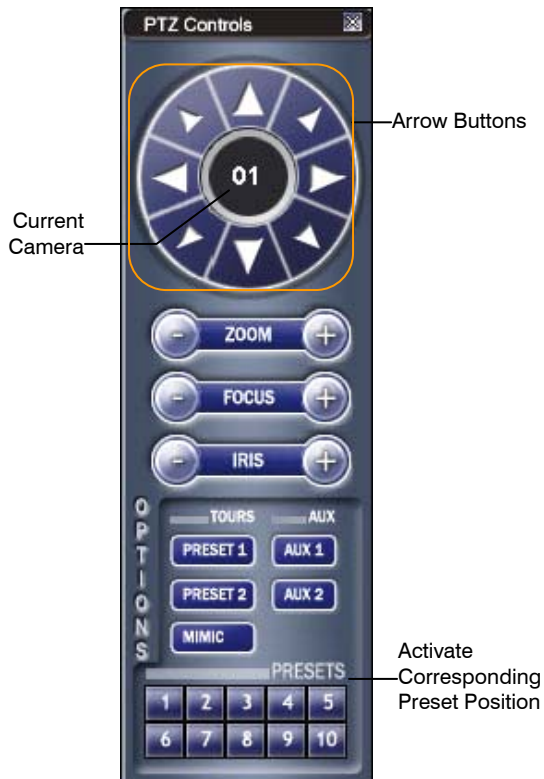

---

**Note** Eight directions are available only for select protocols. Only four of the PTZ Control buttons work for all protocols (UP, DOWN, LEFT, RIGHT).

---

## Using the On-screen Compass

---



1. Click PAN/TILT on the Live View screen.
2. Control the PTZ by dragging the mouse on the screen in the desired direction.

A green line will appear to show the direction the PTZ will move. The shorter the line the less the PTZ will move. The longer the line the more the PTZ will travel in the specified direction.



---

## Web Viewer Overview

---

The DVR allows access to the video using Microsoft® Internet Explorer® browser 6+.

To log in to the DVR server from the Web Viewer, a user account must be made for the user. This ensures that only authorized users are allowed to log in. In addition, each user can be assigned different privileges that allow or deny access to different functions.

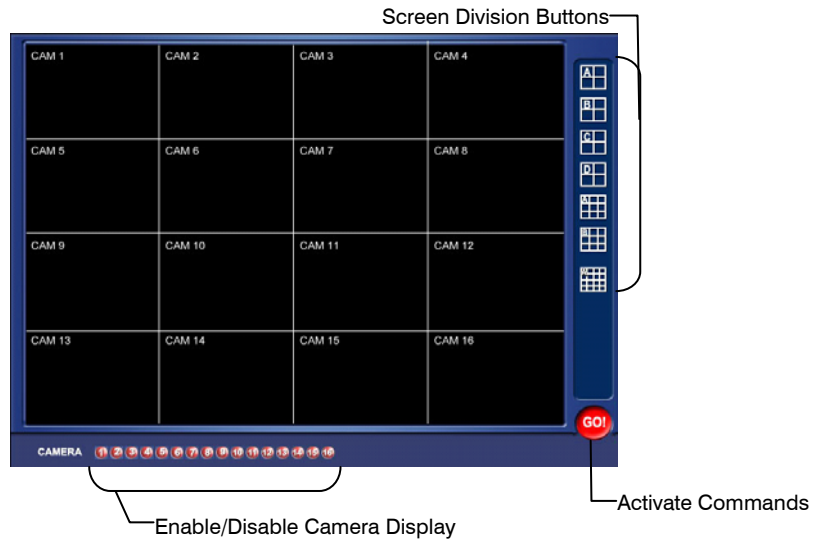

## Connecting to a DVR Using Web Viewer

1. Open Microsoft Internet Explorer.
2. Enter the IP address of the DVR into the Address bar.
3. When attempting this for the first time you will be asked to accept an Active X installation. Click Yes.

---

**Note** If you receive a message saying Internet Explorer security settings do not allow you to download Active X components then you will need to adjust the browser security settings. Add the IP address of the DVR to the trusted sites list inside Internet Explorer settings. Contact the System administrator for additional help with adjusting Internet Explorer settings.

---

4. When the Web Viewer finishes loading, select one or more cameras (or select a screen division button).
5. Click GO!
6. A login window will appear. Enter the Username and Password of an authorized user.
7. The cameras will now display.

## Closing the Web Viewer

To exit the Web Viewer close Internet Explorer.

## Digital Verifier Overview

.JPG images and .AVI video files that are exported from the Digital Video Recorder are automatically embedded with a digital signature. Digital Signatures are a way to verify the authenticity of the images to ensure that they have not been tampered with or edited in any way. Included on the Software Installation DVD, supplied with the DVR, is the Digital Signature Verification program. This program can be installed on any computer and loads an image in question.

## Using the Digital Verifier

1. Open the Digital Verification program by selecting Start > Programs > HRDP > Digital Verifier > Digital Signature Verifier.
2. Click the Browse button to load the .JPG image.
3. Enter the Site Code of the DVR that the image was originally extracted from. (The Site Code is specified in the System Configuration Menu)
4. Click Verify to continue or Close to close the window without verifying.

If the image has not been tampered with, a blue square will appear around the image with the message "Original image file."

If the image has been tampered with, a red square will appear around the image with the message "Entire image changed or wrong SITE CODE."

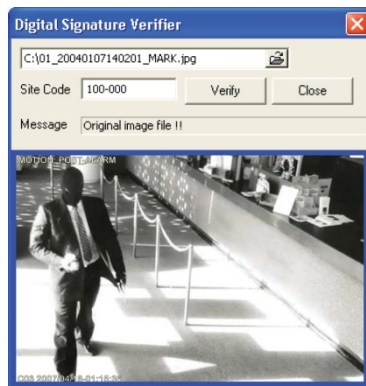

# Appendix

---

## DVR FAQ

---

### General

**Q.** What does Embedded Linux mean?

**A.** Embedded Linux means that the operating system of the DVR has been imprinted into the CPU (Central Processing Unit). This means that the system response time is faster, more stable, and that the core of the DVR is protected against external factors, such as virus.

**Q.** Is the DVR upgradeable by CD or network?

**A.** Yes.

**Q.** How can I reset the DVR to the factory default settings?

**A.** Load the factory default settings from the System Configuration Menu.

### Live Monitoring

**Q.** Is it possible to monitor the live video of specific cameras?

**A.** You can set the camera sequence through Spot/Sequence Configuration or by connecting to one of the 3 spot monitor outputs on the rear of the DVR unit.

### Recording

**Q.** How do you record?

**A.** For information on this topic view the Recording Configuration section of this manual.

## Recording Continued

---

**Q.** What is Time Recording?

**A.** Time recording is recording scheduled to occur regardless of whether a motion or alarm event occurs.

---

**Q.** What is Event Recording?

**A.** Event Recording is recording which is activated when an event (motion or alarm) occurs.

## Searching and Playing Video

---

**Q.** How do I play back recorded video?

**A.** For more information on this topic, see the Search section of this manual.

---

**Q.** Is it possible to back up recorded video?

**A.** Yes, for more information on this topic see the Backup section of this manual.

## Backup

---

**Q.** Is it possible to back up to DVD media?

**A.** Yes, you have DVD-RW installed in your DVR.

---

**Q.** Can I back up to a USB memory stick?

**A.** Yes, for more information on this topic view the Backup section of this manual.

## Network

---

**Q.** Does it support dynamic IP?

**A.** Yes. Enable DHCP in Network Configuration.

---

**Q.** Mail is not sent out.

**A.** Please check all the settings in the Network E-Mail Configuration.

## Miscellaneous

---

**Q.** What types of cameras can be used?

**A.** The Honeywell Performance Series DVR supports either NTSC or PAL analog cameras. Both standards may not be used simultaneously.

---

---

## Troubleshooting

---

<b>Problem</b>	<b>Possible Solutions</b>
No Power	Check the power cord connections Check power at the outlet
No Live Video	Check camera video cable and connections Check monitor video cable and connections Check camera power Check camera lens setting
Live Video Too Bright	If a cable is attached to the video channels looping output, make sure that it is properly terminated.
DVR has stopped recording	The HDD is full, delete video or set the DVR Overwrite Mode to On in Disk Configuration > Overwrite.

## Specifications (HRDP)

Specification		4 Channel	8 Channel	16 Channel
Video	Inputs	• 4 Channel Composite	• 8 Channel Composite	• 16 Channel Composite
	Outputs	• CCTV Monitor (NTSC/PAL), • CRT(VGA) Monitor	• CCTV Monitor (NTSC/PAL), • CRT(VGA) Monitor	• CCTV Monitor (NTSC/PAL), • CRT(VGA) Monitor • S-Video (NTSC/PAL)
		• 4 CH Looping Composite • 1 Spot CCTV Monitor (NTSC/PAL)	• 8 CH Looping Composite • 1 Spot CCTV Monitor (NTSC/PAL)	• 16 CH Looping Composite • 3 Spot CCTV Monitor (NTSC/PAL)
Monitoring	Display	• NTSC : 120 fps • PAL : 100 fps	• NTSC : 480 fps • PAL : 400 fps	
	Screen split	• 1/4	• 1/4/7/9	• 1/4/7/9/10/13/16
Recording	Performance	• NTSC: CIF(120 fps), 2CIF(60 fps), 4CIF (30 fps) • PAL: CIF(100 fps), 2CIF (50 fps), 4CIF(25 fps)		
	Resolution	• NTSC: CIF(352x240), 2CIF(704x240), 4CIF (704x480) • PAL: CIF(352x288), 2CIF (704x288), 4CIF(704x576)		
	Compression	• Enhanced MPEG-4		
	Mode	• Motion detection, Sensor, Schedule • Variable compression rates, recording frame, motion sensitivity		
Recording	Storage media	• Internal 2 x HDD (Option) • USB		
	Audio	• 1 Channel, G.726 Compression		
Playback	Mode	• Multi-channel playback (Max 16ch), Simultaneous/Panorama/Smart playback		
	Searching	• By Channel, Time, Date, Motion Detection, Sensor Events		
Remote Monitoring S/W		• Remote Software / Web based viewer		
Alarm		• 1	• 1	• 4
Sensor		• 4	• 8	• 16
Camera Control		• Pan/Tilt, Zoom, Focus, Iris		
Back-up		• DVD+/-RW • USB		
Hardware Spec.	Size	• 15.75" (W) x 3.46" (H) x 15.75" (D) (400 mm x 88 mm x 400 mm)		
	Weight	• 15 lb (6.8 kg)W/O Packing		
	Power	• Input Voltage is 110-230V ~ 47/63Hz 1.75-.85A		
	UPS	• External UPS recommended		





NOTES:

**Honeywell Video Systems (Head Office)**

2700 Blankenbaker Pkwy, Suite 150  
Louisville, KY 40299, USA  
[www.honeywellvideo.com](http://www.honeywellvideo.com)

☎ +1.800.796.2288

**Honeywell Security Australia Pty Ltd.**

Unit 5, Riverside Center, 24-28 River Road West  
Parramatta, NSW 2150, Australia  
[www.honeywellsecurity.com.au](http://www.honeywellsecurity.com.au)

☎ +61.2.8837.9300

**Honeywell Security Asia Pacific**

33/F Tower A, City Center, 100 Zun Yi Road  
Shanghai 200051, China  
[www.asia.security.honeywell.com](http://www.asia.security.honeywell.com)

☎ +86 21.5257.4568

**Honeywell Security Asia**

Flat A, 16/F, CDW Building, 388 Castle Peak Road  
Tsuen Wan, N.T., Hong Kong  
[www.asia.security.honeywell.com](http://www.asia.security.honeywell.com)

☎ +852.2405.2323

**Honeywell Security South Africa**

Honeywell House, Bekker Street  
Truer Close, Waterfall Park  
Midrand 1685, South Africa  
[www.honeywell.com/security/za](http://www.honeywell.com/security/za)

☎ +27.11.695.8000

**Honeywell Security Middle East**

Honeywell Middle East FZE  
Post Office Box 18530  
LOB Building 08, Office 199  
Jebel Ali, Dubai U.A.E.  
[www.honeywell.com/security/me](http://www.honeywell.com/security/me)

☎ +971.04.881.5506

**Honeywell Security UK**

Aston Fields Road, Whitehouse Ind Est  
Runcorn, Cheshire, WA7 3DL, UK  
[www.honeywell.com/security/uk](http://www.honeywell.com/security/uk)

☎ +44.1928.756.999

**Honeywell Video Systems Northern Europe**

Netwerk 121  
1446 WV Purmerend, The Netherlands  
[www.honeywell.com/security/nl](http://www.honeywell.com/security/nl)

☎ +31.299.410.200

**Honeywell Security Deutschland**

Johannes-Mauthé-Straße 14  
D-72458 Albstadt, Germany  
[www.honeywell.com/security/de](http://www.honeywell.com/security/de)

☎ +49.74 31.8 01.0

**Honeywell Security France**

Parc Gutenberg, 8, Voie La Cardon  
91120, Palaiseau, France  
[www.honeywell.com/security/fr](http://www.honeywell.com/security/fr)

☎ +33.01.64.53.80.40

**Honeywell Security Italia SpA**

Via della Resistenza 53/59  
20090 Buccinasco  
Milan, Italy  
[www.honeywell.com/security/it](http://www.honeywell.com/security/it)

☎ +39.02.4888.051

**Honeywell Security España**

Mijancas 1. 3a planta  
P.Ind. Las Mercedes  
28022 Madrid, Spain  
[www.honeywell.com/security/es](http://www.honeywell.com/security/es)

☎ +34.902.667.800

# Honeywell

[www.honeywellvideo.com](http://www.honeywellvideo.com)  
**+1.800.796.CCTV (North America only)**  
[HVSsupport@honeywell.com](mailto:HVSsupport@honeywell.com)

Document 800-02089 Rev B– 06/08

© 2008 Honeywell International Inc. All rights reserved. No part of this publication may be reproduced by any means without written permission from Honeywell Video Systems. The information in this publication is believed to be accurate in all respects. However, Honeywell Video Systems cannot assume responsibility for any consequences resulting from the use thereof. The information contained herein is subject to change without notice. Revisions or new editions to this publication may be issued to incorporate such changes.

## Free Manuals Download Website

<http://myh66.com>

<http://usermanuals.us>

<http://www.somanuals.com>

<http://www.4manuals.cc>

<http://www.manual-lib.com>

<http://www.404manual.com>

<http://www.luxmanual.com>

<http://aubethermostatmanual.com>

Golf course search by state

<http://golfingnear.com>

Email search by domain

<http://emailbydomain.com>

Auto manuals search

<http://auto.somanuals.com>

TV manuals search

<http://tv.somanuals.com>