

FUSION DVR

Digital Recording and Transmission System

User Manual



ISSUE	DATE	REVISIONS
A	October 2003	Initial Release (PCN 1572)
B	January 2004	Revised PTZ information.
C	March 2004	Updated format and content (PCN 1718).
D	June 2004	Updated format and content.
E	October 2004	Updated content, clarified ambiguous feature descriptions, and updated DVR chassis images.
F	November 2004	Updated content for v.2.3.2 software release.
G	January 2005	Updated G2 images and UL power safety requirements.
H	January 2005	Updated format and content.
J	March 2005	Updated content. Formatting of: headings used in TOC, covers, barcode

FCC COMPLIANCE STATEMENT

INFORMATION TO THE USER: THIS EQUIPMENT HAS BEEN TESTED AND FOUND TO COMPLY WITH THE LIMITS FOR A CLASS A DIGITAL DEVICE, PURSUANT TO PART 15 OF THE FCC RULES. THESE LIMITS ARE DESIGNED TO PROVIDE REASONABLE PROTECTION AGAINST HARMFUL INTERFERENCE WHEN THE EQUIPMENT IS OPERATED IN A COMMERCIAL ENVIRONMENT. THIS EQUIPMENT GENERATES, USES, AND CAN RADIATE RADIO FREQUENCY ENERGY AND, IF NOT INSTALLED AND USED IN ACCORDANCE WITH THE INSTRUCTION MANUAL, MAY CAUSE HARMFUL INTERFERENCE TO RADIO COMMUNICATIONS. OPERATION OF THIS EQUIPMENT IN A RESIDENTIAL AREA IS LIKELY TO CAUSE HARMFUL INTERFERENCE IN WHICH CASE THE USER WILL BE REQUIRED TO CORRECT THE INTERFERENCE AT HIS OWN EXPENSE.

CAUTION: CHANGES OR MODIFICATIONS NOT EXPRESSLY APPROVED BY THE PARTY RESPONSIBLE FOR COMPLIANCE COULD VOID THE USER'S AUTHORITY TO OPERATE THE EQUIPMENT.

THIS CLASS A DIGITAL APPARATUS COMPLIES WITH CANADIAN ICES-003.

CET APPAREIL NUMÉRIQUE DE LA CLASSE A EST CONFORME À LA NORME NMB-003 DU CANADA.

OPERATION OF THIS DEVICE IS SUBJECT TO THE FOLLOWING CONDITIONS:

- THIS DEVICE MAY NOT CAUSE HARMFUL INTERFERENCE.
- THIS DEVICE MUST ACCEPT INTERFERENCE RECEIVED, INCLUDING INTERFERENCE THAT MAY CAUSE UNDESIRABLE OPERATION.
- CABLES USED WITH THIS DEVICE MUST BE PROPERLY SHIELDED TO COMPLY WITH THE REQUIREMENTS OF THE FCC.
- YOU ARE CAUTIONED THAT ANY CHANGES OR MODIFICATIONS NOT EXPRESSLY APPROVED IN THIS MANUAL COULD VOID YOUR AUTHORITY TO OPERATE THIS EQUIPMENT.

USERS OF THE PRODUCT ARE RESPONSIBLE FOR CHECKING AND COMPLYING WITH ALL FEDERAL, STATE, AND LOCAL LAWS AND STATUTES CONCERNING THE MONITORING AND RECORDING OF VIDEO AND AUDIO SIGNALS. HONEYWELL VIDEO SYSTEMS SHALL NOT BE HELD RESPONSIBLE FOR THE USE OF THIS PRODUCT IN VIOLATION OF CURRENT LAWS AND STATUTES.

NATIONAL POWER DEVIATION STANDARDS

AUSTRALIA / NEW ZEALAND

COMPONENTS COMPLY WITH THE RELEVANT PORTIONS OF IEC 60950 OR THE APPLICABLE COMPONENT STANDARD OR THE RELEVANT AUSTRALIAN / NEW ZEALAND STANDARD.

AC POWER DISTRIBUTION SYSTEMS CLASSIFIED AS TT OR IT ARE NOT ALLOWED INTENDED FOR USE ON A TN SYSTEM.

Rated
Current of
Equipment
(A) Nominal
cross-sectional
area
(mm²)

0.2	<=	3 0.5*
3	<=	7.5 0.75
7.5	<=	10 (0.75) 1.00
10	<=	16 (1,0) 1.5
16	<=	25 2.5
25	<=	32 4
32	<=	40 6
40	<=	63 10
63	<=	80 16
80	<=	100 25
100	<=	125 35
125	<=	160 50
160	<=	190 70
190	<=	230 95

DENMARK

CERTAIN TYPES OF CLASS I APPLIANCES MAY BE PROVIDED WITH PLUG NOT ESTABLISHING EARTHING CONTINUITY WHEN INSERTED INTO DANISH SOCKET-OUTLETS.

"VIGTIGT !

LEDEREN MED GRØN/GUL ISOLATION MÅ KUN

TILSLUTTES EN KLEMME MÆRKET

(IEC 417, NO. 5019) ELLER (IEC 417, NO. 5017)

**FOR TILSLUTNING AF DE ØVRIGE LEDERE, SE MEDFØLGENDE
INSTALLATIONSVEJLEDNING**

SUPPLY CORD OF SINGLE-PHASE EQUIPMENT HAVING A RATED CURRENT NOT EXCEEDING 13 A SHALL BE PROVIDED WITH A PLUG ACCORDING TO THE HEAVY CURRENT REGULATIONS, SECTION 107-2-D1. CLASS I EQUIPMENT PROVIDED WITH SOCKET-OUTLETS WITH EARTH CONTACT OR WHICH ARE INTENDED TO BE USED IN LOCATIONS WHERE PROTECTION AGAINST INDIRECT CONTACT IS REQUIRED ACCORDING TO THE WIRING RULES SHALL BE PROVIDED WITH A PLUG IN ACCORDANCE WITH STANDARD SHEET DK 2-1A OR DK 2-5A. IF POLY-PHASE EQUIPMENT AND SINGLE-PHASE

EQUIPMENT HAVING A RATED CURRENT EXCEEDING 13 A IS PROVIDED WITH A SUPPLY CORD WITH A PLUG, THIS PLUG SHALL BE IN ACCORDANCE WITH THE HEAVY CURRENT.

GERMANY

(GESETZ UBER TECHNISCHE ARBEITSMITTEL (GERATESICHERHEITSGESETZ) [LAW OF TECHNICAL LABOUR EQUIPMENT {EQUIPMENT SAFETY LAW}], OF 23RD OCTOBER 1992, ARTICLE 3, 3RD PARAGRAPH, 2ND SENTENCE, TOGETHER WITH THE "ALLGEMEINE VERWALTUNGSVORSCHRIFT ZUR URCHFUHRUNG DES ZWEITEN ABSCHRITTS DES GERATESICHERHEITSGESETZES" [GENERAL ADMINISTRATIVE REGULATION ON THE EXECUTION OF THE SECOND SECTION OF THE EQUIPMENT SAFETY LAW], OF 10TH JANUARY 1996, ARTICLE 2, THE PARAGRAPH, ITEM 2).

KOREA

PLUGS FOR THE CONNECTION OF THE APPARATUS TO THE SUPPLY MAINS COMPLY WITH THE KOREAN REQUIREMENT (KSC 8305).

EMC - THE APPARATUS SHALL COMPLIES WITH THE RELEVANT CISPR STANDARDS.

SWITZERLAND

SUPPLY CORDS OF EQUIPMENT HAVING A RATED CURRENT NOT EXCEEDING 10 A SHALL BE PROVIDED WITH A PLUG

COMPLYING WITH SEV 1011 OR IEC 60884-1 AND ONE OF THE FOLLOWING DIMENSION SHEETS:

SEV 6532-2.1991, PLUG TYPE 15, 3P+N+PE 250/400 V,10 A

SEV 6533-2.1991, PLUG TYPE 11, L+N 250 V,10 A

SEV 6534-2.1991, PLUG TYPE 12, L+N+PE 250 V,10 A

IN GENERAL, EN 60309 APPLIES FOR PLUGS FOR CURRENTS EXCEEDING 10 A. HOWEVER, A 16 A PLUG AND SOCKETOUTLET SYSTEM IS BEING INTRODUCED IN SWITZERLAND, THE PLUGS OF WHICH ARE ACCORDING TO THE FOLLOWING DIMENSION SHEETS, PUBLISHED IN FEBRUARY 1998:

SEV 5932-2.1998, PLUG TYPE 25, 3P+N+PE 230/400 V,16 A

SEV 5933-2.1998, PLUG TYPE 21, L+N 250 V,16 A

SEV 5934-2.1998, PLUG TYPE 23, L+N+PE 250 V,16 A

UNITED KINGDOM

THE CURRENT RATING OF THE CIRCUIT SHALL BE TAKEN AS 13 A, NOT 16 A.

RATING OF CIRCUIT UNDER TEST WAS TAKEN TO BE 20 A.

APPARATUS WHICH IS FITTED WITH A FLEXIBLE CABLE OR CORD AND IS DESIGNED TO BE CONNECTED TO A MAINS SOCKET CONFORMING TO BS 1363 BY MEANS OF THAT FLEXIBLE CABLE OR CORD AND PLUG, SHALL BE FITTED WITH A "STANDARD PLUG" IN ACCORDANCE WITH STATUTORY INSTRUMENT 1786: 1994 - THE PLUGS AND SOCKETS ETC. (SAFETY) REGULATIONS 1994, UNLESS EXEMPTED BY THOSE REGULATIONS. NOTE: "STANDARD PLUG" IS DEFINED IN SI 1786: 1994 AND ESSENTIALLY MEANS AN APPROVED PLUG CONFORMING TO BS 1363 OR AN APPROVED CONVERSION PLUG.

RACK MOUNT INSTRUCTIONS

- A) Elevated Operating Ambient – If installed in a closed or multi-unit rack assembly, the operating ambient temperature of the rack environment may be greater than room ambient. Therefore, consideration should be given to installing the equipment in an environment compatible with the maximum ambient temperature (T_{ma}) specified by the manufacturer.
- B) Reduced Air Flow – Installation of the equipment in a rack should be such that the amount of air flow required for safe operation of the equipment is not compromised.
- C) Mechanical Loading – Mounting of the equipment in the rack should be such that a hazardous condition is not achieved due to uneven mechanical loading.
- D) Circuit Overloading – Consideration should be given to the connection of the equipment to the supply circuit and the effect that overloading of the circuits might have on over current protection and supply wiring. Appropriate consideration of equipment nameplate ratings should be used when addressing this concern.
- E) Reliable Earthing – Reliable earthing of rack-mounted equipment should be maintained. Particular attention should be given to supply connections other than direct connections to the branch circuit (e.g. use of power strips).

UL NOTICE

Underwriters Laboratories Inc. has not tested the performance or reliability of the security or signaling aspects of this product. UL has only tested for fire, shock and casualty hazards as outlined in UL's Standard for Safety UL 60950-1. UL Certification does not cover the performance or reliability of the security or signaling aspects if this product. UL MAKES NO REPRESENTATIONS, WARRANTIES OR CERTIFICATIONS WHATSOEVER REGARDING THE PERFORMANCE OR RELIABILITY OF ANY SECURITY OR SIGNALING RELATED FUNCTIONS OF THIS PRODUCT.

CE NOTICE

This product is in conformity with the following European Directives:

ELECTROMAGNETIC COMPATIBILITY DIRECTIVE, 89/336/EEC
(as amended by 92/31/EEC and by Article 5 of 93/68/EEC)

per the provisions of:

EN 55022:1994	EN 55024:1998	EN 61000-4-4:1995
EN 61000-3-2:1995	CISPR 24:1997	EN 61000-4-5:1995
EN 61000-3-3:1995	EN 61000-4-2:1995	EN 61000-4-6:1995
CISPR 22:1997	EN 61000-4-3:2002	EN 61000-4-11:1994

LOW VOLTAGE DIRECTIVE, 73/23/EEC
(as amended by Article 13 of 93/68/EEC)

per the provisions of:

EN 60950-1: 2001

EN 50130-4:1996 Notice

1. Uninterrupted Power supply (UPS)
2. Maximum lengths of wiring connected to the sensor inputs and control outputs are 30 meters.

EN 55022 CLASS A Notice

WARNING

This is a class A product. In a domestic environment this product may cause radio interference in which case the user may be required to take adequate measures.

OPTICAL AND ACOUSTICAL STATEMENTS

VISIBLE LED STATEMENT

The LEDs on this DVR unit are classified as "Class 1 LED Product" in accordance with EN 60825-1.

LASER SAFETY STATEMENT FOR A CLASS 1 LASER PRODUCT

This CD-ROM Storage device has been tested and found to comply with the limits for a Class B digital device, pursuant to Part 15 of the FCC Rules. These limits are designed to provide reasonable protection against harmful interference when the equipment is operated in a residential installation. This equipment generates, uses, and can radiate radio frequency energy and if not installed and used in accordance with the instruction manual may cause harmful interference. If this equipment does cause harmful interference to radio or television reception, the user is can attempt to correct this by following one or more of the following measures:

- Reorient or relocate the receiving antenna.
- Increase the separation between the equipment and the receiver.
- Connect the equipment into an outlet on a circuit different from that which the receiver is connected.
- Consult the dealer or an experienced radio TV technician for help.

The mass storage system does not product hazardous laser radiation. Because laser light emitted inside the mass storage system is completely confined within the protective housings and external covers, the laser beam cannot escape from the machine during any phase of user operation.



CAUTION: Due to the extremely fast rotation speed of the CD-ROM drive spindle motor (9000 ~ 12000 rpm), the drive's performance could be affected by using substandard discs. These substandard discs may be damaged, or damage the CD-ROM drive.

- Check each CD for cracks before using it. If there are cracks on the surface, especially on the border of the center hole, do not use it in the CD-ROM drive. Using such CDs can cause irreparable damage to the CD-ROM drive.
- Do not leave CDs in direct sunlight or hot, humid locations.
- Always remove CDs from the drive after use.
- To protect CDs from scratches, never touch the CD face or place the CD face down on a hard surface.
- Do not affix highly adhesive stickers to a CD.

VISIBLE LED STATEMENT

Lpa < 70 dB operator position, normal operation, per ISO 7779.

IMPORTANT SAFEGUARDS

1. **Read Owner's Manual** – After unpacking this product, read the owner's manual carefully, and follow all the operating and other instruction
2. **Power Sources** – This product should be operated only from the type of power source indicated on the label. If you are not sure of the type of power supply to your home or business, consult your product dealer or local power company
3. **Ventilation** – Slots and openings in the cabinet are provided for ventilation and to ensure reliable operation of the product and to protect it from overheating, and these openings must not be blocked or covered. The product should not be placed in a built-in installation such as a bookcase or rack unless proper ventilation is provided or the manufacturer's instructions have been adhered to.
4. **Heat** – The product should be situated away from heat sources such as radiators, heat registers, stoves, or other products that produce heat.
5. **Water and Moisture** – Do not use this product near water. Do not exceed the humidity specifications for the product as detailed in the Appendix section in this manual
6. **Cleaning** – Unplug this product from the wall outlet before cleaning. Do not use liquid cleaners or aerosol cleaners. Use a damp cloth for cleaning.
7. **Power Cord Protection** – Power-supply cords should not be routed so that they are not likely to be walked on or pinched by items placed against them, paying particular attention to cords at plugs, convenience receptacles, and the point where they exit from the product.
8. **Overloading** – Do not overload wall outlets; extension cords, or integral convenience receptacles as this can result in a risk of fire or electrical shock.
9. **Lightning** – For added protection for this product during storm, or when it is left unattended and unused for long periods of time, unplug it from the wall outlet. This will prevent damage to the product due to lightning and power line surges.
10. **Object and Liquid Entry Points** – Never insert foreign objects into the DVR unit, other than the media types approved by Honeywell, as they may touch dangerous voltage points or short-out parts that could result in a fire or electrical shock. Never spill liquid of any kind on the product.
11. **Accessories** – Do not place this product on an unstable cart, stand, tripod, bracket, or table. The product may fall, causing serious personal injury and serious damage to the product.
12. **Disc Tray** – Keep your fingers well clear of the disc tray as it is closing. Neglecting to do so may cause serious personal injury.
13. **Burden** – Do not place a heavy object on or step on the product. The object may fall, causing serious personal injury and serious damage to the product.
14. **Disc** – Do not use a cracked, deformed, or repaired disc. These discs are easily broken and may cause serious personal injury and product malfunction.

IMPORTANT SAFEGUARDS, CONTINUED

15. **Damage Requiring Service** – Unplug the unit from the outlet and refer servicing to qualified service personnel under the following conditions:
 - a. When the power-supply cord or plug is damaged.
 - b. If liquid has been spilled, or objects have fallen into the unit.
 - c. If the unit has been exposed to rain or water.
 - d. If the unit does not operate normally by following the operating instructions. Adjust only those controls that are covered by the operating instructions as an improper adjustment of other controls may result in damage and will often require extensive work by a qualified technician to restore the unit to its normal operation.
 - e. If the unit has been dropped or the enclosure has been damaged.
 - f. When the unit exhibits a distinct change in performance - this indicates a need for service.
16. **Servicing** – Do not attempt to service this product yourself as opening or removing covers may expose you to dangerous voltage or other hazards. Refer all servicing to qualified personnel.
17. **Replacement Parts** – When replacement parts are required, be sure the service technician has used replacement parts specified by the manufacturer or have the same characteristics as the original part. Unauthorized substitutions may result in fire, electric shock or other hazards.
18. **Safety Check** – Upon completion of any service or repairs to this unit, ask the service technician to perform safety checks to determine that the unit is in proper operating condition.

NOTES ON HANDLING

- When shipping the DVR unit, the original shipping carton packing materials come in handy. For maximum protection, repack the unit as it was originally packed at the factory.
- Do not use volatile liquids, such as insect spray, near the DVR unit. Do not leave rubber or plastic products in contact with the DVR unit for long periods of time. They will leave marks on the finish.
- The top and rear panels of the DVR unit may become warm after long periods of use. This is not a malfunction.

NOTES ON LOCATING

- Place the DVR unit on a level surface. Do not use it on a shaky or unstable surface such as a wobbling table or inclined stand.
- When you place this DVR unit next to a TV, radio, or VCR, the playback picture may become poor and the sound may be distorted. If this happens, place the DVR unit away from the TV, radio, or VCR.

IMPORTANT SAFEGUARDS, CONTINUED

NOTES ON CLEANING

- Use a soft dry cloth for cleaning.
- For stubborn dirt, soak the cloth in a weak detergent solution, wring well and wipe. Use a dry cloth to wipe it dry. Do not use any type of solvent, such as thinner and benzene, as they may damage the surface of the DVR unit.
- If you use a chemical saturated cloth to clean the unit, follow that product's instructions.

NOTES ON MAINTENANCE

This DVR unit is designed to last for long periods of time. To keep your DVR unit always operational we recommend regular inspection maintenance (cleaning parts or replacement). For details contact your nearest dealer.

NOTES ON MOISTURE CONDENSATION

Moisture condensation damages the DVR unit. Read the following information carefully.

Moisture condensation occurs during the following cases:

- When you bring the DVR unit directly from a cold place to a warm place.
- When you use the DVR unit in a room where you just turned on the heater, or a place where the cold wind from the air conditioner directly hits the unit.
- In the summer, when you use the DVR unit in a hot and humid place just after you move the unit from an air conditioned room.
- When you use the DVR unit in a humid place.

Do not use the DVR unit when moisture condensation may occur.

If you use the DVR unit in such a situation, it may damage discs and internal parts. Remove any CD discs, connect the power cord of the DVR unit to the wall outlet, turn on the DVR unit, and leave it for two to three hours. After two to three hours, the DVR unit will have warmed up and evaporated any moisture. Keep the DVR unit connected to the wall and moisture will seldom occur.

WARNING

TO REDUCE THE RISK OF ELECTRICAL SHOCK, DO NOT EXPOSE THIS APPLIANCE TO RAIN OR MOISTURE.

DANGEROUS HIGH VOLTAGES ARE PRESENT INSIDE THE ENCLOSURE.
DO NOT OPEN THE CABINET.

REFER SERVICING TO QUALIFIED PERSONNEL ONLY.

CAUTION

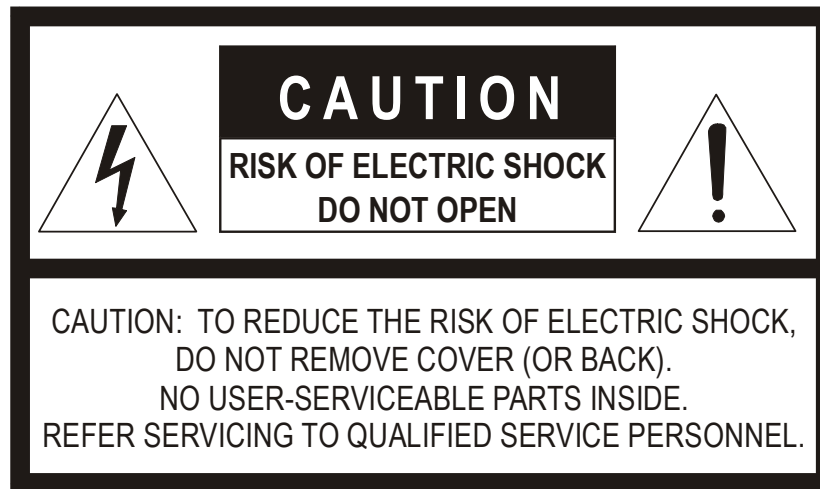

EXPLANATION OF GRAPHICAL SYMBOLS



The lightning flash with arrowhead symbol, within an equilateral triangle, is intended to alert the user to the presence of uninsulated "dangerous voltage" within the product's enclosure that may be of sufficient magnitude to constitute a risk of electric shock to persons.



The exclamation point within an equilateral triangle is intended to alert the user to the presence of important operating and maintenance (servicing) instruction in the literature accompanying the product.



The circle with inward pointing arrows is intended to alert the user to the presence of sensitive electronic components susceptible to Electro Static Discharge. The utmost care should be exercised in ensuring proper grounding before handling these components.

TABLE OF CONTENTS

SECTION 1 INTRODUCTION.....	1-1
1.1 PRODUCT DESCRIPTION.....	1-1
1.2 FEATURES.....	1-1
SECTION 2 CONTROLS AND CONNECTIONS.....	2-1
2.1 BASIC FEATURES.....	2-1
2.2 FRONT PANEL CONTROLS AND LEDS.....	2-2
2.3 REAR PANEL CONNECTORS.....	2-2
SECTION 3 GETTING STARTED	3-1
3.1 IDENTIFYING INCLUDED COMPONENTS.....	3-1
3.2 KEYBOARD SETUP	3-2
3.3 MOUSE SETUP	3-2
3.4 MONITOR SETUP	3-3
3.5 POWER SETUP.....	3-3
3.6 CONNECTING A VIDEO SOURCE TO THE DVR.....	3-4
3.7 LOOPING OUTPUTS.....	3-6
3.8 LOOPING OUTPUT TERMINATION.....	3-7
3.9 CONNECTING SENSORS TO THE DVR	3-7
3.10 CONNECTING CONTROL OUTPUTS TO THE DVR.....	3-8
3.11 ADDITIONAL OUTPUTS AND CONNECTORS.....	3-9
3.12 OPTIONAL COMPONENTS.....	3-10
SECTION 4 DVR BASICS	4-1
4.1 TURNING ON THE DVR.....	4-1
4.2 TURNING OFF THE DVR.....	4-1
4.3 DISPLAY SCREEN.....	4-2
4.4 CAMERA VIEW.....	4-4
4.5 RECORDING STATUS INDICATOR.....	4-4
4.6 SCREEN DIVISION MENU.....	4-5
4.7 TV OUTPUT CONTROLS (OPTIONAL).....	4-7
SECTION 5 SETUP OPTIONS.....	5-1
5.1 SETUP OVERVIEW.....	5-1
5.1.1 SETUP SCREEN OVERVIEW.....	5-1
5.2 CAMERA SETUP.....	5-2
5.3 MOTION.....	5-3
5.3.1 CREATING A MOTION AREA.....	5-4
5.3.2 REMOVING A MOTION AREA.....	5-4
5.3.3 REGULAR INTERVAL RECORDING.....	5-5

5.4	GENERAL SETUP	5-6
5.4.1	VOICE WARNING.....	5-7
5.4.2	INTENSIVE RECORDING OVERVIEW.....	5-8
5.4.3	HOW TO USE INTENSIVE RECORDING.....	5-9
5.4.4	VIDEO LOSS ALARM.....	5-9
5.4.5	AUDIO RECORDING.....	5-10
5.5	FRAME SETUP.....	5-11
5.6	RECORDING SCHEDULE	5-13
5.6.1	DAY OF THE WEEK.....	5-15
5.6.2	CREATING A SIMPLE SCHEDULE (BY EXAMPLE).....	5-15
5.6.3	SCHEDULING SENSORS AND RELAYS (BY EXAMPLE).....	5-19
5.6.4	VERIFYING A RECORDING SCHEDULE.....	5-23
5.7	SENSOR SETUP	5-24
5.8	NETWORK SETUP.....	5-25
5.9	ADMINISTRATION	5-27
5.9.1	USER MANAGEMENT.....	5-28
5.9.2	USER RANK	5-29
5.9.3	CHANGING THE ADMINISTRATOR PASSWORD.....	5-29
5.10	SITE INFORMATION.....	5-30
5.11	PTZ 5-31	
5.12	INSTANT RECORDING.....	5-31
5.13	ADJUSTING THE TIME, DATE, AND TIME ZONE.....	5-32
5.14	CENTRAL USER MANAGEMENT (OPTIONAL).....	5-33
5.14.1	SITE MANAGEMENT	5-35
5.14.2	USER MANAGEMENT	5-36
5.14.3	SELECT SITE	5-37
5.14.4	SETTING UP THE CENTRAL MANAGEMENT USER SERVER	5-37
5.14.5	ENABLING A DVR TO USE CENTRAL USER MANAGEMENT	5-38
5.15	TV OUTPUT CONTROL SETUP (OPTIONAL).....	5-38
5.15.1	CUSTOMIZING THE TV OUTPUTS.....	5-40

SECTION 6 SEARCH OPTIONS..... 6-1

6.1	SEARCH OVERVIEW.....	6-1
6.2	PLAY CONTROLS.....	6-3
6.3	HOUR / MINUTE SELECTOR	6-3
6.4	BRIGHTNESS / SPEED / ZOOM.....	6-4
6.4.1	ADJUSTING THE BRIGHTNESS OF AN IMAGE.....	6-4
6.4.2	ZOOMING IN ON AN IMAGE	6-4
6.4.3	ZOOMING IN ON A PORTION OF AN IMAGE.....	6-4
6.5	AFTER IMAGE REMOVAL.....	6-5
6.6	SEARCH OPTIONS OVERVIEW	6-6
6.7	PERFORMING A BASIC SEARCH	6-6

6.8	DAYLIGHT SAVINGS TIME	6-7
6.9	TIME SYNC.....	6-7
6.10	PRINTING AN IMAGE	6-8
6.11	'SAVE TO' FUNCTION	6-8
6.12	INDEX SEARCH	6-10
	6.12.1 PERFORMING AN INDEX SEARCH.....	6-10
6.13	PREVIEW SEARCH.....	6-12
	6.13.1 PERFORMING A PREVIEW SEARCH.....	6-13
6.14	OBJECT SEARCH	6-14
	6.14.1 PERFORMING AN OBJECT SEARCH	6-15
6.15	STATUS SEARCH.....	6-16
	6.15.1 PERFORMING A STATUS SEARCH	6-17
6.16	AUDIO	6-17
6.17	POINT OF SALE (OPTIONAL).....	6-18
SECTION 7 PAN / TILT / ZOOM		7-1
7.1	PAN / TILT / ZOOM OVERVIEW	7-1
7.2	SETTING UP A PTZ CAMERA.....	7-1
	7.2.1 SUPPORTED PROTOCOLS	7-3
7.3	ADVANCED PTZ SETUP	7-4
7.4	CREATING AND VIEWING PRESET POSITIONS	7-6
	7.4.1 CREATING A PRESET	7-6
	7.4.2 VIEWING A PRESET	7-7
7.5	UNDERSTANDING TOURS	7-7
	7.5.1 CREATING A PRESET TOUR.....	7-9
	7.5.2 VIEWING THE PRESET TOUR.....	7-9
	7.5.3 CREATING A PRESET TOUR2.....	7-9
	7.5.4 VIEWING THE PRESET TOUR2.....	7-9
	7.5.5 CREATING A MIMIC TOUR.....	7-10
	7.5.6 VIEWING THE MIMIC TOUR.....	7-10
7.6	PTZ STATUS ON CLOSE	7-11
	7.6.1 ACTIVATING THE PTZ STATUS ON CLOSE OPTION.....	7-11
7.7	PTZ ADDRESS SETTING	7-12
	7.7.1 ACTIVATING THE PTZ STATUS ON CLOSE OPTION.....	7-12
7.8	ACCESSING PTZ MENU's.....	7-13
	7.8.1 OPENING AND EDITING THE KD6 MENU.....	7-13
7.9	USING THE ON-SCREEN CONTROLLER AND COMPASS	7-14
	7.9.1 THE PTZ CONTROLLER.....	7-15
	7.9.2 AUX BUTTONS.....	7-16
SECTION 8 BACKING UP TO A CD-R DRIVE		8-1
8.1	BACKUP OVERVIEW	8-1

8.2	DirectCD FORMAT UTILITY	8-1
8.3	FORMATTING A CDR OR CD-RW DISC.....	8-3
8.4	GENERAL BACKUP OPTIONS OVERVIEW	8-3
8.5	SCHEDULED BACKUP OPTIONS OVERVIEW	8-6
8.6	SPECIFYING SCHEDULED BACKUP DRIVES.....	8-7
8.7	CREATING A SCHEDULED BACKUP	8-7
8.8	BACKING UP TO A CD-RW DRIVE OR HARD DRIVE	8-8
8.9	REMOVING THE DISC FROM THE CD-RW DRIVE	8-9
SECTION 9 LAN / ISDN / PSTN CONNECTIONS		9-1
9.1	<i>LAN OVERVIEW</i>	9-1
9.2	CONNECTING TO A LAN USING TCP/IP	9-1
9.2.1	CONFIGURING TCP/IP SETTINGS.....	9-1
9.2.2	CONNECTING THE DVR TO A LAN.....	9-2
SECTION 10 Digital Signature Verifier		10-1
10.1	DIGITAL VERIFIER.....	10-1
10.2	INSTALLING THE DIGITAL VERIFIER	10-1
10.3	USING THE Digital Verifier	10-2
SECTION 11 PROPRIETARY VIEWER		11-1
11.1	PROPRIETARY VIEWER OVERVIEW.....	11-1
11.2	INSTALLING THE PROPRIETARY VIEWER.....	11-2
11.3	LOADING VIDEO FROM CD-ROM OR HARD DRIVE	11-5
SECTION 12 ALARM MONITOR		12-1
12.1	ALARM MONITOR OVERVIEW	12-1
12.2	INSTALLING THE ALARM MONITOR	12-1
12.3	CONFIGURING THE DVR.....	12-2
12.4	CONFIGURING THE CLIENT PC	12-3
12.5	ALARM MONITOR WINDOW	12-4
12.5.1	EVENT LIST RIGHT CLICK.....	12-5
12.6	SEARCH ALARM WINDOW	12-6
12.7	CONFIGURATION WINDOW	12-7
SECTION 13 REMOTE SOFTWARE		13-1
13.1	FUSION REMOTE SOFTWARE OVERVIEW	13-1
13.1.1	REMOTE CLIENT MINIMUM REQUIREMENTS	13-2
13.1.2	REMOTE CLIENT RECOMMENDED REQUIREMENTS.....	13-2
13.2	SETTING UP THE SERVER TO ACCEPT INCOMING CONNECTIONS	13-3
13.2.1	CONFIGURING THE DVR SERVER TO ACCEPT REMOTE CONNECTIONS.....	13-3
13.3	SETTING UP THE FUSION REMOTE SOFTWARE.....	13-4
13.3.1	INSTALLING THE FUSION REMOTE SOFTWARE	13-4
13.3.2	CREATING A NEW REMOTE CONNECTION.....	13-4

SECTION 14 THE WEB VIEWER	14-1
14.1 WEB VIEWER OVERVIEW	14-1
14.1.1 CONFIGURING THE DVR SERVER TO ACCEPT REMOTE CONNECTIONS.....	14-2
14.1.2 CONNECTING TO A DVR WITH THE WEB VIEWER.....	14-2
14.1.3 CLOSING THE WEB VIEWER	14-3
SECTION 15 TECHNICAL SPECIFICATIONS	15-1
15.1 HFDVR FUSION 8-CHANNEL.....	15-1
15.2 HFDVR FUSION 16-CHANNEL.....	15-2
15.3 HFDVR FUSION 32-CHANNEL.....	15-3

NOTES:

SECTION 1 INTRODUCTION

1.1 PRODUCT DESCRIPTION

The Honeywell Fusion DVR is simply a server that performs as a High Definition Digital Recorder. By utilizing the many features of a computer, including processing power, storage capacity, graphics compression, and security features, the DVR unit is more powerful than the analog recorders of the past.

The Honeywell Fusion DVR server software comes pre-configured for fast and seamless integration within your existing IT infrastructure. Designed around Microsoft® Windows® 2000, the server software offers unparalleled stability, security, and ease of use. Accordingly, your security investment has never been easier to maintain. Multiple users may simultaneously connect through any network connection for instantaneous live viewing, digital search, and off site video storage. Users can also connect remotely through DSL, Cable Modems, ISDN, or 56K dial-up. This powerful software enables users to establish recording schedules, create motion detection zones, use PTZ controls, and configure alarm inputs and outputs for each of the system's cameras. With the latest advancements in the DVR Server Software, searching and indexing your video archive has never been easier. Video can now be found, viewed, and exported in a number of file formats with just a few clicks.

The Honeywell Fusion DVR is a high performance security product ready to meet today's security demands.

1.2 FEATURES

Honeywell's Fusion DVRs include the following features:

- Optimized and Designed for Microsoft® Windows 2000®.
- Supports up to 16 Digital Control Outputs on Alarm Activation
- Supports up to 16 Alarm Inputs for Alarm Control
- Remote System Operation & Configuration
- Supports Multiple Simultaneous Remote Connections
- Up to 4 Audio Inputs
- Pan / Tilt / Zoom Controls
- Simultaneous Video Search, Playback, and Backup
- Video Indexes for Easy Searching
- Multiple Levels of Security Access

1.2 FEATURES, CONTINUED

- Up to 32 Looping Outputs
- Optional POS and ATM Support
- 1 Composite Output
- S Video Output
- Up to 32 Camera Inputs
- High Performance, Durable, Rack mount Case
- Output the Video to a NTSC/PAL Display
- Virtually Unlimited Storage Potential
- Supports Digital Signatures
- Continuous Motion Detection, Alarm, Pre-Alarm, and Scheduled Recording Modes
- Hardware Watchdog
- 720x480 / 720x240 / 360x240 NTSC Recording Resolution
720x576 / 720x288 / 360x288 PAL Recording Resolution

SECTION 2 CONTROLS AND CONNECTIONS

2.1 BASIC FEATURES

Honeywell's state-of-the-art High Definition Digital Recorders are housed in a high performance and versatile 4U Aluminum Rack-Mount case allowing easy storage of multiple DVRs for enterprise applications. Every Fusion DVR Unit comes equipped with the latest technology

- Intel® Pentium® IV Processor
- 10/100 Network Interface Card (NIC)
- 256 MB of System Memory
- 32 MB Video Card
- CD-RW Recorder
- 3.5" Floppy Drive
- Full Duplex High-Fi Sound Functionality
- Standard 120 GB Video Storage Drive

2.2 FRONT PANEL CONTROLS AND LEDS

The front panel of the DVR unit contains the devices that will be commonly used for data removal, retrieval, and backup replacement. The most common components and buttons are shown below.

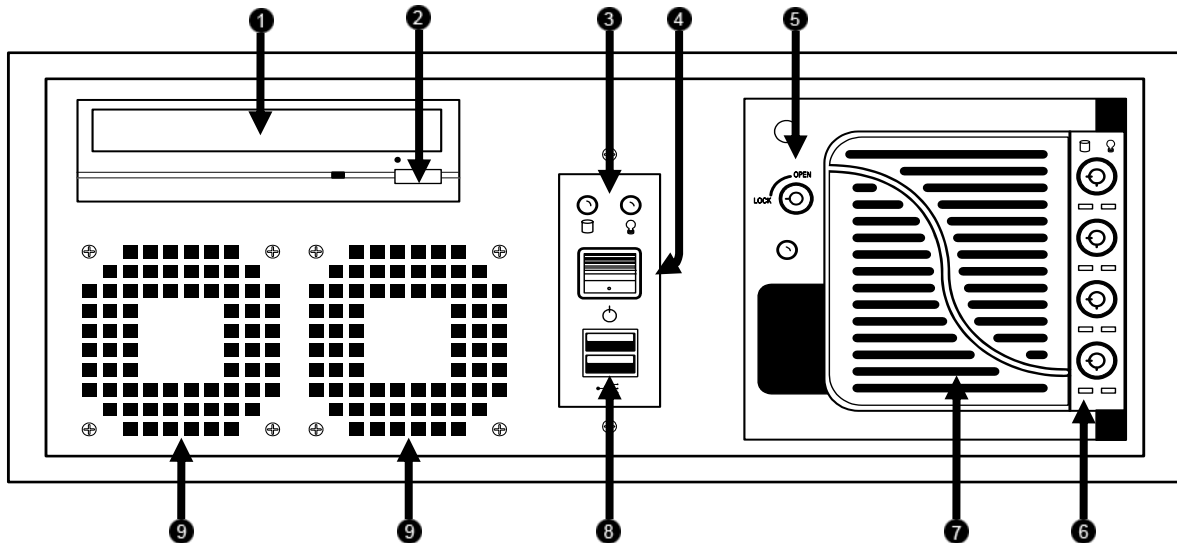

ID	Description
1	CD-RW Drive
2	CD-RW Open Tray Button
3	Hard Drive Activity LED Display
4	ON/OFF Power Switch
5	Hard Drive Bay Door Lock
6	Hard Drive Lock and Activity LED Display
7	Hard Drive Bay Door
8	USB Ports
9	Cooling Fan Air Intake

2.3 REAR PANEL CONNECTORS

The rear panel of the DVR unit contains virtually all of the connectors you will be using. Below is a diagram that outlines the location and description of each connector:

32 Channel

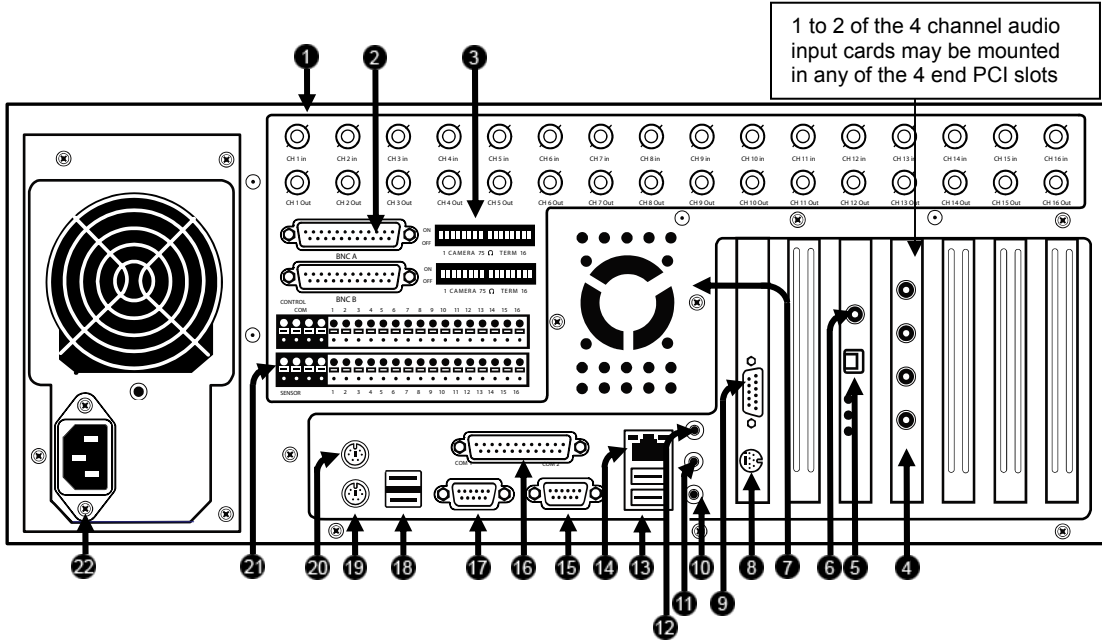

ID	Description	ID	Description
1	BNC Connectors for Video Input and Looping Outputs	12	Audio Line In
		13	USB Ports
2	BNC Expansion Ports	14	RJ-45 Network Jack
3	Termination Switches	15	DB-9 Serial Input 1
4	Audio Inputs	16	LPT Parallel Printer Port
5	RS-422 Interface	17	DB-9 Serial Input 2
6	RCA Video OUT	18	USB Ports
7	Exhaust Fan	19	PS/2 Keyboard Input
8	S-Video Output	20	PS/2 Mouse Input
9	DB-15 SVGA Monitor Output	21	Control Alarm Outputs / Sensor Inputs
10	Audio Microphone In	22	AC Power Connector
11	Audio Speaker Out		

connections displayed may not be available or functional on specific models.

8/16 Channel

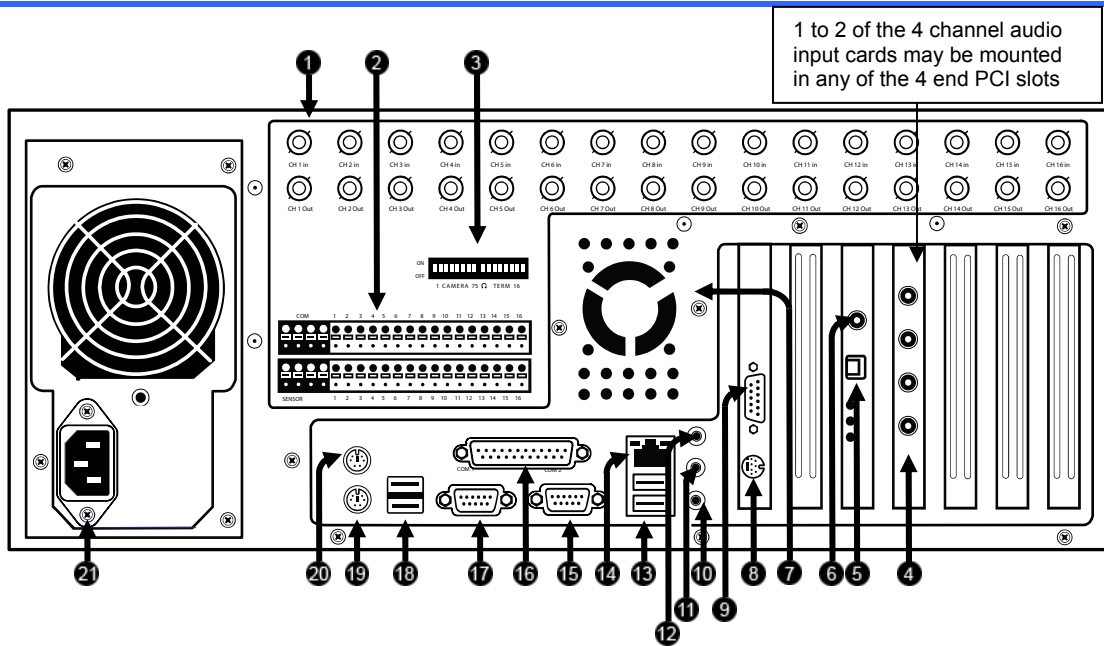

ID	Description	ID	Description
1	BNC Connectors for Video Input and Looping Outputs	12	Audio Line In
		13	USB Ports
2	Control Alarm Outputs / Sensor Inputs	14	RJ-45 Network Jack
3	Termination Switches	15	DB-9 Serial Input 1
4	Audio Inputs	16	LPT Parallel Printer Port
5	RS-422 Interface	17	DB-9 Serial Input 2
6	RCA Video OUT	18	USB Ports
7	Exhaust Fan	19	PS/2 Keyboard Input
8	S-Video Output	20	PS/2 Mouse Input
9	DB-15 SVGA Monitor Output	21	AC Power Connector
10	Audio Microphone In		
11	Audio Speaker Out		

SECTION 3 GETTING STARTED

3.1 IDENTIFYING INCLUDED COMPONENTS

Honeywell's Fusion DVRs come with a mouse, keyboard and selected software and cables. Identify the following components to make sure everything has been properly included with your new DVR unit. If any of the following items are missing, contact your dealer to arrange a replacement.

Included Component List

1. DVR Unit (image may vary depending on model)
2. Mouse
3. Keyboard
4. DVR Repair and Software Disc
5. RCA Video Adapter (1x in 16 channel, 2x in 32 channel)
6. Power Cord
7. PTZ Adapter
8. Rack mount Attachments with 4 tapered mounting Screws
9. DVR Key
10. DVR Manual
11. Mouse Pad
12. Hard Drive Key

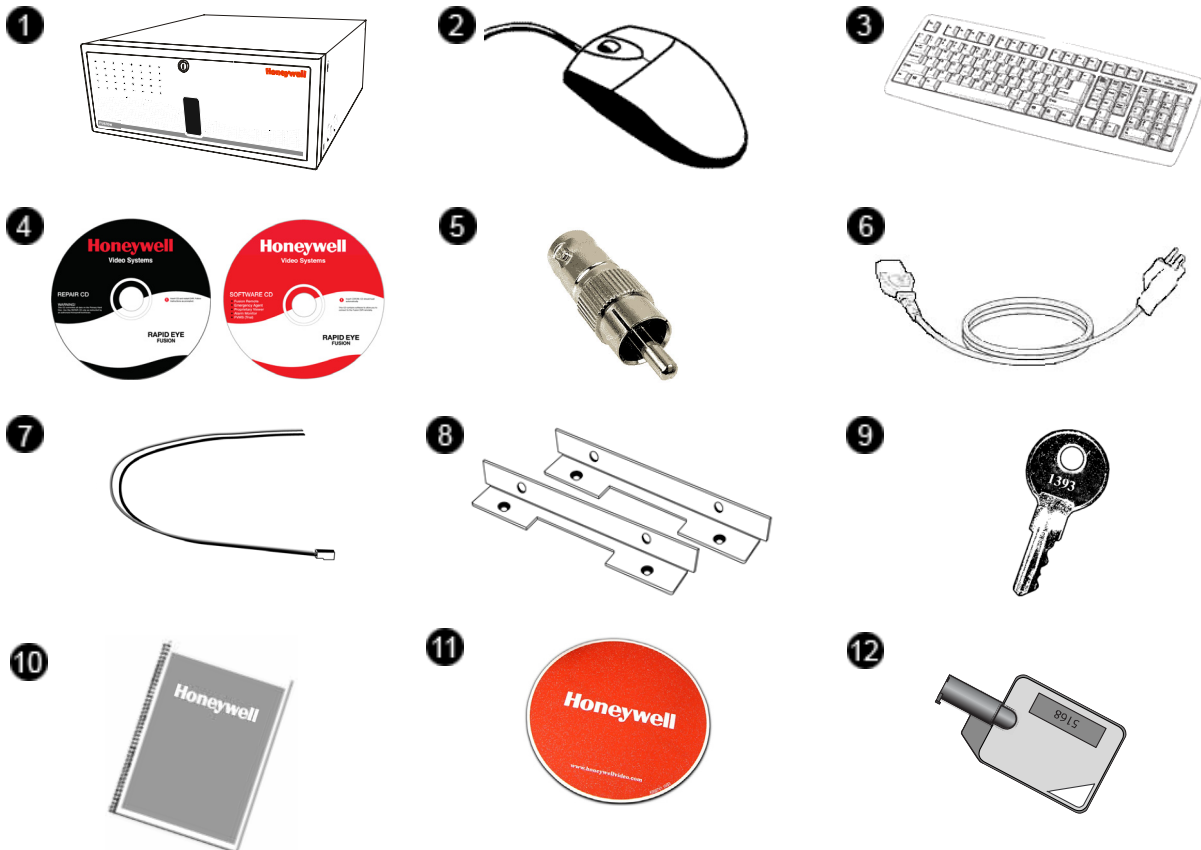

3.2 KEYBOARD SETUP

To attach the keyboard to the DVR unit, plug the end of the Keyboard cable into the keyboard PS/2 Port located on the back of the machine. The keyboard PS/2 Port can be identified by the purple color. Refer to Section 2.3 – Rear Panel Connectors for more information.



3.3 MOUSE SETUP

To attach the mouse to the DVR unit, plug the end of the mouse cable into the mouse PS/2 Port located on the back of the machine. The mouse PS/2 Port can be identified by the green color. Refer to the Section 2.3 – Rear Panel Connectors for more information.

The mouse uses a cursor called a pointer. Pointers come in many different shapes but are most commonly shaped like an arrow.

The mouse has two buttons: a left button and a right button. Quickly pressing and releasing one of these buttons is called clicking. Sometimes it will be necessary to double-click – or click the same button twice quickly.

In this manual, click means to position the mouse point on an icon and to single click the left button. When a right click is required, this is stated clearly. Double-click also refers to the left button.

The ratchet wheel in between the two buttons is added to provide easier scrolling capability. By simply moving the wheel with your index finger, you can quickly move through multiple pages, lines, or windows. The wheel may also function as a third button allowing you to quickly click or double-click an icon or a selected item.

ID	Description
1	Left Button
2	Scroll Button/Third Button
3	Right Button

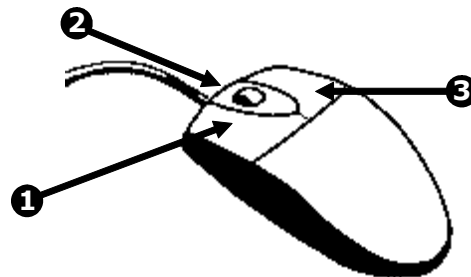

3.4 MONITOR SETUP

Attach the Monitor to the Rear of the DVR unit using the VGA cable supplied by the Monitor Manufacturer. Refer to the monitor manual for detailed information on how to setup and use it.

NOTE: The monitor you use must be capable of having a screen resolution of 1024 x 768 and display colors of at least 32 Bit.

3.5 POWER SETUP

Attach the AC power cable to the rear of the DVR Unit.
See Section 2.3 – Rear Panel Connectors for more information.



WARNING:

To reduce the risk of electrical shock or damage to the equipment:

- Do not disable the power grounding plug.
The grounding plug is an important safety feature.
- If the electrical plug you are using does not have a ground plug receptacle contact a licensed electrician to have it replaced with a grounded electrical outlet.
- Plug the power cord into a grounded (earthed) electrical outlet that is easily accessible at all times.
- Disconnect the power from the computer by unplugging the power cord either from the electrical outlet or the computer.

3.6 CONNECTING A VIDEO SOURCE TO THE DVR

There are different types of Video Sources that can be plugged into your DVR unit including DVD players, VHS players, and CCTV Cameras. The back of the DVR unit contains up to 32 video inputs depending on the DVR model. The connectors are standard BNC connectors.

8-Channel DVR

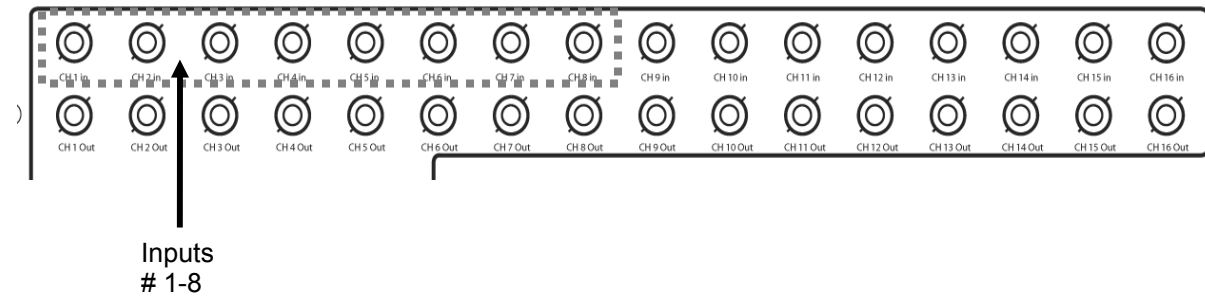

The Video inputs are BNC connectors. Simply plug one end of the BNC-BNC cable into your video source (DVD, Camera, etc.) and plug the other end into the desired BNC input on the DVR unit.

3.6 CONNECTING A VIDEO SOURCE TO THE DVR, CONTINUED

16 Channel DVR

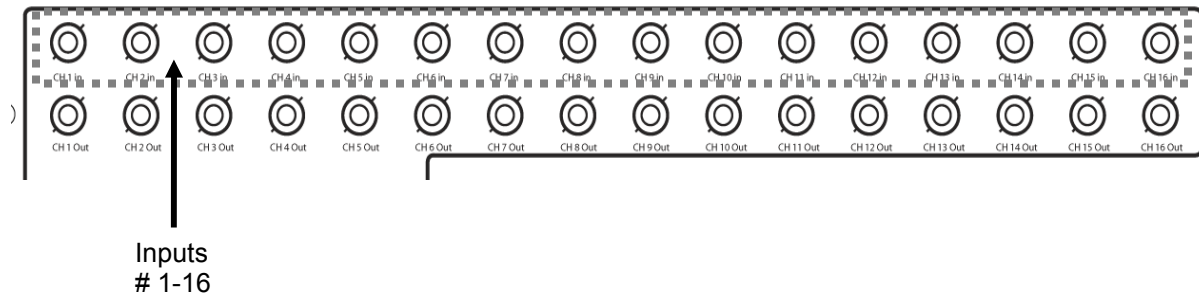

32 Channel DVR

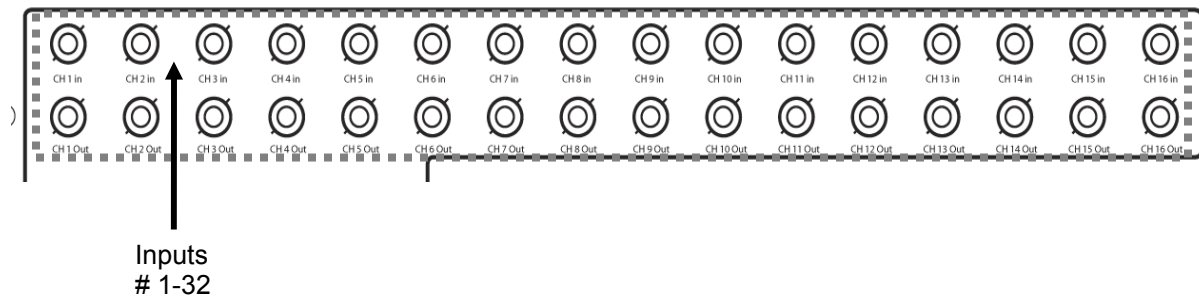

3.7 LOOPING OUTPUTS

The 8 and 16 Channel DVR units may have up to 16 Looping outputs. Depending on the destination of the outputs, each output may have to be terminated.

8 Channel DVR

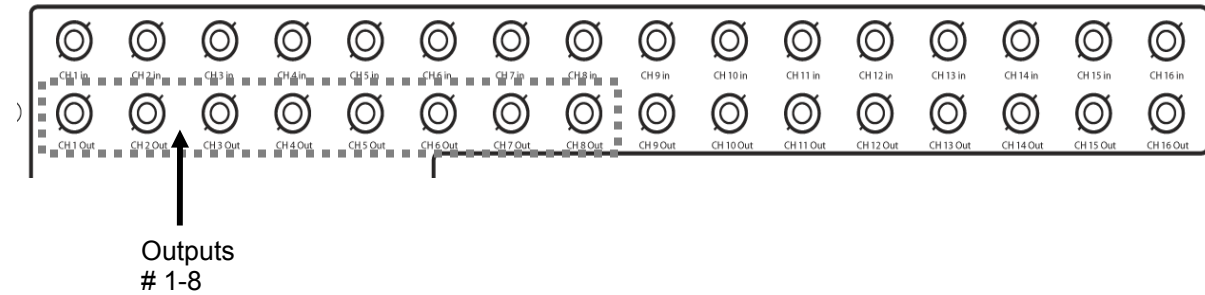

16 Channel DVR

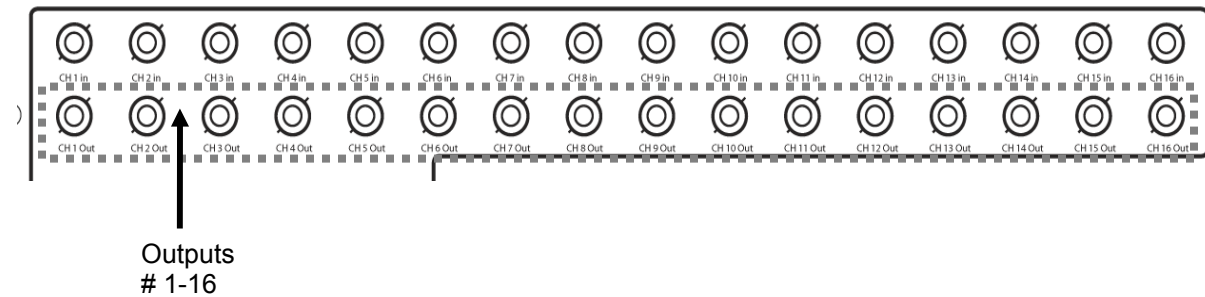

The Video inputs are BNC connectors. Make sure there is a video source connected to the input and then connect a cable to the Channel Out. The looping outputs can be connected to video monitors or VCR's. Consumer VCR's that use RCA connectors may require a BNC-RCA adapter.

3.8 LOOPING OUTPUT TERMINATION

When terminating the outputs becomes necessary, the DVR unit has built-in termination that allows you to select individual outputs to be terminated. Generally it is not necessary to terminate the output when using it. It is dependant on if the device to which you are connecting it, has internal 75 ohm termination. As a rule, if the image appears distorted or virtually unviewable, it most likely needs to be terminated.

Terminating the Looping Outputs

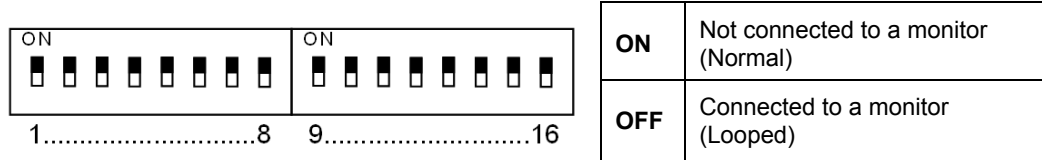

Always leave the dipswitch set to the ON position when the Looping Outputs are not used.

3.9 CONNECTING SENSORS TO THE DVR

Each DVR unit may have up to 16 Sensor inputs. These inputs can be used with devices such as Infrared sensors, motion devices, glass break alarms, door and window trips, and many more. The Sensors inputs can be set to Normally Open or Normally Closed inside the software.

There are 4 Commons (-) and 16 inputs (+). There is no power supplied to the ports so an external power supply must be used if power becomes necessary.

Sensor Connections

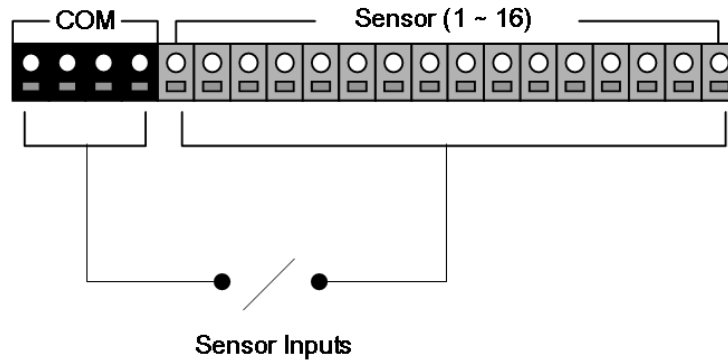

- Normally Open or Normally Closed option is available inside the DVR Software.
- There is no power supplied to the ports. These ports are considered to be “Dry Contacts”. Use an external power supply if necessary.

3.10 CONNECTING CONTROL OUTPUTS TO THE DVR

Each DVR unit may have up to 16 Control Outputs. These outputs can be used to trigger devices such as Sirens, Phone Dialers, Lights, and any other relay activated device.

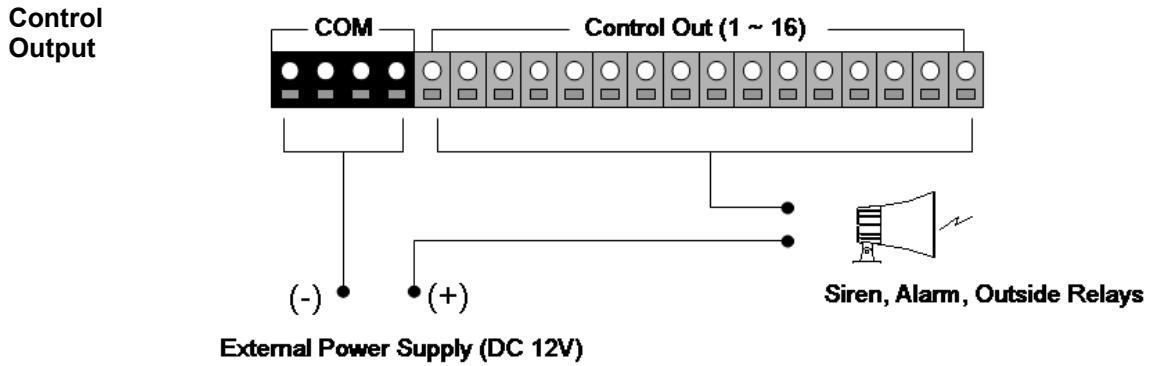

- Use 12V, below 300mA. For controlling lights or other high current devices, use an external relay.
- Maximum voltage is 24V AC @ 1 amp
- Output uses a Form C Relay (NC-C-NC)

3.11 ADDITIONAL OUTPUTS AND CONNECTORS

240/480 FPS

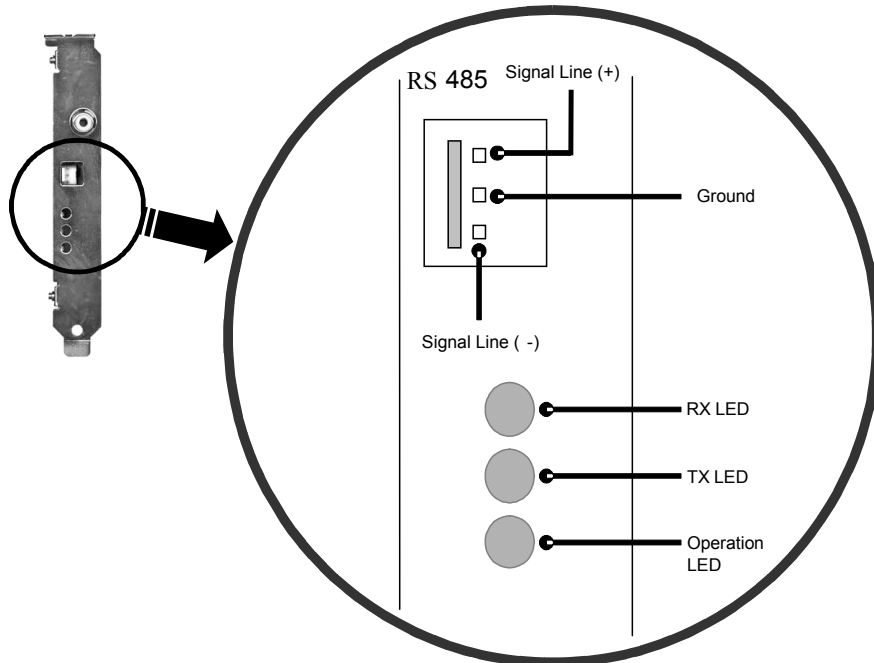

120 FPS

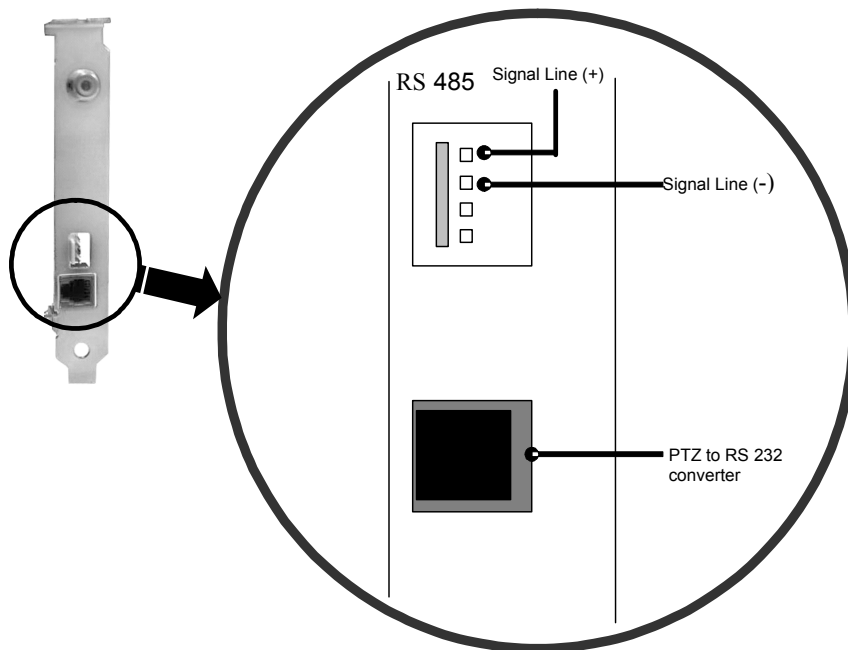

3.12 OPTIONAL COMPONENTS

To fully utilize your DVR unit's potential, several optional Fusion components are listed below. Contact your dealer for more information.

DVD ROM Recordable Drive	SCSI Adaptor
USB External Hard Drive	USB Modem
Fiber Network Interface Adapter	4 Port Analog Output Card
Gigabit 10/100/1000 NIC Adapter	16 Port Audio Card
Fusion Remote Video Software	External IDE Storage 1 Terabyte
Internal Raid One	Internal Raid Five
Stand Alone CYA Software	CYA Client Software
Network Accessible Version of CYA	Stand Alone CYA for ATM
CYA - ATM Client Software	Network Accessible ATM Version
Fusion Video Management Software	

SECTION 4 DVR BASICS

4.1 TURNING ON THE DVR

Once the cables have been properly connected (see Chapter 2 – Controls and Connections), it is time to turn on the power.

1. Turn on the monitor and any external peripherals (ex. Printers, External Storage Devices, etc.) connected to the DVR unit.
2. Turn on the main power switch located on the front of the DVR unit as shown below. (See Section 2.2 – Front Panel Controls for location of the main power switch.)

The DVR will run a series of self-tests. After two or three minutes, a series of messages may be displayed as the various hardware and software subsystems are activated. Under normal circumstances you should not be asked to respond to these messages. If you are asked to respond to the messages (adding a Printer, Monitor, etc., for the first time) follow the instructions carefully.

4.2 TURNING OFF THE DVR

1. Select the **Exit** button from the main screen. (Refer to Section 4.3 – Display Screen for location of Exit button.) This will prompt you whether you wish to exit the program or not.
2. Select **Yes**. The DVR unit will shut itself off automatically once this is done. The DVR unit may take several minutes to shut down completely



CAUTION: Always be sure to follow the proper procedures when turning off the power to the DVR unit. NEVER disconnect the power to the DVR unit while it is still running or in the process of shutting down. Doing so can cause data loss, file corruption, system instability and hardware failure.

4.3 DISPLAY SCREEN

Each time the DVR is restarted, the program defaults to the Display screen. The following diagram outlines the buttons and features used on the Display screen. Become familiar with these options as this is the screen that will be displayed the majority of the time.

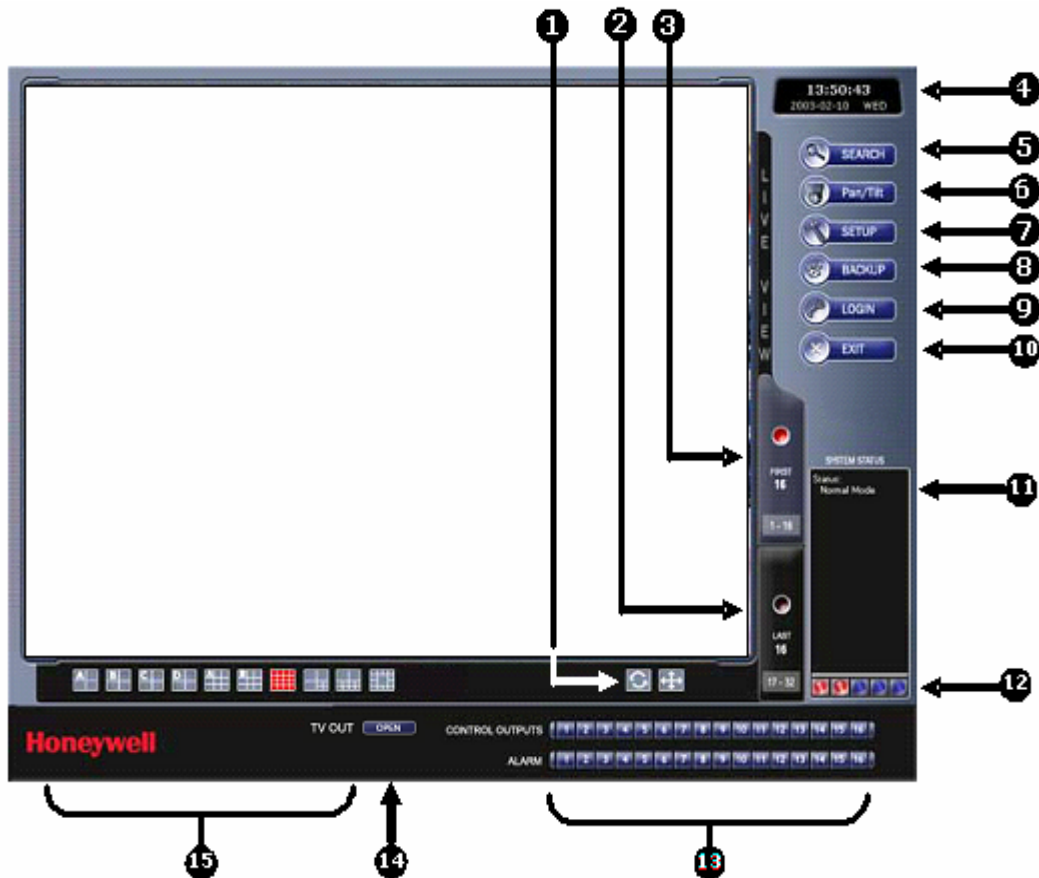

1	Loop/Full Screen	<p>Pressing the Loop button sequences through the Screen Divisions sets. For Example, selecting the 1A and then the Loop button will sequence through 1A,2A,3A,4A and then repeat. This option is not available for the 7,10 and 13 screen divisions.</p> <p>The Full Screen option allows viewing of the Video Display Area using the entire viewable area on the monitor. When this is selected, no menu options are visible. The Full Screen Option is activated by clicking on the Full Screen Button within the Screen Division Menu. Deactivate the Full Screen mode by right clicking on the screen.</p>
---	-------------------------	---

4.3 DISPLAY SCREEN, CONTINUED

2	Second 16	Displays the second set of 16 cameras (Only available on the 32 Channel unit)
3	First 16	Displays the first set of 16 cameras (Only available on the 32 Channel unit)
4	Date/Time	Displays current date and time. This date and time is stamped onto the recorded video and is displayed whenever the video is played back.
5	Search	Displays search features that allow for searching through previously recorded video.
6	PTZ	Opens Pan/Tilt options for controlling PTZ-enabled cameras.
7	Setup	Displays Setup menu, from which all customizable settings can be edited.
8	Backup	Displays the Backup option
9	Login	Allows you to login as a different user.
10	Exit	Displays several options, including Shut Down, Restart, and Restart in Windows Mode.
11	Current User	Displays the name of the user currently logged onto the DVR.
12	Remote Client Status	Displays users connected remotely to the DVR unit.
13	Alarm Status Bar	Displays Alarm Status for each Sensor Input.
	Control Output Status and Activation Bar	The Digital Output Relay button fires the Output Relay. The output relays can be hooked up to external alarms, set to trigger a phone call, etc.
14	TV OUT	Optional controls for the analog switched outputs.
15	Screen Division Buttons	Allows the view of one or more sets of cameras at a time. They are organized in several different groups such as 2x2, 3x3, and 4x4.

4.4 CAMERA VIEW

The Camera status for each camera is displayed next to the Camera number (or name) on the Video Display Area.

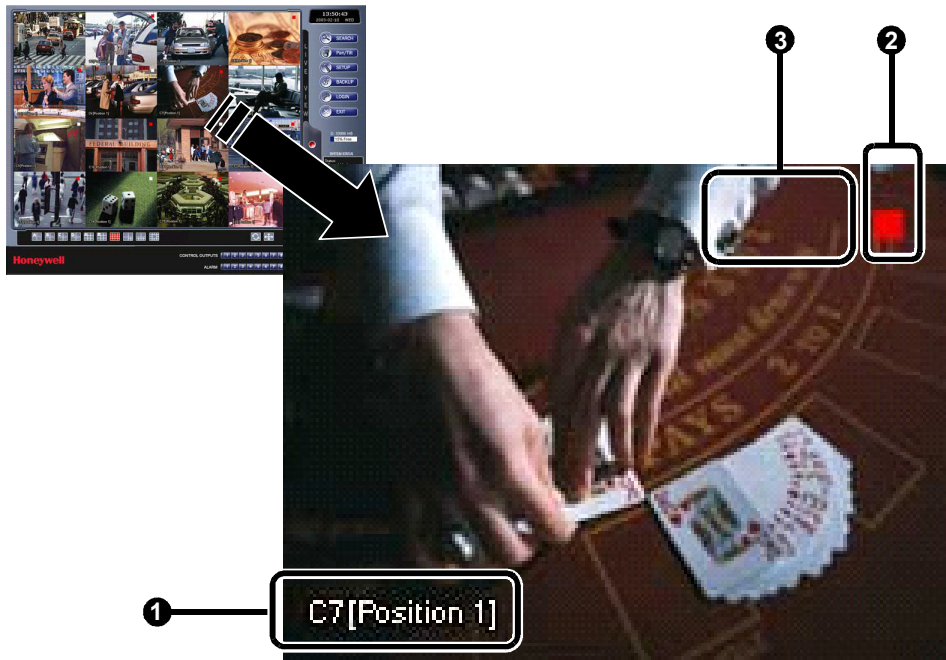

1	Camera Number and Name	Displays the camera number and the custom name given to the camera.
2	Recording Status	Displays the current recording status of the camera using symbols. (See Section 4.5 – Recording Status Indicators).
3	Special Recording	Displays text relating to the type of recording that is occurring. (See Section 4.5 – Recording Status Indicators).

4.5 RECORDING STATUS INDICATOR

	Recording	A red light is displayed when the camera is currently being recorded to the DVR unit.
	Motion Detection	A green light is displayed when a camera (set up for motion detection) detects motion
	Display	A square is displayed when the camera is currently not being recorded to the DVR unit.



Special Recording

There are several different types of DVR “Special Recording” situations. When this happens, text is displayed on the camera indicating what kind it is.









Sensor	Displays when a sensor, associated with a given camera, is activated.
Instant	Instant Recording is a manual activation of the recording for the selected camera. Regardless of the recording method, Instant Recording will start the camera recording and also flag the video for future searches using the Index Search feature. INSTANT is displayed when a user activates the instant recording option. Double Right-Click to activate and deactivate the Instant Recording option.

4.6 SCREEN DIVISION MENU

The Screen Division menu allows you to view cameras full screen by rotating 1x1, 4x4, 8x8, or by viewing 4, 8, or 16 at a time. The button options are shown below.

	1st Four Cameras	Displays cameras 1-4 in the Video Display Area. To return to a different Multi-Camera View, select a different Screen Division option from the Screen Division menu.
	2nd Four Cameras	Displays cameras 5-8 in the Video Display Area. To return to a different Multi-Camera View, select a different Screen Division option from the Screen Division menu.
	3rd Four Cameras	Displays cameras 9-12 in the Video Display Area. To return to a different Multi-Camera View, select a different Screen Division option from the Screen Division menu.

4.6 SCREEN DIVISION MENU, CONTINUED

	4th Four Cameras	Displays cameras 13-16 in the Video Display Area. To return to a different Multi-Camera View, select a different Screen Division option from the Screen Division menu.
	1st Eight Cameras	Displays cameras 1-9 in the Video Display Area. To return to a different Multi-Camera View, select a different Screen Division option from the Screen Division menu.
	2nd Eight Cameras	Displays cameras 10-16, 8, and 9 in the Video Display Area. To return to a different Multi-Camera View, select a different Screen Division option from the Screen Division menu.
	Multi-Camera View	Displays a group of cameras within the Video Display Area
	All Camera View	Displays all 16 cameras within the Video Display Area.
	Multi-Camera View	Displays a group of cameras within the Video display Area.
	Multi-Camera View	Displays a group of cameras within the Video display Area.
	Full Screen	The Full Screen Option allows the Video Display Area to use the entire viewable area on the monitor. When this is selected, no menu options are visible. Activate the Full Screen Option by clicking on the Full Screen Button within the Screen Division Menu. Deactivate Full Screen mode by right clicking on the screen.
	AUTO-SEQUENCE	Sequences through the Screen Divisions sets. For example, selecting the 1A and then the Loop button will sequence through 1A,2A,3A,4A and then repeat. This option is not available for the 7,10 and 13 screen divisions.

4.7 TV OUTPUT CONTROLS (OPTIONAL)

The TV OUT options allows manual control the 4 analog outputs on the back of the DVR. Within setup the outputs can be programmed to sequence through any number of cameras, however, by using the TV OUT options that defined sequence can be temporarily stopped and a camera can be manually selected to output. The sequence can be easily reactivated by simply enabling the sequence again.

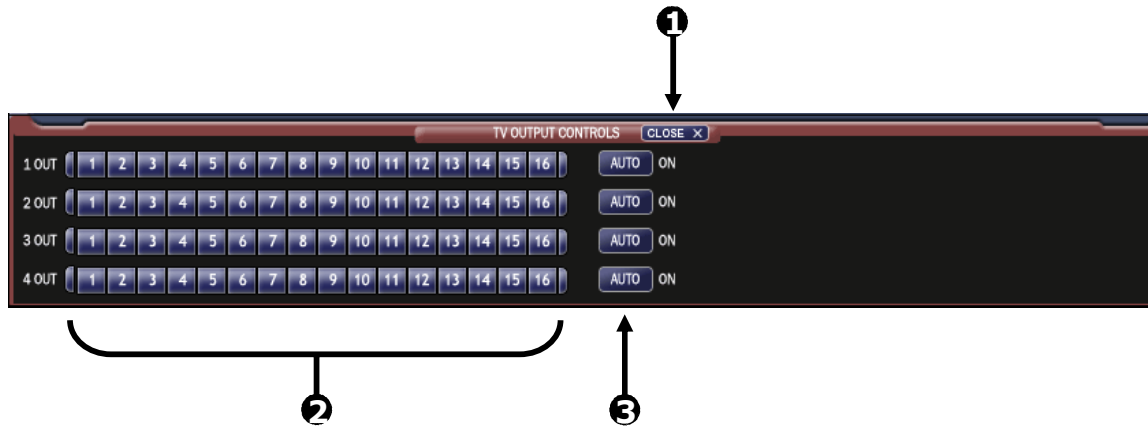

1	Close	Closes the TV Output Controls
2	Camera Select	Selects a camera to output on the selected channel.
3	AUTO On/Off	Re-enables the Auto-Sequence for the selected channel (as defined inside setup).

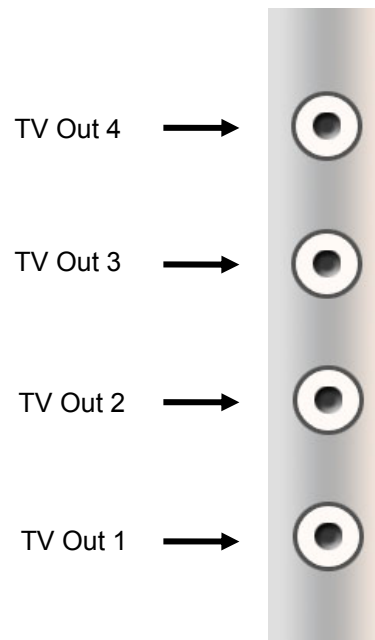

NOTES:

SECTION 5 SETUP OPTIONS

5.1 SETUP OVERVIEW

The Setup options allow optimization your DVR unit by adjusting things like camera names, recording schedules and more. It is extremely important to setup your DVR correctly for several reasons:

- **Recording Schedules** – Increase the amount of pertinent recorded video that is saved on the DVR by optimizing the recording schedule. Optimize the type of recording done by adding motion detection to this as well, again increasing the amount of useful video.
- **DVR Access** – By setting up the access passwords better control of the types of access any individual may have. This ensures the security and integrity of the DVR.
- **Camera Naming** – By naming each camera the location can be easily identify and any other pertinent information that may be helpful simply by viewing it on the Video Display Area.
- **Adjusting Camera Color** – Optimize the clarity and detail that is recorded by adjusting each camera's color settings.

5.1.1 SETUP SCREEN OVERVIEW

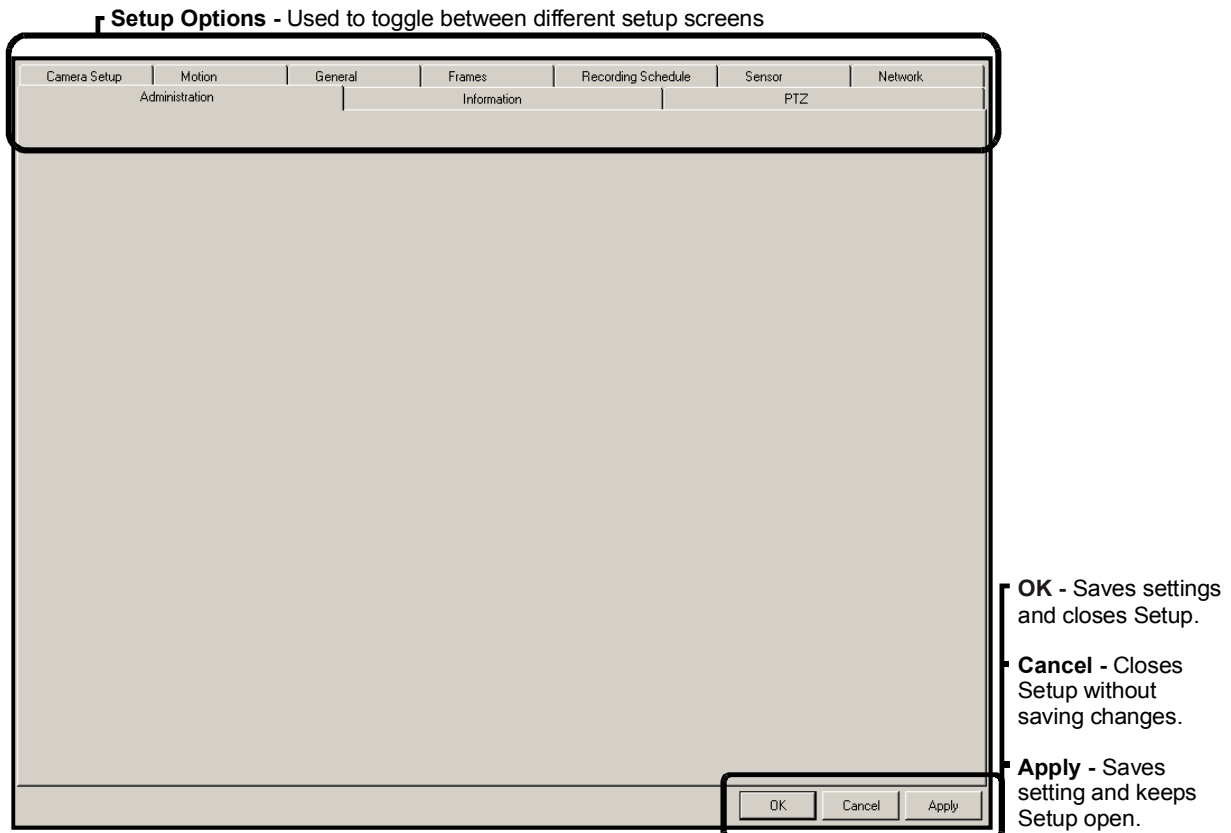

5.2 CAMERA SETUP

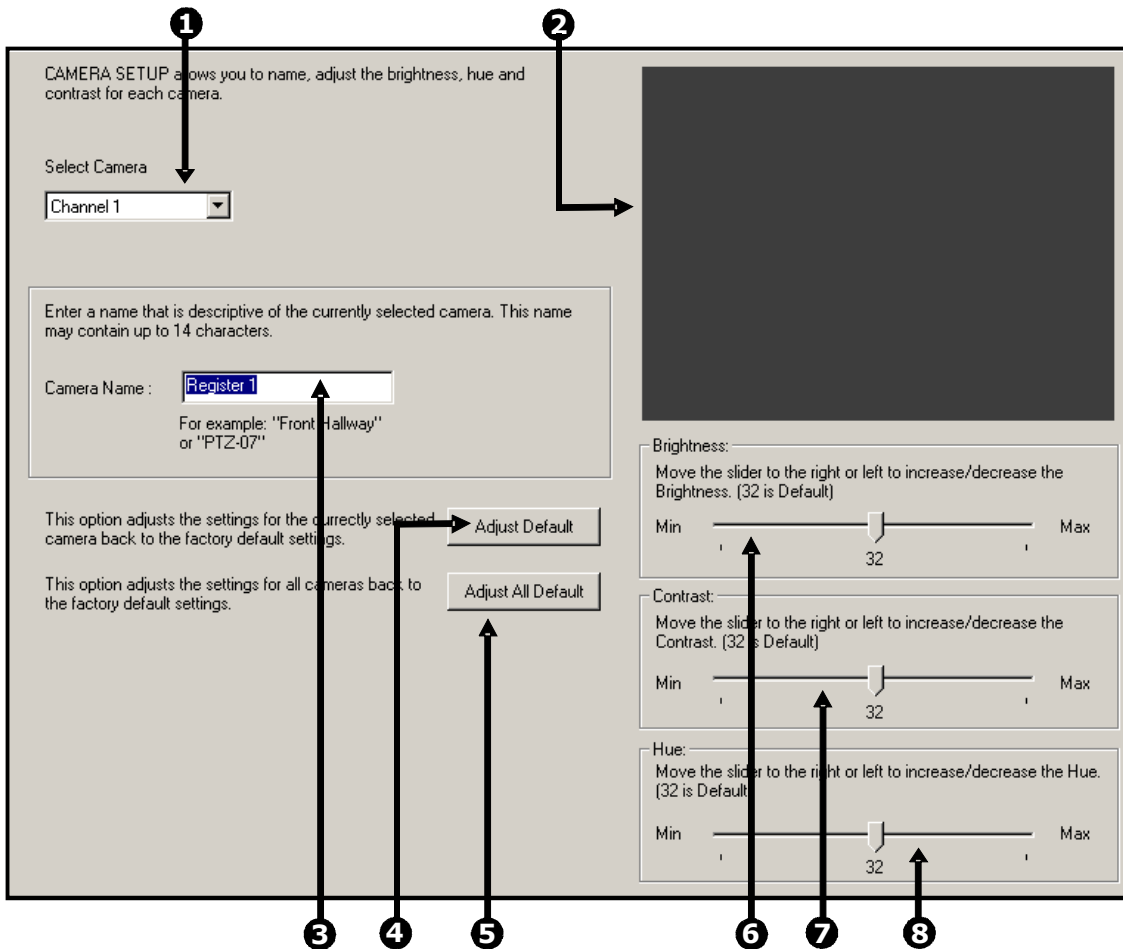

1	Select Camera	Selects the current camera to be edited.
2	Video Display	Displays the live video of the current camera selected.
3	Camera Name	Ability to specify a name for each camera. (up to 14 characters for every camera)
4	Adjust Default	Adjusts the color settings for the selected camera back to the system default.
5	Adjust All Default	Adjusts the color settings for ALL cameras to the system default.
6	Bright	Adjusts the brightness of the selected camera.
7	Contrast	Adjusts the contrast of the selected camera.
8	Hue	Adjusts the hue of the selected camera.

5.3 MOTION

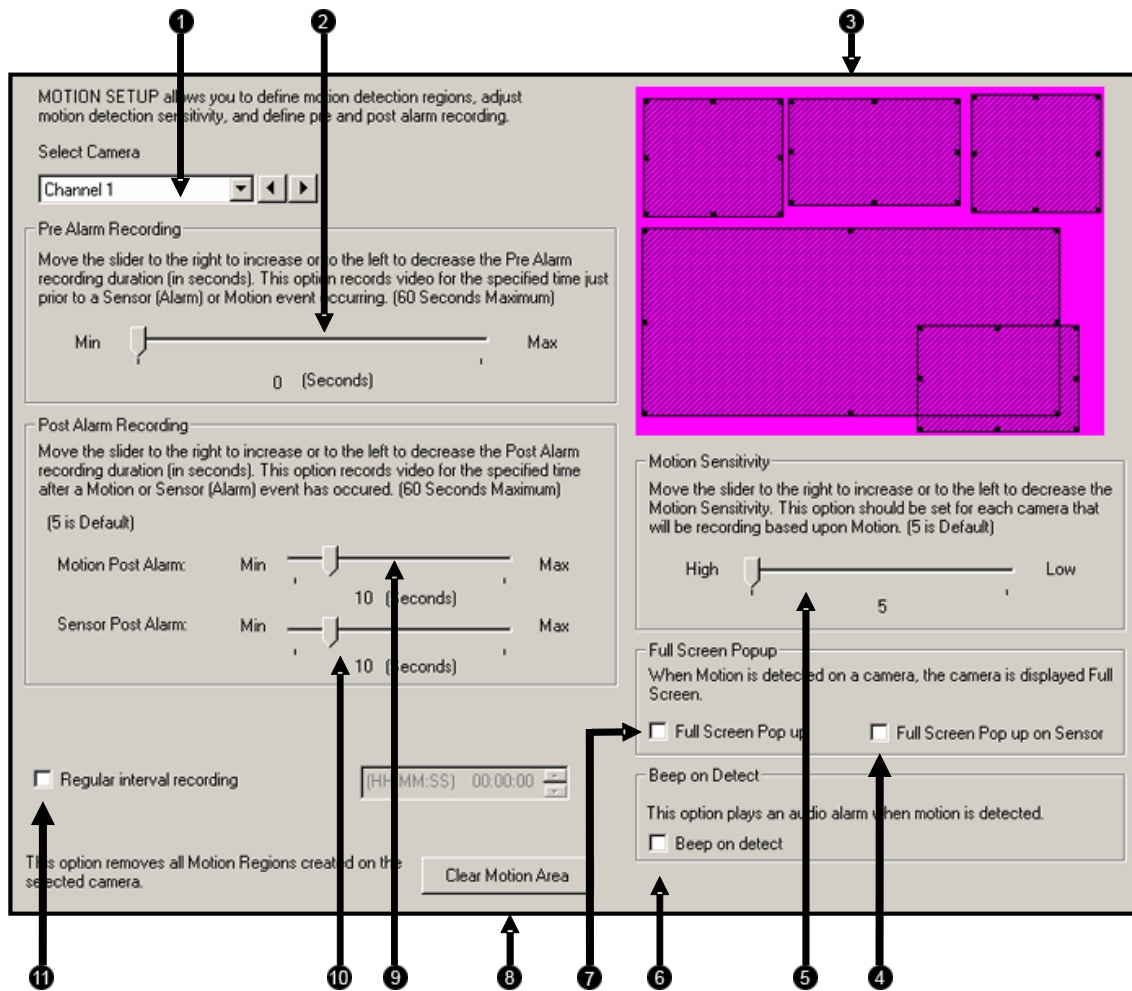

1	Select Camera	Selects the current camera to be edited.
2	Pre-Alarm	Allows record of a section of video just prior to motion or sensor activation.
3	Motion Region Setup	The box displays the video for the selected cameras and allows you to create up to 5 motion regions.
4	Full Screen Pop-Up on Sensor	When a sensor is activated, the camera is displayed full screen.
5	Sensitivity	Adjusts the sensitivity within the designated motion areas.

5.3 MOTION, CONTINUED

- | | | |
|----|-----------------------------------|--|
| 6 | Beep on Detect | When motion is detected, an internal speaker on the DVR sounds an alarm. |
| 7 | Full Screen Pop-Up | When motion is detected, the camera is displayed full screen. |
| 8 | Clear | Clears all motion areas for the selected camera. |
| 9 | Post Alarm (MOTION) | Record video after motion has stopped for a specified period of time. This option will only work for camera set to record using motion detection. |
| 10 | Post Alarm (SENSOR) | Record video after a sensor event has ceased for a specific period of time. This option will only work for cameras set to record from a sensor. |
| 11 | Regular Interval Recording | This option allows you to record a single frame every few minutes or every few hours to show that the DVR is still functioning even when motion is not taking place. This option only works when Motion recording or Sensor recording is selected. |

5.3.1 CREATING A MOTION AREA

1. Place the mouse pointer at the upper left hand corner of the designated area, press and hold down the left mouse button, drag the mouse. Let go of the button when the Motion Area is of the desired size.
2. Continue creating as many Motion Areas as desired (up to 5). Resize and move motion areas by dragging the sides and corners of the Motion Area window.



5.3.2 REMOVING A MOTION AREA

To remove the motion areas, press .

5.3 MOTION, CONTINUED

5.3.3 REGULAR INTERVAL RECORDING

Motion To enable regular Interval Recording on Motion follow these steps:

1. Setup a camera to record on motion.
2. Place a check in the Regular Interval Recording box.
3. Specify how often to take an image when no motion is occurring. You can go as little as 1 image per second.

Sensor To enable regular Interval Recording on a Sensor Event follow these steps:

1. Setup a camera to record on motion.
2. Delete the motion grid on the selected camera. This will cause the camera to never be triggered by a Motion event.
3. Associate a Sensor to the selected camera, and set the schedule . Sensor Recording supersedes all other types of recording. When a sensor event occurs, the camera will begin recording.
4. Place a check in the Regular Interval Recording box.
5. Specify how often to take an image when no motion is occurring. You can go as little as 1 image per second.

5.4 GENERAL SETUP

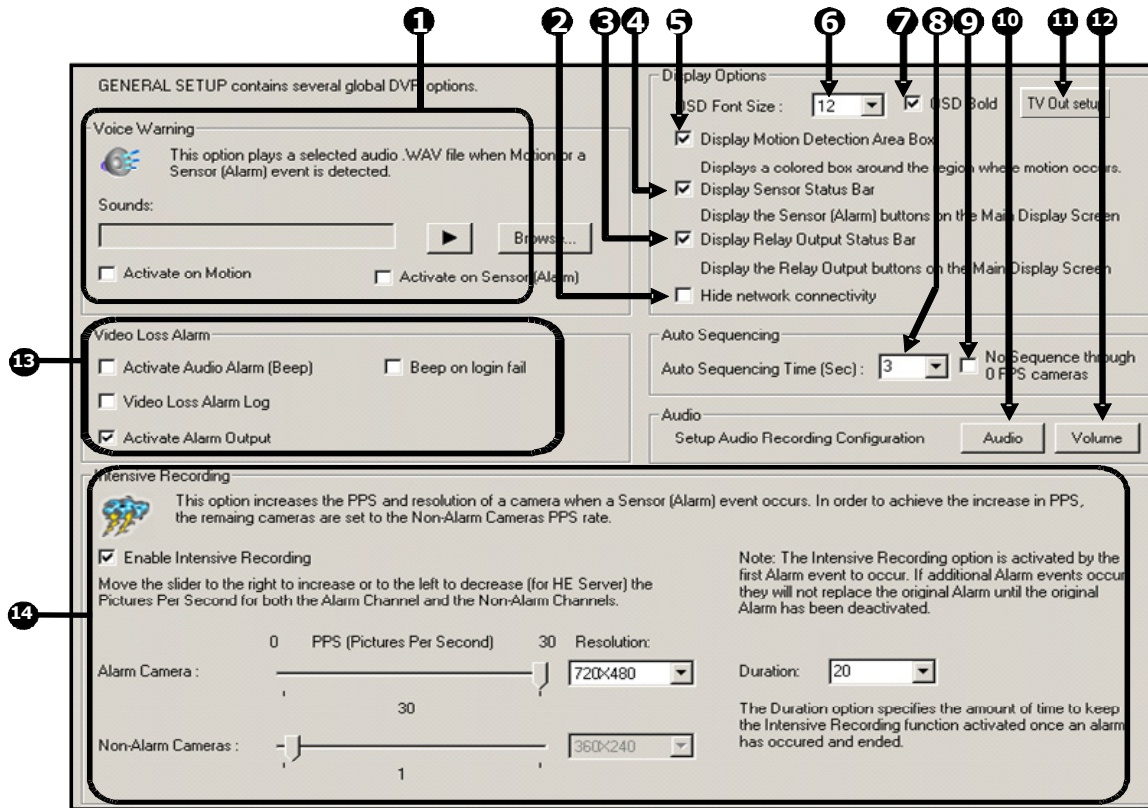

1	Voice Warning	Provides an audible warning (.wav sound clip) when motion or sensors are activated.
2	Hide Network Connectivity	Enables/Disables display of the Network Connectivity on the Main Display Screen.
3	Display Relay Output Status Bar	Enables/Disables display of the Relay Output Status Bar on the Main Display Screen.
4	Display Sensor Status Bar	Enables/Disables display of the Alarm Status Bar on the Main Display Screen
5	Display Motion Detection Area Box	Displays the motion area box on the Main Screen whenever motion occurs.
6	OSD Font Size	Allows adjustment of the On-Screen Display font size for cameras.
7	OSD Bold	Makes OSD Font bold.

5.4 GENERAL SETUP, CONTINUED

8	Auto Sequencing Time (sec)	When the Loop button is activated, the Auto Sequencing Time specifies the amount of time that elapses before switching to the next Screen Division group.
9	No Sequencing on 0 FPS	Does not sequence through cameras that have 0 FPS specified.
10	Audio	Opens the Audio enable/disable options.
11	TV Out Setup	Opens the TV Out setup options.
12	Volume	Opens the Volume controls that affect the Audio Recording levels.
13	Video Loss Alarm	These options allow video loss to be designated as an alarm.
14	Intensive Recording	Opens the Intensive Recording window which allows you to specify the Pictures per second to be recorded.

5.4.1 VOICE WARNING

The DVR unit can be set to play a sound file when either a Motion or Sensor event occurs. This file can be a custom created sound file that is unique to your application. The selected WAV file is played through speakers attached to the DVR unit.

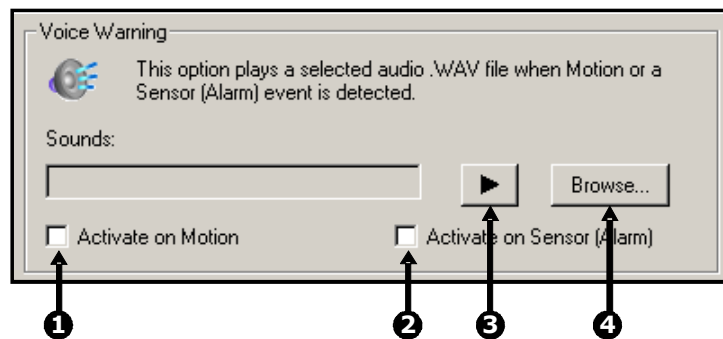

1	Activate on Motion	Enables the voice warning on motion events.
2	Sensor Event	Enables the voice warning on sensor events.
3	Play Selected WAV	Plays the selected WAV file.
4	Browse	Used to select the location of the WAV file to use.

5.4 GENERAL SETUP, CONTINUED

5.4.2 INTENSIVE RECORDING OVERVIEW

The Intensive Recording Option allows increasing of the Pictures Per Second and the resolution of any camera recording using sensor activation. When the intensive recording is activated, the resolution of the remaining cameras is immediately reduced to 360x240 and the Pictures per second to a user specified level. This is done to guarantee that the Pictures Per Second and Resolution will be set correctly and not exceed the DVR limitation.

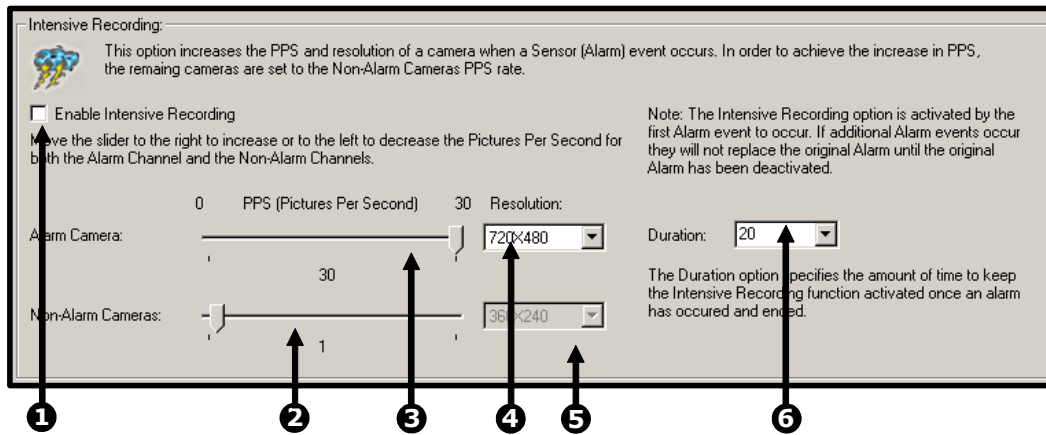

1	Enable Intensive Recording	Enables the association of intensive recording to sensors.
2	Non-Intensive Channel	Adjusts the frame rates for the non-intensive channels. The channels will drop their current settings and be forced to use this setting.
3	Intensive Channel	Adjusts the frame rate for the intensive channel.
4	Intensive Channel Resolution	Adjusts the resolution for the intensive channel.
5	Non-Intensive Channel Resolution	The DVR automatically adjusts the non-intensive channels down to the system default. This setting cannot be changed.
6	Holding Duration	Adjusts the amount of time to hold the intensive recording active.

5.4 GENERAL SETUP, CONTINUED

5.4.3 HOW TO USE INTENSIVE RECORDING

The Intensive Recording option is set up as an 'All or Nothing'. This means that once enabled (associated with sensors), all cameras that are associated with sensors will activate the Intensive Recording.

Activating Intensive Recording

To activate the Intensive Recording option, follow these steps.

1. Inside **Setup**, select the desired camera to use and then enable the appropriate sensor associated to it.
2. Open the **Intensive Recording** Options. Enable the **Intensive-On-Sensor** option and then select the desired **Pictures Per Second** for both the Intensive and Non-Intensive Channels. Resolution and holding duration may also be adjusted for the Intensive Channel.
3. Close the **Intensive Recording** window by selecting the **Apply** button.
4. Open the **Sensors and Outputs** window and enable the sensor that was associated with the Intensive Recording by placing a check in the box next to it
5. Press the **Apply** button and exit out of setup.

5.4.4 VIDEO LOSS ALARM

The DVR supports a Video Loss Alarm function which allows an Alarm Event to occur when a camera loses its signal. The lost signal can be due to Power failure to the camera, the camera cable being cut or unplugged, or the camera being damaged in some way.

In order to use Video Signal Loss detection, cameras must either be turned ON or OFF. This is because the DVR needs to know which cameras it should expect to receive signals from. To turn camera(s) ON, open **Frame Setup**, and set the Frames Per Second to anything above zero. By designating zero frames per second the camera will not be used by the DVR.

1	Activate Audio Alarm (BEEP)	When video loss occurs, an internal speaker on the DVR will sound an alarm.
2	Video Loss Alarm Log	When video loss occurs, the event is recorded in the DVR log.
3	Activate Alarm Output	Activates the last Relay Output on the DVR when camera loses signal. (This is #16 for a 16/32 ch DVR and #8 for an 8ch DVR)

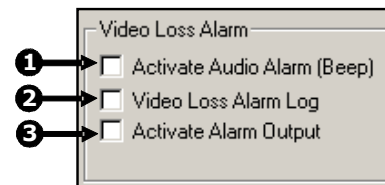

5.4 GENERAL SETUP, CONTINUED

5.4.5 AUDIO RECORDING

The Fusion DVR is capable of recording up to 4 channels of audio.

Audio Features:

- 8000Hz playback in Live Mode
- Audio input level should be 1Vp-p
- Up to 48000Hz playback in search mode
- Mono Sampling
- Line-In type (Requires amplification)

Data Size (per channel):

- 1 Second: 1,625 bytes
- 1 Minute: 97,500 bytes
- 10 Minutes: 975,000 bytes
- 1 Hour: 5,850,000 bytes
- 1 Day: 140,400,000 bytes (approx. 140MB)

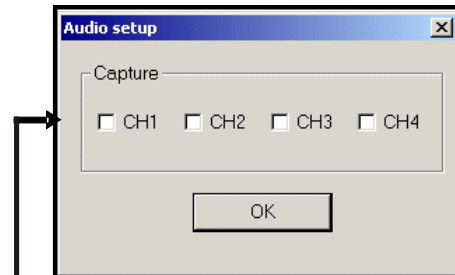

Audio Enable/Disable -
Check boxes to enable audio recording.

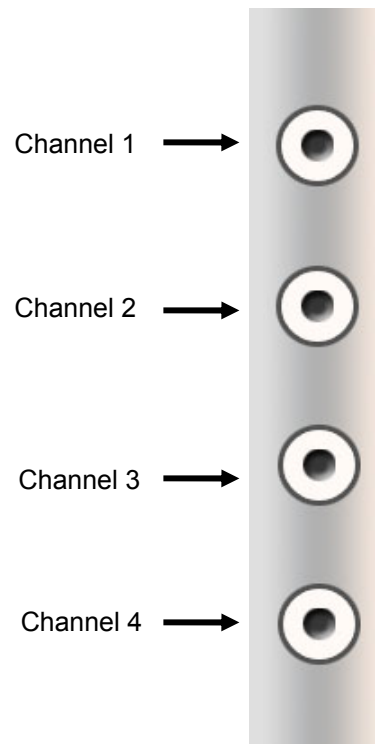

5.5 FRAME SETUP

The Frame Setup menu gives the user the option to adjust both the resolution and the number of images per second each camera will record.

NOTE: The Software will not allow the maximum available Frames to be exceeded.

The screenshot displays the 'Frame Setup' menu with a 'Set Default' button at the top left. Below it is a table with columns for Camera#, FPS, Frame, Resolution, Quality, and Sensitivity. The 'Frame' column contains sliders, and the other columns contain dropdown menus. Numbered callouts are placed around the interface:

- 1**: Points to the 'Set Default' button.
- 2**: Points to the 'Camera#' column.
- 3**: Points to the 'FPS' column.
- 4**: Points to the 'Frame' slider.
- 5**: Points to the 'Resolution' dropdown menu.
- 6**: Points to the 'Quality' dropdown menu.
- 7**: Points to the 'Sensitivity' dropdown menu.

Camera#	FPS	Frame	Resolution	Quality	Sensitivity
01	30	30	720x240	Normal	7
02	30	30	720x240	Normal	7
03	30	30	720x240	Normal	7
04	30	30	720x240	Normal	7
05	0	0	360x240	Normal	7
06	0	0	360x240	Normal	7
07	0	0	360x240	Normal	7
08	0	0	360x240	Normal	7
09	0	0	360x240	Normal	7
10	0	0	360x240	Normal	7
11	0	0	360x240	Normal	7
12	0	0	360x240	Normal	7
13	0	0	360x240	Normal	7
14	0	0	360x240	Normal	7
15	0	0	360x240	Normal	7
16	0	0	360x240	Normal	7

5.5 FRAME SETUP, CONTINUED

1	Set Default	Selecting this option resets all camera frames and resolutions to the default settings.
2	Camera Number	The cameras are given different numbers to distinguish them when viewing the frame status. Adjust the recorded frames per second by sliding the bar to the left and right.
3	Number of Frames	Displays the number of frames that are selected for each camera.
4	Frame Select	Adjusts the frames for each camera.
5	Resolution	Displays the available resolution options. See additional information below.
6	Quality	Affects the quality of the video. Increasing the quality of the camera can considerably reduce the amount of pixilation within the image, but it also increases the file size.
7	Sensitivity	Adjusts the rate at which the key frame refreshes. Sensitivity directly affects the codec being used to record the video. Adjusting this setting can have drastic negative effect on the quality of the video. It is highly recommended that this setting always be left at the default setting unless instructed by a system administrator.

Resolution affects the total number of frames per second that are available. The table below breaks down the number of frames available on a 240IPS DVR.

Frames Available on Fusion DVRs		
	240 IPS	480 IPS
Resolution	Available Frames	
360 x 240	240	480
720 x 240	120	240
720 x 480	60	120

5.6 RECORDING SCHEDULE

Creating a customized Schedule is important to maximize the efficiency of the DVR. This DVR offers numerous options to allow for a wide variety of different needs and requirements.

The screenshot displays the recording schedule configuration interface with the following components and callouts:

- 1:** Pre-Defined Schedules section, including buttons for "All set to Motion", "All set to Continuous", "Default Schedule 1", and "Default Schedule 2".
- 2:** Day Of Week selection area with checkboxes for SUN, MON, TUE, WED, THU (checked), FRI, and SAT, along with a "Single Day Selection" button.
- 3:** The main recording schedule grid showing time slots (0-23) for various schedules (Sch 01 to Sch 12).
- 4:** A "Special day recording schedule" panel on the right, featuring a date selector (4/29/2003), a "Normal Day Mode" button, "Delete special day", and "Save special day" buttons.
- 5:** The "Special day recording schedule" panel, as mentioned above.
- 6:** The "Select All" section, which includes:
 - Camera selection: All Motion (M), All Continue (C), All sensor (S), and Not Selected (X).
 - Camera grid: A 4x4 grid of buttons labeled 01-16 with status icons (M, C, S, X).
 - Sensor selection: A 4x4 grid of buttons labeled 01-16.
 - Relay selection: A 4x4 grid of buttons labeled 01-16.
- 7:** Alarm Options section, including checkboxes for "Sensor Event", "Motion Event", "Remote Alarm", and "Emergency Alarm", along with an "Emergency P:" field set to "10.0.0.80" and a "17 sec." timer with a slider.

5.6 RECORDING SCHEDULE, CONTINUED

1	Pre-Defined Schedules	These schedules are created for the general installation and have been predefined with basic configurations
		All set to Motion – All cameras are set to motion recording (24 hours/day, 7 days/week)
		All set to Continuous – All cameras are set to continuous recording (24 hours/day, 7 days/week).
		Default Schedule 1 – All cameras are set to: ! 8AM-5PM Continuous recording ! 5PM-8AM Motion recording
		Default Schedule 2 – All cameras are set to: ! Motion recording 24 hours/day, 7 days/week. ! Camera 1 associated to sensor input 1 ! Camera 2 associated to sensor input 2 ! Camera 3 associated to sensor input 3, etc.
2	Day of Week	When a day of the week is selected, the currently selected schedule <u>for that day</u> is modified.
3	Schedule Time Chart	Used to select the time for which each schedule will be enabled.
4	Schedule Number	The Schedule Number is simply a group of settings. Up to 32 schedules can be created. Think of the schedules as transparency paper with words written on them. When placed one on top of another, the words can still be seen from the layers below. These schedules allow a powerful detailed recording schedule to be created.
5	Special Day Recording Schedule	Customize a schedule for a particular day, such as a Parade Day, Holiday, etc.
6	Camera, Sensor, Relay	Designate which cameras, sensors, and relays are to be used for the given schedule. These also correlate the sensors and relay to the camera (i.e., which sensors will activate a camera(s), etc.)
7	Alarm Options	These are advanced options that send alarm events (either motion or sensor) to the remote alarm monitor software and FVMS.

5.6 RECORDING SCHEDULE, CONTINUED

5.6.1 DAY OF THE WEEK

The **Day of Week** is simply the day of the week for which the schedule is being edited. If WED is checked, Wednesday's schedule is being edited.

The **Single Day Selection** button allows selection of multiple days at once. By selecting the Single Day Selection button placing multiple checks in the boxes is allowed, thereby selecting multiple days simultaneously.

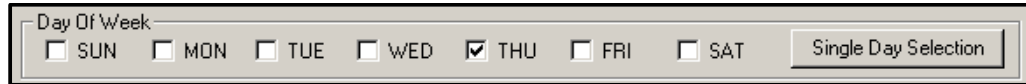

5.6.2 CREATING A SIMPLE SCHEDULE (BY EXAMPLE)

Creating schedules is easy with a little experience.

In the following example, the steps for creating a simple schedule for cameras 1 to 4 are detailed.

The schedule will be as follows:

1. MON-FRI (9AM-5:59PM) all 4 cameras will record using MOTION recording.
2. MON-FRI (6PM-8:95AM) all 4 cameras will record using CONTINUOUS recording.
3. SAT-SUN (12AM-11:59PM) all 4 cameras will record using MOTION recording.

To do this, a total of 3 schedules will be created.

5.6 RECORDING SCHEDULE, CONTINUED

Steps 1-6: Schedule cameras 1-4 to record on MOTION from 9:00am-5:59pm Monday through Friday.

1. Select **Sch01** from the **Schedule Number** drop down list.
(This should already be selected by default)
2. Select the **Single Day Selection** button, then select **Yes**.
3. Place a check in the **MON, TUE, WED, THU, and FRI** days of the week.
4. On the **Sch01** line on time selector grid, highlight hours 09-17.
Press Set.
5. Press **Camera** buttons 1-4 until the green **Motion** buttons are selected.
6. Press **Apply** to save.

The screenshot shows the 'Special day recording schedule' interface. Red circles and arrows highlight the following steps:

- Step 1:** The 'Schedule Number' dropdown menu is highlighted, showing 'Sch 01' selected.
- Step 2:** The 'Multi Day Selection' button is highlighted.
- Step 3:** The checkboxes for MON, TUE, WED, THU, and FRI in the 'Day Of Week' section are highlighted.
- Step 4:** A red box highlights the time period from 09:00 to 17:00 on the 'Sch 01' row of the time selector grid.
- Step 5:** The 'All Motion' button (with a green 'M') is highlighted in the 'Select All' section.

Other visible elements include: 'Normal day mode', 'Delete special day', 'Save special day', 'Set', 'Clear', 'Delete', 'Delete All', 'Sensor' and 'Relay' grids, and 'Alarm Options' (Sensor Event, Motion Event, Remote Alarm, Emergency Alarm).

5.6 RECORDING SCHEDULE, CONTINUED

Steps 7-11: Schedule cameras 1-4 to record on CONTINUOUS from 6:00pm-8:59am Monday through Friday.

7. Select **Sch02** from the **Schedule Number** drop down list.
8. On the **Sch02** line again, highlight the hours 18-23 (for 6:00pm-midnight) and press **Set**.
9. On the **Sch02** line on time selector grid, highlight the hours 00-08 (for midnight to 8:59am) and press **Set**.
10. Press **Camera** buttons 1-4 until the Maroon **Continuous** buttons are selected.
11. Press **Apply** to save.

The screenshot shows a software interface for configuring recording schedules. At the top, a 'Day Of Week' section has checkboxes for SUN, MON, TUE, WED, THU, FRI, and SAT, with MON through FRI checked. A 'Single Day Selection' dropdown is set to '3/16/2003'. Below this is a grid with rows for 'Sch 01' through 'Sch 12' and columns for hours 0-23. Red boxes highlight the 'MON' through 'FRI' days and the '18-23' hour range in the 'Sch 02' row, labeled 'Step 8'. Another red box highlights the '00-08' hour range in the 'Sch 02' row, labeled 'Step 9'. Below the grid, a 'Schedule Number' dropdown is set to 'Sch 02', with 'Set' and 'Clear' buttons. At the bottom, a 'Select All' section has buttons for 'All Motion', 'All Continue', 'All No Record', and 'Not Selected'. A 'Camera' section has buttons 'C 01' through 'C 04', with 'C 01' through 'C 04' highlighted in maroon. A 'Sensor' and 'Relay' section have buttons '01' through '16' for each. Red arrows point to the 'Sch 02' dropdown (Step 7) and the 'C 01' through 'C 04' buttons (Step 10).

5.6 RECORDING SCHEDULE, CONTINUED

Steps 12-19: Schedule cameras 1-4 to record on MOTION from 12:00am-11:59pm Monday through Friday

12. Select the **Multi-Day Selection** button.
13. Place a check in the SAT days of the week box.
14. Select **Sch03** from the **Schedule Number** drop down list.
15. Select the **Single Day Selection** button, then select **Yes**.
16. Place a check in the **SAT** and **SUN** days of the week boxes.
17. On the **Sch03** line on the time selector grid, highlight hours 00-23 and press the **Set** button.
18. Press **Camera** buttons 1-4 until the Green **Motion** buttons are selected.
19. Press **Apply** to save.

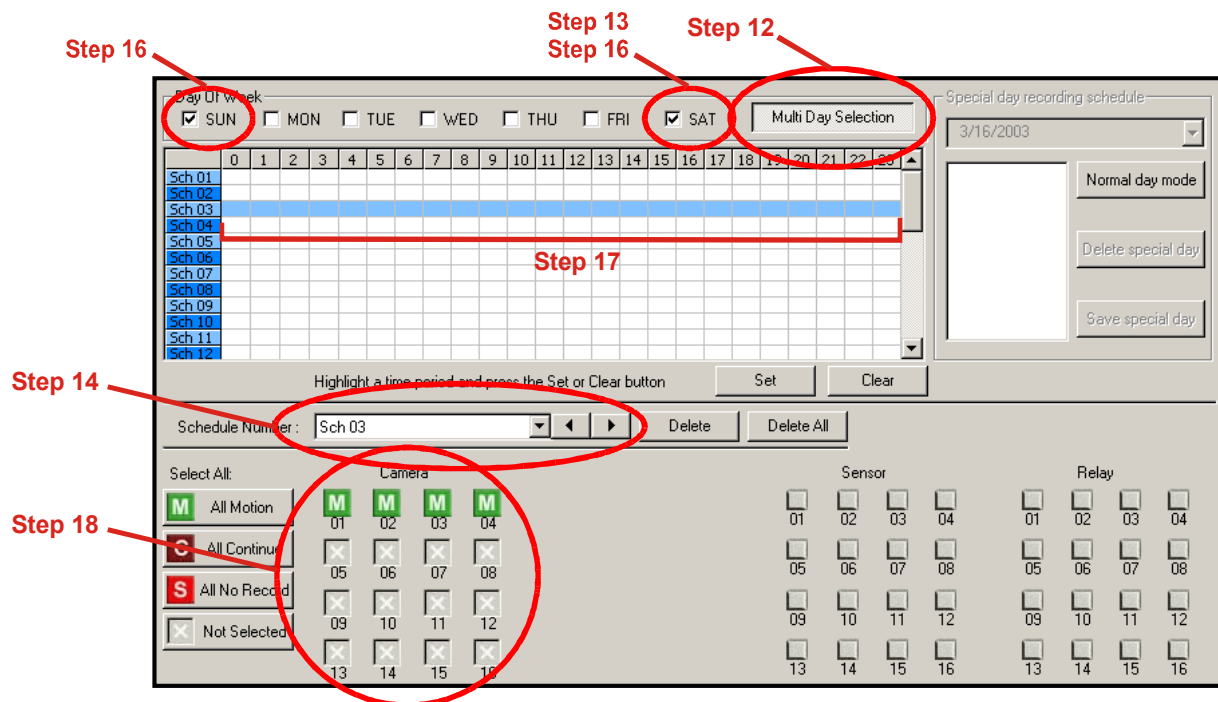

5.6 RECORDING SCHEDULE, CONTINUED

5.6.3 SCHEDULING SENSORS AND RELAYS (BY EXAMPLE)

It is easy to add advanced recording functionality using Sensor Inputs and Relay Outputs.

SENSOR - Sensor Inputs can be programmed to instantly start one or more cameras recording when an alarm occurs. These alarm events can also activate Relay Outputs as desired.

RELAY OUTPUT - Relay Outputs can be set to activate when motion alarms or sensor alarms occur.

The schedule will be as follows:

1. SUN-SAT (12AM-11:59PM) Cameras 1 and 2 will be activated on Sensor #3 and/or Sensor #5, which will then activate Relay Output #7 and #13.
2. SUN-SAT (12AM-11:59PM) Camera 3 will be set to Record on MOTION. When motion occurs it will activate Relay Output #7 and #10.
3. SUN-SAT (12AM-11:59PM) Sensor #6 will activate Relay Output #8 when an alarm occurs. This event will NOT cause any cameras to record.

To do this, a total of 3 schedules will be created.

5.6 RECORDING SCHEDULE, CONTINUED

Steps 1-8: Schedule cameras 1 and 2 to be activated on Sensor # 3 and/or Sensor #5 which will then activate Relay Output #7 and #13.

1. Select **Sch01** from the **Schedule Number** drop down list.
(This should already be selected by default.)
2. Select the **Single Day Selection** button, then select **Yes**.
3. Place a check in the boxes for **SUN, MON, TUE, WED, THU, FRI,** and **SAT** days of the week.
4. On the **Sch01** line (time selector grid), highlight the hours 00-23 and press **Set**.
5. Press **Camera** buttons #1 and #2 until the Red **Sensor** buttons are selected.
6. Press **Sensor** buttons #3 and #5.
7. Press **Relay** buttons #7 and #13.
8. Press **Apply** to save.

Day Of Week
 SUN MON TUE WED THU FRI SAT

	0	1	2	3	4	5	6	7	8	9	10	11	12	13	14	15	16	17	18	19	20	21	22	23
Sch 01																								
Sch 02																								
Sch 03																								
Sch 04																								
Sch 05																								
Sch 06																								
Sch 07																								
Sch 08																								
Sch 09																								
Sch 10																								
Sch 11																								
Sch 12																								

Highlight a time period and press the Set or Clear button

Special day recording schedule
 3/17/2003

Schedule Number: Sch 01

Select All: All Motion All Continue All No Record Not Selected

Camera: 01 02 03 04 05 06 07 08 09 10 11 12 13 14 15 16

Sensor: 01 02 03 04 05 06 07 08 09 10 11 12 13 14 15 16

Relay: 01 02 03 04 05 06 07 08 09 10 11 12 13 14 15 16

5.6 RECORDING SCHEDULE, CONTINUED

**Steps 9-15: Schedule camera 3 to record using MOTION.
When Motion occurs it will activate Relay Output #7 and #10.**

9. Select **Sch02** from the **Schedule Number** drop down list.
10. Select the **Single Day Selection** button, then select **Yes**.
11. Place a check in the boxes for **SUN, MON, TUE, WED, THU, FRI,** and **SAT** days of the week.
12. On the **Sch02** line (time selector grid), highlight the hours 00-23 and press **Set**.
13. Press **Camera** button #3 until the green **Motion** button is selected.
14. Press **Relay** buttons #7 and #10.
15. Press **Apply** to save.

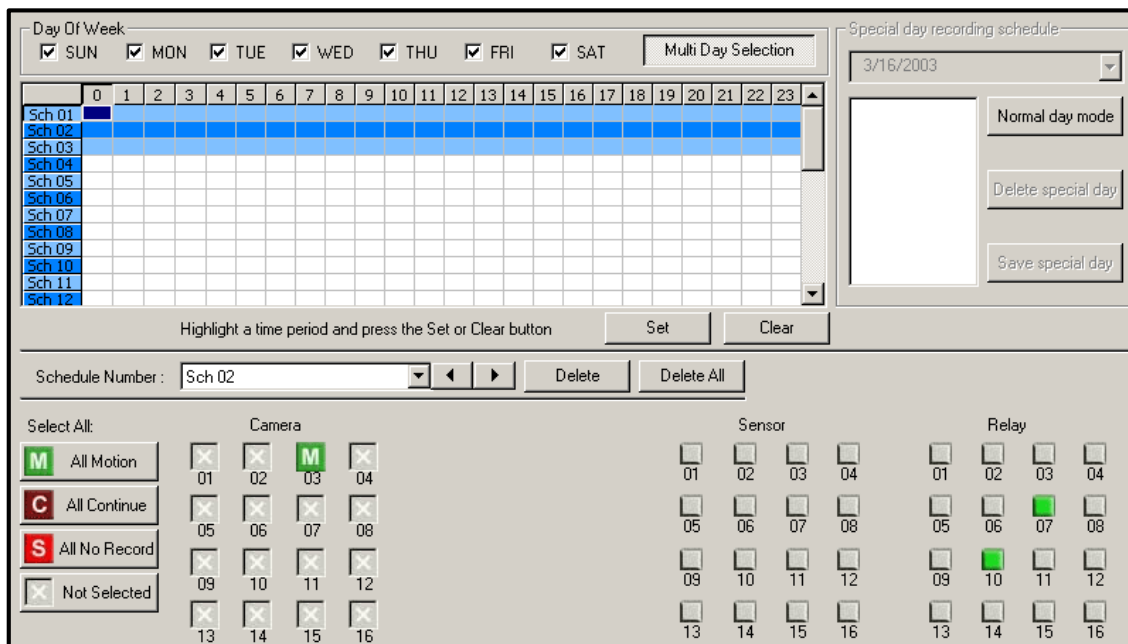

5.6 RECORDING SCHEDULE, CONTINUED

**Steps 16-22: Schedule Sensor #6 to activate Relay #8 when an Alarm occurs.
NOTE - This will not cause any cameras to record.**

16. Select **Sch03** from the **Schedule Number** drop down list.
17. Select the **Single Day Selection** button, then select Yes.
18. Place a check in the boxes for **SUN, MON, TUE, WED, THU, FRI,** and **SAT** days of the week.
19. On the **Sch03** line (time selector grid), highlight the hours 00-23 and press **Set**.
20. Press **Sensor** button #6.
21. Press **Relay** button #8.
22. Press **Apply** to save.

Day Of Week
 SUN MON TUE WED THU FRI SAT

	0	1	2	3	4	5	6	7	8	9	10	11	12	13	14	15	16	17	18	19	20	21	22	23
Sch 01																								
Sch 02																								
Sch 03																								
Sch 04																								
Sch 05																								
Sch 06																								
Sch 07																								
Sch 08																								
Sch 09																								
Sch 10																								
Sch 11																								
Sch 12																								

Highlight a time period and press the Set or Clear button

Special day recording schedule
 3/16/2003

Schedule Number : Sch 03

Select All:

Camera				Sensor				Relay			
<input type="checkbox"/> 01	<input type="checkbox"/> 02	<input type="checkbox"/> 03	<input type="checkbox"/> 04	<input type="checkbox"/> 01	<input type="checkbox"/> 02	<input type="checkbox"/> 03	<input type="checkbox"/> 04	<input type="checkbox"/> 01	<input type="checkbox"/> 02	<input type="checkbox"/> 03	<input type="checkbox"/> 04
<input type="checkbox"/> 05	<input type="checkbox"/> 06	<input type="checkbox"/> 07	<input type="checkbox"/> 08	<input type="checkbox"/> 05	<input checked="" type="checkbox"/> 06	<input type="checkbox"/> 07	<input type="checkbox"/> 08	<input type="checkbox"/> 05	<input type="checkbox"/> 06	<input type="checkbox"/> 07	<input checked="" type="checkbox"/> 08
<input type="checkbox"/> 09	<input type="checkbox"/> 10	<input type="checkbox"/> 11	<input type="checkbox"/> 12	<input type="checkbox"/> 09	<input type="checkbox"/> 10	<input type="checkbox"/> 11	<input type="checkbox"/> 12	<input type="checkbox"/> 09	<input type="checkbox"/> 10	<input type="checkbox"/> 11	<input type="checkbox"/> 12
<input type="checkbox"/> 13	<input type="checkbox"/> 14	<input type="checkbox"/> 15	<input type="checkbox"/> 16	<input type="checkbox"/> 13	<input type="checkbox"/> 14	<input type="checkbox"/> 15	<input type="checkbox"/> 16	<input type="checkbox"/> 13	<input type="checkbox"/> 14	<input type="checkbox"/> 15	<input type="checkbox"/> 16

5.6 RECORDING SCHEDULE, CONTINUED

5.6.4 VERIFYING A RECORDING SCHEDULE

1. Select a single day of the week using the selection check box to the left of the specified day.
2. Next move down to the schedule grid.
3. Identify the schedule (or schedules) that have specific hours of the day high-lighted in light blue color. The horizontal axis of the schedule grid corresponds to the 24 hours of each day.
4. After verifying that all hours of the selected day are covered by at least one of the 32 independent schedules (vertical axis of schedule grid) now move your attention to the lower half of the schedule interface.
5. In the "Schedule Number:" selection drop down box, select the schedule(s) that were defined above for the current day and verify in each schedule number that the correct cameras are set to Continuous, Motion or Sensor based recording.

NOTE: If a specific camera is not to be recorded on a given day/schedule combination set the camera to "Not Selected", a white "X".

6. Proceed to repeat this process for each of the 7 days of the week until certain that the desired recording method is configured for each day.

5.7 SENSOR SETUP

The **Sensor Window** options enable, disable, and configure Sensors.

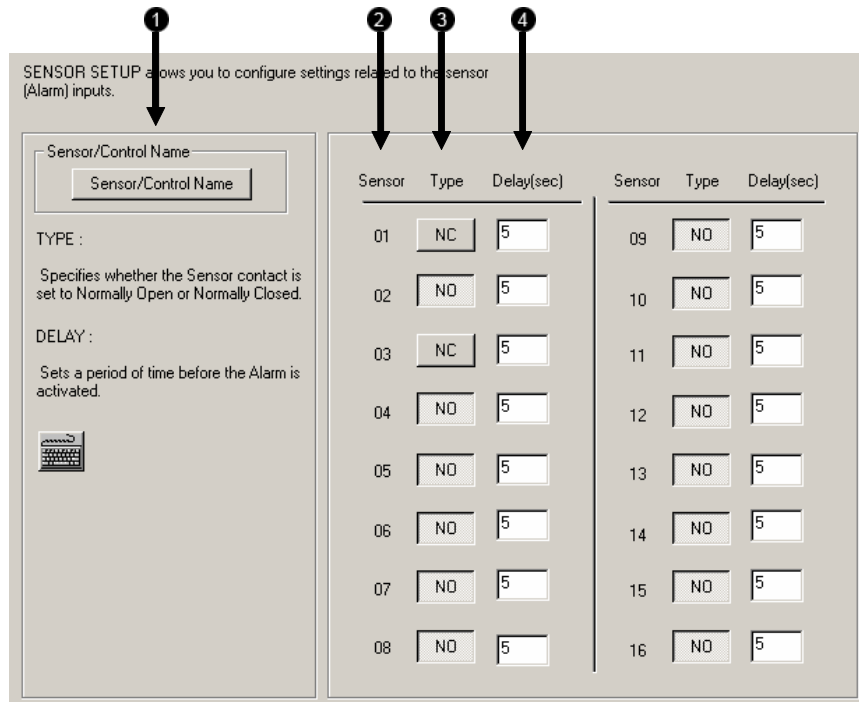

1	Sensor/Control Name	Opens a menu to allow custom naming of controls and sensors for easy identification.
2	Sensor	Displays the sensor number
3	Type	Selects whether the Sensor will be Normally Open (NO) or Normally Closed (NC).
4	Delay (sec)	Once the recording duration has expired, the Delay(sec) will wait to reactivate the alarm.

5.8 NETWORK SETUP



CAUTION: Do not join this DVR to a Network Domain. Domains push across policies that can negatively affect the DVR. More importantly, by default, the user must press CTRL ALT DEL to login. This Keyboard combination is disabled and the software will not be able to load.

NETWORK SETUP allows you to enable and configure the remote access to the DVR.

1 Disable Remote Control

2 TimeOut Value : 60

3 Emergency Port : 4001 (1024 - 5000)

4 Center Port : 4000 (1024 - 5000)

5 Image Port : 4002 (1024 - 5000)

6 Search Port : 4003 (1024 - 5000)

7 Enable Web Viewer

8 Internet Port : 4004

9 DVR Site Information

10 DVR Site Information Port : 2005

11 Transport Setup

Quality : NORMAL

Resolution : 360*240

Transport Rate : 100

12 These settings affect the quality and speed of the video that is sent to the remote clients.

13

14 Enable Audio Communication

Audio Port : 3002

15 View IP, DNS and Gateway Information: View IP address

16

1	Disable Remote Control	This setting enables or disables access to the DVR from remote connections.
2	Time Out Value	When a user attempts to connect to the DVR and the connection does not succeed during the timeout period designated, the connection will be terminated.
3	Emergency Port	The Emergency Port is the port used to connect with the Alarm Monitor software. If connecting through a firewall, this port must be opened to incoming and outgoing traffic.

5.8 NETWORK SETUP, CONTINUED

4	Center Port	The Center Port is the port used to connect to the Fusion Remote Software. This is the Port that must be specified inside the Fusion Remote software to connect to the DVR. If connecting through a firewall, this port must be opened to incoming and outgoing traffic.
5	Image Port	The Image Port is the port used to transfer the video to the Fusion Remote Software. If connecting through a firewall, this port must be opened to incoming and outgoing traffic.
6	Search Port	The Search Port is the port used to transfer the Search information to the Fusion Remote Software. If connecting through a firewall, this port must be opened to incoming and outgoing traffic.
7	Web Function	Enables the use of the Web DVR interface as well as defines users who can access it.
8	Internet Port	This is the Port that is used by the DVR to transmit images through the Internet.
9	DVR Site Information	Allows FVMS to receive information regarding the health of the DVR.
10	DVR Site Information Port	Sets the port DVR Health information is transmitted over. This port must match the port set in FVMS.
11	Quality	Adjusts the resolution quality when transferring video to a remote client.
12	Resolution	Adjusts the resolution of the images being sent to remote clients. By setting the resolution low, the images will be sent faster, however, the image quality will be reduced considerably. When set to Original, full quality video will be sent (720 x 480) however this is very bandwidth intensive.
13	Transport Rate	This option is used to throttle the bandwidth on the DVR. This option is based on percentages of images sent.
14	View IP Address	This option allows you to view the IP configuration of the DVR.
15	PPP Setup (Emergency)	Defines the modem and PPP information to dial to a remote client when an Alarm Monitor Event is activated.
16	Enable Audio Communication	Allows one way audio communication from a remote client to the DVR.

5.9 ADMINISTRATION

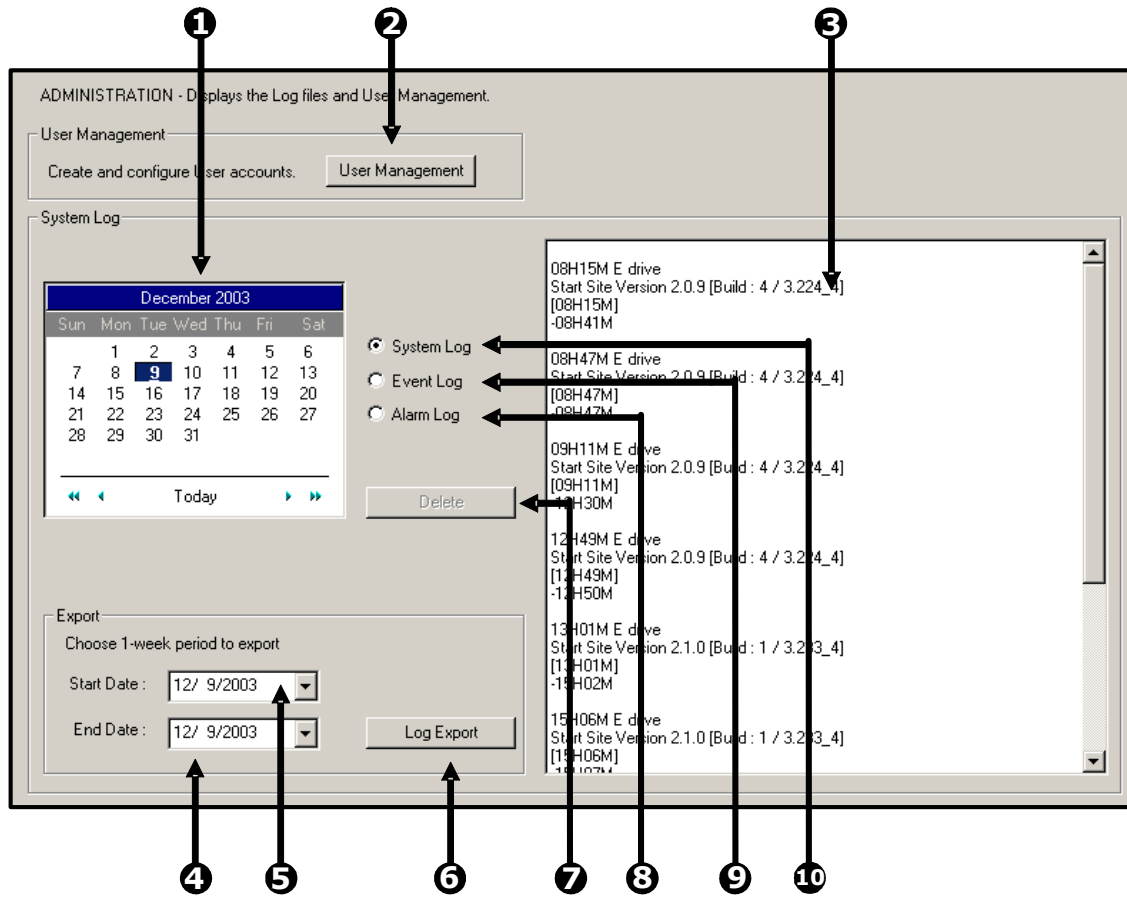

1	Calendar	Displays the days with Log information in a bold format.
2	User Management	Opens the User Management Window to create, edit, and delete DVR user accounts.
3	Log Display Window	Displays the Log Files of the selected day.
4	End Date	Specifies a date to end the Log Export function.
5	Start Date	Specifies a date to begin the Log Export function.
6	Log Export	Allows the log file to be exported in weekly increments.
7	Delete	Deletes the selected log files.
8	Alarm Log	Displays information pertaining to Alarm Events.
9	Event Log	Displays information pertaining to User Logins, DVR reboots and other related information.
10	System Log	Displays the Hardware Log file information which includes recording successes and failures.

5.9 ADMINISTRATION, CONTINUED

5.9.1 USER MANAGEMENT

The User Management Console has options for creating, editing, and deleting user accounts. Each user account can be assigned different privileges that limit their usage of the DVR system. Users can be given administrator privileges by enabling all rights, however only the true administrator account can log into the User Management Console

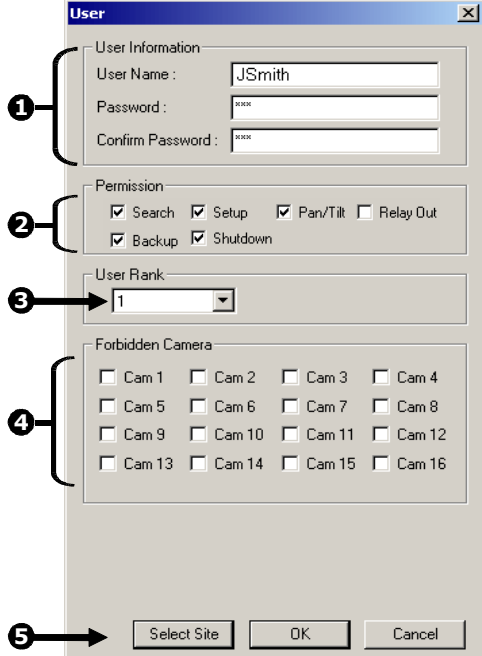
1	User Information	Enter the User Information and Password.	
2	Permission	Used to specify the types of permissions a user may perform on the DVR.	
3	User Rank	This option defines hierarchal privileges when conflicts arise with PTZ and Setup access. (one being the highest priority)	
4	Forbidden Camera	Allows an administrator to hide certain cameras from a user. The user will not be able to view the cameras in Live Mode.	
5	Select Site	(Only used with the Central User Management software). This option defines the DVRs to which the User has access.	
<p>NOTE: Every DVR comes with an Administrative account and Default account loaded on them. The Default account should not be used as the primary account. Upon a reboot of the unit for any reason the Default account will automatically be loaded. For applications where maximum security is essential, it is recommended that all privileges be stripped from the Default user account and all cameras be set to Forbidden.</p>			

5.9 ADMINISTRATION, CONTINUED

5.9.2 USER RANK

The User Ranking structure allows the option to assign a privilege system (1-10 where one has the most rights) to users of the DVR. For example. Since only one user is allowed to use the PTZ controls at any one time, an administrator with a higher rank can kick another user out and take control of the PTZ.

The User Rank option affects:

SETUP ACCESS	Each DVR can only have 1 user accessing Setup at any given time. A user with a higher rank will kick another user out and then open Setup.
PTZ CONTROL	Each DVR can only have 1 user using the PTZ controls at any given time. A user with a higher rank will kick another user out and then open the PTZ controls.

5.9.3 CHANGING THE ADMINISTRATOR PASSWORD

1. Inside Setup, open the user management console. An administrator login will appear with a **Change Password** button near the bottom right of the window.
2. Select the Change **Password** button, then enter the new password and press **OK** to finish.

5.10 SITE INFORMATION

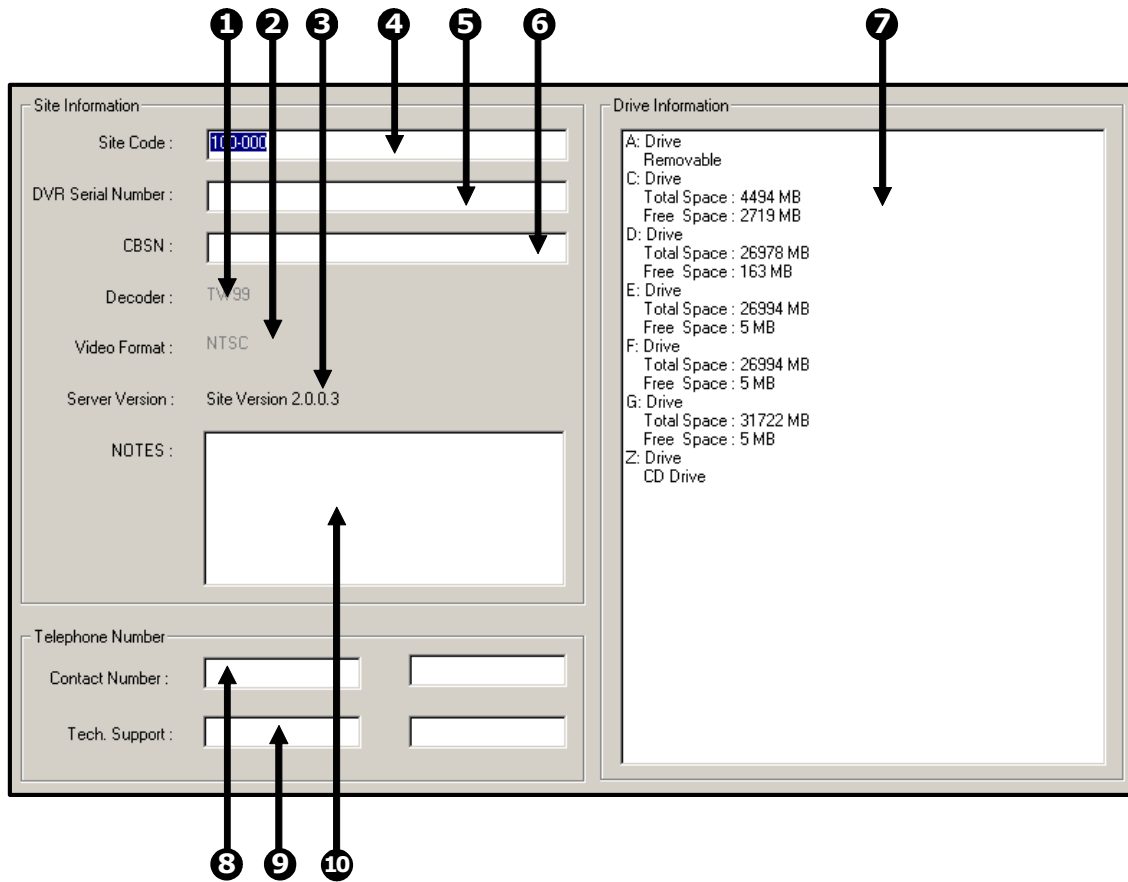

1	Decoder	Displays decoder information.
2	Video Format	Displays Video Format (NTSC/PAL) of the DVR.
3	DVR Server Version	Displays the software version on the DVR.
4	Site Code	A user-specified unique identification name that is used by other DVR software to connect to the DVR (Fusion Remote, Alarm Monitor, FVMS).
5	DVR Serial Number	Displays the serial number of the DVR.
6	CBSN	Displays the serial number of an internal hardware component inside the DVR.
7	Drive Information	Displays the Total Space and Free Space of the drives installed in the DVR.
8	Contact Number	Displays a user-specified Contact phone number.
9	Tech Support	Displays Tech Support phone number.
10	Notes	Enter any notes about the DVR.

5.11 PTZ

The PTZ Setup enables PTZ cameras, creates Presets, Tours, and adjusts speed settings. Many options listed here are features only available on selected cameras. Refer to the Advanced PTZ chapter in this manual for description on setting up a PTZ camera and PTZ options. Please refer to the section 7 for more information.

5.12 INSTANT RECORDING

Instant Recording is a feature that allows manual starting of a camera recording, superceding the current schedule. When Instant Recording is activated on a camera it also flags the specified video so that an Index Search can be performed at a later date to bring up all the Instant Recording instances.

This can be used, for example, when a suspicious object or person is being recorded and you want to flag that section of video for easy retrieval at a later date.

Activate Instant Recording

1. From the Live View screen, double right-click on the camera on which to enable instant recording. An INSTANT label will be placed on the upper right corner of the video.
2. To turn the Instant Recording option OFF, double right-click the video a second time.

Searching 'Instant Recorded' Video

1. Enter the Search Mode, press the INDEX SEARCH button, and then select the INSTANT RECORDING option.

5.13 ADJUSTING THE TIME, DATE, AND TIME ZONE

Exit to Windows by pressing the **Exit** button from the Main Display Screen and selecting **Restart in Windows Mode**. (See Section 4.3 – Display Screen.)

1. Open **Windows Explorer** by clicking on the **My Computer** icon (generally located at the top left-hand corner of the Desktop) and select **Explorer**.
2. Double-click on **Control Panel** to open it. If **Control Panel** is not listed, double-click **My Computer** to expand the folder tree.
3. Double-click **Date/Time** inside the Control Panel.

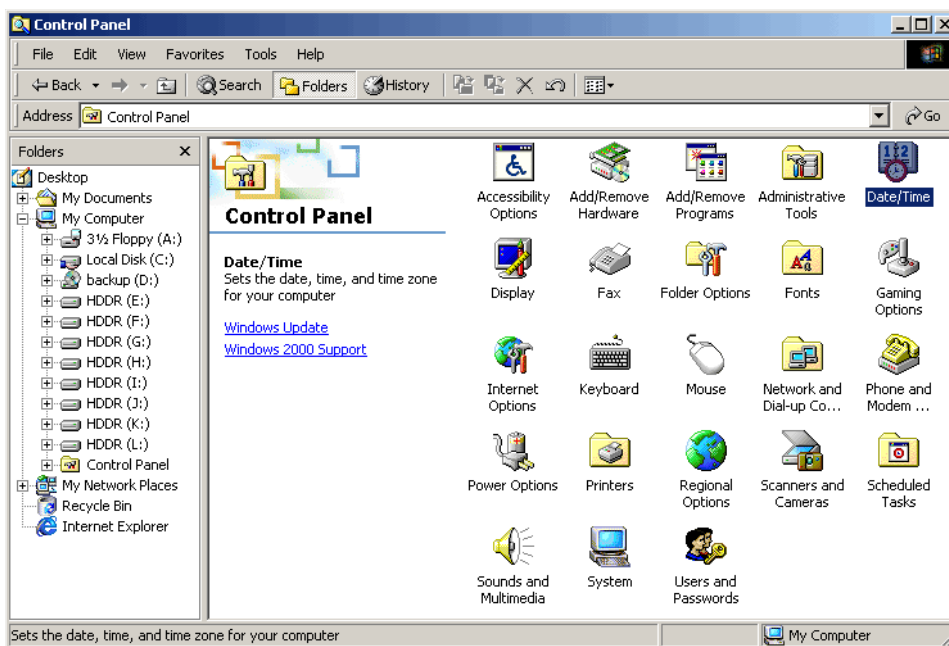

4. Adjust the date, time, and time zone.
5. When finished, close all open windows and restart the DVR unit by selection **Start → Shut Down**.

5.14 CENTRAL USER MANAGEMENT (OPTIONAL)

The Fusion DVRs are capable of utilizing a Central User Management system. This option allows, from one location, the creation, deletion and management of user accounts on multiple DVRs. This makes managing a large amount of DVRs easy and organized.

The Central User Management program is run on a computer or DVR that is to be used as the 'hub'. This computer (or DVR) acts as a broadcaster to send out updated information. The diagram below provides an overview of how the Central User Management functions.

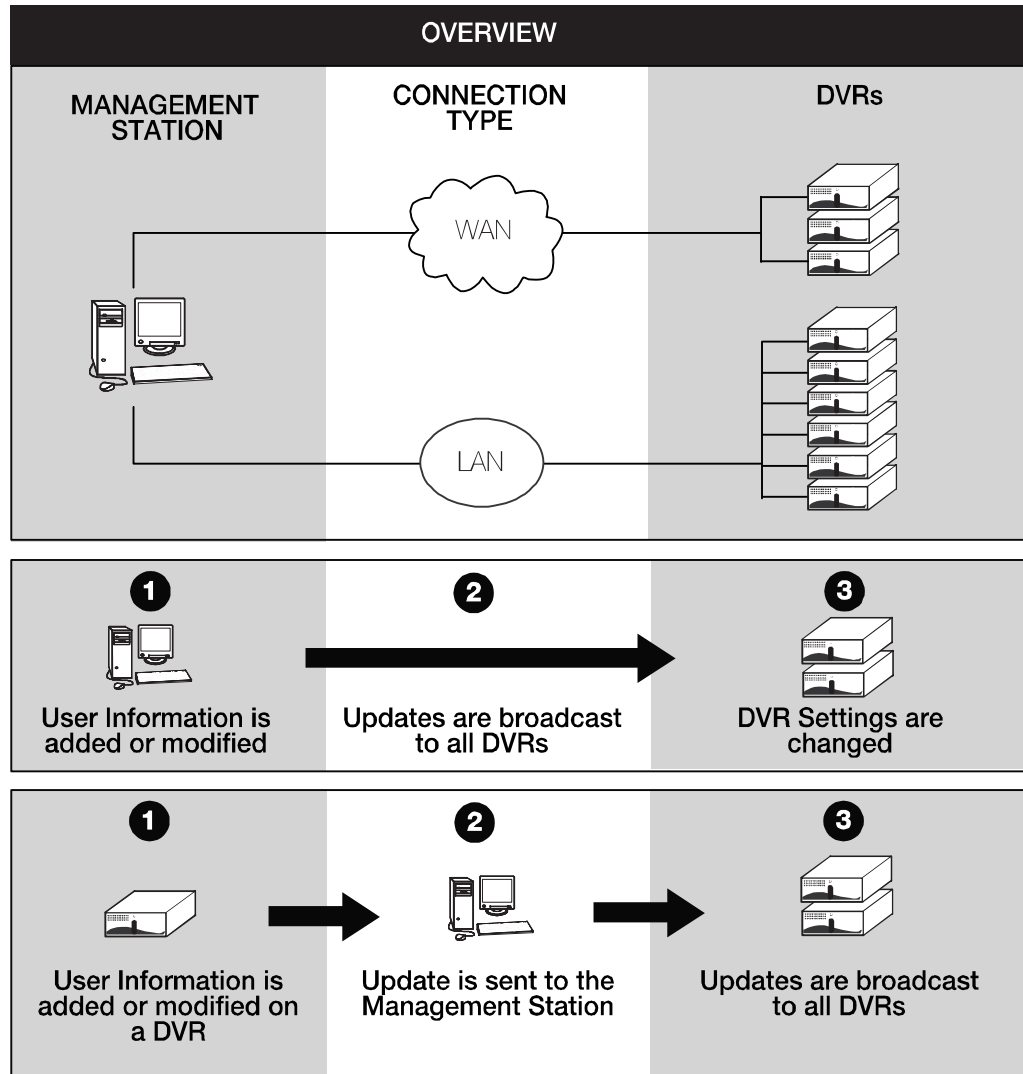

User Accounts can be modified from any DVR as well as the Management Station. Any changes made on a DVR will be sent to the Management Station which in turn will broadcast the changes to all DVRs.

5.14 CENTRAL USER MANAGEMENT, CONTINUED

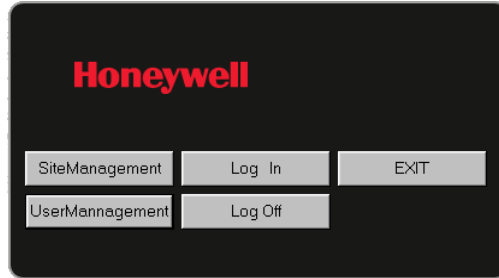

Site Management	This option will Add/Delete DVRs that are managed by the Central User Management Software.
User Management	This option will Add/Delete/Modify User Accounts and User access privileges.
Log In	Only the Administrator can modify settings. In order to open the Site Management or User Management options, the Administrator must login.
Log Out	This option logs the Administrator OFF and locks access to the Site Management and User Management options.
Exit	This option Exits the Management Station Software.

5.14 CENTRAL USER MANAGEMENT, CONTINUED

5.14.1 SITE MANAGEMENT

The Site Management window is where DVRs are added and deleted from the managed list.

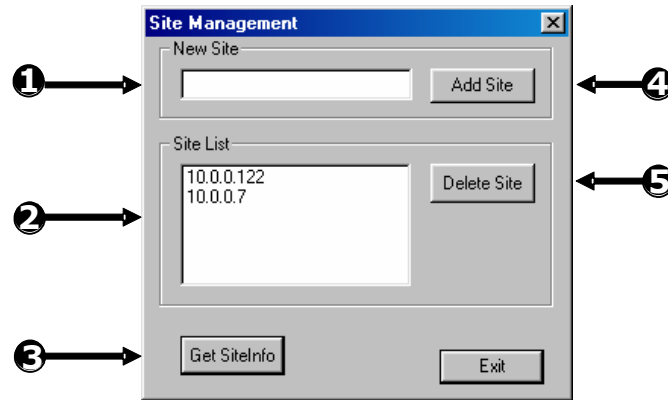

1	IP Entry Field	Used when adding a new DVR. This field accepts standard IP addresses.
2	Site List	Display the current DVRs being managed by the Central User Management Software.
3	Get Site Info	Updates the information from each DVR.
4	Add Site	Once the IP is entered into the IP Entry Field, pressing ADD Site will add it to the Site List. .
5	Delete Site	This option deletes a selected site from the Site List.

5.14 CENTRAL USER MANAGEMENT, CONTINUED

5.14.2 USER MANAGEMENT

The User Management options are where the User Privileges are specified.

The User Management Console has the ability to create, edit, and delete user accounts. Each user account can be assigned different privileges that limit their usage of the DVR system. Users can be given administrator privileges by enabling all rights, however only the true administrator account can log into the User Management Console.

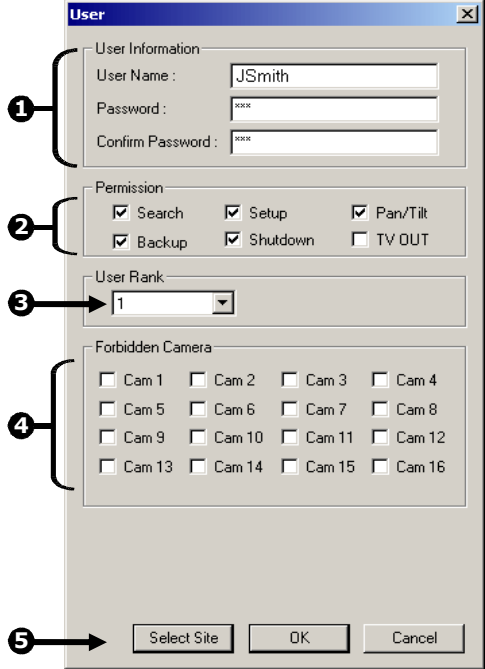
1	User Information	Enter the User Information and Password.	
2	Permission	Used to specify the types of permissions a user may perform on the DVR.	
3	User Rank	This option defines hierarchal privileges when conflicts arise with PTZ, Setup and Login access.	
4	Forbidden Camera	Allows an administrator to hide certain cameras from a user. The user will not be able to view the cameras in Live Mode.	
5	Select Site	Defines the DVRs to which the User has access.	

5.14 CENTRAL USER MANAGEMENT, CONTINUED

5.14.3 SELECT SITE

This option defines the DVRs to which the User has access.

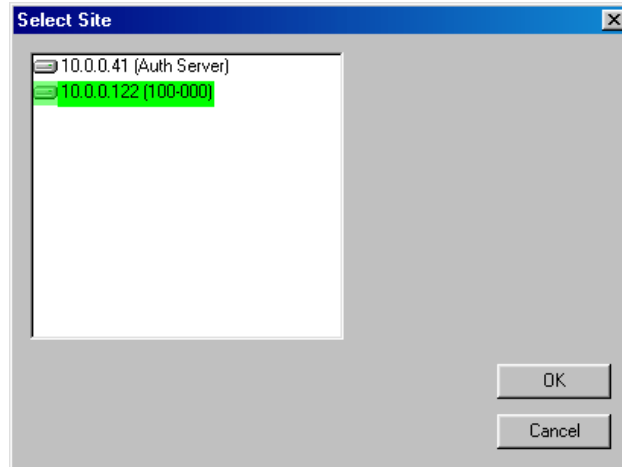

To select a Site simply click on it. It will become highlighted. Select the Site again to deselect it.

5.14.4 SETTING UP THE CENTRAL MANAGEMENT USER SERVER

To set up a Central Management User Server follow these steps.

1. Install the Central Management User Software on a computer or DVR.
2. Run the software and open Site Management. (Logging in may be necessary)
3. Add one or more DVRs to the list and press **OK** to save and exit Site Management.
4. Open User Management.
5. Add or edit User settings and press **OK** to save and exit.
6. Minimize the Central User Management Software.

NOTE: If the software is closed, any updates made on the DVRs will not be broadcast to the other DVRs.

5.14 CENTRAL USER MANAGEMENT, CONTINUED

5.14.5 ENABLING A DVR TO USE CENTRAL USER MANAGEMENT

To enable a DVR to use the Central User Management software follow these steps

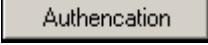
1. Select the  button from the User Management Window.
2. Place a Check in the **Enable User Central Management** box.
3. Enter the IP address of the Authentication Server running the Central User Management software.
4. Enter the Server Port used by the Authentication Server. (Must be between 7000-7100)
5. Enter a Site port that the DVR will use to communicate with the Authentication Server. (Must be between 6000-6100)
6. Press OK to save and close.

5.15 TV OUTPUT CONTROL SETUP (OPTIONAL)

The 4 Channel TV Output Card allows selectively of each of the four video outputs to an analog device (such as a TV Monitor).

This device supports multiple features such as:

- Camera Selectable Single Channel Sequencing
- Output based on Sensor activation
- Output based on Motion detection
- 4 outputs – each customizable.

With the addition of the 4 Channel Output card, the selection of individual cameras to display is available. This allows versatility and flexibility in displaying cameras where they need to be viewed.

5.15 TV OUTPUT CONTROL SETUP (OPTIONAL), CONTINUED

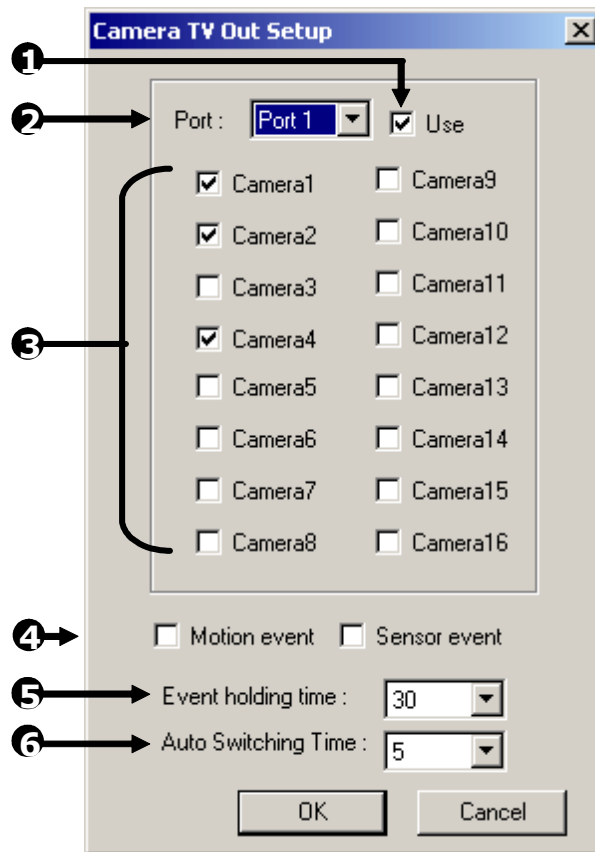

1	Use	Enables the selected Port.
2	Port	Refers to the output channel. The Ports use RCA jacks.
3	Cameras	The camera buttons allow selection of cameras to sequence on the selected Port.
4	Motion/Sensor Event	This option allows immediate output of a Motion or Sensor Event on the selected Port.
5	Event Holding Time	The Event Holding Time specifies the duration for which the Motion or Sensor Event will be displayed.
6	Auto Switching Time	The Auto Switching Time specifies the duration which the selected cameras will sequence one to the next.

5.15 TV OUTPUT CONTROL SETUP (OPTIONAL), CONTINUED

5.15.1 CUSTOMIZING THE TV OUTPUTS

To set up the TV OUTPUT CONTROLS follow these steps.

1. Select the TV OUT button from the General tab inside setup.
2. Select a Port (one of the 4 available output channels) to modify by selecting a Port from the Port dropdown box.
3. Place a check in the **USE** option to enable the Port.
4. Select one or more cameras to be sequentially outputted on the Port.
5. Select the optional Motion Event and/or Sensor Event checkbox.
6. Select a desired Event Holding time (This option is only necessary if the Motion/Sensor Event options are used).
7. Select the desired Auto Switching Time.
8. Press **OK** to save.

SECTION 6 SEARCH OPTIONS

6.1 SEARCH OVERVIEW

The DVR unit has several options that allow easy searching to find a particular section of video. From Motion and Sensor indexing to calendar views showing which days have recorded video, the DVR unit is equipped to quickly find what you're seeking.

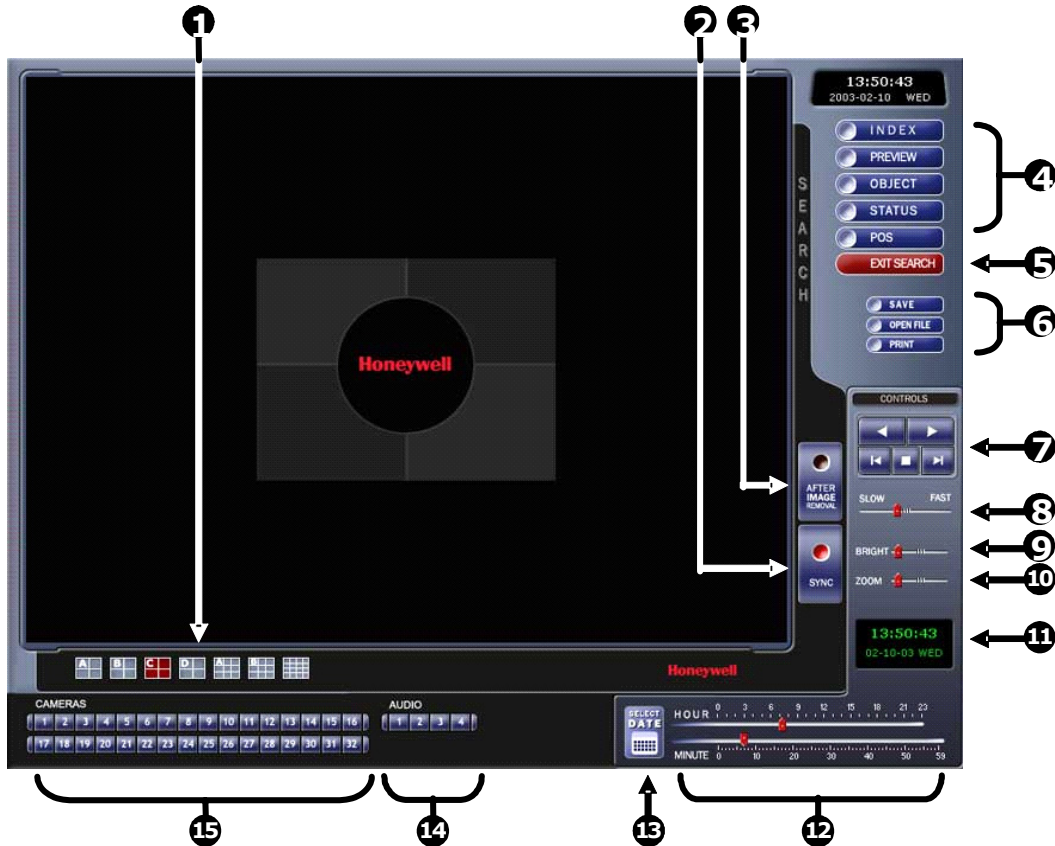

1	Screen Division Buttons	The Screen Division buttons provide views of one or more sets of cameras at a time.
2	Sync	Synchronizes a single channel of video to playback in real time. (ordinarily the video may playback slower or faster depending on several factors including how many PPS recorded and number of cameras playing at the same time.)

6.1 SEARCH OVERVIEW, CONTINUED

3	After Image Removal	Often times, extensive motion can create a 'digital blur' that can interfere with the quality of an image. By selecting the Clean Image option, two frames are interwoven to create a smooth, detailed image. This option only pertains to the 720x480 resolution.
4	Search Options	The search options are a set of functions that provide a way to easily find specific video clips and export them to a usable format
5	Exit Search	Exits the Search Mode and returns to Live Mode.
6	Save/ Open File / Print	Allows a user to save single images to disk, print images, and load saved video from disk.
7	Play Controls	Allows a user to view selected video frame by frame, normal speed, and fast forward.
8	Slow / Fast	Decreases or increases playback speed.
9	Bright	Adjusts the brightness of the selected camera.
10	Zoom	Increase the size of the image (up to full screen).
11	Search Date and Time	Displays the date and time of the video being played.
12	Hour/Minute Control	Select the hour and minute by adjusting the sliding bar.
13	Select Date	Opens a calendar window and allows selection of a day to use within a search.
14	Audio Channels	Displays the audio channel buttons to allow audio playback. NOTE: Audio buttons are only viewable when one camera is selected.
15	Camera	Enable or disable selected cameras for use when searching.

6.2 PLAY CONTROLS

The Play Controls give the ability to play the video Frame by Frame, Normal Speed, and Reverse.

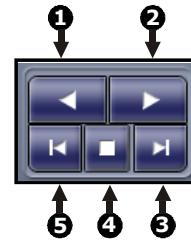

1	Play Reverse	Plays the video at normal speed in reverse.
2	Play (Normal Speed)	Plays the video at normal speed
3	Play (Frame by Frame)	Plays the video one frame at a time. Each time the button is pressed, the video progresses by one frame.
4	Stop	Stops the video that is playing.
5	Play Reverse (Frame by Frame)	Plays the video one frame at a time in reverse. Each time the button is pressed, the video progresses by one frame in reverse.

6.3 HOUR / MINUTE SELECTOR

The Hour/Minute Control Bar allows a user to select the Hour and Minute using an easy-to-use slide bar. The user can control the slide bar not only by clicking and dragging the slider but also using the Wheel on the Scroll Mouse.

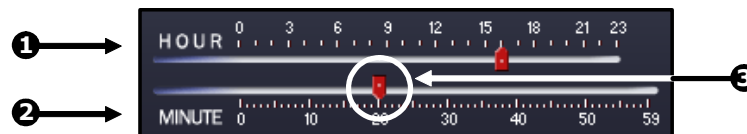

1	Hour Selector	Displays the hours 0 to 24 for a given day. Move the slide bar up and down to select an hour.
2	Minute Selector	Displays the minutes 0 to 60 for a selected hour.
3	Slide Bar Selector	Move up and down to select the hour and minute HINT: By using the Wheel on the mouse, a user can easily move the Slide Bar Selector up and down. Simply click on the Slide Bar Selector with the mouse and then begin moving the Wheel up and down.

6.4 BRIGHTNESS / SPEED / ZOOM

The Brightness and Zoom features can get the most out of the images. Adjusting Brightness can brighten up an image to get more detail. Zoom can not only bring the image up full screen but also Zoom into a particular area of the image.

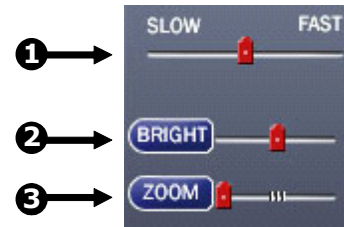

1	Slow / Fast	Increases or decreases playback speed.
2	Brightness	Used to adjust the brightness of an image.
3	Zoom	Used to zoom in on an image.

6.4.1 ADJUSTING THE BRIGHTNESS OF AN IMAGE

1. Select a single image to adjust by double-clicking on the desired image. Multiple images cannot be adjusted at one time.
2. Move the **Bright** slide bar to the right or left to adjust the brightness.
3. Reset the brightness by pressing the **Bright** button.

6.4.2 ZOOMING IN ON AN IMAGE

1. Select a single image to adjust by double-clicking on the desired image. Multiple images cannot be adjusted at one time.
2. Move the **Zoom** slide bar to the right or left to zoom in or out of an image.
3. Reset the zoom by pressing the **Zoom** button.

6.4.3 ZOOMING IN ON A PORTION OF AN IMAGE

1. Using the mouse pointer, point to the area of interest on the image and press the right mouse button.
2. Repeated pressing of the right mouse button will zoom in further.
3. Continue clicking the right mouse button and the image zoom will cycle back to the original size.

6.5 AFTER IMAGE REMOVAL

The DVR unit is capable of recording video using one of three different resolutions. When using the 720 x 480 resolution, two fields are mixed. Because of the timing gap between the two fields, according to the standardized image rules, after image might occur to high speed moving images. The Fusion DVR unit allows you to remove this by pressing the **After Image Removal** button.

The images below demonstrate the filtered screen.

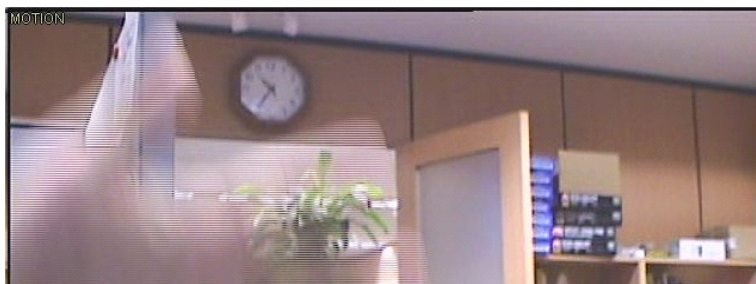
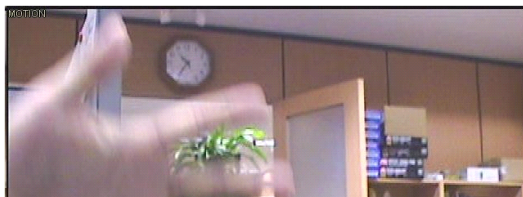

6.6 SEARCH OPTIONS OVERVIEW

The Search Options allows the user to find the requested images quickly, enhance the image quality, and export the video or images in a number of ways.

Index Search: Used to perform a search based on Motion detection and Sensor activation. Allows for quickly narrowing down large amounts of recorded video based on particular criterion.

Preview Search: Allows for narrowing down recorded video in a 24 Hour period. Each day is broken into 24 images, one image for each hour of the day. (The images are taken from the first second of each hour). When an image is selected, the 'hour' chosen is then broken down into 6 images, one image for every 10 minute increment. When a 10-minute increment image is selected, 10 images are displayed, one for every minute within the 10 minute period. From this point, the selected image can be applied to the Main Search.

Object Search: Used to specify a region on an image and perform a search based on any motion that has occurred within that region.

Status Search: Displays recorded video in a color coded format that allows easy selection of the portion of video you wish to play.

6.7 PERFORMING A BASIC SEARCH

There are several different types of searches that can be performed on the DVR unit. The most basic involves simply selecting the date, the time, the camera, and pressing play.

1. Select a date using the calendar.
2. Select a time by adjusting the hour and minute slide bars.
3. Select one or more cameras.
4. Press **Play**. Video can be played forwards, backwards, or frame-by-frame.

6.8 DAYLIGHT SAVINGS TIME

The DVR automatically adjusts for Daylight Savings Time changes. When the hour “jumps forward” no video is lost because an hour is simply skipped. However when the hour “falls back” there is a duplicated hour that under normal circumstances would be recorded over. The Honeywell Fusion DVR actually records both hours and allows you to select which hour to play if the need arises.

To access the “lost hour”:

1. From the Search screen, select the **Select Date** button.
2. Select the date when Daylight Savings time “lost” an hour. An option appears which says “Daylight Savings Time.”
3. To play back the “lost” hour, select the **Daylight Savings** option.
4. Select **OK** to confirm the date and begin playing the video using standard search features.

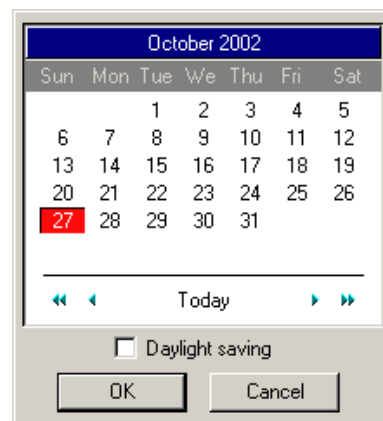

6.9 TIME SYNC

The Time Sync option synchronizes a single channel of video to playback in real time. Ordinarily the video may playback slower or faster depending on several factors, including how many PPS recorded and number of cameras playing at the same time.

In addition, the Time Sync option will be automatically enabled when an audio channel is selected inside Search.

1. Select a single image to synchronize by double-clicking on an image.
2. Select a channel of audio (optional).
3. Press the **Time Synch** button. The video will now playback in real time.

6.10 PRINTING AN IMAGE

The DVR can print a recorded image to a local or network printer.

1. From the Search screen, stop on the image to print. Double-click the image.
NOTE: Only one camera can be selected at a time for this function to work.
2. Click on the **Print** button. A Print Options window appears. Depending on the printer being used, there may be several printing options available. Refer to the printer manual for more information.
3. Press the **Print** button to print the selected images.

NOTE: The message "NO DEFAULT PRINTERS INSTALLED" will display if no printer is installed.

6.11 'SAVE TO' FUNCTION

The DVR unit can export single images in the .JPG file format, save video clips in the .AVI format, or output to a VCR using the s-video port. The JPG and AVI file formats are extremely common with virtually universal computer support making them ideal formats to use. A digital signature is also attached to every .JPG and .AVI file exported by the DVR for use with the bundled Digital Verifier application. This function is unique to the DVR and its Verification software and should not interfere with viewing the files using other applications.

JPG: The format (.jpg) is optimized for compressing full-color or grayscale photographic images. JPG images are 24-bit (16.7 million color) graphics. JPG is used to export a single image or frame.

AVI: AVI image data can be stored uncompressed, but it is typically compressed using a Windows-supplied or third party compression and decompression module called a codec. AVI files save a video clip.

Analog Out Sends a full screen video signal to the s-video port of the DVR. This feature is only available on DVRs with an s-video out.

6.11 SAVE TO FUNCTION, CONTINUED

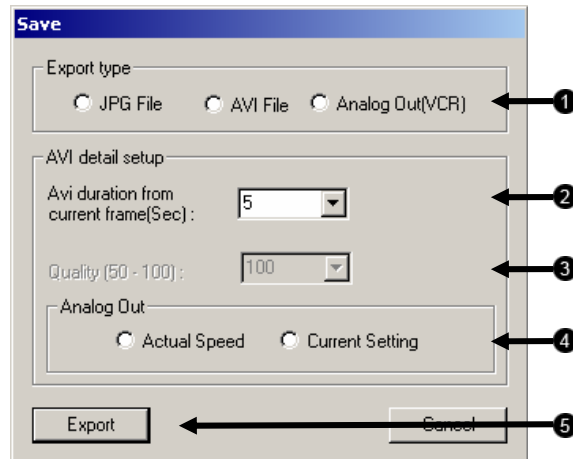

1	Export Type	Selects method used for export.
2	AVI Duration	Enter duration (in seconds) for recording the AVI file. Although 100 is the longest displayed, a manual time may be entered.
3	Image Quality	It may be necessary to reduce the overall size of an AVI file; for example, to email to someone. AVI file sizes can be reduced by reducing the image quality. By reducing the image quality, the AVI video appears more pixilated. When size is not an issue, setting quality to 100 is highly recommended.
4	Analog Out	Sets whether to export video in real-time or based on the Speed Bar setting in the Search Menu.
5	Export	The Export button begins the saving process. (Cancel closes the window without exporting.)

6.12 INDEX SEARCH

Using the **Index Search** can greatly decrease the amount of time spent searching through saved video. The Index Search allows a user to perform a search based on criteria such as Sensor, Motion and Instant Record events.

1	Select All Cameras	This option selects all cameras.
2	Multiple camera search	Select one or more cameras to search.
3	Select Time	The default search time is 24 Hours. If this option is select then a Start Time and End Time must be entered.
4	Start Time	Specifies the Start Time for the Index Search.
5	End Time	Specifies the End Time for the Index search.
6	Sort Option	Searches by the selected event: Sensor, Motion Detection, or Instant Record.
7	All Event	Searches on all events (sensor, motion, instant recording) for the selected camera(s).

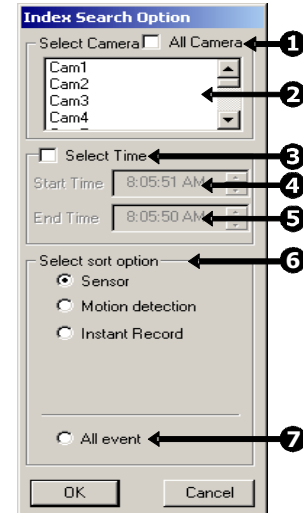

6.12.1 PERFORMING AN INDEX SEARCH

1. Select the **Index Search** button. The Index Search Option box will open.
2. Select a single camera or check the All Cameras option.
3. Select an event to search (sensor, motion, instant record) or select the All Event option.
4. Press **OK**. There may be a delay while results are returned. Results will be displayed in a column on the left side of the screen. If no results are found, "NO IMAGE FOUND" will appear in the column.
5. Once the results are displayed, double-click on any one to search through them.
6. Once the desired image is found, apply it to the Main Search by selecting the **Close** button at the bottom of the results column.

6.12 INDEX SEARCH, CONTINUED

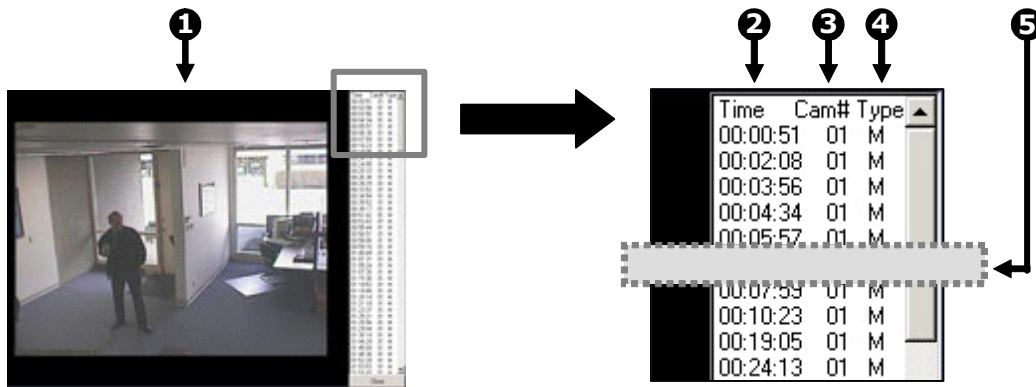

1	Image Display Area	Where Search results images are displayed.
2	Time	Time of the result.
3	Camera Number	Camera number of the returned result.
4	Type	Displays event type: M – Motion S – Sensor IR – Instant Record
5	Search Results	Displays the results of the search. Each line represents a segment of video.

6.13 PREVIEW SEARCH

The Preview Search can be used in a number of circumstances to quickly find an exact moment where an event, such as a theft, occurred. The Preview Search basically gives a 24 Hour visual overview of a single camera by separating a 24 hour period (1 day) into 24 images, one image for each hour of the day. The search can then be further narrowed down into ten minute increments and one minute increments by simply selecting one of the images displayed.

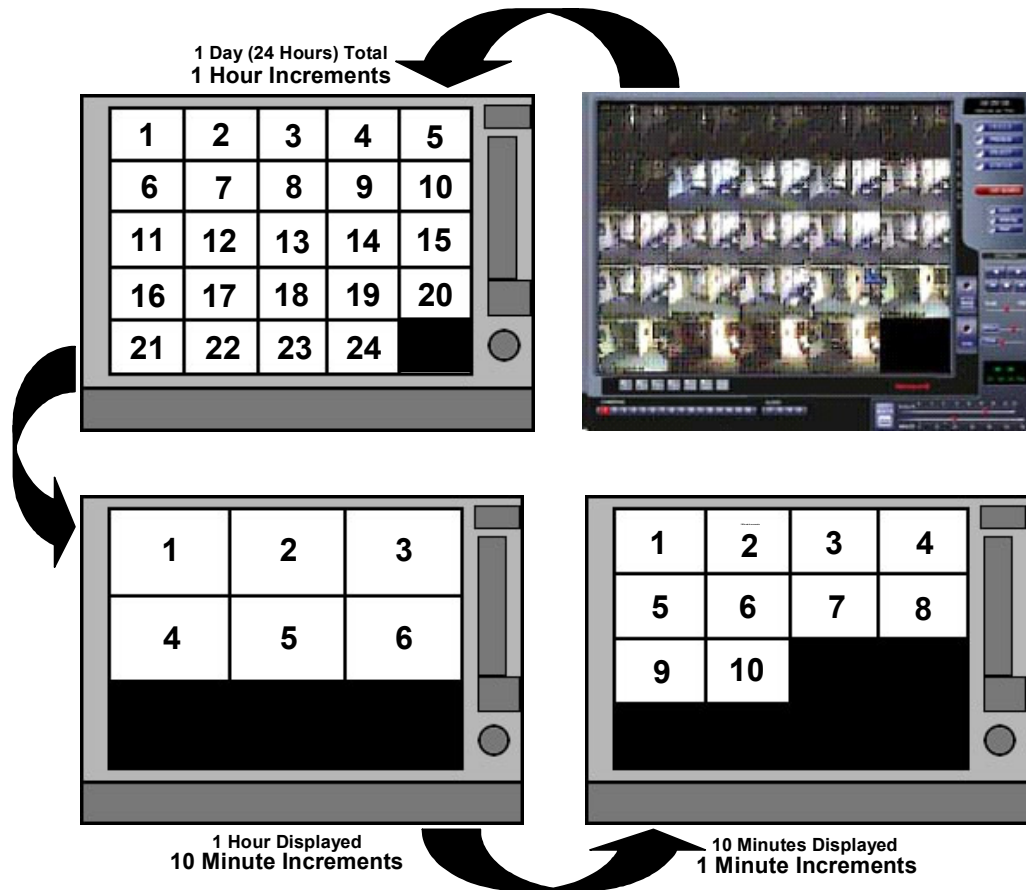

These example images show how the Preview Search functions. The first screen that appears has 24 images displayed. Each image represents the first second of each hour. If there is no image recorded during that period then nothing will be displayed. When an hour is selected (by double clicking on the image) then a new screen appears with 6 images. Each of these images represents a 10 minute segment of video. Once a 10 minute segment is selected (by double-clicking on the image) the final screen appears which breaks down that 10 minute segment into 1 minute increments (10 images).

6.13 PREVIEW SEARCH, CONTINUED

6.13.1 PERFORMING A PREVIEW SEARCH

1. Select a single camera, either by turning off all cameras but one or by double-clicking a displayed image.
2. Select the **Preview Search** button. 24 images display.
If there is no recorded video during a portion of the day, "No Image" will be displayed where the image should be.
3. Refine the search by double-clicking on an image to select it. 6 images display.
If needed, return to the previous 24 image view by right-clicking on an image.
4. Refine the search by double-clicking on an image to select it. 10 images display.
If needed, return to the previous 6 image view by right-clicking on an image.
5. Double-click an image to select the 1-minute segment of video to play.
A single image displays. If needed, return to the previous 10 image view by right-clicking on an image.
6. Use the Play controls to play the video of the selected segment.
7. To exit out of the Preview search with the current image still selected, deselect the **Preview Search** button.

6.14 OBJECT SEARCH

Object Search is a powerful Search utility that is used to search a region on the video for any motion changes. The Results are neatly displayed and can be viewed quickly.

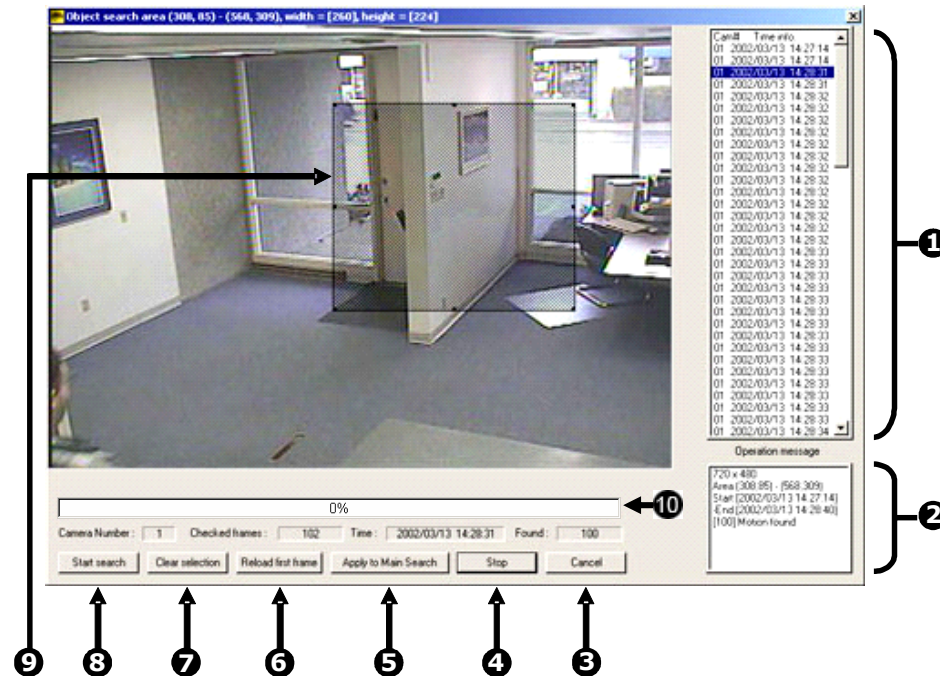

1	Search Results	Search results are displayed in this column and listed by date and time. When the search is complete, results can be viewed by double-clicking on one of the results or by using the Up and Down arrow keys on the keyboard.
2	Search Information	Displays brief information on the overall search.
3	Cancel	Exits the Object Search.
4	Stop	Stops the current search.
5	Apply to Main Search	Exits the Object Search but takes the selected result (currently displayed image) and displays it inside the Main Search. From that point, play controls can be used.
6	Reload First Frame	Reloads the initial key frame image (the image used to start the search).
7	Clear Selection	Clears the current motion region box from the key frame image.
8	Start Search	Begins the search.
9	Motion Region Box	The user-defined area of the key frame image. Create the motion region box by clicking inside the image and dragging the mouse. The motion region box can be resized by pulling on the small square boxes located on the outer perimeter of the box.
10	Status Bar	Indicates progress of search being performed.

6.14 OBJECT SEARCH, CONTINUED

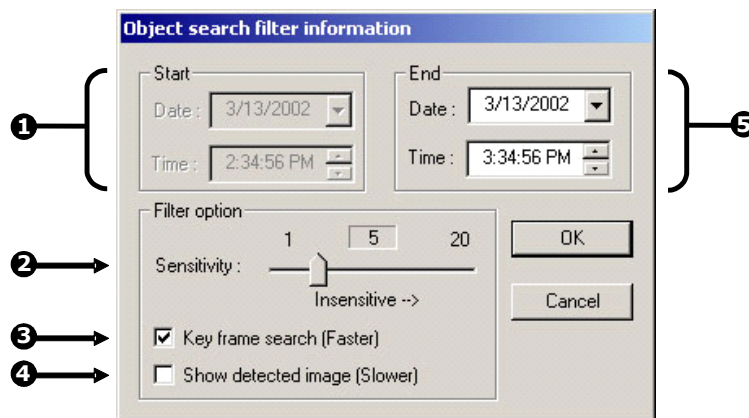

1	Start	Displays the time and date of the initial key frame.
2	Sensitivity	Used to control sensitivity of the motion to be detected. Poor lighting conditions can often be interpreted as motion; the sensitivity setting can compensate for this.
3	Key Frame Search	Searches by key frame.
4	Show Detected Image	Displays the results as they are found. Using this option slows the search process slightly and therefore may not be ideal when searching large periods of time.
5	End	Used to designate an end time. (Default is 1 hour.)

6.14.1 PERFORMING AN OBJECT SEARCH

1. Select a single camera, either by turning off all cameras but one or by double-clicking a displayed image.
2. Select the **Object Search** button.
3. Create a motion region box on the image by clicking inside the image and holding down the left mouse button while dragging the pointer. When the desired shape is created, let go of the mouse button. Only one motion region box can be created. To delete the motion region box, press the **Clear Selection** button.
4. Press the **Start Search** button. The Object Filter Search information should open.
5. Select an end time. One hour is the default setting.

6.14 OBJECT SEARCH, CONTINUED

- Adjust the sensitivity if necessary.
- Click **OK** to begin the search. When results are found, they will be displayed in the column to the right. If no results are found, the search will end and “No Images Found” will display in the column. Press **Stop** to stop a search.
- When the search has ended, double-click on one of the results. Use the up and down arrows to scroll through the results quickly.
- When the desired image is found, select **Apply to Main Search** to use the play controls.

6.15 STATUS SEARCH

The Status Search option displays video in graph format.

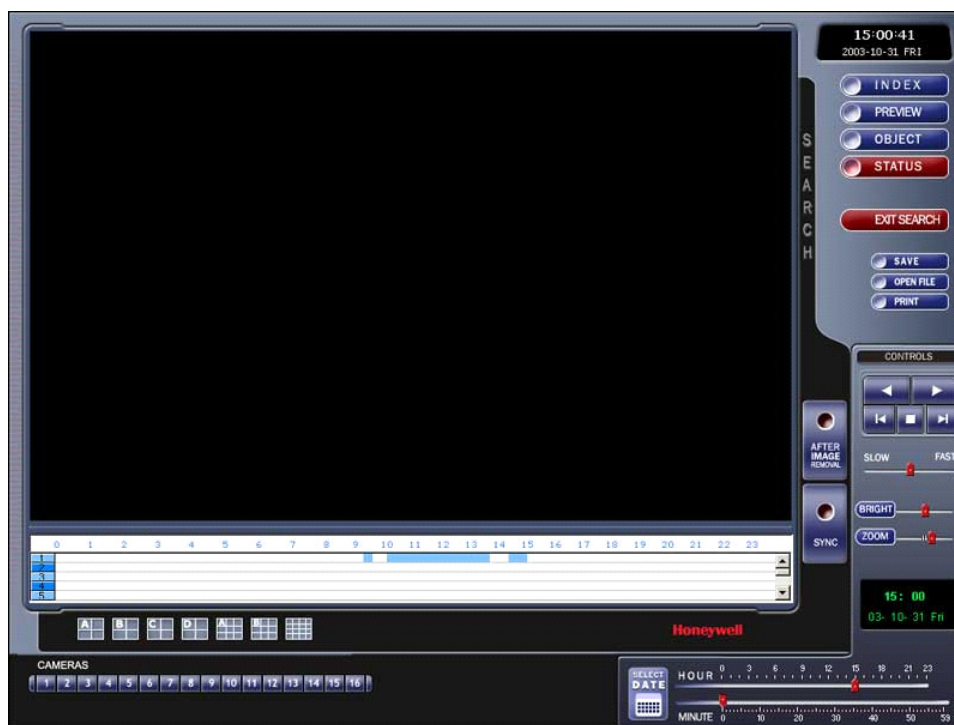

6.15 STATUS SEARCH, CONTINUED

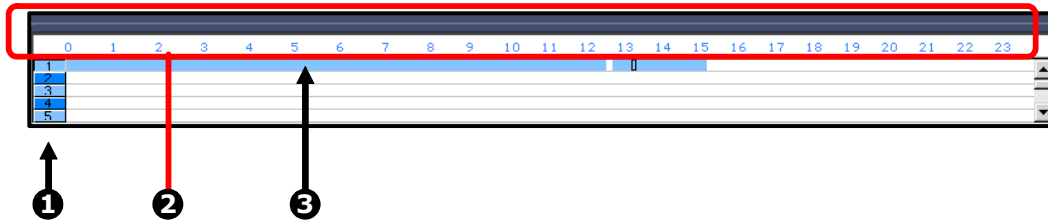

1	Camera	Displays the cameras in linear format. Scroll down using the scroll bar on the right.
2	Hours	The hours 0-23 (24 hours) are listed.
3	Recording Block	Displays in blue where video is recorded. Areas of no recording are displayed in white.

6.15.1 PERFORMING A STATUS SEARCH

1. Select the **Status Search** button to open the Status Search window.
2. Use the mouse to click on an area of the blue recording block.
Only one camera can be displayed at a time.

6.16 AUDIO

Audio is played back at 48,000Hz.

To play audio with the video:

1. Select a single camera by turning off all cameras but one using the **Camera Select** buttons. The audio buttons will be displayed.
2. Select a single audio channel to play. When an audio channel is selected, the **Time Sync** button will automatically be selected.
3. Press the **Play** button.

6.17 POINT OF SALE (OPTIONAL)

The Point of Sale search is an optional component that can be added to the Fusion DVR. When installed and activated, a POS button will appear inside the Search Window.

The POS functionality utilizes TVS technology. When performing a POS search, a TVS window appears allowing multiple options and criteria for detailed searches.

The POS capability provides the following functions:

- Perform detailed queries based upon large criteria selections.
- Chart results in a graphical format.
- Instantly view video from POS queries.
- Access and Search POS data from a remote location. (Requires additional software that can be purchased from TVS)
- Interface with most POS interfaces
- Interfaces with a large selection of ATM Devices.

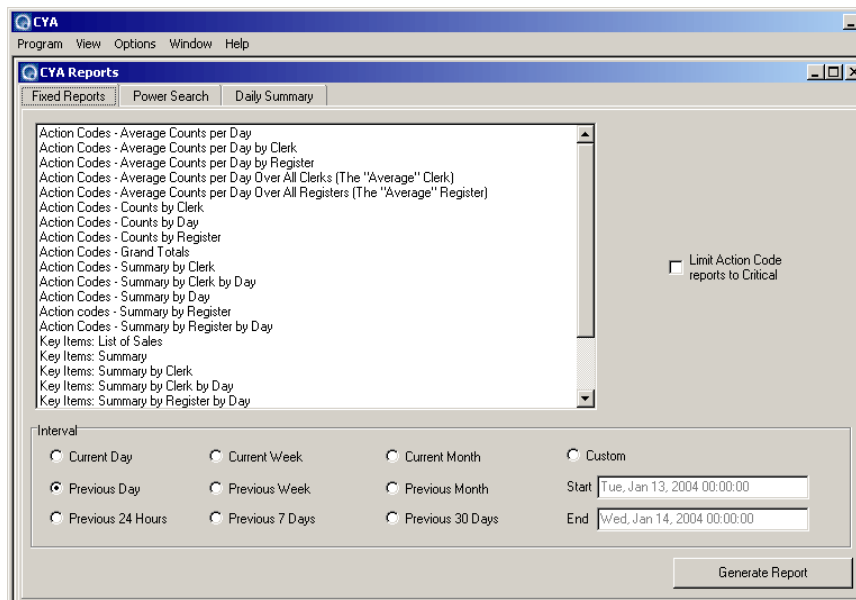

The basic premises of a POS search is as follows:

1. Open Search and press the POS Search button.
2. When the CYA window appears enter your search criteria and press the **Generate Report** button.
3. When the results are displayed, simply double-click on a result to display the result in the main Search window.
4. Now play the video, export the video, or perform another advanced search.

Contact your sales representative for more information on adding POS capability.

SECTION 7 PAN / TILT / ZOOM

7.1 PAN / TILT / ZOOM OVERVIEW

The PTZ controls within the DVR unit allow for powerful control over the cameras. This can be extremely beneficial by increasing the usefulness of the recorded video. Use the PTZ controls to create custom preset configurations that can continuously sweep across large areas.

7.2 SETTING UP A PTZ CAMERA

Setting up a PTZ Camera is simple since the DVR unit comes preassembled with an internal RS-485 adapter.

RS-485 ADAPTER	
RED	Positive (TX+)
WHITE	Negative (TX-)

1. Locate the PTZ adapter.
(Refer to Section 3.1 for assistance identifying the adapter.)
2. Connect the two wires of the PTZ adapter to the PTZ camera. The red wire on the adapter should connect to the RX+ on the PTZ and the white wire should connect to the RX-.
3. Connect the other end of the adapter to the DVR unit as shown
4. Assign the PTZ camera an ID number that coincides with the number assigned to it by the DVR unit.
Example: If the camera's video is connected to input number 5, set the PTZ unit to ID number 5.
5. Inside the DVR setup, select the PTZ camera using the Camera Selector buttons.
6. Enable the PTZ functions of the camera by placing a check in the **Pan/Tilt Connection** checkbox.

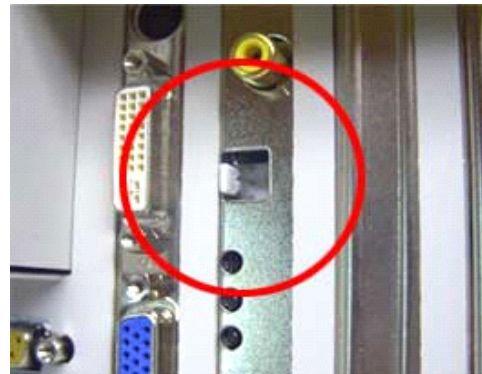

7.2 SETTING UP A PTZ CAMERA, CONTINUED

7. Once enabled, the Protocol can be edited. Select the appropriate Protocol.

NOTE: Protocols are a set of instructions written by the manufacture of the PTZ cameras that allow software programs such as this DVR to control their functions. The majority of the major PTZ manufacturer protocols are included in this software.

8. Press **Apply** and exit Setup.

9. From the Main Display Screen select the **PTZ button** (See Section 4.3 – Display Screen.) The PTZ Control options open.

10. Select the **PTZ camera** to control by clicking on its video on the main display screen. The camera number will appear inside the PTZ controls.

11. Using the PTZ controls, you should now be able to move the PTZ around.

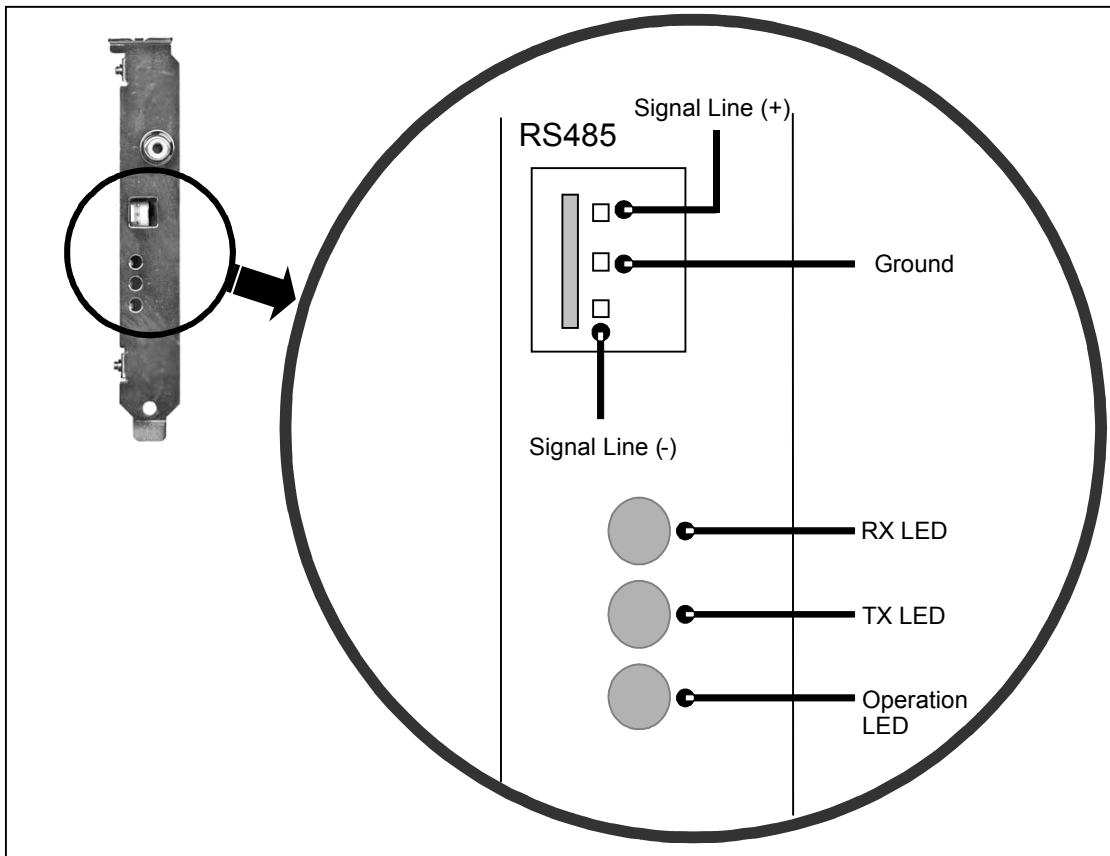

7.2 SETTING UP A PTZ CAMERA, CONTINUED

7.2.1 SUPPORTED PROTOCOLS

Protocols are added frequently. The supported list may contain new protocols that are not listed here.

The current supported protocols are:

Ademco Rapid Dome	KDC
American Dynamics	LG (LVC-A70x's)
CBC (GANZ)	LG SD-110
C-BEL	LG (LPT-A100L)
Chiper CPT (V9KR Series)	Merit LI-LIN
CNB-AN102	NiceCam
CNB-PTZ100	Panasonic
Computar	Pelco D
Dong Yang Unitech (DRX-502A)	Pelco (P protocol 4800bps)
Dennard	Philips (TC8560 & TC700)
Dynacolor	SAE
Ernitec	Samsung (DRX-502A)
Fastrax II	Samsung (SCC-641)
FilTech (DSC-230/PT-201)	SANTACHI
Fine System (CRR-1600)	Sensormatic SpeedDome
Focvision (KD1602)	SungJin (SJ2819RX)
HMS-250	Toshiba (P protocol 4800bps)
HSCP	Ultrak (KD6)
Honeywell (HSD-250)	VCL
Inter-M(VRX-2101)	VCL- LEGACY
Javelin (Orbitor)	Vicon
Kalatel (Cyber Dome)	Vicon Surveyor 2000
	Videoalarm
	WonWoo

7.3 ADVANCED PTZ SETUP

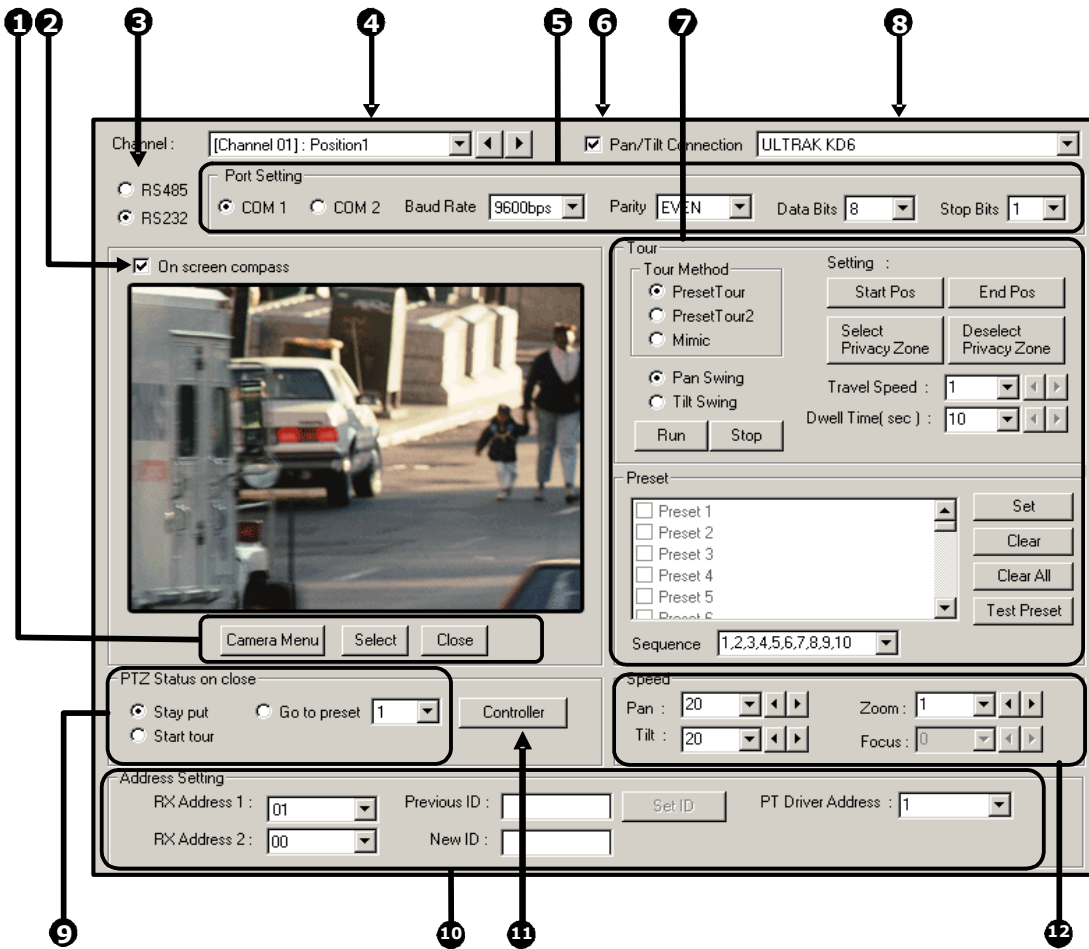

7.3 ADVANCED PTZ SETUP, CONTINUED

1	Camera Menu	Opens the OSD PTZ camera menu.
2	On-Screen Compass	Allows On-Screen control of a PTZ camera.
3	RS-232 / RS-485	Defines how to send the PTZ signal to the camera.
4	Select Camera	Selects the current camera to be edited.
5	Port Settings	Defines the specific settings to transmit to the PTZ.
6	Enable Pan/Tilt	Enables the DVR to control the PTZ camera.
7	Preset and Tour	Used to create Presets and Tours for the PTZ camera. Since each camera creates these in a different way, there can be multiple methods.
8	Protocol	Selects the protocol to use for the selected camera. The protocol is the unique set of instructions that allows the DVR to communicate with the PTZ camera.
9	PTZ Status on Close	This option will activate a Tour or Preset when the PTZ controller is closed.
10	Address Setting	Only available on select PTZ cameras. These options need to be set when there are more PTZ cameras connected together than there are inputs on the DVR. Setting these options allows for attaching several DVRs to the PTZ chain.
11	Open PTZ Controller	Opens the PTZ controller, allowing the PTZ camera to move.
12	Pan Speed	Increases or decreases the Pan speed.
	Tilt Speed	Increases or decreases the Tilt speed.
	Zoom Speed	Increases or decreases the Zoom speed.
	Focus Speed	Increases or decreases the Focus speed.

7.4 CREATING AND VIEWING PRESET POSITIONS

A Preset Position is a user-defined location where the camera can be pointed, zoomed in, and focused. Preset positions can be defined and labeled if the camera supports this. Each preset can have an independent Dwell and Speed setting for use with the Tour 2 Function.

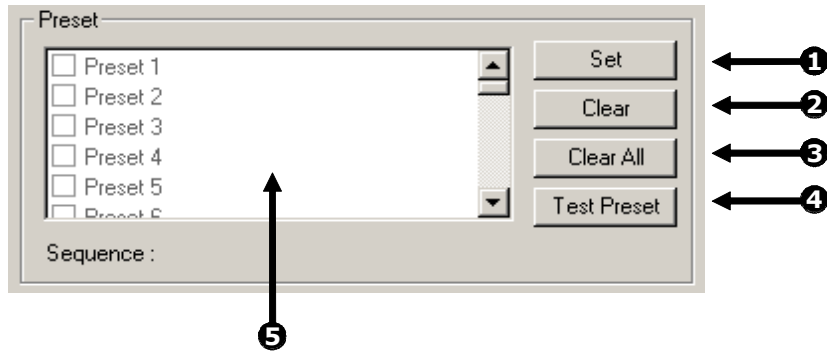

1	Set	Once a preset is selected, the Set button records the preset position.
2	Clear	The Clear option deletes the selected Preset.
3	Clear All	This option deletes all Preset Positions.
4	Test Preset	This option tests a selected Preset Position.
5	Preset Positions	This displays the Preset Positions. If a preset is currently used, a check will be placed in the box next to its name.

7.4.1 CREATING A PRESET

1. Inside **Setup**, select the PTZ setup option and the camera to edit.
2. Inside the Preset options select a Preset you would like to modify (a red box will appear around the Preset).
3. Use the Pan/Tilt/Zoom/Focus controls to move the selected camera to the desired position.
4. Enter a Dwell Time and Speed setting. This is used for the Tour 2 function (Each Preset can have a different Dwell and Speed setting).
5. Once the camera is in the desired position, press the **Set** button.

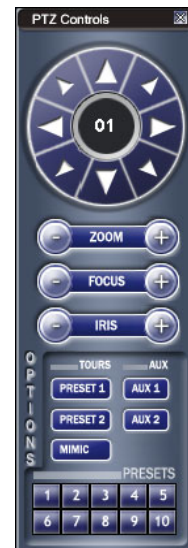

7.4 CREATING AND VIEWING PRESET POSITIONS, CONTINUED

6. A window will open for entering a Preset Name. Enter a name and press **OK**.

7.4.2 VIEWING A PRESET

1. From the Main Display Screen, click on the PTZ camera to select it.
2. Using the keyboard, press the number keys corresponding with the Preset positions. The camera will move to the saved Preset.
3. Presets can also be activated using the on-screen PTZ controller. Open the controller and press a preset button.

7.5 UNDERSTANDING TOURS

The following section explains the PTZ Tour options. Since there are many PTZ manufactures with several different ways of operating Tours, we have tried to accommodate the most popular protocols. Not every Tour Method will be available for each PTZ camera.

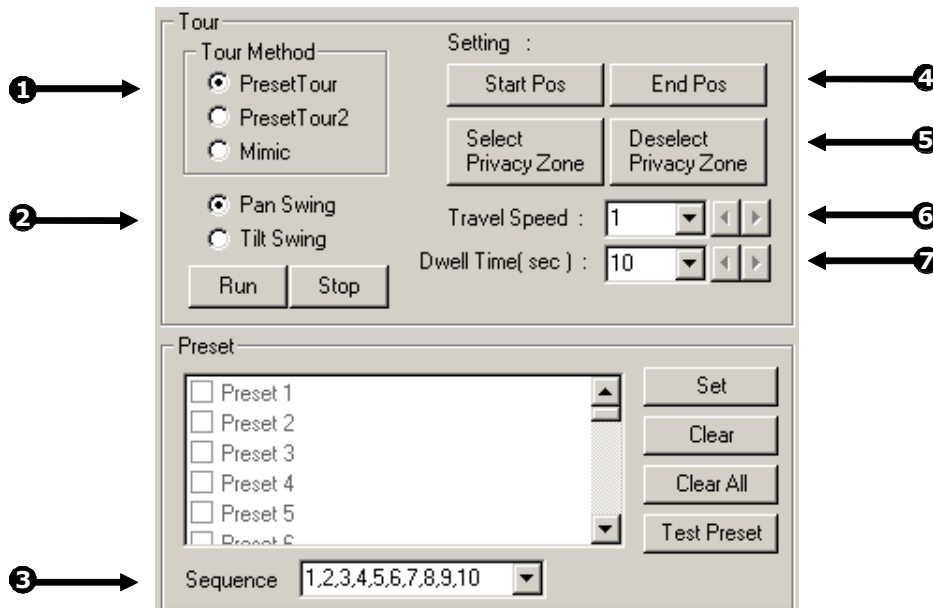

7.5 UNDERSTANDING TOURS, CONTINUED

1	Tour Method	These options define the type of Tour to use.
	Preset Tour	The Preset Tour cycles through recorded Presets. For Ex. If Presets 1,2,4,6 and 9 are defined, then the Tour will cycle as such... 1,2,4,6,9,1,2,4,6,9,1,2...etc. The default cycle time is 5 seconds.
	Preset Tour 2	This option works the same as the standard Preset Tour with the addition of a definable Travel Speed and Dwell Time. The Dwell and Travel speed can be defined for each preset by accessing and setting these options in the PTZ camera menu.
	Mimic Tour	This Tour 'mimics' a user-defined motion path, copying everything the user does (including speed).
2	Pan Swing/ Tilt Swing	This option enables the Horizontal (Pan) or Vertical (Tilt) 'Guard Tours'.
3	Sequence	This is a Tour method that allows a user to select a Preset Sequence from a Drop-Down list. This list is only displayed on supported Protocols.
4	Start/Stop Position	These options describe how to define a Mimic Tour. The Start Position button begins the 'recording' process. The Stop Position button ends it.
5	Privacy Zone	The Privacy Zone is a definable area that is masked out so it cannot be viewed.
6	Travel Speed	This option defines the speed at which a PTZ moves from one Preset position to the next (when using Preset Tour 2).
7	Dwell Time	This option defines the length of time (in seconds) that a PTZ Tour stays on a Preset Position. Moves from one Preset position to the next (when using Preset Tour 2).

7.5 UNDERSTANDING TOURS, CONTINUED

7.5.1 CREATING A PRESET TOUR

1. Start by creating two or more Preset Positions. (refer to Section 7.4.1)
2. Select the **Preset Tour** Method. The Preset Tour is now the default Tour method.
3. The Tour is now set to cycle through the defined presets.

7.5.2 VIEWING THE PRESET TOUR

1. From the Main Display Screen, select the PTZ option.
2. Select the PTZ camera of the Tour you just created.
3. Press the Tour Button. The Preset Tour will activate.

7.5.3 CREATING A PRESET TOUR2

1. Start by creating two or more Preset Positions. (refer to Section 7.4.1)
2. Select the **Preset Tour2** Tour Method. The Preset Tour is now the default Tour method.
3. The Tour is now set to cycle through the defined presets at the specified Travel Speed and Dwell Time defined by the preset tour that is selected in the PTZ setup menu.

7.5.4 VIEWING THE PRESET TOUR2

1. From the Main Display Screen, select the PTZ option.
2. Select the PTZ camera of the Tour you just created.
3. Press the Tour Button. The Preset Tour2 will activate.

7.5 UNDERSTANDING TOURS, CONTINUED

7.5.5 CREATING A MIMIC TOUR

1. Select the **Mimic Tour** Method.
2. Press the **Start Position** button.
3. Using the PTZ Controller, move the PTZ in the path of the tour to mimic.
4. Press the **Stop Position** button when finished moving the PTZ around.
5. Press **OK** or **APPLY** to save.

7.5.6 VIEWING THE MIMIC TOUR

1. From the Main Display Screen, select the PTZ option.
2. Select the PTZ camera of the Tour you just created.
3. Press the Tour Button. The MIMIC Tour will activate.

7.6 PTZ STATUS ON CLOSE

The **PTZ Status on Close** is an option that defines the default settings for a PTZ camera when the controller is not open. This includes activating a Tour, moving to a preset position or simply leaving the camera as it.

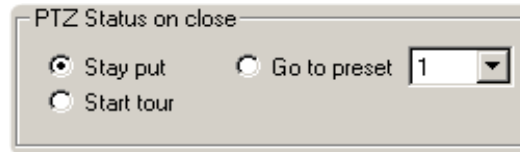

Stay Put	This option leaves the PTZ in its present state.
Start Tour	Starts the Pre-Defined Tour function when the on-screen PTZ controller is closed. The Tour that will be activated will be the Tour that is selected.
Go To Preset	Moves to a Selected Preset position when the on-screen PTZ controller is closed.

7.6.1 ACTIVATING THE PTZ STATUS ON CLOSE OPTION

1. Start by creating a Preset or Tour for the selected camera.
2. Select either **Start Tour** or **Go To Preset**.
3. Press **OK** or **APPLY** to save.

7.7 PTZ ADDRESS SETTING

Some protocols support software address settings. The following section explains these settings.

The screenshot shows a dialog box titled "Address Setting". It contains the following elements:

- RX Address 1: A dropdown menu with "01" selected.
- RX Address 2: A dropdown menu with "00" selected.
- Previous ID: An empty text input field.
- New ID: An empty text input field.
- Set ID: A button.
- PT Driver Address: A dropdown menu with "1" selected.

RX Address 1	This option was added for a particular line of receivers that support 2 ID addresses. This is the first RX address.
RX Address 2	This option was added for a particular line of receivers that support 2 ID addresses. This is the second RX address.
Previous ID	This option was added for a particular line of receivers that support 2 ID addresses. This option displays the current RX address ID.
New ID	This option was added for a particular line of receivers that support 2 ID addresses. This option is for entering a new RX address ID.
Set ID	This option was added for a particular line of receivers that support 2 ID addresses. This option is for setting the new RX address.
PT Driver Address	This option is for specifying the PTZ ID address that the PTZ is set to. This option must be set correctly in order for the DVR to communicate with the PTZ. This option can be beneficial when large amounts of PTZ are chained together.

7.7.1 ACTIVATING THE PTZ STATUS ON CLOSE OPTION

1. Start by creating a Preset or Tour for the selected camera.
2. Select either **Start Tour** or **Go To Preset**.
3. Press **OK** or **APPLY** to save.

7.8 ACCESSING PTZ MENU'S

Some protocols support the ability to access the Internal PTZ Onscreen Menu.



Camera Menu	This option opens the PTZ Camera menu.
Select	This option selects an item on the Onscreen menu.
Close	This option closes the PTZ Onscreen menu.

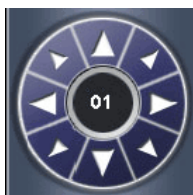

Up/down	The Up and Down buttons on the PTZ controller move through the PTZ menu options.
Left/Right	The Left and Right buttons on the PTZ controller move through the PTZ menu options and/or highlight options.

Since every PTZ camera is different, the functions of these options can vary slightly.

The Fusion DVR provides an easy way to access the cameras options. For explanations of what those options are please refer to the manual that came with your camera.

7.8.1 OPENING AND EDITING THE KD6 MENU

1. Start by pressing the **Camera Menu** button.
The camera menu will appear on the video.
2. Use the Up and Down buttons on the PTZ controller to scroll through the menu options.
3. Press the **Select** button to select a menu option.
Pressing Select will either scroll one menu deeper or it will change a selected option.
4. Press **Close** to scroll one menu back, or if you are at the root menu level, it will close the PTZ menu.

7.9 USING THE ON-SCREEN CONTROLLER AND COMPASS

The Fusion DVRs provide control for the PAN/TILT camera in two different ways.

1. Using the Graphical PTZ controller that appears when the PTZ button is pressed on the main screen.
2. Clicking on the video itself. This second option is a much more powerful way to control the Camera. (**NOTE:** The PTZ button on the main screen must also be selected to use this option.)



Control the PTZ by dragging the mouse on the screen in the desired direction. A green line will appear to show the direction the PTZ will move. The shorter the line the shorter the PTZ will move. The longer the line the longer the PTZ will travel in the specified direction.

7.9 USING THE ON-SCREEN CONTROLLER AND COMPASS, CONTINUED

7.9.1 THE PTZ CONTROLLER

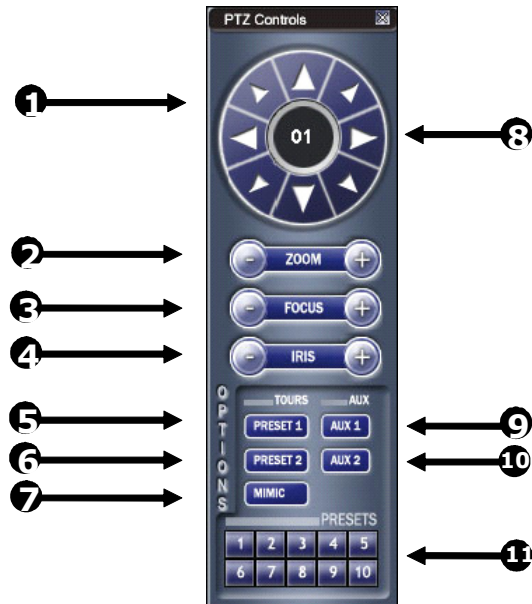

1	Direction Controls	There are 8 directions buttons that move the PTZ. NOTE: Only 4 of the buttons work for all protocols (UP, DOWN, LEFT, RIGHT). 8 Directions are available only for select protocols.
2	Zoom	This option Zooms the camera in and out.
3	Focus	This option Focuses the PTZ camera.
4	Iris	This option adjusts the Iris on the PTZ.
5	Preset 1 Tour	This option activates the Preset 1 Tour .
6	Preset 2 Tour	This option activates the Preset 2 Tour .
7	Mimic Tour	This option activates the Mimic Tour .
8	Camera Number	This displays the camera number you are currently controlling. To change the camera, simply click on the video of the camera you wish to control.
9	Aux 1	This option activates a different option for each protocol.
10	Aux 2	This option activates a different option for each protocol.
11	Preset Controls	These buttons activate the corresponding PTZ Preset.

7.9 USING THE ON-SCREEN CONTROLLER AND COMPASS, CONTINUED

7.9.2 AUX BUTTONS

The AUX buttons activate different options for each protocol. The protocols and their options are defined below.

VCL, Ademco Rapid Dome, Javelin (Orbitor), KD6	AUX 1	Auto Iris
	AUX 2	Auto Focus
Pelco-D, Pelco-P, Kodicom Receiver, CBC, Dennard KD6	AUX 1	Wiper
	AUX 2	Light

SECTION 8

BACKING UP TO A CD-R DRIVE

8.1 BACKUP OVERVIEW

The DVR unit can easily backup important video to an internal or external media location. The most commonly used are CD-RW drives and Hard Drives. Since the DVR unit comes standard equipped with a CD-RW drive, this section covers backing up using the CD-RW drive as well as by using a Hard Drive.

The DVR unit backs up using a proprietary compression format that can only be read by the DVR Backup program. This ensures the integrity of the data. In addition the CD-RW also uses a proprietary format in which it stores the information. This format, called UDF, can only be read by a Computer which has the UDF reader software installed. A copy of Roxio® UDF Reader is on the Software Installation CD shipped with the DVR unit. A copy is also available for download from Roxio® direct (<http://www.roxio.com>).

During the backup process the DVR unit will never stop recording. The DVR unit is a multiplexing unit that can perform virtually all functions without having to stop the recording process.

In addition, you can now backup to multiple CDs when the file sizes exceed the size of one CD. Also, you can specify multiple locations to save to. For example you can save 1/3 the data to a CD, 1/3 the data to the local Drive and 1/3 the data to a network drive.

8.2 DirectCD FORMAT UTILITY

The Fusion DVR unit uses DirectCD® 5.0 to save the data to a CD-RW Drive. This allows the DVR to use the CD-RW just as it would any other attached Hard Drive, both reading and writing to it. CDR and CD-RW discs must be formatted in the DirectCD 5.0 UDF standard for the DVR unit to recognize them. It is recommended that CDR discs, NOT CD-RW discs, be used in the DVR unit only because of the format time and cost difference between the two. It can take 45 minutes to an hour to format a CD-RW disc but only 15 to 30 seconds to format a CDR disc. In addition, CDR discs are generally considerably less expensive than CD-RW discs.



There are two ways to open the DirectCD format utility. The first is by exiting to windows. The second is by opening the Backup Window and pressing the **Format CD** button.



CAUTION: Although many features are available within DirectCD, it is highly recommended that you do NOT use any features other than those necessary for the standard exportation of video as outlined in this section, otherwise loss of information or software instability could result.

8.2 DIRECTCD FORMAT UTILITY, CONTINUED





1	Windows Control Buttons	<ul style="list-style-type: none">  Calls the Help screen.  Minimizes the window  Closes the DirectCD application
2	CD Select	Use the dropdown box to choose the CD-RW drive attached to the DVR. Generally, this defaults to the correct CD-RW drive.
3	CD Utilities	Used to perform repairs on CDs that have become unstable or failed completely.
4	Format CD	Used to format a CD or CD-RW so that it can be read by the DVR.
5	Eject CD	Used to remove the CD from the drive after specifying how to end the recording session.
6	Options	Used to adjust options pertaining to the operation of DirectCD.
7	Help	Opens the DirectCD help file.

8.3 FORMATTING A CDR OR CD-RW DISC



We strongly recommend using CDR discs rather than CD-RW discs. CD-RW discs can take up to 30 minutes or more to format and may have compatibility issues.

1. Insert a blank CDR or CD-RW disc into the CD-RW drive.
2. Enter **Backup** and click the  button.
3. Press the  button. The CD begins formatting.
A CDR disc will take anywhere from 15 to 30 Seconds to format and a CD-RW disc will take anywhere from 45-60 Minutes.
When finished, Direct CD will indicate it is ready for reading and writing.
4. Close the DirectCD window to return to **Backup**.

8.4 GENERAL BACKUP OPTIONS OVERVIEW

The BACKUP OPTIONS window offers the selection of the video you wish to save and also the location of where to save it.

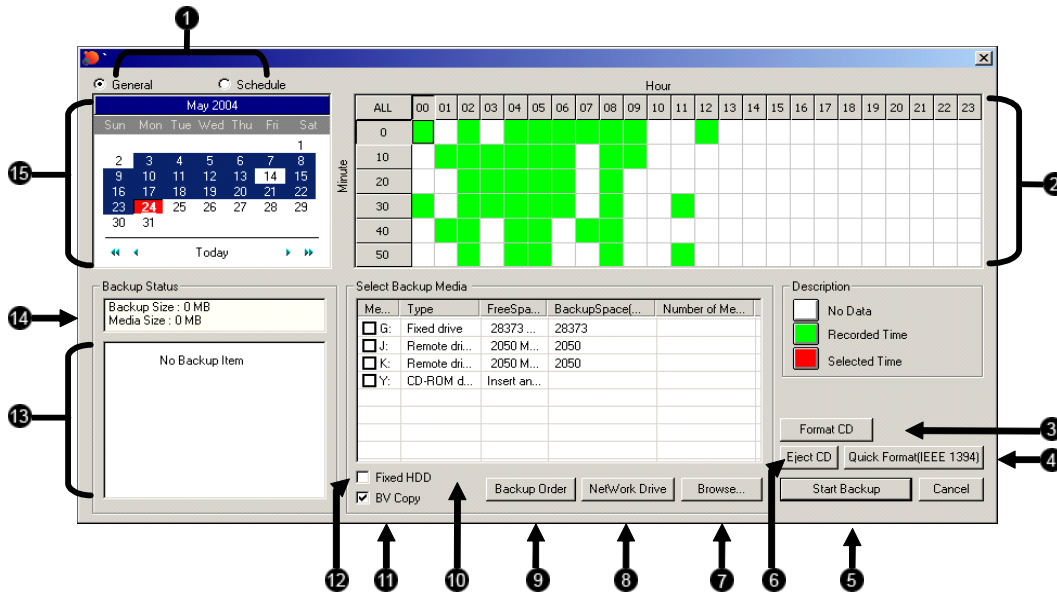

1	General / Schedule	Switches between the General Backup window and the Scheduled Backup window.
2	Hour/Minute	Displays a 24 hour time period in 10 minute increments. Color coded boxes represent "No data," "Recorded data," or "Selected data." Select a time by clicking on one of the boxes; deselect it by clicking on it again.

3	Format CD	Opens the CD formatting Utility (see the Formatting a CD-R or CD-RW section in this chapter).
4	Quick Format IEEE (1394)	Performs a quick format of the attached IEEE (1394) device.
5	Start Backup	Once the location and video have been selected, this button begins the backup process.
6	Eject CD	Ejects the CD from the connected CD Burner.
7	Browse	Used to select a location for saving the video.
8	Network Drive	Used to connect to a drive over a network.
9	Backup Order	Used to specify the order in which multiple drives are used to record backup video to.

8.4 GENERAL BACKUP OPTIONS OVERVIEW, CONTINUED

10	Select Backup Media	Displays available storage drives. Use this window to select the drive you wish to save video files to.
11	BV Copy	Copies the proprietary viewer onto the CD-R and makes the CD autoplay.
12	Fixed HDD	By checking this box, all available hard drives (including mapped drives) will be displayed inside the SELECT BACKUP MEDIA box.
13	Backup Items	Displays the dates and times of events currently selected to backup.
14	Backup Space	Displays the currently available drive space for backup and the current file size of items selected for backup.
15	Select Day	Provides a calendar used to select the day. If video is recorded on a given day, the day will be highlighted. The current day is always highlighted in red.

8.5 SCHEDULED BACKUP OPTIONS OVERVIEW

The SCHEDULED BACKUP OPTIONS window allows the creation of a scheduled daily backup of selected times to a specified storage location.

NOTE: Available storage locations exclude CD-R and CD-RWs and are limited to hard disks specifically identified as backup space (see the specifying scheduled backup drives section in this chapter).

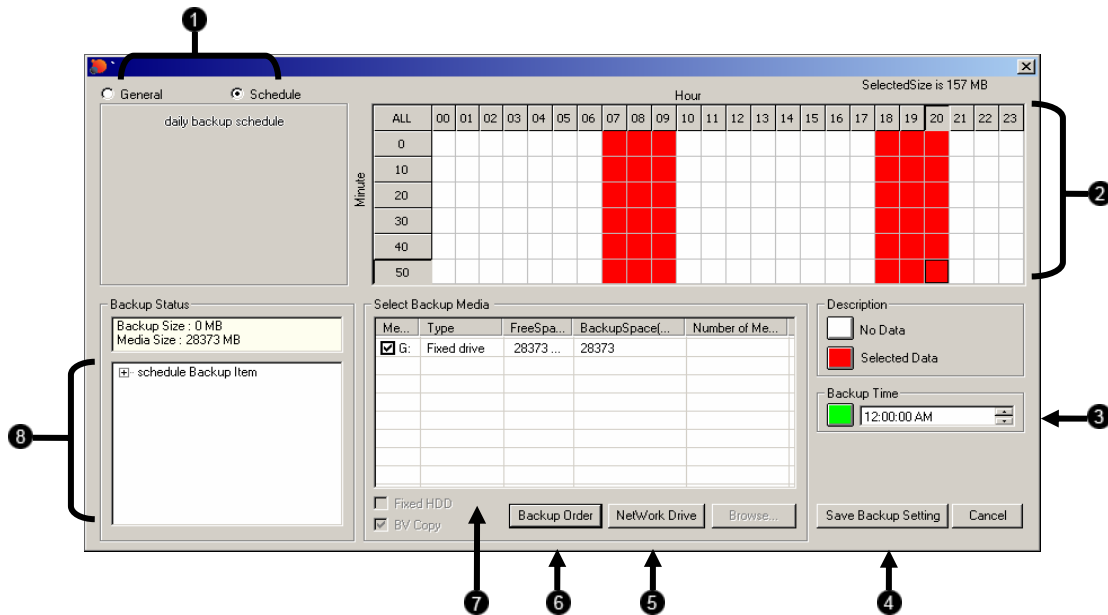

1	General / Schedule	Switches between the General Backup window and the Scheduled Backup window.
2	Hour/Minute	Displays a 24 hour time period in 10 minute increments. Color coded boxes represent “No data,” “Recorded data,” or “Selected data.” Select a time by clicking on one of the boxes; deselect it by clicking on it again.
3	Backup Time	Specifies at what time the Backup Schedule is executed.
4	Save Backup Setting	Saves the current settings for scheduled backup. The current recording schedule if any will now be executed daily.
5	Network Drive	Used to connect to a drive over a network.
6	Backup Order	Used to specify the order in which multiple drives are used to record backup video to.
7	Select Backup Media	Displays available storage drives. Use this window to select the drives you wish to save video files to.
8	Backup Items	Displays the dates and times of events currently selected to backup.

8.6 SPECIFYING SCHEDULED BACKUP DRIVES

In order to use the Scheduled Backup feature one or more storage drives or partitions connected to the DVR must be labeled as a backup drive.

1. Exit and restart in Windows mode.
2. Double click the **My Computer** icon on the DVRs desktop. A file menu will be displayed.
3. Right click on the drive you wish to specify as a backup drive for Scheduled Backup and select rename. Rename the drive to 'Backup'. Repeat this process for all drives you wish to use for Scheduled Backup. To remove a drive from use for Scheduled Backup, change its name back to DVR.

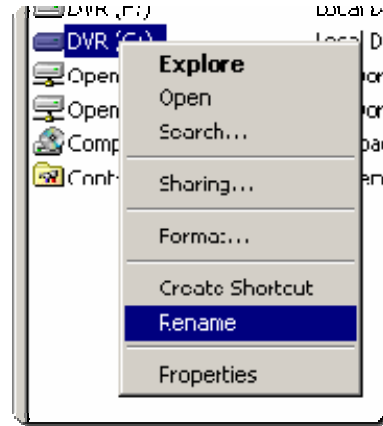

4. Restart the DVR and return to the Scheduled Backup window.

8.7 CREATING A SCHEDULED BACKUP

1. Enter **Backup** and select the **Schedule** radio button at the top of the window.
2. Select the times to backup by clicking on the desired blocks. The blocks will turn red when selected. Click a block again do deselect it.
3. Set the time to run Scheduled Backup in the provided space under Backup Time.
4. Specify the drive or drives to save the backup video to and set backup order.
5. Click . The window will automatically save and close.

NOTE: Only one daily Scheduled backup is allowed. To overwrite the existing schedule simply reenter the Scheduled Backup window set a new schedule and save.

8.8 BACKING UP TO A CD-RW DRIVE OR HARD DRIVE

1. From the Main Display Screen select the **BACKUP** button. The **Backup Options** window displays.
2. From the **Backup Options** window, use the calendar to select a date.
3. Select the time(s) to backup by clicking on the desired blocks. The blocks will turn red when selected. To deselect the blocks, click on them again.
4. To backup to CD media, insert a blank CD and follow the instructions for formatting a blank disk outlined in this chapter. Click on the corresponding CD-R/W drive that is displayed inside the **Select Backup Media** box and when prompted indicate the number of CDs needed to store the backup video (e.g. 980MB of video / 600MB of storage per disk = 1.63 so 2 disks would be needed) . Click the button.

To backup to a hard drive, check the box for **Fixed HDD**. Select the correct hard drive from the **Select Backup Media** box, then press the button.

If the amount of video exceeds the storage capacity of the media being used then an error message will be displayed inside the error message box. If this happens, reduce the amount of video that is being exported or select another media device that has a larger storage capacity.

Once the button is pressed, the **Backup Options** window will close.

The status of the recording process can be monitored by viewing the **Backup Progress** bar. This can be seen on the Main Display screen.

The Backup will be completed successfully when the Backup Progress Bar disappears from the Main Display Screen.

8.9 REMOVING THE DISC FROM THE CD-RW DRIVE

6. Press the **Open** button on the CD-RW drive. The Eject CD Window should appear on the screen.

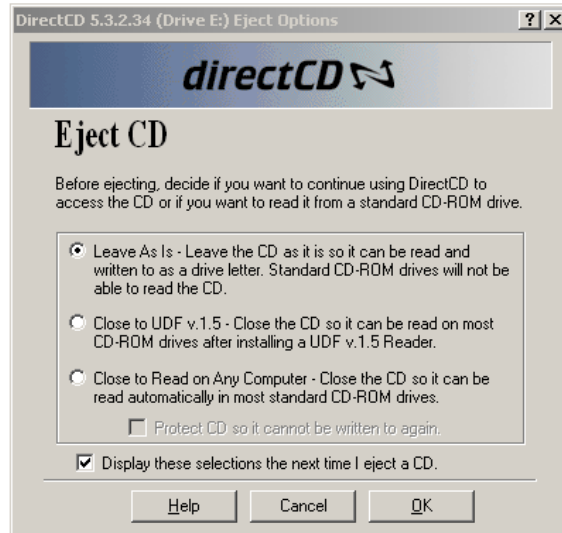

7. Select the **Leave As Is** option to continue using the CD for future backups by the DVR unit. The disk may not be able to read in other CD-ROM drives if this is selected.

Select the **Close To UDF v 1.5** to view the data in standard CD-ROM Drives. The host computer that will be viewing the data must have Roxio UDF Reader installed to view the data. When this option is selected, a copy of the UDF reader is automatically placed onto the CD so that if the host computer does not have the UDF reader installed, it can be installed from the same CD that has the data.

RECOMMENDED: Select **CLOSE TO READ ON ANY COMPUTER**. This option allows the CD to be playable on most PC's. In order to read this CD, the CD-ROM must support Multi-Read.

8. Click **OK** to eject the CD. Select **Cancel** to exit the Eject CD dialog box without ejecting the CD.
9. Once the CD-RW drive door opens, remove the CD and place it in a protective sleeve or case.

NOTES:

SECTION 9

LAN / ISDN / PSTN CONNECTIONS

9.1 LAN OVERVIEW

The DVR unit can easily be connected to a Local Area Network (LAN) and uses Microsoft's® powerful and secure Windows® 2000 operating system. This allows for easy and well-documented instructions on setting up LAN connections no matter what type of LAN you want to use.

A LAN is a group of computers and other devices dispersed over a relatively limited area and connected by a communications link that allows one device to interact with any other on the network. Local Area Network is also called LAN.

Examples of LAN connections include Ethernet, Token Ring, cable modems, DSL, FDDI, IP over ATM, IrDA (Infrared), wireless, and ATM-emulated LANs. Emulated LANs are based on virtual adapter drivers such as the LAN Emulation Protocol.

There are a vast amount of reasons why using Microsoft® Windows® 2000 is far superior to other platforms when running on a LAN. The number one reason is security. Windows 2000 is based on NT technology, which, historically has boasted the most reliable and secure Operating System in the world. Running the DVR on a secure network is important to prevent unwanted users from gaining access to confidential information. Unwanted users can compromise the integrity of the confidential data being stored and viewed, and in extreme circumstances can cause irreparable damage to the network.

Since connecting the DVR unit to a network can be extremely complex (depending on the network), this Fusion DVR manual will cover only the basics. It is suggested that you consult your Vendor or IT Administrator before attempting to create or connect to a LAN.

9.2 CONNECTING TO A LAN USING TCP/IP

The networking options of the DVR unit can create and edit all Network settings available on Windows 2000. The DVR unit comes equipped with a 10/100 Network Interface Card (NIC). This card uses a standard RJ-45 connector.

The DVR unit comes preconfigured with an IP Address of [172.25.2.1] and a subnet mask of [255.255.0.0]. These IP settings will work for many users. If these IP settings are sufficient then re-configuring TCP/IP will not be necessary.

9.2.1 CONFIGURING TCP/IP SETTINGS

1. Exit and restart in Windows mode.
2. Right-click on the **My Network Places** icon located on the desktop and select **Properties**. The Network and Dial-Up Connections window opens.
3. Right-click **Local Area Connections** and select **Properties**. The Local Area Connection Properties window opens.

4. Select the **Internet Protocol (TCP/IP)** by clicking on it once. Once it is highlighted, select the **Properties** button. The Internet Protocol (TCP/IP) Properties window opens.
5. Select **Use the Following IP Address** option. Enter the IP Address and Subnet mask appropriate for your network. It is recommended to contact your Network Administrator for appropriate IP settings.

Example: Common IP addresses are 10.0.0.25
Common Subnet masks are 255.255.255.0

NOTE: In order to connect to the DVR unit through a remote LAN connection, a static IP address must be assigned. If the network assigns the IP address automatically (DHCP), contact the Network Administrator for help assigning a static IP address.

6. If the network requires specifying your DNS information, enter it now by selecting the appropriate DNS options.
7. When finished configuring the TCP/IP settings close the **Internet Protocol (TCP/IP) Properties** window by clicking the **OK** button.¹
8. Close the **Local Area Connection Properties** window by clicking the **OK** button.
9. It may be required to restart Windows for the changes to take effect. Restart windows by selecting START on the desktop and selecting Restart.

9.2.2 CONNECTING THE DVR TO A LAN

Using a standard RJ-45 cable, plug one end into a Hub (or Network Jack ultimately connected to a hub) and the other end into the DVR unit.

SECTION 10

Digital Signature Verifier

10.1 DIGITAL VERIFIER

JPG images and AVI video files that are exported from the Digital Video Recorder are automatically embedded with a Digital Signature. Digital Signatures are a way to verify the authenticity of the images to ensure that they have not been tampered with or edited in any way. Included on the Software Installation CD supplied with the DVR unit is the Digital Signature verification program. This program can be installed on any computer and simply loads an image in question

10.2 INSTALLING THE DIGITAL VERIFIER

1. Insert the Software Installation CD into the CD-ROM.
(Do not install on the DVR unit.)
2. Select the Digital Verifier option to begin installation.
When the **Welcome** screen appears, select **Next**.

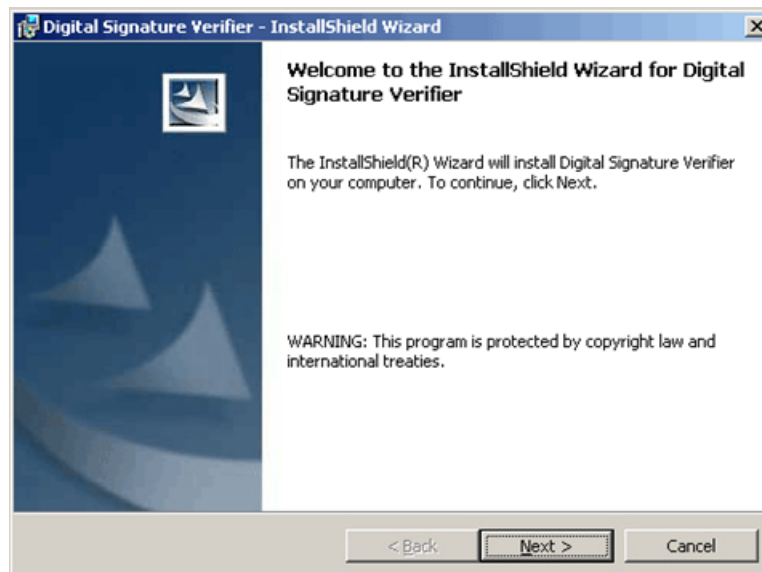

10.2 INSTALLATION, CONTINUED

3. When the **Setup Complete** window appears select **Finish**. Setup is now complete.

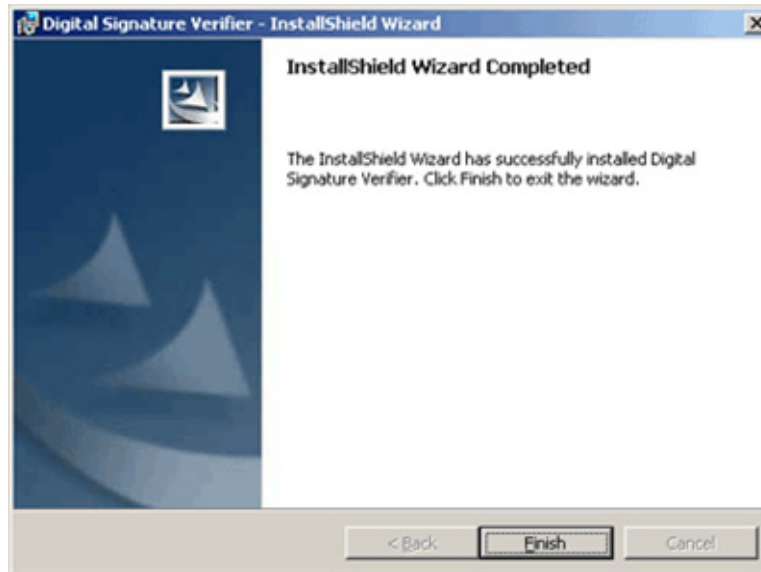

10.3 USING THE Digital Verifier

1. Open the Digital Signature verification program by selecting **Start → Programs → FUSION → Digital Signature Verifier → Digital Signature Verifier**.



10.3 USING THE DIGITAL VERIFIER, CONTINUED

2. Select the **Browse** button to load the JPG or AVI file.
3. Enter the **Site Code** of the DVR unit that the image was originally extracted from.
4. Click the **Verify** button to continue or **Close** to close the window without verifying.

If the image has not been tampered with, the program will display a message that says “**Original image file.**”

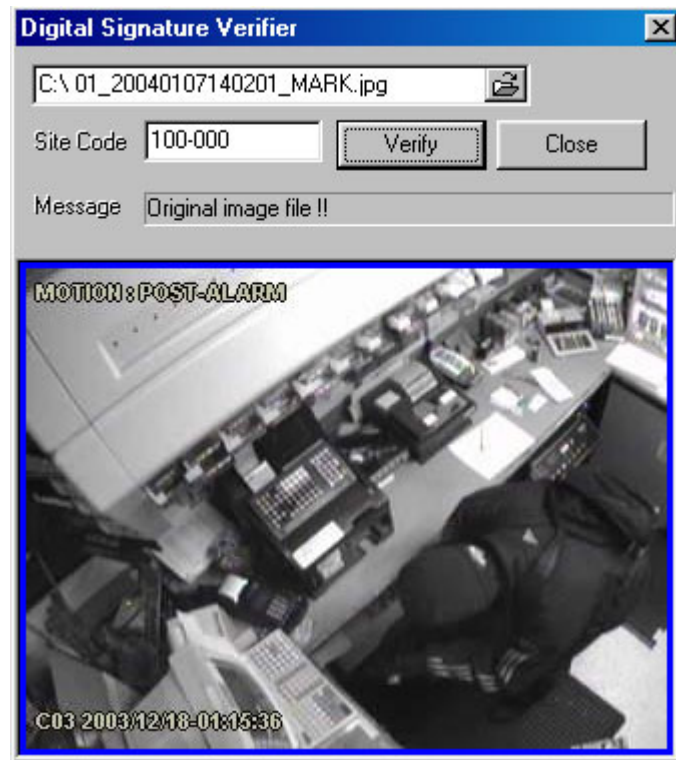

If the image has been tampered with, then a red square will be drawn around the image and a message will appear saying “**Entire image changed or wrong SITE CODE.**”

10.3 USING THE DIGITAL VERIFIER, CONTINUED

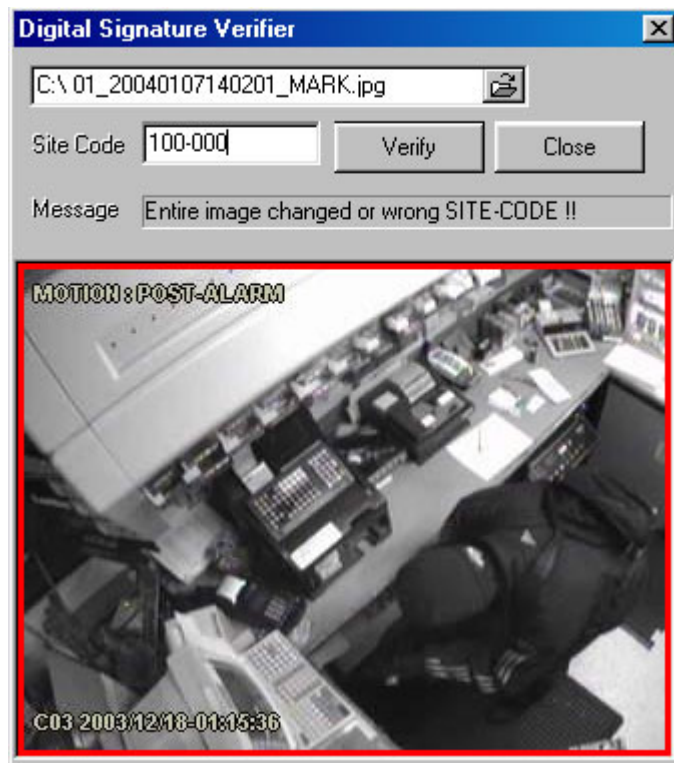

SECTION 11 PROPRIETARY VIEWER

11.1 PROPRIETARY VIEWER OVERVIEW

The Proprietary Viewer plays back the exported video in its proprietary format. Video saved in this format is extremely difficult to tamper with and therefore is the ideal solution when law enforcement and legal departments are involved. This video cannot be read by any other viewer.

The Proprietary Viewer is essentially the Search portion of the DVR software. For detailed explanation of these functions, refer to Section 6.

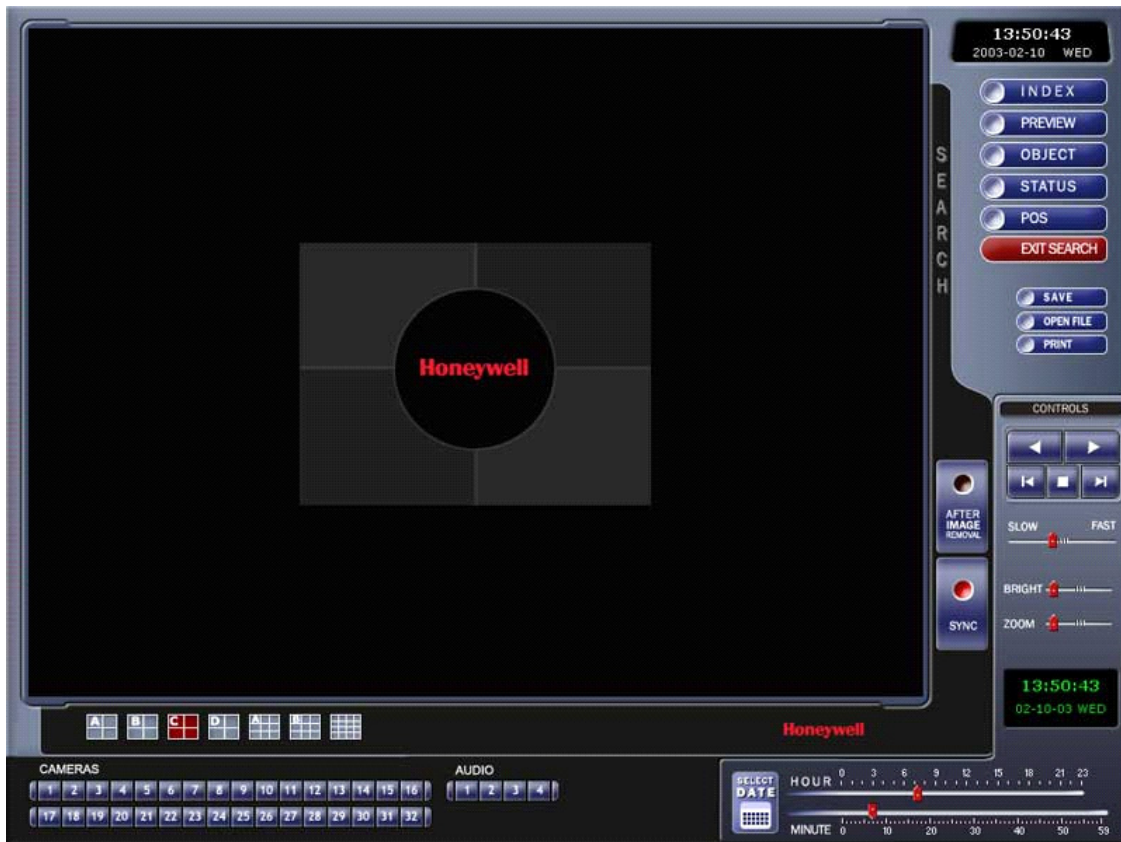

11.2 INSTALLING THE PROPRIETARY VIEWER

1. Insert the Software Installation CD into the CD-ROM.
(Do not install on the DVR unit.)
2. Select the Proprietary Viewer option to begin installation.
When the **Welcome** screen appears, select **Next**.

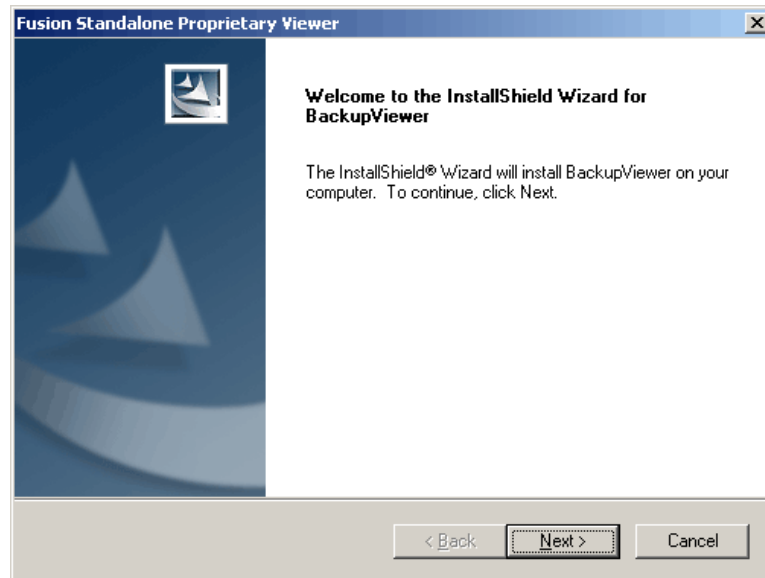

3. When the **Choose Destination Location** window appears select **Next**.
This will install the Proprietary Viewer in the default destination folder.

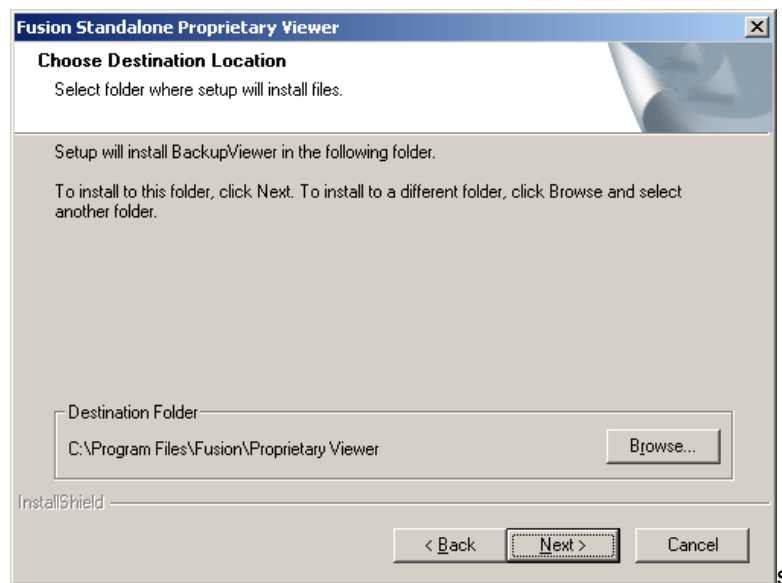

11.2 INSTALLING THE PROPRIETARY VIEWER, CONTINUED

4. When the **Select Program Folder** window appears select **Next**.

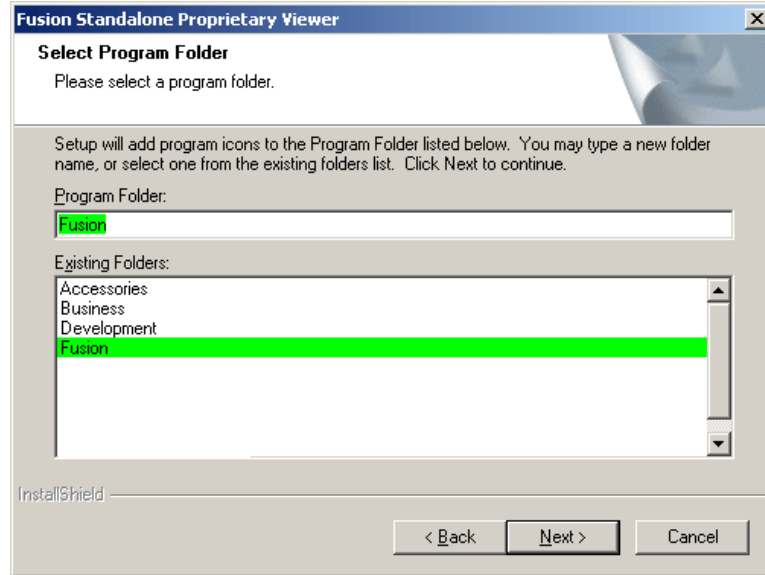

5. Select either 16 or 32 channel option depending on the Model you have. You can always reinstall and change this option at a later date. Press **Next**.

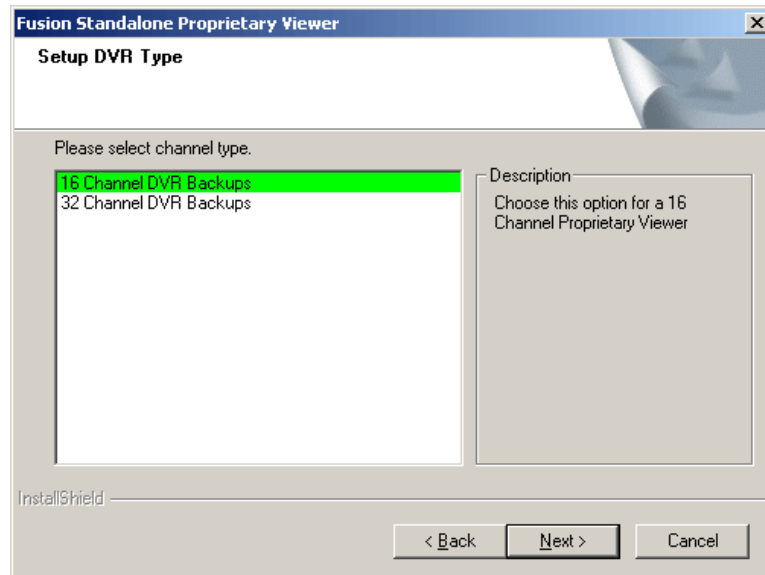

11.2 INSTALLING THE PROPRIETARY VIEWER, CONTINUED

If you have purchased the TVS POS Remote option from TVS then select the **YES**

option. Otherwise select the **NO** option. Press **Next**.

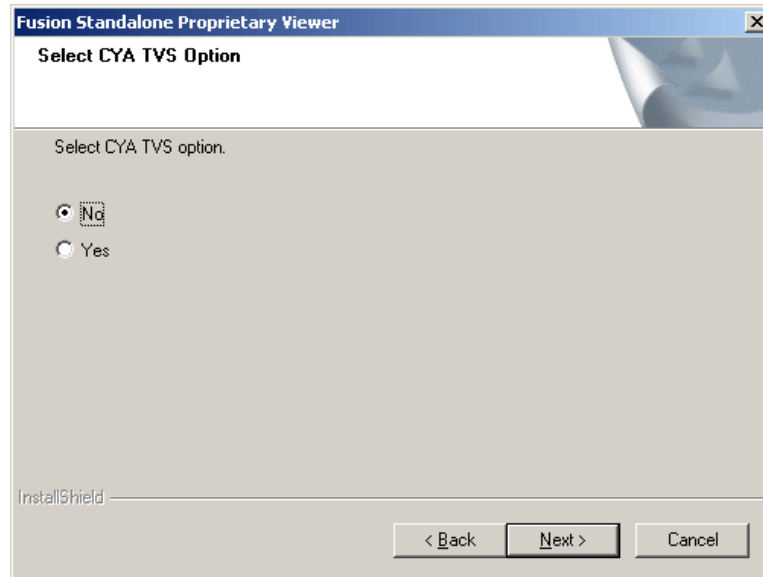

6. When this window appears select **Finish**. Setup is now complete.

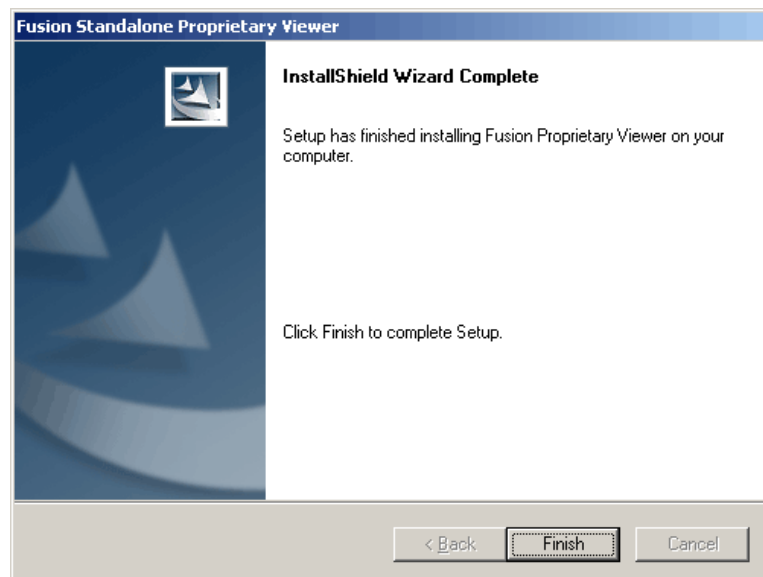

11.3 LOADING VIDEO FROM CD-ROM OR HARD DRIVE

1. Open the Proprietary Viewer program by selecting **Start → Programs → DVR → Proprietary Viewer → Proprietary Viewer**.
2. Select **Backup Search** (see Section 6.7 – Performing a Basic Search) and the **Choose time to Search** window opens.

3. For CD-ROM data, select the appropriate CD-ROM drive letter from the **Backup Media** box.

For hard drive data, select either an attached hard drive from the **Backup Media** box or select the **Open Folder** icon which allows you to browse to the specified directory.

Once selected, any available video data will be displayed in the **Choose Start Hour** box.

4. Click on the desired time to select it.
5. Press **OK**.

The video will now load into the Proprietary Viewer. To view the video, follow the instructions for searching as described in Section 6.

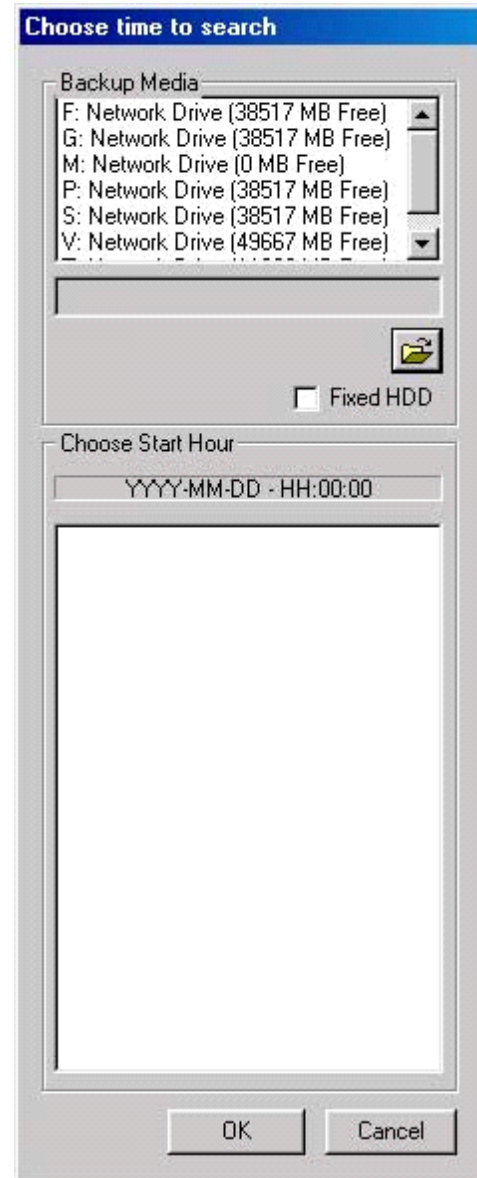

NOTES:

SECTION 12 ALARM MONITOR

12.1 ALARM MONITOR OVERVIEW

The Alarm Monitor software is a utility that streams video across a Local Area Network to a Client PC when an alarm is detected on the DVR unit. The video that streams across can be stopped, played forwards and backwards, in slow motion or real speed.

The utility is loaded at startup and placed in the taskbar. It constantly monitors for a signal from the DVR unit. When an alarm signal is detected the Alarm Monitor Image Viewer window opens and starts playing the video from the camera associated to the alarm.

12.2 INSTALLING THE ALARM MONITOR

- 1 Insert the Software Installation Disc into the CDROM. (Do not install on the DVR unit) Select the Alarm Monitor option to begin installation and accept the license agreement.

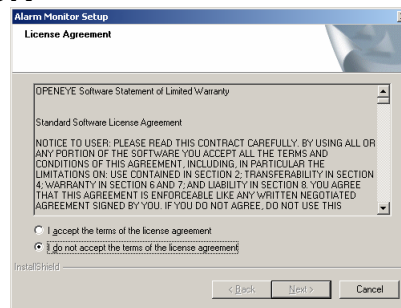

- 2 When the WELCOME screen appears, click NEXT.

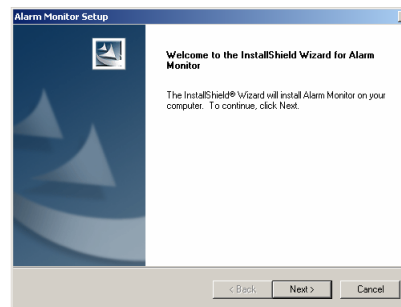

- 3 When the CHOOSE DESTINATION LOCATION window appears click NEXT.

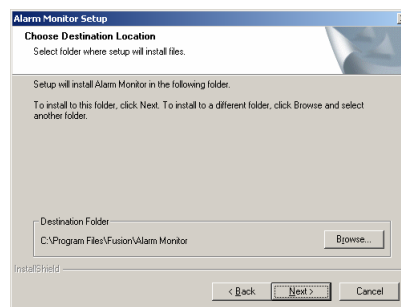

12.2 INSTALLING THE ALARM MONITOR, CONTINUED

- 4 When the SETUP COMPLETE window appears click FINISH.

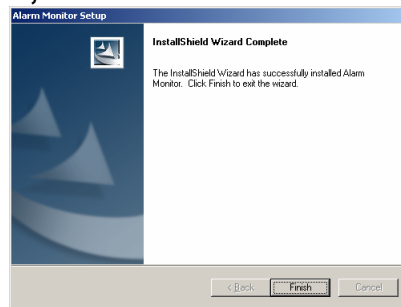

12.3 CONFIGURING THE DVR

To enable the Alarm Monitor on the DVR follow these steps:

1. Enter SETUP and click the **Recording Schedule** tab.
2. Assign the desired sensors to the desired cameras. Refer to the Recording Schedule section of this manual for in depth instructions on how to do this.
3. Enable Sensor Event and/or Motion Event in the Alarm Options Section of each schedule number you wish to send alarm events to the Alarm Monitor.

NOTE: The Remote Alarm and Emergency Alarm options are used by the more advanced FVMS multi site management and control software.

4. Enter the IP Address of the computer running the Alarm Monitor software.
5. Click the **Network** tab and make sure that Disable Remote Control is not checked.
6. The Alarm Monitor uses the Emergency Port to transfer the data through. The port can be adjusted inside the Network Menu if necessary. It is recommended that unless the port must be changed, that the default setting should be used.
7. Click the **Sensor** menu tab.
8. Configure the Sensors you have assigned to cameras.
9. Click OK.

12.4 CONFIGURING THE CLIENT PC

All configuration takes place in the Alarm Monitor Window on the Client PC for descriptions and locations of the buttons and features of the Alarm Monitor window Refer to the Alarm Monitor Window section later in this chapter.

- 1 Open the Alarm Monitor window on the Client PC.
Start >Programs > Fusion > Alarm Monitor > Alarm Monitor

- 2 Click New in the DVR List and enter the site code, site name, and IP Address of the DVR you wish to connect to in the Site Edit window that opens. Click Save

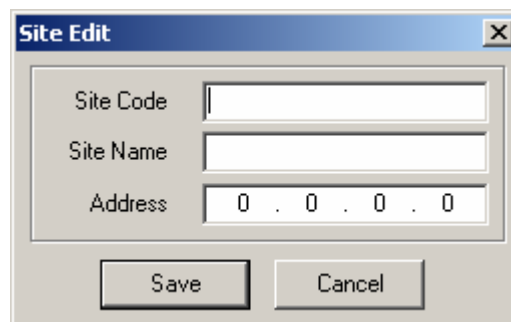

The image shows a 'Site Edit' dialog box with a blue title bar and a close button (X) in the top right corner. It contains three input fields: 'Site Code' (empty), 'Site Name' (empty), and 'Address' (pre-filled with '0 . 0 . 0 . 0'). At the bottom, there are two buttons: 'Save' and 'Cancel'.

Note: The site code can be found under the information tab in the setup menu.

- 3 Click the Tools menu and select Setup.
- 4 Confirm that the Listen Port in the **Configuration Window** is set to the same number as the Emergency Port in **Communication Settings** on the DVR. If the numbers are different adjust the Listen Port on the client PC to match the DVR.
- 5 Click Enter
- 6 Reboot the Client PC

12.5 ALARM MONITOR WINDOW

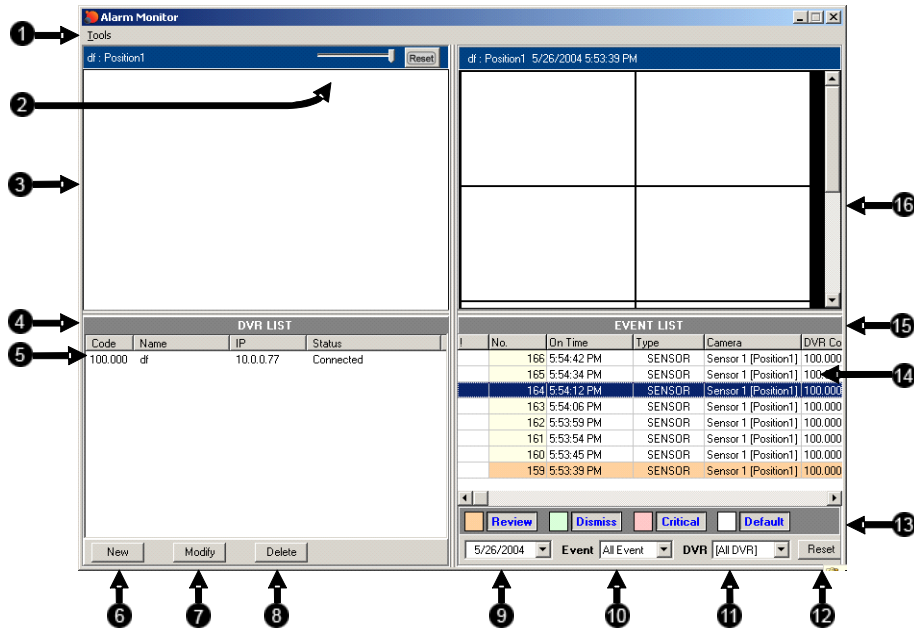

1	Tools Menu	Opens the Setup (Configuration) window and Opens or Closes the Event List.
2	Zoom	Zoom in or out of the displayed video or reset to default.
3	Video Display	Displays the Video feed coming from the DVR.
4	DVR List	Lists all DVR units you have connected to the Alarm Monitor.
5	DVR List Item	Individual DVR unit in DVR List with displayed settings.
6	New	Opens Site Edit window to connect new DVR to Alarm Monitor.
7	Modify	Opens Site Edit to allow modification of selected DVR List Item.
8	Delete	Deletes selected DVR List Item.
9	Date	Selects date of events to display in the Event List.
10	Event	Selects type of Event to Display in the Event List.
11	DVR	Selects DVR to display in the Event List.
12	Reset	Resets Date, Event, and DVR fields to defaults.

12.5 ALARM MONITOR WINDOW, CONTINUED

13	Event Filter	Filters Events based on the Alarm Status assigned to them. Click a filter to show or hide the associated events. Right click an event to assign it an Alarm Status.
14	Event List Item	Individual Event in Event List. Double-Clicking on an event opens the associated video in the Search Alarm window.
15	Event List	Lists all recorded events matching the Date, Event, and DVR settings.
16	Event Preview	Displays a preview image of all recorded events matching the Date, Event, DVR, and Filter settings.

12.5.1 EVENT LIST RIGHT CLICK

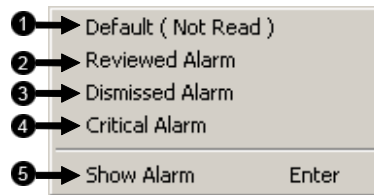

1	Default	Sets an alarm event to Default.
2	Reviewed Alarm	Sets an alarm event to Reviewed.
3	Dismissed Alarm	Sets an alarm event to Dismissed.
4	Critical Alarm	Sets an alarm event to Critical.
5	Show Alarm	Opens event in the Search Alarm Window.

12.6 SEARCH ALARM WINDOW

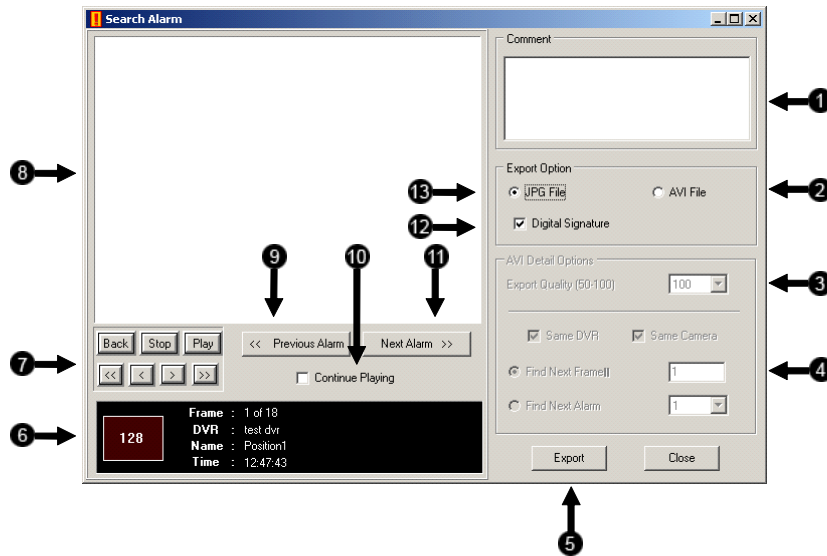

1	Comment	Provides space for user to add comments to video events.
2	AVI File	When selected a video clip exported when Export is clicked.
3	Export Quality	It may be necessary to reduce the overall size of an AVI file; for example, to email to someone. AVI file sizes can be reduced by reducing the image quality. However, reducing the image quality causes the AVI video to appear more pixelated. When size is not an issue, setting quality to 100 is highly recommended.
4	Export Options	These options are only available when AVI export is selected and relate to the export options of the AVI video.
5	Export	Exports AVI or JPG file to selected location.
6	Alarm Event Information Display	Displays the event number and pertinent recorded information related to the alarm event.
7	Playback Controls	The play controls allow you to play the video forward, backwards, and frame by frame.
8	Display	Displays video playback.
9	Previous Alarm	Moves to previous Alarm Event.
10	Continuous Playing	Plays through all alarm events when video playback is initiated. When not selected video playback stops at end of recorded event.
11	Next Alarm	Moves to next Alarm Event.

12.6 SEARCH ALARM WINDOW, CONTINUED

12	Digital Signature	Adds a digital signature to the exported JPG image for use with the Digital Signature Verifier to verify integrity of exported images and prevent tampering.
13	JPG File	When selected a JPG image is exported when Export is clicked.

12.7 CONFIGURATION WINDOW

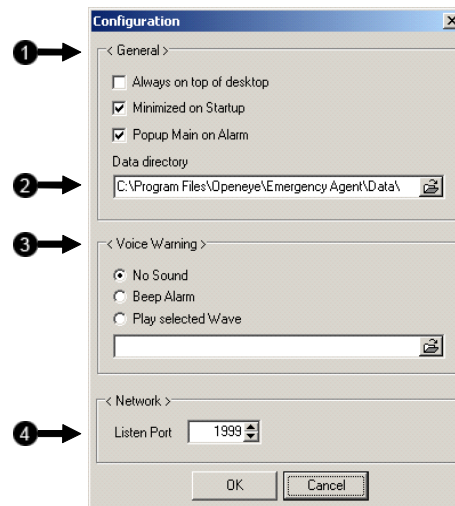

1	General	Offers configuration of basic display options for the Alarm Monitor window.
2	Data Directory	Sets the location that recorded video footage is saved.
3	Voice Warning	Offers several configuration settings for activating an audible indicator when the Alarm Monitor receives an event.
4	Listen Port	Indicates the port which the Alarm Monitor uses to listen for incoming events. This number should be changed to the same number as is set in the Emergency Port in Communication Settings on the DVR.

NOTES:

SECTION 13 REMOTE SOFTWARE

13.1 FUSION REMOTE SOFTWARE OVERVIEW

The DVR unit was specifically designed to be fully operated and maintained remotely. It connects using the standard TCP/IP protocol through connection types such as DSL, Cable Modem, T1, ISDN, 56K Modem, LAN, and more. The Fusion Remote software provides for viewing live video, searching through archived video, exporting images and video clips; and provides virtually full Setup control.

Highlights:

- Search archived video
- View live video
- Export images and video clips
- Control relay outputs
- Setup administration

Basics:

The DVR can have up to 5 Simultaneous remote Connections. Each user can perform functions on the DVR unit and will not affect the other users. The only exception to this is accessing Setup. Only one user is allowed to access setup at any given time. The Frames per Second passed to the Remote Client varies greatly depending on the connection type and speed.

In order to log in to the DVR server, a user account must be made for the user. This ensures that only authorized personnel are allowed to log in. In addition, each user can be assigned different privileges that allow them or deny them access to different functions. (See Section 5.9 – User Management.) For example, a user can be denied Searching and Setup privileges and only granted access to view cameras 4, 8 and 16.



It is highly recommended that users not be granted Setup privileges since this can pose a security risk. Only properly authorized Administrators should have access to Setup.

The Remote software operates virtually the same way as the DVR itself. Its appearance matches the DVR almost identically, however, there are a few minor differences. Some search features are not available (such as the Index and Object Searches) as well as some Setup options.

13.1 FUSION REMOTE SOFTWARE OVERVIEW, CONTINUED

13.1.1 REMOTE CLIENT MINIMUM REQUIREMENTS

- Pentium 233 or equivalent
- 32MB System Memory
- DirectX 8 or higher
- Compatible video card (ATI Preferable)
- Internet or LAN Connection (56K, DSL, Cable Modem, T1, ISDN, etc.)
- TCP/IP installed
- Microsoft® Windows® 98, Me, 2000, or XP Operating System
- 1024 x 768 display resolution
- 16 Bit color depth or better

13.1.2 REMOTE CLIENT RECOMMENDED REQUIREMENTS

- Pentium IV 1.5+ or equivalent
- 256MB System Memory
- DirectX 8 or higher
- Compatible video card (ATI Preferable)
- Internet or LAN Connection (DSL, Cable Modem, T1, ISDN, etc.)
- TCP/IP installed
- Microsoft® Windows® 2000 or XP Operating System
- 1024 x 768 display resolution
- 32 Bit color depth or better

13.2 SETTING UP THE SERVER TO ACCEPT INCOMING CONNECTIONS

In order to access the DVR unit remotely, the DVR Server must be setup to allow remote connections.

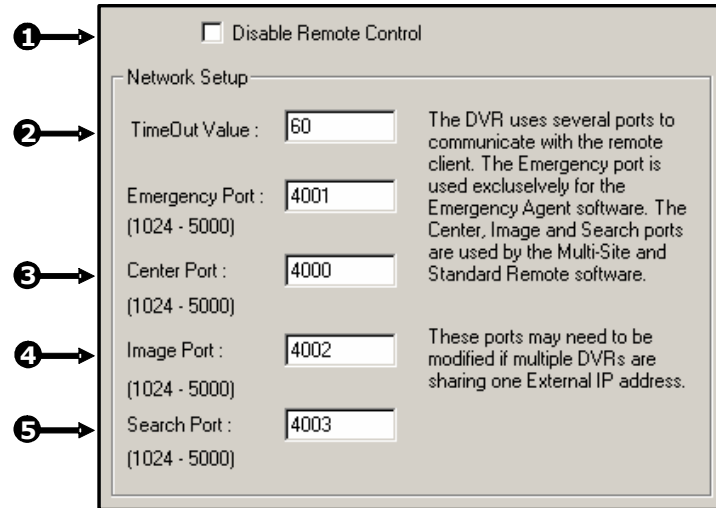

1	Disable Remote Control	Enables/Disables acceptance of remote connections by the DVR server.
2	Time Out Value	Specifies a value (in seconds) to wait for a signal from the Fusion Remote Client. If a signal is not received by that time, the connection is dropped.
3	Center Port	Used by the DVR to transfer the connection data.
4	Image Port	Used by the DVR to transfer the image data.
5	Search Port	Used by the DVR to transfer the search data

13.2.1 CONFIGURING THE DVR SERVER TO ACCEPT REMOTE CONNECTIONS

1. Enter **Setup** on the DVR unit.
2. Open the **Network** menu.
3. Uncheck the **Disable Remote Control** option.
You should now be allowed to adjust port settings if necessary.

NOTE: If a Firewall is being used, it may be necessary to adjust the port settings on both the DVR and the Firewall. Contact the Network Administrator for more information.

4. Press **OK**.
5. Make sure a **User** account is created.
Without a user account, the **Administrator** account must be used.

The DVR server is now ready to receive incoming connections.

13.3 SETTING UP THE FUSION REMOTE SOFTWARE

13.3.1 INSTALLING THE FUSION REMOTE SOFTWARE

1. On the Client computer, insert the Honeywell Fusion Software CD into the CD-ROM. The CD should play automatically.
2. When prompted, select the Install Fusion Remote Software option. Follow the installation instructions carefully.
3. When the software finishes installing, close any open installation windows.

13.3.2 CREATING A NEW REMOTE CONNECTION

1. Select **Start → Programs → DVR → Center → DVR Center**. The Honeywell Fusion Center Software opens and a Site Connection List window opens.

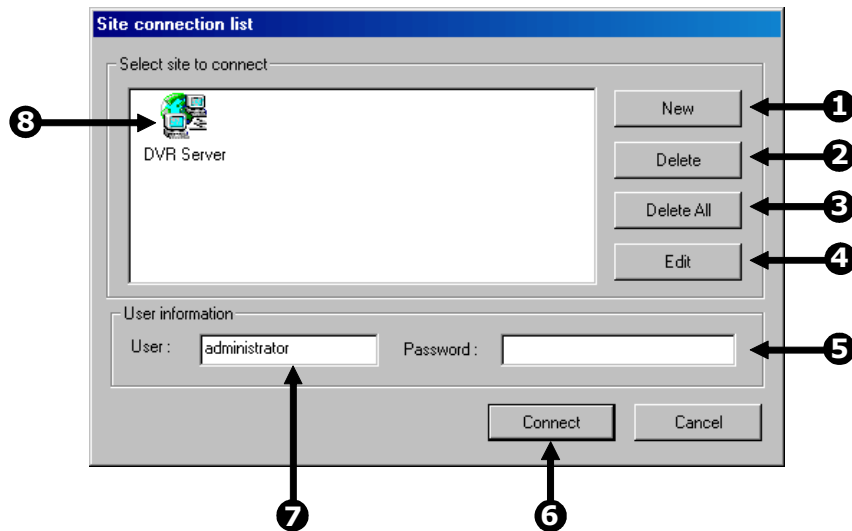

1	New	Creates a new site to connect to.
2	Delete	Deletes the selected site once it is selected from the list.
3	Delete All	Deletes all listed sites.
4	Edit	Used to edit a site once it is selected from the list.
5	Password	Enter the logon password.
6	Connect	Connects the Fusion Remote Client to the Server.
7	User	Enter the Login Username.
8	Site	Displays a list of pre-configured sites.

13.3 SETTING UP THE FUSION REMOTE SOFTWARE, CONTINUED

2. Press **New** to open the **Site Detail Information** window.
3. Enter the **Site Code** and **Site Name**. The **Site Code** will be the name displayed inside the connection box to help identify the unit.
4. Enter the **IP Address** of the DVR server.
By default the DVR unit is set to connect using DHCP.
5. Enter the **Center Port**. This setting is specified on the server (See Section 13.2.)
6. Press **OK**.
7. Click on the newly created connection and enter the login username and password.
8. Press **Connect**.

NOTES:

SECTION 14 THE WEB VIEWER

14.1 WEB VIEWER OVERVIEW

The DVR unit allows access to the video using Microsoft® Internet Explorer® Browser 5.5 and later

Highlights:

- View Live Video from most computers
- Username and Password protected
- Easy to use graphical interface

Basics:

75 users can access the Web DVR simultaneously. The Web DVR is an easy secure way to view live video from virtually any computer with an internet connection using Microsoft Internet Explorer.

In order to log in to the DVR server, a user account must be made for the user. This ensures that only authorized users are allowed to log in. In addition, each user can be assigned different privileges that allow them or deny them access to different functions. (See Section 5.9 – User Management.) For example, a user can be granted access to only view cameras 4, 8 and 16.

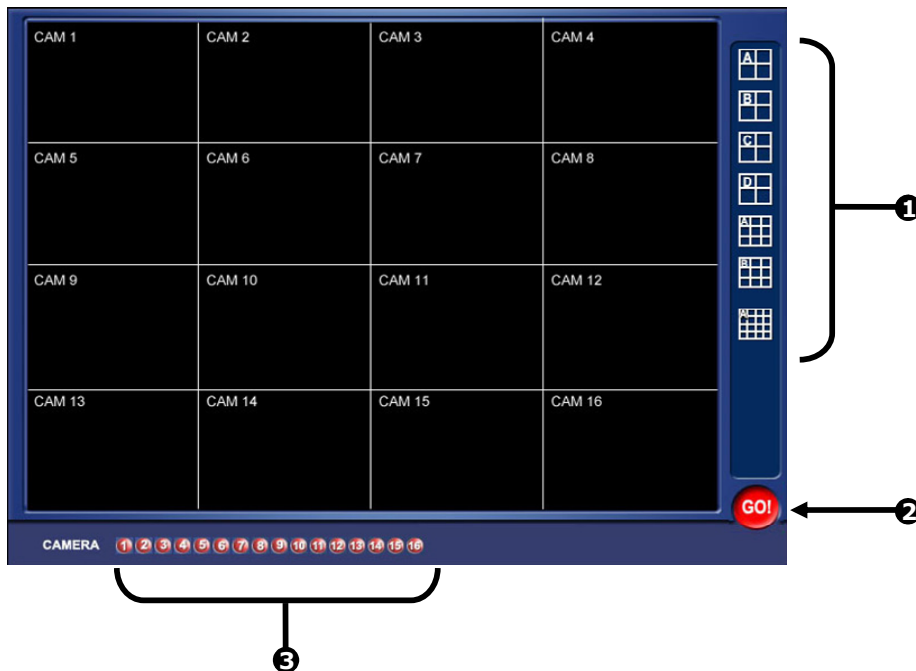

14.1 WEB VIEWER OVERVIEW, CONTINUED

1	Screen Division Buttons	Allows view of one or more sets of cameras at a time. They are organized in several different groups such as 1x1, 4x4, and 8x8.
2	GO!	Activates the commands
3	Camera Buttons	Enable or disable selected cameras for use when searching.

14.1.1 CONFIGURING THE DVR SERVER TO ACCEPT REMOTE CONNECTIONS

1. Enter **Setup** on the DVR unit.
2. Open the **Network menu**.
3. Uncheck the **Disable Remote Control** option.
Adjust port settings if necessary.

NOTE: If using a Firewall, it may be necessary to adjust the port settings on both the DVR and the Firewall. Contact the Network Administrator for more information.

4. Check the **Enable Web Viewer** option.
Again, adjust port settings if necessary
5. Press **OK**.
6. Make sure a **User** account is created.
Without a user account, the **Administrator** account must be used.

The DVR server is now ready to receive incoming connections.

14.1.2 CONNECTING TO A DVR WITH THE WEB VIEWER

1. Open Microsoft® Internet Explorer® 5.5 or later.
2. Enter the IP address of the DVR into the **Address Bar**.
3. When attempting this for the first time a window will open and ask for approval to accept an Active X installation. Select **Yes** to this.

NOTE: If a message is received saying your Internet Explorer® security settings do not allow for downloading Active X components then adjust the browser security settings. One way to do this is to add the IP address of the DVR to your trusted sites list inside Internet Explorer® settings. Contact the System administrator for additional help with adjusting Internet Explorer® settings.

4. When the Web Viewer finishes loading select one or more cameras (or select a screen division button).
5. Press **GO!**.

14.1 WEB VIEWER OVERVIEW, CONTINUED

6. A login window will appear. Enter a **Username** and **Password** that is authorized to access the DVR.
7. The cameras will now be displayed.

14.1.3 CLOSING THE WEB VIEWER

1. To exit the Web Viewer simply close Internet Explorer®.

NOTES:

SECTION 15 TECHNICAL SPECIFICATIONS

15.1 HFDVR FUSION 8-CHANNEL

	NTSC	PAL
CPU	Intel® Pentium® 4 2.0+ GHz	
Storage (Hard Drive)	120 GB Standard / Virtually Unlimited Storage Potential	
Storage MAX	Up to 6HDD with CD-RW	
Operating System	Microsoft® Windows® 2000	
Viewing Rate	Max 480 FPS	Max 480 FPS
Recording Rate (240 IPS)	Max 240 FPS	Max 200 FPS
Recording Rate (480 IPS)	Max 480 FPS	Max 400 FPS
Digital Control Output	8	
Sensor Input	8	
Resolution	720x480 / 720x240 x 360x240	720x576 / 720x288 / 360x288
Image Compression	MJPEG	
Average File Size	360x240 – 3~5k	
	720x240 – 4~8k	
	720x480 – 7~12k	
Video Inputs	8 CH (BNC)	
Looping Outputs	8 (BNC) – Each can be terminated (75Ω)	
Composite Outputs	RCA	
Video Outputs	S-Video, SVGA,	
Max FPS Per Channel	30 FPS	
Motion Detection	Up to 5 Regions Per Channel / Adjustable Sensitivity	
Remote Operation	Full Remote Control through PSTN, ISDN, ADSL, LAN, and TCP/IP	
Remote Software	Compatible with Microsoft Windows 98, Me, 2000, XP	
PAN / TILT / ZOOM	Built-in RS-422/485 Interface	
Recording Mode	Continuous, Motion Detection, Sensor, Scheduled Recording	
Backup	3.5" Floppy, CD-RW (DVD Optional)	
Digital Signatures	Supports Digital Signatures	
Alarm Monitor	Transmitted through TCP/IP – Pop-up Window	

15.2 HFDVR FUSION 16-CHANNEL

	NTSC	PAL
CPU	Intel® Pentium® 4 2.0+ GHz	
Storage (Hard Drive)	120 GB Standard / Virtually Unlimited Storage Potential	
Storage MAX	Up to 6 HDD with CD-RW	
Operating System	Microsoft® Windows® 2000	
Viewing Rate	Max 480 FPS	Max 480 FPS
Recording Rate (240 IPS)	Max 240 FPS	Max 200 FPS
Recording Rate (480 IPS)	Max 480 FPS	Max 400 FPS
Digital Control Output	16	
Sensor Input	16	
Resolution	720x480 / 720x240 x 360x240	720x576 / 720x288 / 360x288
Image Compression	MJPEG	
Average File Size	360x240 – 3~5k	
	720x240 – 4~8k	
	720x480 – 7~12k	
Video Inputs	16 CH (BNC)	
Looping Outputs	16 (BNC) – Each can be terminated (75Ω)	
Composite Outputs	RCA	
Video Outputs	S-Video, SVGA	
Max FPS Per Channel	30 FPS	
Motion Detection	Up to 5 Regions Per Channel / Adjustable Sensitivity	
Remote Operation	Full Remote Control through PSTN, ISDN, ADSL, LAN, and TCP/IP	
Remote Software	Compatible with Microsoft Windows 98, Me, 2000, XP	
PAN / TILT / ZOOM	Built-in RS-422/485 Interface	
Recording Mode	Continuous, Motion Detection, Sensor, Scheduled Recording	
Backup	3.5" Floppy, CD-RW (DVD Optional)	
Digital Signatures	Supports Digital Signatures	
Alarm Monitor	Transmitted through TCP/IP – Pop-up Window	

15.3 HFDVR FUSION 32-CHANNEL

	NTSC	PAL
CPU	Intel® Pentium® 4 2.0+ GHz	
Storage (Hard Drive)	120 GB Standard / Virtually Unlimited Storage Potential	
Storage MAX	Up to 6 HDD with CD-RW	
Operating System	Microsoft® Windows® 2000	
Viewing Rate	Max 480 FPS	Max 480 FPS
Recording Rate (240 IPS)	Max 240 FPS	Max 200 FPS
Recording Rate (480 IPS)	Max 480 FPS	Max 400 FPS
Digital Control Output	16	
Sensor Input	16	
Resolution	720x480 / 720x240 x 360x240	720x576 / 720x288 / 360x288
Image Compression	MJPEG	
Average File Size	360x240 – 3~5k	
	720x240 – 4~8k	
	720x480 – 7~12k	
Video Inputs	32 CH (BNC)	
Composite Outputs	RCA	
Video Outputs	S-Video, SVGA	
Max FPS Per Channel	30 FPS	
Motion Detection	Up to 5 Regions Per Channel / Adjustable Sensitivity	
Remote Operation	Full Remote Control through PSTN, ISDN, ADSL, LAN, and TCP/IP	
Remote Software	Compatible with Microsoft Windows 98, Me, 2000, XP	
PAN / TILT / ZOOM	Built-in RS-422/485 Interface	
Recording Mode	Continuous, Motion Detection, Sensor, Scheduled Recording	
Backup	3.5" Floppy, CD-RW (DVD Optional)	
Digital Signatures	Supports Digital Signatures	
Alarm Monitor	Transmitted through TCP/IP – Pop-up Window	

Honeywell Video Systems

171 Eileen Way
Syosset, NY 11791, USA
www.honeywellvideo.com
TEL+1-516-921-6704
Toll-free TEL for North America: 1-800-796-CCTV

Honeywell Security Australia Pty Ltd.

Unit 5, Riverside Centre, 24-28 River Road West
Parramatta, NSW 2150, Australia
www.ademco.com.au
TEL +61-2-8837-9300

Honeywell Security Asia Pacific

Flat A, 16/F, CDW Building
388 Castle Peak Road
Tsuen Wan, N.T., Hong Kong
www.security.honeywell.com/hk
TEL +852-2405-2323

Honeywell Security France

Parc Gutenberg, 13, Voie La Cardon
91120, Palaiseau, France
www.ademco.fr
TEL +33-1-6932-1090

Honeywell Security Italia SpA

Via della Resistenza 53/59, 20090 Buccinasco
Milan, Italy
www.ademco.it
TEL +39-02-457-1791

Honeywell Security Espana

Calle Vivero, 5, 28040
Madrid, Spain
www.ademco.es
TEL +34-91-533-4706

Honeywell Security House (Netherlands)

Amperestraat 41
1446 TR Purmerend, Netherlands
www.SecurityHouse.nl
TEL +31-299-419-000

Honeywell Video Systems UK Ltd.

Aston Fields Road, Whitehouse Ind Est
Runcorn, Cheshire, WA7 3DL, UK
www.security.honeywell.com
TEL +44-1928-754-000

Honeywell Security South Africa

Unit 6 Galaxy Park, Galaxy Avenue,
Linbro Business Park
P.O. Box 59904, Kengray, 2100, South Africa
www.honeywell.co.za
TEL +27-11-574-2500

Honeywell Security Germany

Großenbaumer Weg 8
40472 Düsseldorf, Germany
www.ultrak.com
TEL +49-211-415-090

Honeywell Security Poland

Chmielewskiego 22a, 70-028
Szczecin, Polska
www.ultrak.pl
TEL +48-91-485-40-60

Honeywell Security Czech Republic

Havránkova 33, Brno
Dolní Heršpice, 619 00, Czech Republic
www.olympo.cz
TEL +420-543-558-111

Honeywell Security Slovakia Republic

Vajnorská 142, 83104 Bratislava
Slovakia
www.olympo.cz
TEL +421-2-444-54-660

Honeywell

© 2005 Honeywell International Inc.

All rights reserved. No part of this publication may be reproduced by any means without written permission from Honeywell Video Systems. The information in this publication is believed to be accurate in all respects. However, Honeywell Video Systems cannot assume responsibility for any consequences resulting from the use thereof. The information contained herein is subject to change without notice. Revisions or new editions to this publication may be issued to incorporate such changes.

ÊDRMU000834ÇŠ

DRMU000834-Rev. J - March 2005

Free Manuals Download Website

<http://myh66.com>

<http://usermanuals.us>

<http://www.somanuals.com>

<http://www.4manuals.cc>

<http://www.manual-lib.com>

<http://www.404manual.com>

<http://www.luxmanual.com>

<http://aubethermostatmanual.com>

Golf course search by state

<http://golfingnear.com>

Email search by domain

<http://emailbydomain.com>

Auto manuals search

<http://auto.somanuals.com>

TV manuals search

<http://tv.somanuals.com>