

# **HMLCD17e2, HMLCD19e2**

**e-Series LCD Monitor**

## **User Manual**

## Revisions

Issue	Date	Revisions
A	July 2007	Initial Release

---

## FCC COMPLIANCE STATEMENT

---

Information to the User: This equipment has been tested and found to comply with the limits for a Class B digital device, pursuant to part 15 of the FCC rules. This equipment generates, uses, and can radiate radio frequency energy and, if not installed and used in accordance with the instruction manual, may cause harmful interference to radio communications. This device complies with Part 15 of the FCC rules. Operation is subject to the following conditions:

- The device may not cause harmful interference.
- This device must accept any interference received, including interference that may cause undesired operation.

These limits are designed to provide reasonable protection against harmful interference in a residential installation. However, there is no guarantee that interference will not occur in a particular installation. If this equipment does cause harmful interference with radio or television reception, which can be determined by turning the equipment off and on, you are encouraged to try to correct the interference by one or more of the following measures:

- Reorient the receiving antenna.
- Relocate the system with respect to the receiver.
- Move the system away from the receiver.
- Plug the system into a different outlet so that the system and the receiver are on different branch circuits.

If necessary, consult a representative of Honeywell Inc. or an experienced radio/television technician for additional suggestions.

The following information is provided on the device or devices covered in this document in compliance with the FCC regulations:

- Product name:
- Model number:
- Company name:

**CAUTION:** Changes or modifications not expressly approved by the party responsible for compliance could void the user's authority to operate the equipment.

---

## IMPORTANT SAFETY INSTRUCTIONS

---

**READ INSTRUCTIONS** - All safety and operating instructions should be read before the unit is operated.

1. The safety and operating instructions should be retained for future reference.
2. Do not store or use the LCD monitor in locations that are exposed to heat, direct sunlight, or extreme cold.
3. Avoid moving the LCD monitor between locations with large temperature differences.
4. Do not subject the LCD monitor to severe vibration or high impact conditions. For example, do not place the LCD monitor inside a car trunk.
5. Keep flat panel monitor in room temperature conditions. Excessive cold or hot conditions can have an adverse effect on the liquid crystal of the display.

6. Never insert anything metallic into the monitor openings. Doing so may create the danger of electric shock.
7. To avoid electric shock, never touch the inside of the monitor. Only a qualified technician should open the monitor case.
8. Never use your monitor if the power cable has been damaged. Do not allow anything to rest on the power cable. Keep the power cable away from where people could trip over it.
9. Be sure to grasp the plug, not the cable, when disconnecting the monitor from an electric outlet.
10. Openings in the monitor cabinet are provided for ventilation. To prevent overheating, these openings should not be blocked or covered. Avoid using the monitor on a bed, sofa, rug, or other soft surface, as doing so may block the ventilation openings in the bottom of the cabinet. If you place the monitor in a bookcase or an enclosed space, be sure to provide adequate ventilation and air flow.
11. Place your monitor in a location with low humidity and minimum dust. Avoid places similar to a damp basement or dusty hallway.
12. Do not expose the monitor to rain or use it near water (in kitchens, next to swimming pools, etc.). If the monitor accidentally gets wet, unplug it and contact an authorized dealer immediately. You can clean the monitor with a damp cloth when necessary, being sure to unplug the monitor first.
13. Place the monitor on a solid surface and treat it carefully. The screen is made of glass and can be damaged if dropped or hit sharply.
14. Locate your monitor near an easily accessible electric outlet.
15. If your monitor does not operate normally - in particular, if there are any unusual sounds or smells coming from it - unplug it immediately and contact an authorized dealer or service center.
16. Do not attempt to remove the back cover while the monitor is plugged into an electric outlet, as you will be exposed to an electrical shock hazard. The back cover should only be removed by qualified service personnel.
17. Unplug the monitor when it is going to be left unused for an extended period of time.
18. Hg Lamp(s) inside this product contains mercury and must be recycled or disposed of according to local, state or federal laws. For more information, Go Or contact the electronic industries alliance: <http://www.eiae.org> for more information.

# Contents

Connecting the Monitor. . . . .	11
Mounting the Monitor . . . . .	14
Controls and Functions. . . . .	15
D-Sub Connector Pin Assignments . . . . .	20
Power Management . . . . .	21
Specifications and Parts . . . . .	22
Troubleshooting. . . . .	24



# Figures

Figure 1	Connecting to external devices . . . . .	11
Figure 2	Bottom panel controls . . . . .	11
Figure 3	Check input Signal. . . . .	12
Figure 4	Remote Control . . . . .	13
Figure 5	Back of the LCD monitor and mounting. . . . .	14
Figure 6	Front controls . . . . .	15
Figure 7	Input Source . . . . .	16
Figure 8	Screen settings . . . . .	16
Figure 9	Audio settings . . . . .	17
Figure 10	OSD (On Screen Display) settings . . . . .	17
Figure 11	Color settings . . . . .	18
Figure 12	Utility settings . . . . .	18
Figure 13	TV Utility settings. . . . .	19
Figure 14	D-Sub connector pins . . . . .	20

## Figures



## Tables

Table 1	D-SUB Pin Settings . . . . .	20
Table 2	Power Consumption . . . . .	21
Table 3	LED Indicator . . . . .	21
Table 4	Specifications list . . . . .	22
Table 5	Parts list . . . . .	22

## Tables

## Connecting the Monitor

The e-Series LCD monitor can be used with your video surveillance system and connects to a number of external devices, such as a DVR, VCR or camera.

**Figure 1 Connecting to external devices**

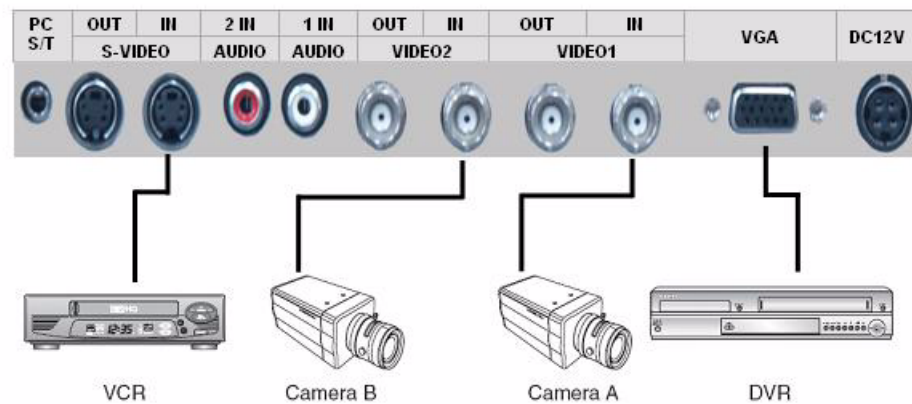

## Bottom Panel Controls

**Figure 2 Bottom panel controls**



1. PC STEREO IN
2. S-VIDEO (Y/C) OUT  
Y/C separated signal looping output
3. S-VIDEO (Y/C) IN  
Y/C separated signal input
4. AUDIO 2 IN  
Stereo Audio Signal Input
5. AUDIO 1 IN  
Stereo Audio Signal Input. This input is for AV1, S-Video.

## Connecting the Monitor

6. VIDEO 2(AV2) OUT  
Composite signal Output for AV2
7. VIDEO 2(AV2) IN  
Composite signal Input for AV2
8. VIDEO 1(AV1) OUT  
Video looping Output for AV1
9. VIDEO 1(AV1) IN  
Composite signal Input for AV1
10. D-SUB IN  
PC Signal Input
11. DC 12Volt IN

Note: If there is no connection than the following Check Input Signal message is displayed for 3 seconds:

**Figure 3 Check input Signal**

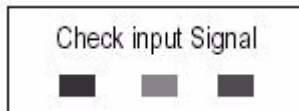

## Remote Controller

Figure 4 Remote Control

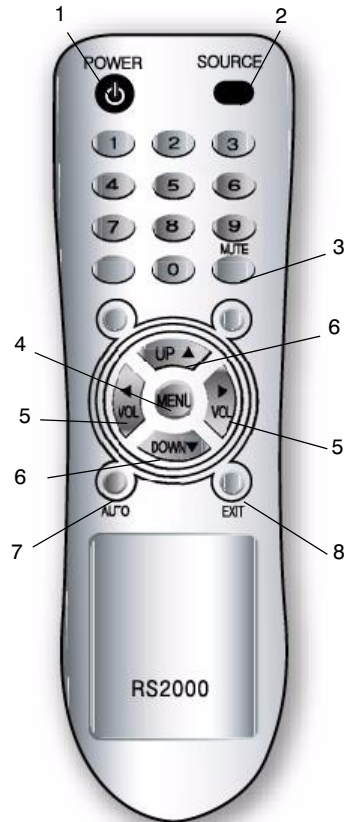

1. **POWER**  
Turns the power ON or OFF. There may be a few seconds delay before the display appears.
2. **SOURCE**  
Select PC or Video (PC/AV1/AV2/S-Video)
3. **MUTE**  
Mutes the sound.
4. **MENU**  
Activates and exits the On Screen Display (OSD).
5. **VOL**  
Move to OSD menu. Increases or decreases the level of audio volume. (Sound Option)
6. **UP/DOWN**  
Move to OSD menu. When down key is pressed on the main menu.
7. **AUTO**  
Auto geometry adjustment in the PC Source.
8. **EXIT**  
Exit the OSD.

## Mounting the Monitor

Figure 5 Back of the LCD monitor and mounting

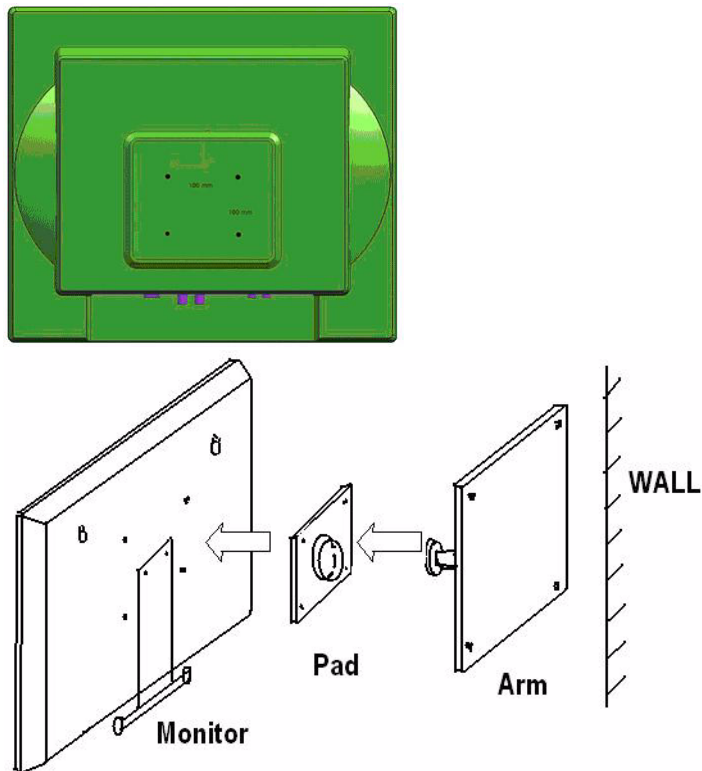

# Controls and Functions

## Front Panel Controls

The options available on the front of the LCD monitor mirror those of the remote control.

**Figure 6 Front controls**

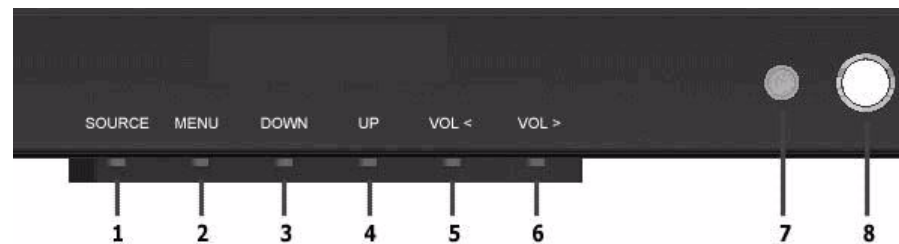

1. SOURCE  
Selects the input source and moves from the previous menu.
2. MENU  
Activates and exits the On Screen Display (OSD).  
It can also be used to move from the previous menu or status.  
OSD Menu(MAIN): Input Source, Screen, Audio, OSD, Color, Utility, Exit.
3. DOWN  
From the main menu, this button enables you to enter the sub-menu of the activated function.
4. UP  
Enter the sub-menu of the activated function.
5. VOL <  
Adjust menu settings and volume.
6. VOL >  
Adjust menu setting and volume.
7. IR Sensor  
Remote control sensor. Ensure that this sensor does not get obstructed.
8. POWER  
Turns the LCD monitor power on or off. The power LED (next to the power switch) is green when the power is turned ON and the LED turns Red when the power is turned off.

## OSD Menu

### Input Source:

Select PC, AV1, AV2 or SVIDEO



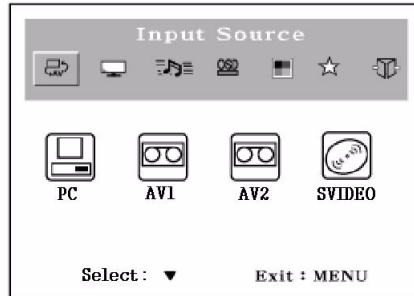

**Figure 7** Input Source

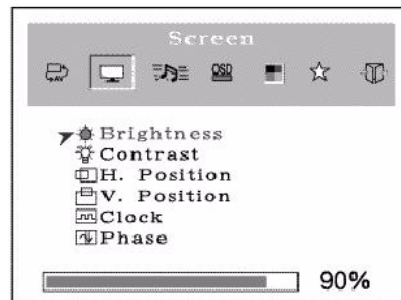

### Screen:

**Figure 8** Screen settings



-  **Brightness**  
Increase or decrease the intensity of the image.
-  **Contrast**  
Increase or decrease the intensity (lightness or dimness) of the image.
-  **H. position (PC Mode Only)**  
Move image horizontally on screen right or left.
-  **V. position (PC Mode Only)**  
Move image vertically on screen up or down.
-  **Clock (PC Mode Only)**  
Adjust the vertical noise of screen image.



-  Phase (PC Mode Only)  
Adjust the number of horizontal picture elements.

**Audio:** 

**Figure 9 Audio settings**

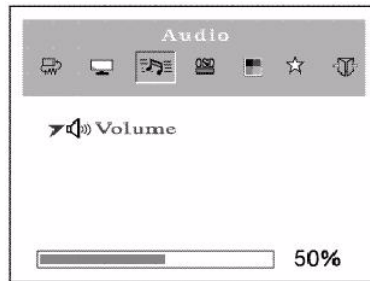



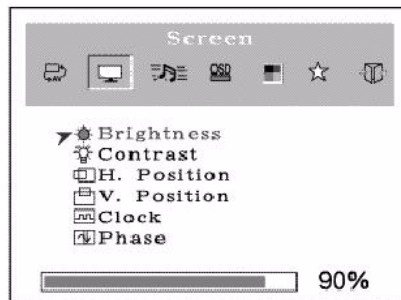

-  Volume  
Adjust audio volume.

**OSD:** 

**Figure 10 OSD (On Screen Display) settings**



-  H. Position  
Move the OSD position to right('▶') or left('◀').
-  V. Position  
Move the OSD position to up('▲') or down('▼').
-  Transparency  
Select the OSD background.
-  OSD Timer  
Select the OSD display timing.
-  Language  
Select a language among English, Français, Deutsch, Español, Danish, Italiano.

## Color (PC Mode):

Figure 11 Color settings

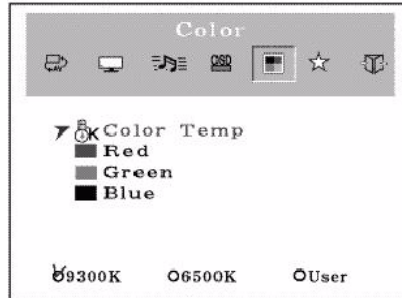



-  Color Temp  
Adjust color temperature to 9300, 6500, user. (note : 9300 is factory default)
- Red  
Adjust red color for user.
- Green  
Adjust green color for user.
- Blue  
Adjust blue color for user.

## Utility:

Figure 12 Utility settings



-  Recall  
Select to reset all setting to the factory default values.
-  Lock  
Select ON or OFF (ON : Control key lock. OFF : Control key unlock)
-  Exit  
Turn off OSD menu.

**TV Utility:** 

**Figure 13 TV Utility settings**

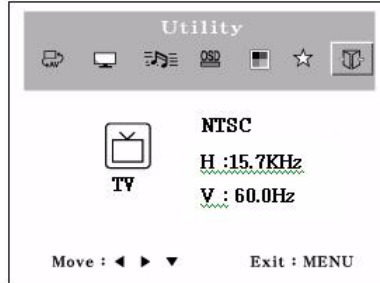

 Exit  
Turn off OSD menu.

## D-Sub Connector Pin Assignments

Figure 14 D-Sub connector pins

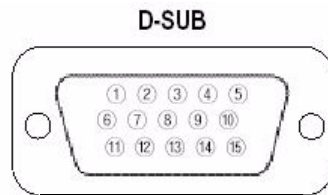

Table 1 D-SUB Pin Settings

Pin	Description
1	Red Video
2	Green Video
3	Blue Video
4	Ground
5	Ground
6	Red Ground
7	Green Ground
8	Blue Ground
9	
10	Signal Cable Detect
11	Ground
12	SDA (for DDC)
13	H-SYNC (or H+V SYNC)
14	V-SYNC
15	SCL (for DDC)

## Power Management

This LCD monitor features a power management system to power down upon receipt of a VESA DPMS (Display Power Management Signaling) from a VESA DPMS video card. This monitor enters an appropriate mode through identifying each of the three modes of the signaling system. The stage that the power management system is in is indicated by the LED on the monitor.

**Table 2 Power Consumption**

<b>Mode</b>	<b>Power Consumption</b>
ON	<50W
STANDBY	<5W
SUSPEND	<5W
ACTIVE OFF	<5W

**Table 3 LED Indicator**

<b>Mode</b>	<b>LED Color</b>	<b>Monitor Operation</b>
ON	Green	Normal operation.
STANDBY SUSPEND ACTIVE OFF	Amber	Screen blanks after preset idle time and some electronic circuits or all circuitry in the monitor shut down.
UNSUPPORTED MODE	Green	Normal operation, but the OSD will show an error message.
POWER OFF	Red	Not in operation.

## Specifications and Parts

**Table 4 Specifications list**

<b>Parameter</b>	<b>Description</b>
LCD Type	Diagonal AM-TFT(Active-Matrix) Pixel pitch(mm): 0.264(H) 0.264(V) Brightness: 300cd/m <sup>2</sup> (Typical) Contrast Ratio: 1000:1(Typical) Viewing Angle: 160(H) x 160(V) Response Time: 5msec(Typical)
Resolution (H x V)	1280 x 1024 @ 60Hz
Frequency	Horizontal: 31-64KHz Vertical: 56-75Hz
Input Signal	Video(2ch input 1.0Vp-p, 75Ω terminated, loop-through out) SYNC(Separate TTL Level) S-Video(1ch input (Y/C), 75Ω terminated, loop-through out) AV(composite) Sound in PC Stereo Sound
Active Display Area (W x H)	17": 337.9mm(13.3") x 270.3mm(10.6") 19": 376.3mm(14.8") x 301mm(11.9")
Packing Dimensions (W x D x H)	17": 436mm(17.2") x 476mm(18.7") x 225mm(8.9") 19": 490mm(19.3") x 506mm(19.9") x 225mm(8.9")
Weight	17": Net Weight 6.2kg(13.7lb) Gross Weight 7.9kg(17.4lb) 19": Net Weight 6.6kg(14.6lb) Gross Weight 8.4kg(18.5lb)
Power Supply	DC 12V/ 4A

**Table 5 Parts list**

<b>Part</b>	<b>Quantity</b>
LCD Monitor	1
Power Cord	1
Remote Control Unit (with batteries)	1

**Table 5 Parts list**

<b>Part</b>	<b>Quantity</b>
Stereo Cable	1
VGA Cable	1
Power Adapter	1
User Manual	1

Note: technical specifications and parts are subject to change without notice.

## Troubleshooting

**Issue:** No image is displayed on screen.

- Possible Solution:**
- Check that the power cord has been connected securely into the wall outlet or grounded extension cable or surge protector.
  - Power switch should be in the ON position and the LED should be lit.
  - Check that the Brightness and the Contrast adjustments have not been turned down to the minimum levels.

**Issue:** 'Going to Sleep' message displayed on screen.

- Possible Solution:**
- The signal cable should be fully connected to the video card/computer.
  - The video card should be completely sealed in the slot and the computer is switched ON.

**Issue:** Display image is not centered, too small or too large in PC mode.

**Possible Solution:** Push the down key on the front of the monitor or the Auto button on the remote control.

**Issue:** Vertical or Horizontal noise is present in the picture.

**Possible Solution:** Adjust Clock and Phase in the OSD.



**NOTES:**

**Honeywell Video Systems (Head Office)**

2700 Blankenbaker Pkwy, Suite 150  
Louisville, KY 40299, USA  
[www.honeywellvideo.com](http://www.honeywellvideo.com)  
☎ +1.800.796.2288

**Honeywell Security Australia Pty Ltd.**

Unit 5, Riverside Centre, 24-28 River Road West  
Parramatta, NSW 2150, Australia  
[www.ademco.com.au](http://www.ademco.com.au)  
☎ +61.2.8837.9300

**Honeywell Security Asia Pacific**

33/F Tower A, City Center, 100 Zun Yi Road  
Shanghai 200051, China  
[www.security.honeywell.com/cn](http://www.security.honeywell.com/cn)  
☎ +86 21.2527.4568

**Honeywell Security Asia**

Flat A, 16/F, CDW Building, 388 Castle Peak Road  
Tsuen Wan, N.T., Hong Kong  
[www.security.honeywell.com/hk](http://www.security.honeywell.com/hk)  
☎ +852.2405.2323

**Honeywell Security France**

Parc Gutenberg, 8, Voie La Cardon  
91120, Palaiseau, France  
[www.honeywell.com/security/fr](http://www.honeywell.com/security/fr)  
☎ +33.01.64.53.80.40

**Honeywell Security Italia**

Via della Resistenza 53/59  
20090 Buccinasco Milan, Italy  
[www.honeywell.com/security/it](http://www.honeywell.com/security/it)  
☎ +39.02.48.88.05.51

**Honeywell Security España**

Mijancas 1. 3<sup>a</sup> Planta  
P.Ind. Las Mercedes  
28022 Madrid, Spain  
[www.security.honeywell.com/es](http://www.security.honeywell.com/es)  
☎ +34.902. 667.800

**Honeywell Video Systems Northern Europe**

Netwerk 121  
1446 WV Purmerend, The Netherlands  
[www.SecurityHouse.nl](http://www.SecurityHouse.nl)  
☎ +31.299.410.200

**Honeywell Video Systems UK Ltd.**

Aston Fields Road, Whitehouse Ind Est  
Runcorn, Cheshire, WA7 3DL, UK  
[www.honeywellvideo.com](http://www.honeywellvideo.com)  
☎ +0844 8000 235

**Honeywell Security South Africa**

Unit 6 Galaxy Park, 17 Galaxy Avenue  
Linbro Park, P.O. Box 59904  
2100 Kengray, Johannesburg, South Africa  
[www.honeywell.co.za](http://www.honeywell.co.za)  
☎ +27.11.574.2500

**Honeywell Security Deutschland**

Johannes-Mauthe-Straße 14  
D-72458 Albstadt, Germany  
[www.honeywell.com/security/de](http://www.honeywell.com/security/de)  
☎ +49.74 31.8 01.0

**Honeywell Security Poland**

Chmielewskiego 22a, 70-028  
Szczecin, Polska  
[www.ultrak.pl](http://www.ultrak.pl)  
☎ +48.91.485.40.60

**Honeywell Security Czech Republic**

Havránkova 33, Brno  
Dolní Heršpice, 619 00, Czech Republic  
[www.olympo.cz](http://www.olympo.cz)  
☎ +420.543.558.111

**Honeywell Security Slovakia Republic**

Vajnorská 142, 83104 Bratislava  
Slovakia  
[www.olympo.sk](http://www.olympo.sk)  
☎ +421.2.444.54.660

# Honeywell

[www.honeywellvideo.com](http://www.honeywellvideo.com)  
**+1.800.796.CCTV (North America only)**  
[HVSsupport@honeywell.com](mailto:HVSsupport@honeywell.com)

Document 800-00718 07/07 Rev A

© 2007 Honeywell International Inc. All rights reserved. No part of this publication may be reproduced by any means without written permission from Honeywell Video Systems. The information in this publication is believed to be accurate in all respects. However, Honeywell Video Systems cannot assume responsibility for any consequences resulting from the use thereof. The information contained herein is subject to change without notice. Revisions or new editions to this publication may be issued to incorporate such changes.

L39ME0118 Rev 0

## Free Manuals Download Website

<http://myh66.com>

<http://usermanuals.us>

<http://www.somanuals.com>

<http://www.4manuals.cc>

<http://www.manual-lib.com>

<http://www.404manual.com>

<http://www.luxmanual.com>

<http://aubethermostatmanual.com>

Golf course search by state

<http://golfingnear.com>

Email search by domain

<http://emailbydomain.com>

Auto manuals search

<http://auto.somanuals.com>

TV manuals search

<http://tv.somanuals.com>