

# S7999B, S7999C SOLA Local Operator Interface

## PRODUCT DATA

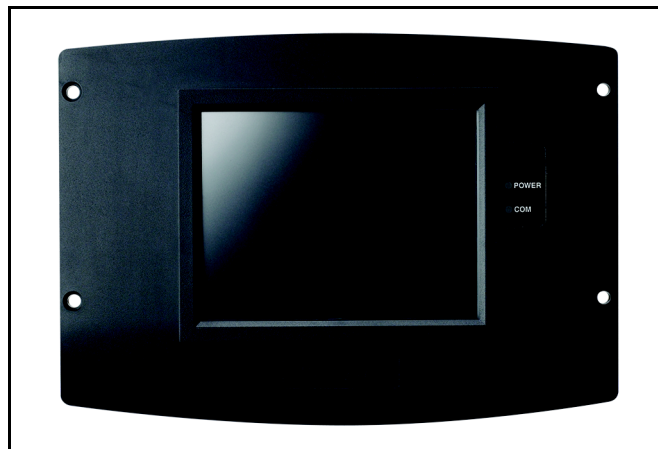

## APPLICATION

The S7999B and S7999C are microprocessor-based touch-screen Operator Interface (OI) displays that provide an operator interface for monitoring and configuring parameters in the Sola Hydronic Control and Sola Steam Control system.

The S7999B can be used to monitor an individual boiler but is primarily used for multiple boiler applications in a lead/lag arrangement. COM 2 port is available for Building Automation applications. The S7999B display is flush mounted into a panel cutout (8-1/8 in. W x 5-7/8 in. H). Wiring connections to the S7999B are through a removable 9-pin wiring header.

The S7999C display is used for individual boiler monitoring. The S7999C is mounted:

- onto a panel using the wallplate provided.
- from the front into a panel cutout (7.6 in. W X 5.4 in. H) using 4 #6-32 screws and nuts (provided).

- From behind into a panel cutout (5.45 in. W X 4.3 in. H) using 4 #6-32 screws, nuts and 4 standoffs (provided).

Wiring connections to the S7999C are made via a 4-pin connector on the back of the display.

NOTE: If display S7999B is used to monitor a lead/lag system, display S7999C can NOT be used.

## FEATURES

- **Individual boiler status, configuration, history, and diagnostics.**
- **Allows configuration and monitoring of the Sola Controls (R7910A Hydronic Controls or R7911 Steam Control) burner control sequence, flame signal, diagnostics, historical files, and faults.**
- **S7999B OI Display only:**
  - Allows switching view between multiple boilers
  - Allows viewing Lead-Lag Master
  - Ethernet port for downloading software upgrades (when required)
  - Real-time data trending analysis and transferring saved trend data to Excel spreadsheet.
  - Audible Alarm
  - COM 2 Modbus port for Building Automation System applications.
  - LED indicators:
    - Power
    - Network
    - COM 2
    - COM 1
  - Models available:
    - S7999B1026 has Blue Border
    - S7999B1067 has Black Border
- **S7999C OI Display only:**

## Contents

Preface .....	2
Specifications .....	3
Installation Instructions (S7999B OI Display) .....	4
Wiring (S7999B OI Display) .....	4
Starting the S7999B OI Display .....	7
Configuration .....	20
Details .....	38
R7910A or R7911 Diagnostics .....	44
S7999B or S7999C Display Setup and Diagnostics .....	47
Advanced Setup .....	48
Table 61 Configurable Parameters. ....	53
Table 62 Other Tables. ....	61



65-0303-05

- MMC Port for installing software upgrades (when required)
- LED indicators:
  - Power
  - COM
- Models available:
  - S7999C1008 has white border
  - S7999C1016 has blue border
  - S7999C1040 has black border
- **Allows for lead/lag commissioning.**
- **Locates attached boiler(s).**
- **Allows boiler naming.**
- **Color 3.5 in. x 4.625 in. (5.7 in. diagonal) user interface display.**
- **Graphic user interface.**
- **Touch screen.**
- **Communication between the OI Displays and the SOLA Controls uses Modbus™.**
- **LED indicators (S7999C):**
  - Power
  - COM
- **Flush mounting.**
- **Touch screen disable for screen cleaning.**
- **12 Vdc power supply (included).**
- **Screen saver.**
- **Contrast control.**
- **Volume control.**

## PREFACE

This User Guide is intended to provide a general overview of the S7999B or S7999C Operator Interface (OI) Displays. The general overview goes to page 20 and the actual configuration begins on page 20.

It is intended to guide you through the features and operation of the OI Display as you interface with the R7910A or R7911 Sola control and establish the Parameter points of the system.

Note that this sheet shows all parameters. The actual product may have parameters made invisible or Read Only by Honeywell as they may not apply to the product.

## ORDERING INFORMATION

When purchasing replacement and modernization products from your TRADELINE® wholesaler or distributor, refer to the TRADELINE® Catalog or price sheets for complete ordering number.

If you have additional questions, need further information, or would like to comment on our products or services, please write or phone:

1. Your local Honeywell Automation and Control Products Sales Office (check white pages of your phone directory).
2. Honeywell Customer Care  
1885 Douglas Drive North  
Minneapolis, Minnesota 55422-4386

In Canada—Honeywell Limited/Honeywell Limitée, 35 Dynamic Drive, Toronto, Ontario M1V 4Z9.

International Sales and Service Offices in all principal cities of the world. Manufacturing in Australia, Canada, Finland, France, Germany, Japan, Mexico, Netherlands, Spain, Taiwan, United Kingdom, U.S.A.

Use the Product Data Sheet for the Sola Controls (form 65-0303) as a guide and explanation of the parameters that are being programmed.

## SOFTWARE UPGRADE

### S7999B Only

You can download new software for the OI Display through the Internet. Downloading software should only be done when recommended by Honeywell. This feature is intended to permit field upgrades for bug fixes and to install new features.

Requirements for downloading new software:

- Ethernet connection for Internet access (RJ45 male connector). Carefully insert the RJ45 connector into the Ethernet jack in the lower right corner on the back of the display to ensure no damage to the jack.
- Dynamic IP addressing (from DHCP server).

#### **IMPORTANT**

*If these requirements can't be met at the location of the OI Display, this procedure should not be done or the OI Display should be moved to a location where these requirements can be met. Failure to satisfy these requirements can result in the OI Display becoming inoperable when the upgrade steps are followed.*

The above requirements can be checked prior to execution of the software upgrade procedure on the Ethernet Setup page (see Advanced Setup section). On the Ethernet Setup page a connectivity check can be performed to validate whether access to the Honeywell server is possible.

The OI Display must be reset to initiate the download procedure. Initial boot procedure of the device permits the user to enter into Advanced Startup options within the first five seconds after power up.

Follow these steps:

1. Select the Advanced Startup Options button. A Warning message is displayed. If you don't want to proceed with the software upgrade, you can cancel the procedure at this time.
2. Select OK to proceed.
3. Select the "Force Application Update" checkbox.
4. Deselect the "Use Existing Application" checkbox.
5. Select the Continue button.

The software upgrade is automatic after the above steps. The OI Display connects to the Honeywell server, which verifies the configuration file, erases the old application and downloads the new one.

The OI Display may have difficulty finding the new configuration file at first. In this case, the procedure automatically starts over again until it works.

### S7999C Only

Software upgrades for S7999C OI Display (when needed) will be provided by Honeywell and are accomplished through the MMC port located on the top back of the device.

## SPECIFICATIONS

### Electrical Ratings:

+12 Vdc input, maximum of 500 mA current drain.

Included Power Supply for S7999B:

Inputs: 85 to 264 Vac, 47 to 63 Hz; 120 to 370 Vdc.

Output: 12 Vdc; 0 to 2.1 A.

Power: 25 W.

Included Power Supply for S7999C:

Inputs: 100 to 240 Vac.

Output: 12 Vdc; 0.42 A.

Power: 25 W.

**Operating Temperature:** 32°F to 122°F (0°C to 50°C)

**Storage/Shipping Temperature:** -40°F to 158°F (-40°C to 70°C).

### Humidity:

85% maximum relative humidity.

### Approvals:

FCC Part 15, Class A Digital Device

Underwriter's Laboratories, Inc. (UL) (cUL) Component

Recognized (for non-continuous operation): File Number

MH20613 (MCCZ)

Canada: ICES-003

**Dimensions:** See Fig. 1.

### Replacement Parts (S7999B)

- 9-pin connector—50020034-001
- Power Supply—Manufactured by MeanWell, Model S-25-12 (order from manufacturer).
- #6-32 X1-in. screws(4) with nuts (4)

### Supplied Parts (S7999C)

- Mounting Plate - see Fig. 9 for dimensions and hole locations.
- #6-32 X 1-in. screws (4) with nuts (4)
- Standoffs 5/16-in. dia. X 3/8 in. long (4)
- Power Supply—Manufactured by V-infinity Model FSC-S5-12U (order from manufacturer).

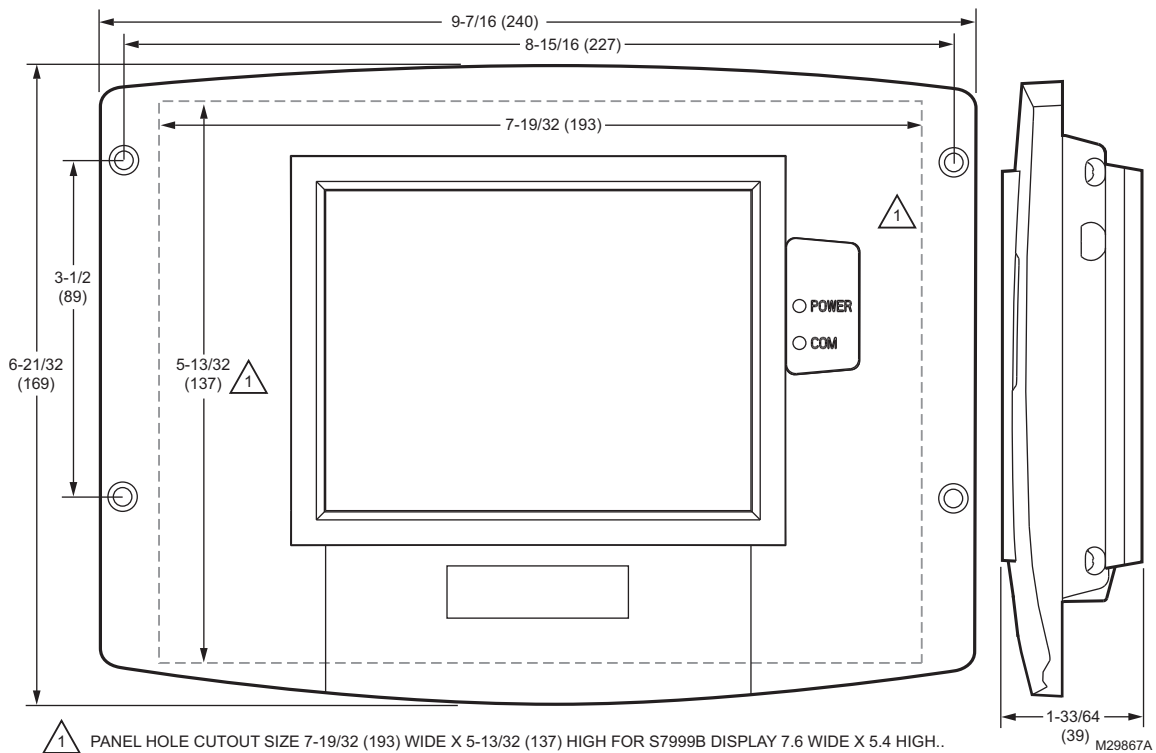

**Fig. 1. OI Display dimensions (S7999C shown) in in. (mm).**

**NOTE:** This equipment has been tested and found to comply with the limits for a Class A digital device, pursuant to part 15 of the FCC Rules. These limits are designed to provide reasonable protection against harmful interference when the equipment is operated in a commercial environment. This equipment generates, uses and can radiate radio frequency energy and, if not installed and used in accordance with the instruction manual, may cause harmful interference to radio communications. Operation of this equipment in a residential area is likely to cause harmful interference in which case the user will be

required to correct the interference at his own expense.

This Class A digital apparatus complies with Canadian ICES-003.  
Cet Appareil numérique de la classe A est conforme à la norme NMB-003 du Canada.

## SAFETY FEATURES

The OI Displays contain software that incorporates many features that are designed to guide you safely through the commissioning process. Safety, however, is your responsibility.

Read all documentation carefully and respond appropriately to all error messages.

### **! WARNING**

**Explosion Hazard.**  
Improper configuration can cause fuel buildup and explosion.

Improper user operation may result in PROPERTY LOSS, PHYSICAL INJURY or DEATH.

Using the OI Displays to change parameters, must be attempted by **only experienced and/or licensed burner/boiler operators and mechanics.**

## INSTALLATION INSTRUCTIONS (S7999B OI DISPLAY)

NOTE: For S7999C OI Display installation instructions, see page 9.

### Mounting the S7999B OI Display and Power Supply

The OI Display can be mounted on the door panel of an electrical enclosure.

1. Select the location on the door panel to mount the display; note that the device will extend into the enclosure at least one inch past the mounting surface.
2. Provide an opening in the panel door 8-1/8 in. wide by 5-7/8 in. high.
3. Place the OI Display in the opening and use it as a template to mark the location of the four mounting screw holes. Remove the device.
4. Using pilot holes as guides, drill 1/4 in. holes through the door panel.
5. Place the display in the opening, aligning the mounting holes in the device with the drilled holes in the panel.
6. Secure the display to the panel with four #6-32 screws and nuts provided.

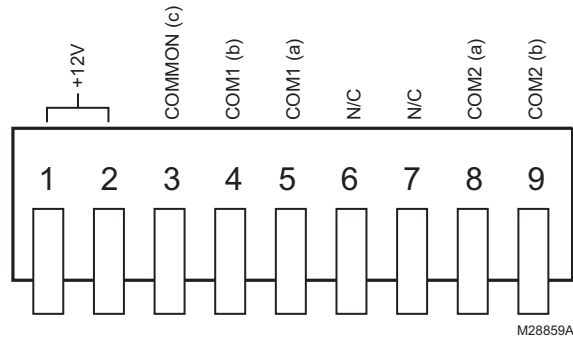

Fig. 2. S7999B OI Display connector terminals.

7. Select a location inside the enclosure for mounting the power supply.
8. Using the power supply as a template, mark the locations of the two mounting holes in the enclosure.
9. Remove the power supply.
10. Drill 1/4 in. holes through the panel at the marked locations and secure the power supply with the two #6-32 screws and nuts provided.
11. Remove the 9-pin connector plug from the back of the OI Display.
12. Wire the connector to the power supply and the RS-485 cables using the wiring diagram in Fig. 3.
13. Ensure the 9-pin connector plug is aligned with the header pins when inserting the 9-pin connector plug back onto the Display. Secure firmly.

## WIRING (S7999B OI DISPLAY)

The S7999B OI Display must be appropriately wired for both power and communications. An external 12V power supply (provided) with an appropriate power rating is connected to pins 1, 2 and 3 to power the device.

Communication is done over a RS-485 bus:

- COM1 connected directly to the SOLA Device J3 connector to either Modbus (MB1 or MB2).
- COM2: A bus to the Building Automation System.

See Fig. 2 for S7999B Display connector terminals. Wiring connections are listed in Table 1. See Fig. 3 for wiring.

Table 1. 9-pin Connector Terminals

Pin #	Function
1	12V input
2	12V input
3	Common (Power, COM 1)
4	COM 1 (b) to MB1 or MB2 terminal
5	COM 1 (a) to MB1 or MB2 terminal
6	Not used
7	Not used
8	COM 2 (a)

Table 1. 9-pin Connector Terminals

Pin #	Function
9	COM 2 (b)

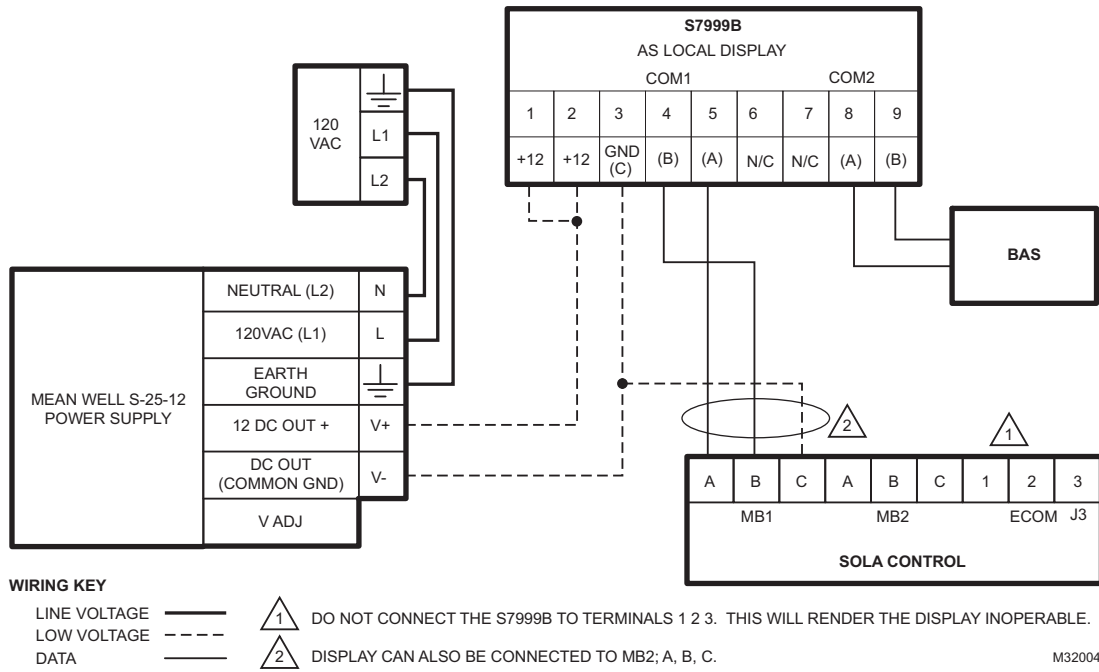

Fig. 3. S7999B wiring diagram.

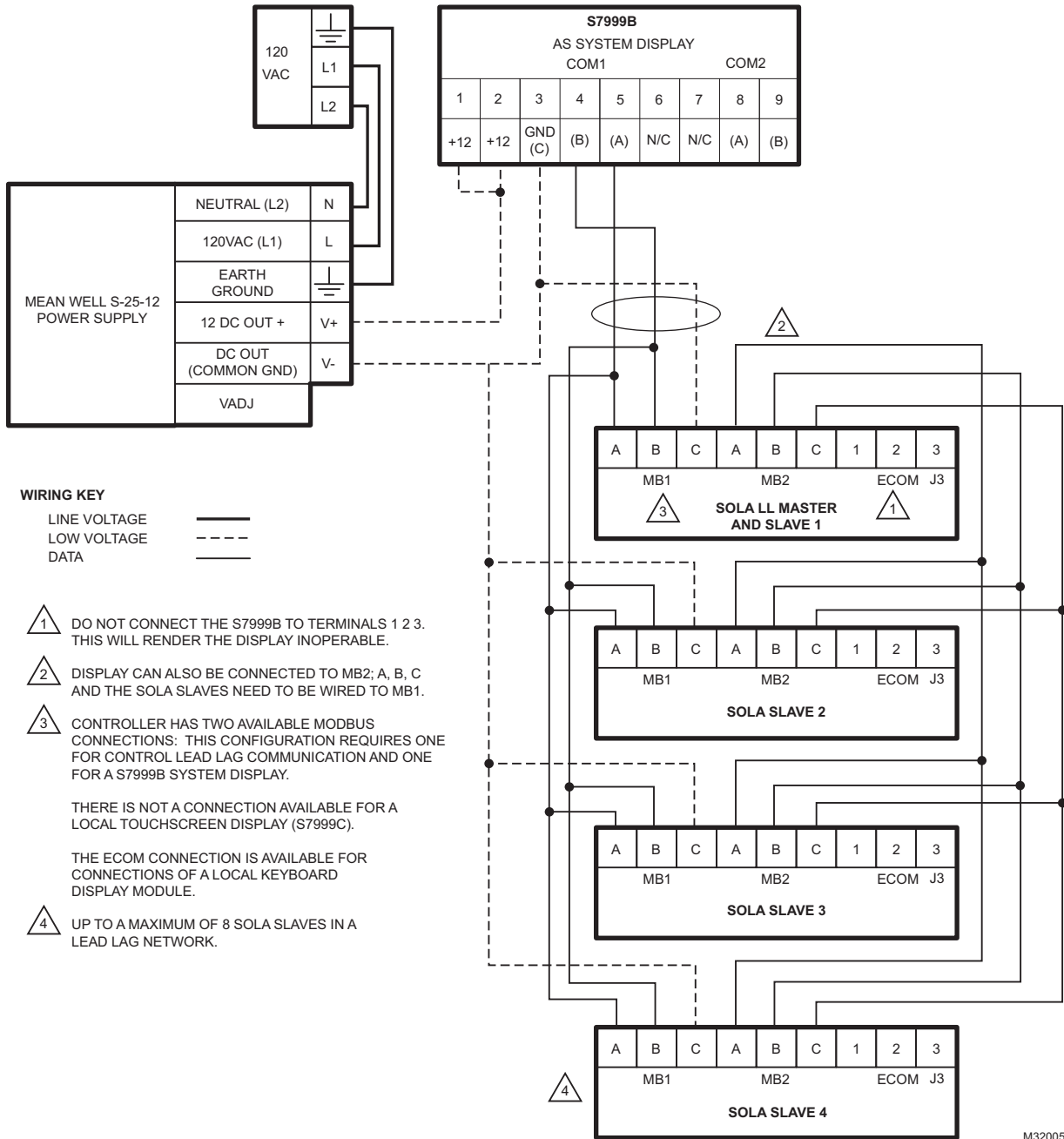
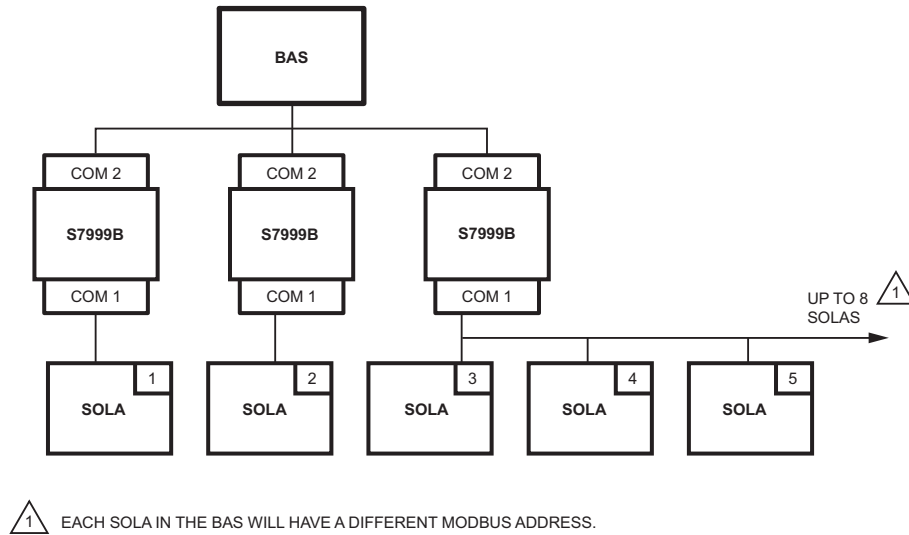

Fig. 4. S7999B wiring diagram for lead lag.

## BUILDING AUTOMATION SYSTEM (BAS) CONFIGURATION

Connect the BAS Modbus wiring to COM2 of the S7999B as shown in Fig. 5.

Ensure all S7999B devices have unique Modbus addresses as defined in Fig. 5.



M32006

**Fig. 5. S7999B in a Building Automation System.**

BAS Modbus message timeout should be set to 1.0 seconds or higher. This means it could take up to 1.0 seconds (max) for the System Display to reply to a BAS message.

**Retries:** BAS must setup retries upon timeout to ensure the Modbus request is accepted.

BAS Modbus poll rate should be set to 1.0 seconds. This means that the BAS should wait for a minimum of 1.0 seconds after receiving a Modbus message from Sola before sending a new Modbus message.

## QUICK SETUP (S7999B OI DISPLAY)

1. Make sure the S7999B 9-pin connector is properly aligned and pressed firmly in place.
2. Make sure the wires between the 9-pin connector and the controller are properly wired and secure.

## WARNING

**Electrical Shock Hazard.**  
Can cause severe injury, death or equipment damage.

Line voltage is present at the 120 Vac power supply.

3. Make sure the power supply is connected securely to the 120 Vac power source.

## STARTING THE S7999B OI DISPLAY

### Power-up Validation

The Home page will appear and the "Power" LED will be blinking when the device is properly powered. Select the 1234 Setup button to adjust the contrast and sound as desired.

If the screen is dim, check the pin 1 and 2 wiring connections.

**NOTE:** An Advanced Startup screen displays for five seconds after power-up before the Home page displays. This screen allows the user to upgrade the software in the System Display (see "Preface" on page 2) and should normally be bypassed.

Three LEDs exist for I/O traffic: one for the Ethernet network port and two for Modbus™ ports. The ethernet port should only be used if instructed by Honeywell that an update is necessary. Modbus Com Port 2 is not active on this device.

1. Make sure the Power and COM1 LEDs are blinking.
2. If the LEDs are not blinking:
  - a. Make sure the proper connections have been made between the Modbus COM1 Port and the first controller device in the Modbus network.
  - b. See "Wiring (S7999B OI Display)" on page 4 for proper wiring of the OI Display 9-pin Header Connections.
3. If connected to a BAS application, COM2 LED will blink indicating BAS traffic.

### Home Page (S7999B OI Display)

Make sure a screen similar to Fig. 6 appears after the OI Display has completely powered up.

On System applications, each SOLA Control is represented on the Home page by an icon and name. Pressing the icon allows the user to zoom in on that boiler and see its specific details. These details are provided on a new page, which can include additional buttons that display additional detail and operation information, which itself leads to other pages. The pages are traversed in a tree structure method, as shown in Fig. 8.

The Sola icons will appear in one of four colors indicating the boiler status.

- **Blue:** Normal operation
- **Red:** Lockout condition
- **Gray:** Standby mode (burner switch off)

- **Gray and crossed out:** communication error (disconnected or powered off)

Up to 8 Systems can be displayed on the Home page. The name of each boiler is displayed next to the Sola icon button. When Lead Lag is enabled, the system header temperature and firing rate are displayed for each System. When the burner is in standby or not firing the firing rate is not displayed.

NOTE: The boiler name may be cut off on the Home page when all icons are present.

The Home page also includes a System Analysis button that allows the user to view status information on a system-wide (that is, multiple boiler) basis. The user can choose which status information to compare from the SOLA Controls in the system.

Pressing the 1 2 3 4 Setup button on the Home page displays miscellaneous setup and diagnostic functions beginning on page 47 (see also Table 61 on page 53). It also contains the setup configuration for BAS applications, under the Advanced Setup button.

Pressing the SOLA icon opens that control's status page. Go to "Configure Button" on page 13 to continue.



Fig. 6. S7999B Home page (Boiler 1 in normal operation).

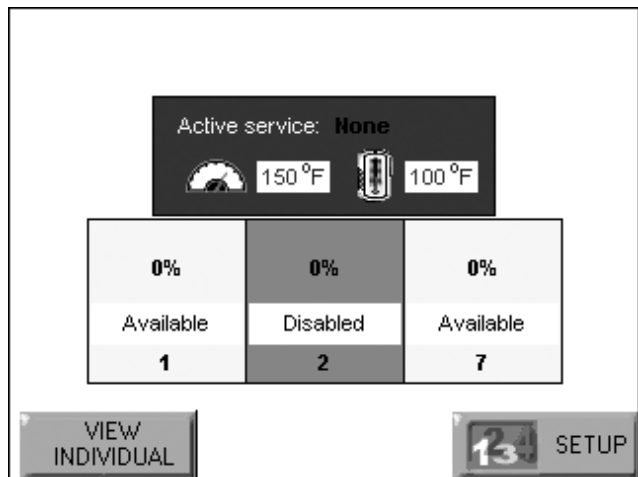

Fig. 7. S7999B Lead Lag Home page.



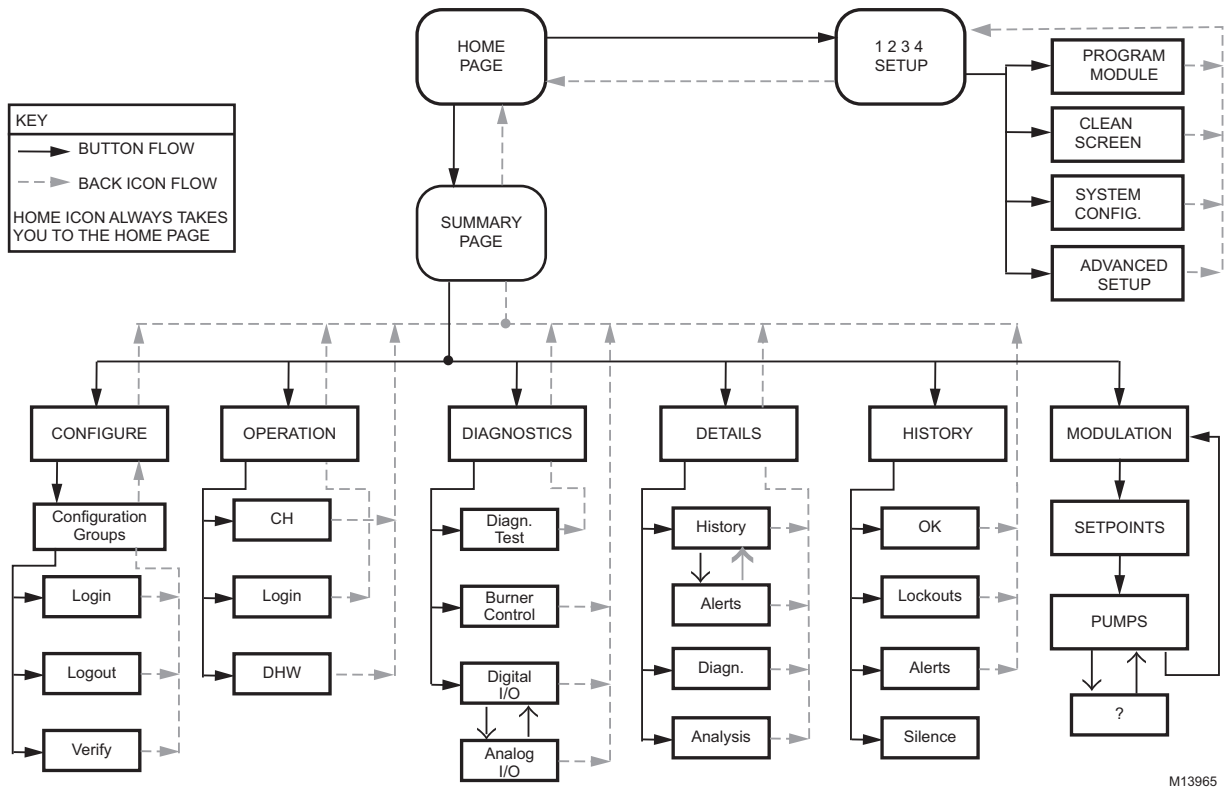

Fig. 8. S7999B display page flow.

## INSTALLATION INSTRUCTIONS (S7999C OI DISPLAY)

NOTE: For S7999B OI Display installation instructions, see page 4.

The S7999C display is used for individual boiler monitoring. The S7999C is mounted:

- onto a panel using the wallplate provided.
- from the front into a panel cutout (7.6 in. W X 5.4 in. H) using 4 #6-32 screws and nuts (provided).
- From behind into a panel cutout (5.45 in. W X 4.3 in. H) using 4 #6-32 screws, nuts and 4 standoffs (provided).

### Mounting the S7999C OI Display using the wallplate (provided)

1. Select the location to mount the OI display; this could be a location up to 1000 feet from the SOLA control.
2. Use the device wallplate as a template to mark the location of three or four mounting screw holes. See Fig. 9.
3. Drill 3/16 in. holes for mounting the wallplate.
4. Secure the wallplate with three or four #6-32 screws.
5. Bring power and communication wire through the wall plate and attach to the terminals on the back of the display before installing the display to the wall plate.

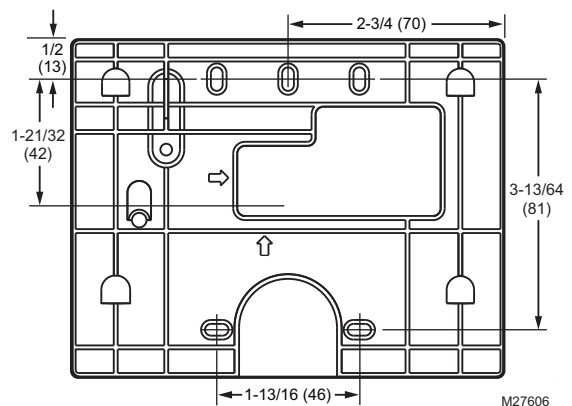

Fig. 9. S7999C wallplate dimensions in in. (mm).

### Mounting the S7999C OI Display directly to the Door Panel

1. Select the location to mount the display.
2. Cut an opening to facilitate mounting the display into the door panel. See Fig. 1 for the dimensions for mounting the display from the front of the door. See Fig. 10 for mounting the display to the back of the door. If desired, cut a notch so the LEDs will be visible as well. Tear off templates are also available on the back pages of this Manual (see Fig. 121 on page 63 and Fig. 122 on page 65).
3. Fit the display into the opening and use the screw holes in the device as a template to mark the location of the four mounting screw holes.

- Drill 3/16 in. holes for mounting the display.
- Secure the OI Display to the panel using the four #6-32 screws and nuts, as shown in Fig. 10. (Standoffs are provided for mounting the OI Display from the back of the door.)

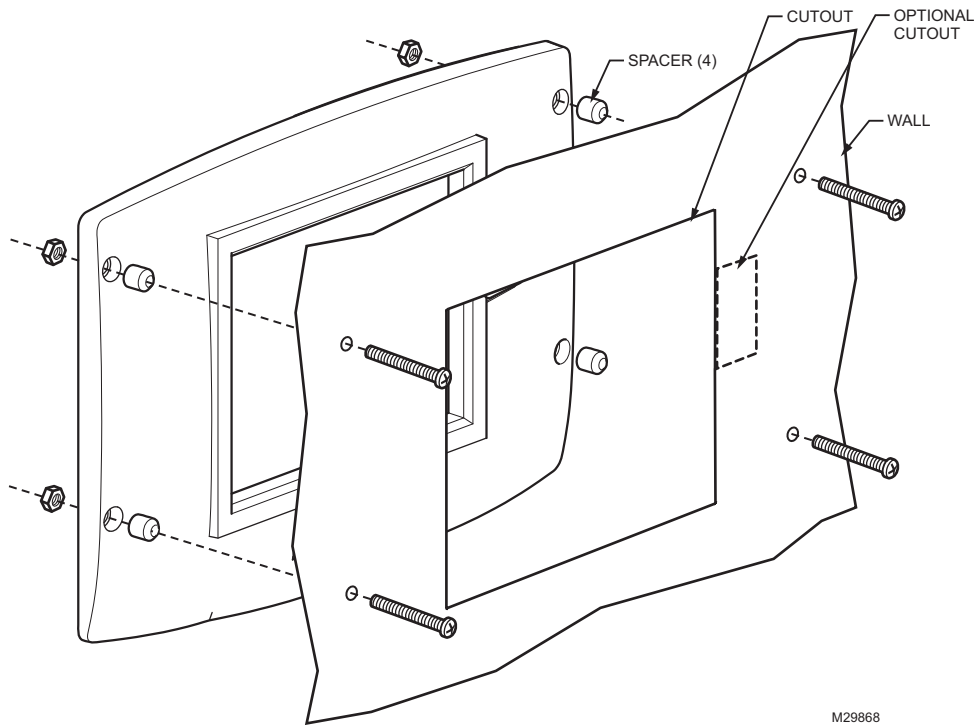

Fig. 10. Mounting the S7999C OI Display behind the door panel.

### S7999C OI Display Power supply mounting.

- Select a location inside the enclosure for mounting the power supply.
- Using the power supply as a template, mark the locations of two mounting holes in the enclosure.
- Remove the power supply.
- Drill 1/4 in. holes through the panel at the marked locations and secure the power supply with the two #6-32 screws and nuts provided.

### WIRING (S7999C OI DISPLAY)

The S7999C OI display must be appropriately wired for both power and communications.

- Wire the power supply and the RS-485 communication cables per Table 2 and the wiring diagram in Fig. 11.
  - Y and G are connected directly to the display and either SOLA Control connector J3 Modbus (MB1) or Modbus (MB2).
- Make sure the 12 Vdc power supply (supplied with the S7999C) is connected securely to the 120 Vac power source.

Table 2. 4-pin Connector Terminals (located on the back of the S7999C OI Display).

Pin #	Function
Y	Data (-) Output (Modbus b)

Table 2. 4-pin Connector Terminals (located on the back of the S7999C OI Display).

Pin #	Function
+	12Vdc input
-	12Vdc Input
G	Data (+) Output (Modbus a)

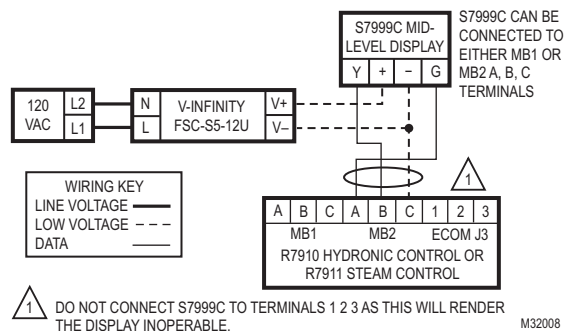
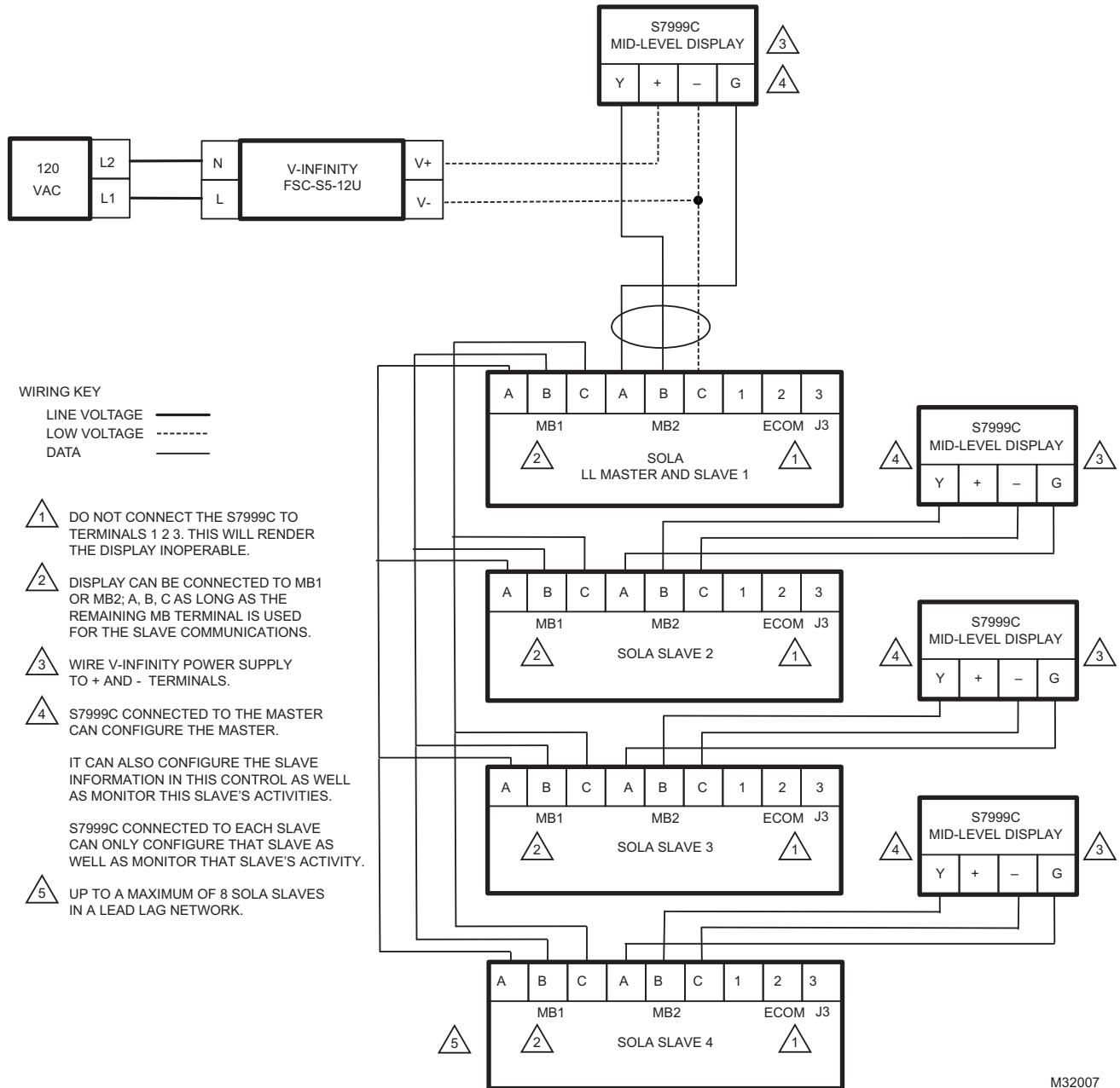

Fig. 11. S7999C wiring diagram.

**WARNING**  
**Electrical Shock Hazard.**  
**Can cause severe injury, death or equipment damage.**  
 Line voltage is present at the power supply.



M32007

**Fig. 12. S7999C wiring diagram for lead lag.**

# STARTING THE S7999C OI DISPLAY

## Power-up Validation

The Home page will appear and the “Power” LED will be on continuously and the “COM” LED will be blinking when the device is properly powered and communicating to the Sola Control.

The “COM” LED exists for I/O traffic.

1. Make sure the LED is blinking.
2. If the LED is not blinking:
  - a. Make sure the proper connections have been made between the display and the Sola Control.
  - b. See “Wiring (S7999C OI Display)” on page 10 for proper wiring of the display connections.

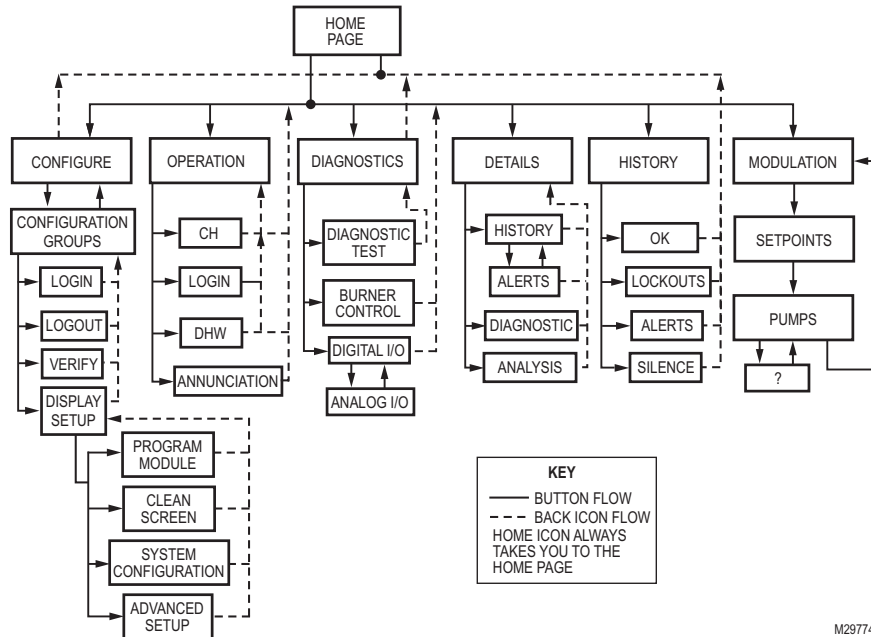



Fig. 13. S7999C display page flow.

## PAGE NAVIGATION

The Sola OI Displays present information and options in a paged manner. Pages are displayed in a tree structure in which the user navigates up and down to arrive at the desired Function (see Fig. 8 for S7999B or Fig. 13 for S7999C). The page descriptions are provided below so that you can understand the purpose of each and view the selections, parameters, and information that is available or required on each.

## Common OI Display Page Symbols

Most pages have a Home button  in the top-left corner of the screen and a Back button  in the top-right corner of the screen. The Home button returns the user to the Home page and terminates any operation in progress. The Back button returns the user to the previous page.

Two other icons may be noticed near the boiler name.

A bell  will be displayed if the system is in Lockout that reset will be required.

A padlock  will be shown on screens that require a password to change the parameter. An unlocked padlock indicates the password has been entered to change the parameter.

## Status or Home Page

A status (summary) page (Fig. 14) is displayed when the S7999C display is connected. This status page appears on the S7999B when the Sola control icon is pressed on the “Home” page. The status page displays the current condition of the burner control and displays some of the more important configuration settings.

The boiler name associated with the burner control is displayed in the title on the status page.

NOTE: When the burner control has no boiler name defined, Modbus address is used to identify the boiler.

The initial status page displayed contains summary status information as shown in Fig. 14. Any status information not applicable for the installation is grayed/blanked out on the screen.

Buttons on this screen include:

- **Configure:** used to configure the burner control (see “Configure Button” on page 13 for more details).
- **Operation:** used to perform daily or frequent functions with the burner control, such as setpoint adjustment, etc. See “Operation Button” on page 18 for details.
- **Diagnostic:** used to view burner control diagnostic information (see “Diagnostics Button” on page 19 for more details).
- **Details:** used to view burner control detail status information (see “Details” on page 38).

- **History:** used to view burner control history (see “History Button” on page 16 for more details).
- **?:** used to expand the pump status information.
- **Modulation:** used to toggle between status displays: pump, setpoints, and modulation.

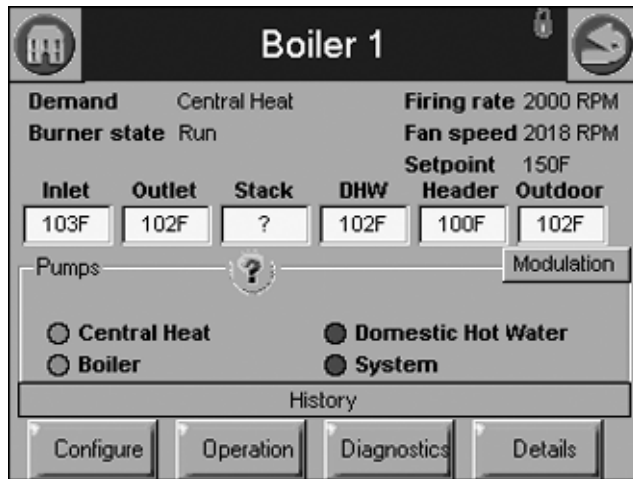

Fig. 14. Summary status page (Hydronic Control shown).

## Configure Button

Pressing the Configure button (bottom left) on the Status page opens the Configuration page. The Configuration page shown in Fig. 15 is for the S7999C OI display.

The S7999B Configuration page does not have a “Display Setup” button.

**Display Setup** (S7999C only): Pressing the Display Setup button displays miscellaneous S7999C OI Display setup and diagnostic functions (See page 47 for options). (The same function as the 1234 Setup on the S7999B home page.)

The configuration page allows the user to view and set parameters that define how the connected R7910A functions in the hydronic heating system or the R7911 steam heating system.

The configuration page contains a menu of parameters grouped into functional areas that the user selects for configuration (see Fig. 16). See Table 61 on page 53 for all parameters available for configuration. If some parameters are not visible, they have been made invisible by Honeywell.

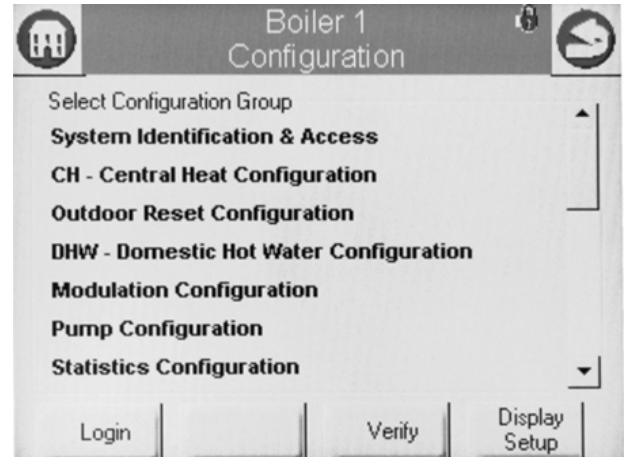

Fig. 15. Configuration menu page. Shown is the S7999C on a Hydronic Control.

No specific order for configuration is required. All parameters are enabled for editing, though some may not be applicable (e.g., a configuration parameter may disable a control feature). Selecting a parameter group from the menu displays parameters exclusively applicable for the functional group on the page (see Fig. 16). These parameters can be edited, and when the user is finished, control returns back to the configuration menu page.

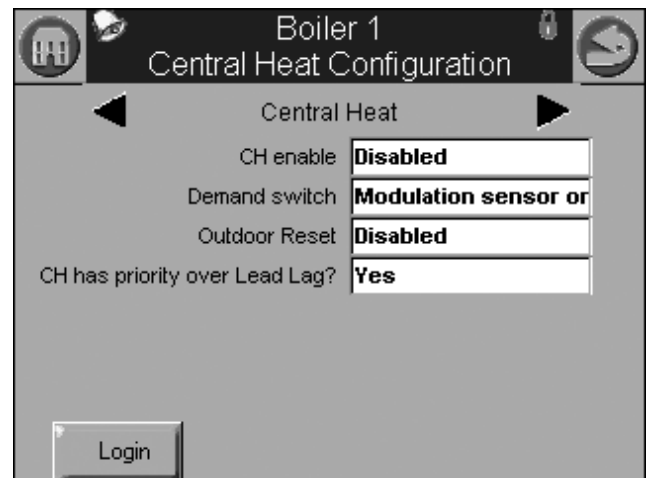

Fig. 16. Sample configuration page for the S7999B Hydronic Control.

Each parameter is displayed in its group. If there are more parameters than will fit on the screen, a vertical scroll bar allows the user to scroll up and down to view all parameters. The parameter name is displayed on the left and the current setting is displayed in the text box on the right.

## Configuration Password

Some parameters require a valid configuration password be entered by the user before the parameter can be changed. The password need only be entered once while the user remains on the configuration pages. Leaving the configuration pages ends the scope of the password.

Three levels of access to Sola Control parameters are permitted. Each access level has defined rights when interfacing with configuration and status parameters within the controls.

- **End user:** The end user can read or view the control parameters and be allowed to change some operating parameters, CH setpoint as an example.
- **Installer:** The installer can read all control parameters and change Honeywell's allowed parameters. This access level is used to customize the control for a particular installation.
- **OEM:** The OEM can read and change all parameters, change sensor limits and burner control safety parameters.

Different passwords exist in the Sola Control for each access level. The end user level requires no password, but the installer and OEM levels have unique passwords defined for them.

The installer and OEM passwords can be changed in the Sola Control after logging in with the current password. When the password is changed, it is saved for all future logins.

**NOTE: For the S7999B System OI display,** each boiler in a multi-boiler configuration has its own set of installer and OEM passwords. To avoid user confusion, the passwords should be changed to the same password in each control, but there is no requirement to do so. **Make sure to record your password.**

The user is notified that a new password is needed to change a parameter (or until a password is entered successfully)—see Fig. 17. The user can continue viewing the configuration parameters regardless of whether a password is entered successfully.

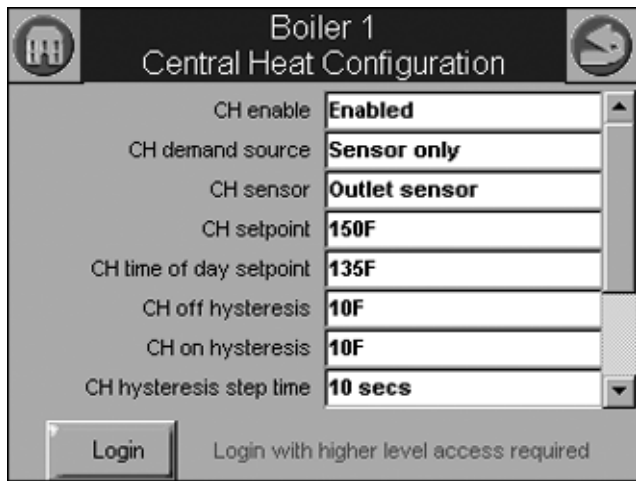

Fig. 17. Login required. (S7999B Hydronic Control Shown.)

The Sola Controls maintain a password time-out that limits the scope of the password entry. Once a password is successfully entered, the control starts an internal timer that expires after 10 minutes of inactivity. After the timer expires, the user is required to re-enter a password before a parameter can be changed.

The user is not required to enter a configuration password for a parameter that has a lower access level than the access level achieved by an earlier password entry for any configuration group (as long as the user stays in the configuration pages). The user only needs to enter a password once until a parameter that has a higher access level is selected.

## Keyboard

Some pages request user entry of characters. When this type of input is required, a keyboard page appears, as shown in Fig. 18. The text box at the top of the screen displays the current (or default) setting of the user input. The user can add to this text, clear it, or change it.

The Shift key on the left side of the screen shifts between upper and lowercase characters. Pressing the Shift key toggles the keyboard from one mode to the other (continuous pressing of the Shift button is not required). The OK button should be pressed when the user is done entering the text input. The Cancel button on the bottom of the screen allows the user to ignore any text changes that have been made and keep the original text value. Pressing the OK or Cancel buttons returns the user to the page displayed prior to the keyboard page.

## Login

Pressing the Login button allows entering the password from a keyboard as shown in Fig. 18. After the password is entered, the OK button is selected. The Cancel button aborts the password login.

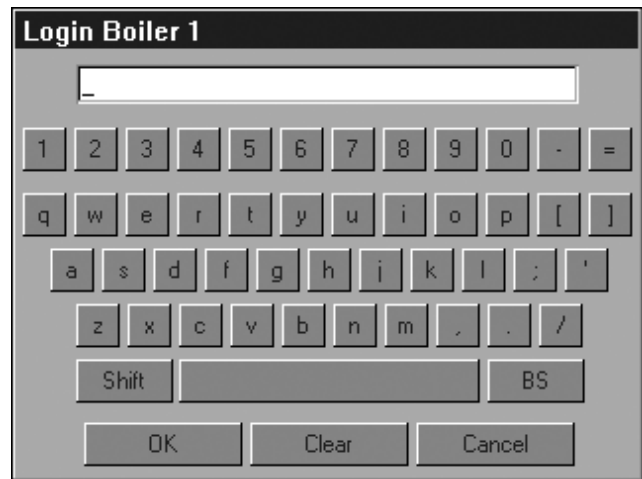

Fig. 18. Device login screen.

## ⚠ WARNING

**Explosion Hazard.**  
**Improper configuration can cause fuel buildup and explosion.**  
 Improper user operation may result in PROPERTY LOSS, PHYSICAL INJURY or DEATH.

Using the OI Displays to change parameters must be attempted by **only experienced and/or licensed burner/boiler operators and mechanics.**

## Change Parameter Settings

Change parameter settings by selecting the parameter on the page. A dialog box displays for the parameter with controls allowing the user to change the value (see Fig. 19). After changing the setting to a new value, press the OK button. Pressing the Cancel button leaves the parameter unchanged.

The changed setting is reflected on the screen and sent to the control when the OK button is pressed.

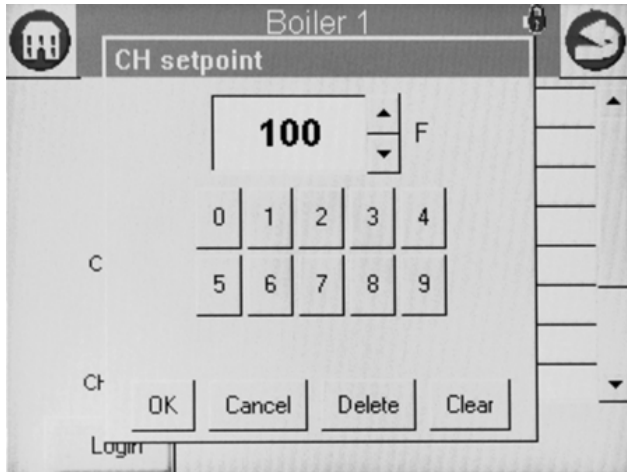

Fig. 19. Change configuration parameter page example of a Hydronic Control.

## Verify

Pressing the Verify button displays safety configuration parameters for an additional verification step to commit the changes.

Safety parameters are grouped into blocks that include only safety parameters, not a mixture of safety data and non-safety data. All parameters within the safety group undergo a verification process. A safety parameter group is identified on the display to indicate when the configuration parameters are safety-related. Each safety parameter group is verified one at a time until all have been verified. See Fig. 20.

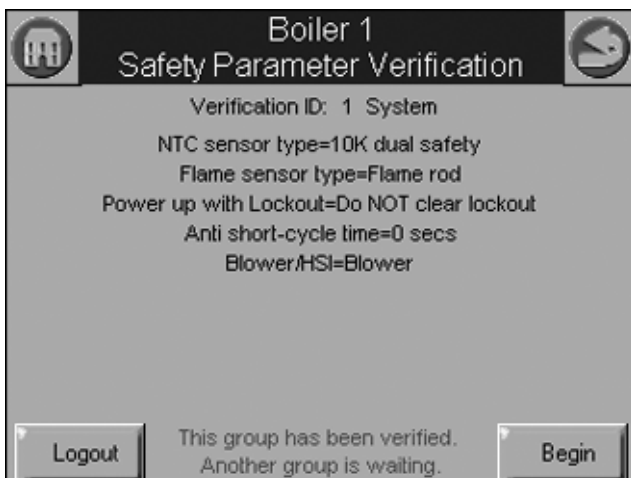

Fig. 20. Safety verification.

Like operating parameters, safety parameters can be viewed without the need to enter a password.

Safety parameter blocks that have been changed require verification. The verification steps do not have to be completed immediately; the installer can move between and change parameter groups before the verification is done. A Verify button is enabled that allows the installer to conduct verification sessions (the example of the Verify button in Fig. 15 is not yet enabled because the installer hasn't logged in).

**NOTE:** When the installer proceeds with the safety parameter configuration, the control unlocks the safety parameters in this group and marks them unusable. Failure to complete the entire safety configuration procedure leaves the control in an un-runnable state (lockout 2).

All safety configuration parameters in the group should have the same access level. If this condition isn't so, the user is asked to enter another password when a higher access level is needed.

Successful login is noted by the lock icon, which changes to "unlocked" on the page. The installer may begin to change safety parameters (or any other parameters) at that time. (See Fig. 21.) If the Sola Control is in an unconfigured (or new) state, then this warning doesn't appear. All parameters that need changes should be changed during the login.



Fig. 21. Edit safety data.

If the safety configuration session is terminated after it has started (in the Edit or Verify stages), the Sola Control is left in an unconfigured (unrunnable) state.

The installer can terminate the session by pressing the Menu button or by attempting to leave the Verification page with the Home or Back buttons (top-left and -right screen corners, respectively). However, leaving the session at this point leaves the control in an unrunnable state and confirms whether the installer still wants to do so.

The settings of all parameters in each safety block must be verified to save them in the control.

When the installer is done changing safety parameters, pressing the Verify button on the configuration screen begins the Verification process. The settings for all safety parameters in each changed block are presented and Verified by the installer (see Fig. 22).

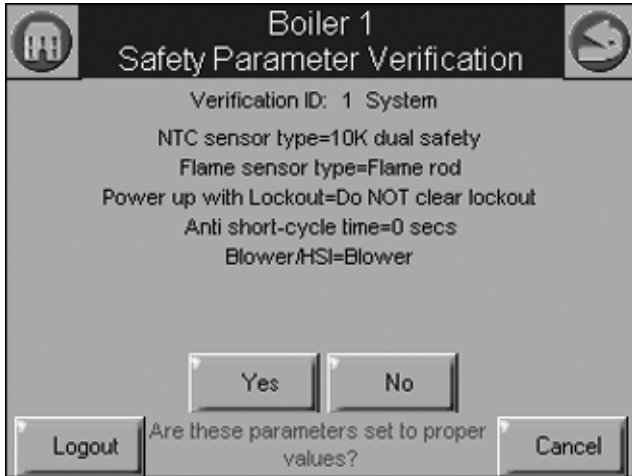

**Fig. 22. Safety parameter confirmation.**

Press the Yes button to confirm each safety parameter block. If the No button is selected, the safety parameter block remains unconfirmed and the Configuration menu page is displayed. The control remains in an unconfigured state in this case.

After all safety parameter blocks have been confirmed, the installer is asked to press and hold the Reset button on the Sola Control to complete the safety verification session (see Fig. 23).



**Fig. 23. Safety parameter reset.**

When the Reset button is pressed and held for 3 seconds the confirmed safety parameters are saved in the control. The above Reset dialog box automatically closes when this step is completed.

If this step is not performed, the control remains in a safety lockout state until the installer resolves the unverified safety parameters.

## Fault/Alarm Handling

Each Sola Control reports to the OI display when a safety lockout or an Alert occurs.

Safety lockouts are indicated on each configuration page as an alarm bell symbol. At the home (for S7999C) or status page (for S7999B), the History button turns red. If the S7999B is displaying the system status icons, the control in alarm will turn red.

The lockout history can be displayed by pressing on the History button. The state information about each lockout is displayed along with the date/time that the lockout occurred (see Table 3). Current date/time stamp is a display setup feature.

**NOTE:** In the event of a power interruption, the date/time must be reset. The OI Display does NOT have a backup means.

**Table 3. Sola Control Lockout History.**

Data	Comment
Lockout time	Set by display
Fault code	Unique code defining which lockout occurred.
Annunciator first out	First interlock in limit string results in a shutdown.
Description	Fault description
Burner Lockout/Hold	Source/reason for lockout/hold
Burner control state	
Sequence time	Burner control state timer at time of fault
Cycle	Burner control cycle
Run Hours	Burner control hours
I/O	All digital I/O status at time of fault
Annunciator 1-8 states	All annunciator I/O status at time of fault
Fault data	Fault dependent data

An alert log can be displayed for each control by pressing the Alert button on the bottom of the history status page. A description of the alert is displayed along with the time when the alert occurred (see Table 4).

**Table 4. Sola Control Alert Log.**

Data	Comment
Alert time	Set by display
Alert code	Unique code defining which fault occurred.
Description	Alert description

## History Button

The History button on the Home page serves not only as a button, but also displays Sola Control lockouts, holds, and alerts as they occur. The History button can be selected at any time, regardless of which type of information is displayed, to view history information. Pressing the History button displays a dialog box (see Fig. 24) that allows the user to select the type



of history to view. The user can also silence an audible alarm generated by the control during a lockout or alert by alarm condition.

This History dialog box provides an exploded view of the status information displayed in the History button (the font is larger). One of the four buttons (OK, Lockouts, Alerts, or Silence) can be selected. If none of these buttons are selected the dialog box closes after 30 seconds.

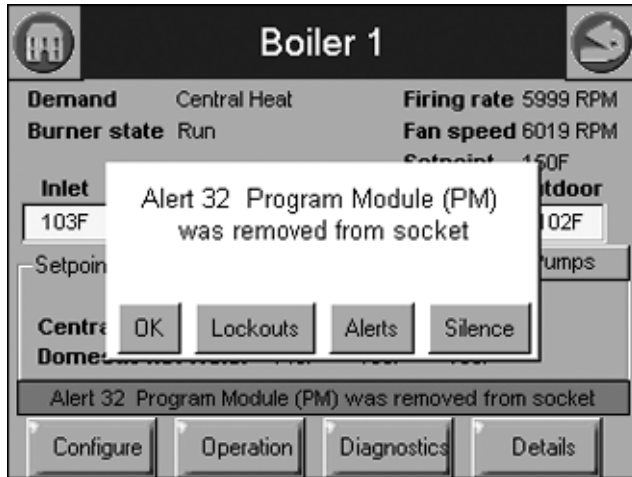

Fig. 24. Hydronic history example shown—exploded view.

Two types of historical data can be displayed on the history page: lockout history and alert log.

The entire 15 fault code history is displayed in a scrollable list with the most recent fault displayed first followed by the next most recent fault. Summary information is displayed for each fault entry, including the burner cycle count, fault code, and fault number with description. Detailed information for a specific fault entry that also includes burner control sequence state, burner run-time hours, annunciation status, etc., is viewed by selecting (touching the History line) the lockout entry in the list (see “Fault/Alarm Handling” on page 16 for details).

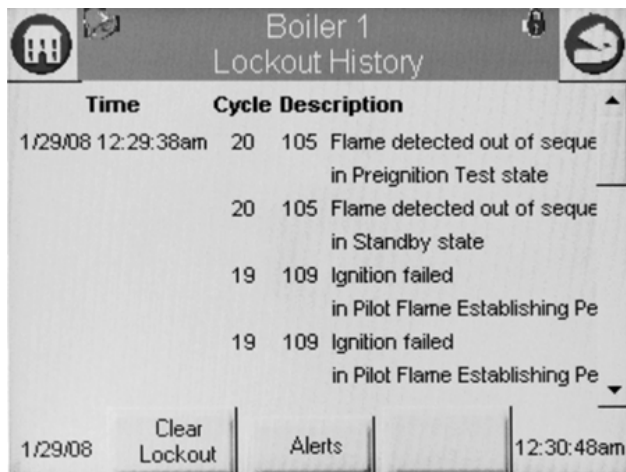

Fig. 25. Lockout history example shown.

The date and time that each fault occurred is displayed in the lockout history. The lockout timestamp displays in both the lockout summary and detail information.

The Sola Control does not maintain date or time of day information. The date and time stamp is assigned by the OI display. When the OI display first obtains the lockout and alert history from the control (during the display data synchronization), no timestamps are assigned since the times that the lockouts occurred are unknown. All new lockouts that occur after the synchronization are assigned timestamps.

NOTE: The system time can be set in the OI display to ensure that correct timestamps are given to the controls’ lockouts and alerts. Power interruptions will require the time to be reset as the display DOES NOT have a time backup means.

The Clear Lockout button allows the user to acknowledge and clear (reset) the lockout when in lockout state, much the same as pressing the reset button on the front of the Sola Control.

The user can toggle between displaying the controls’ lockout history and alert log by pressing the Alerts or Lockouts button on the bottom of the pages.

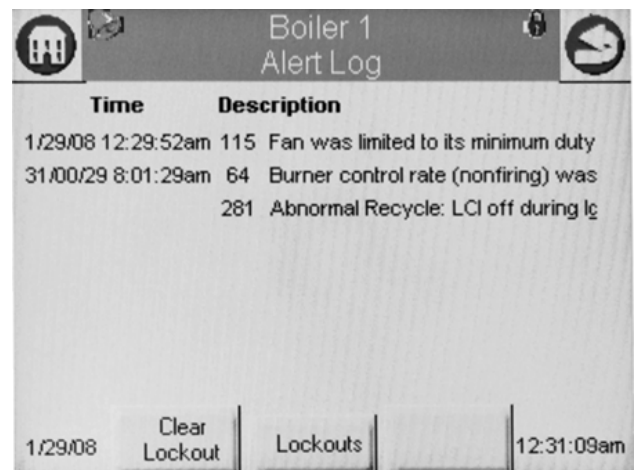

Fig. 26. Alert log example shown.

To see additional detail about a lockout or alert, touching on the lockout or alert in the list expands the view of that lockout or alert, as shown in Fig. 27 and 28.

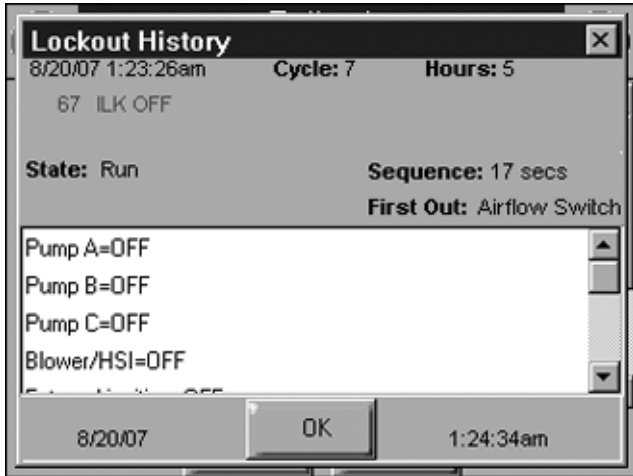

Fig. 27. Control expanded lockout detail.

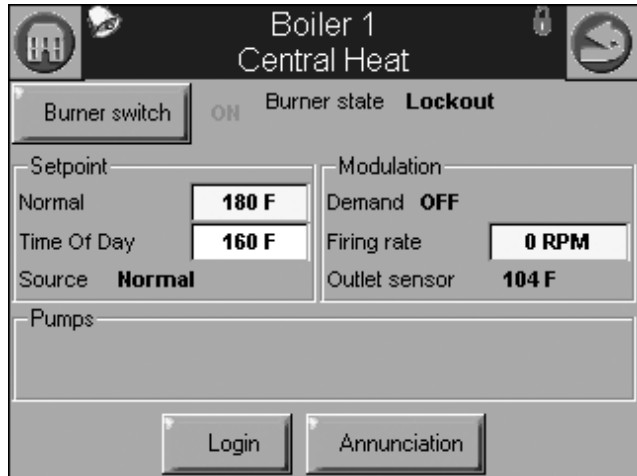

Fig. 29. Hydronic operation page shown.

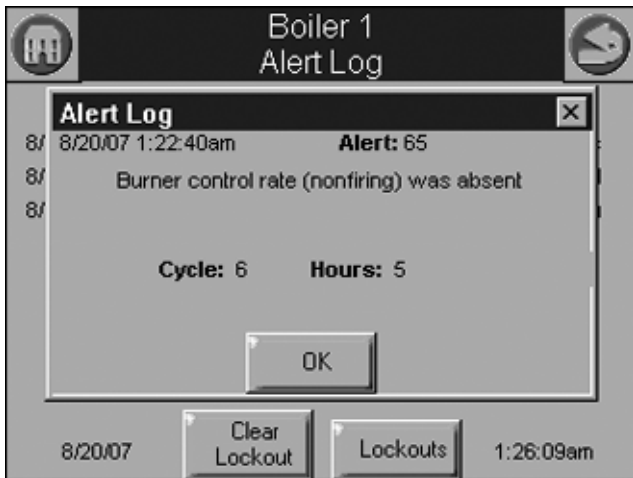

Fig. 28. Control expanded alert detail.

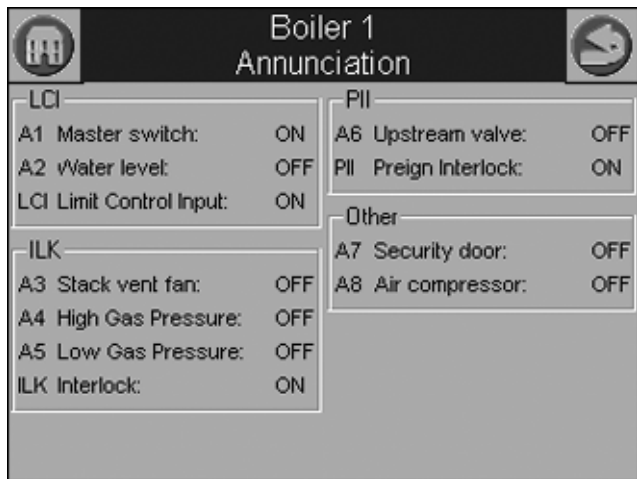

Fig. 30. Programmable annunciation.

## Operation Button

The operation button displays the SOLA Control running operation, including setpoint and firing rate values. From this page the user can change setpoints, manually control the boiler's firing rate, manually turn pumps on, view annunciation information, and switch between hydronic heating loops (Central Heat and Domestic Hot Water), as shown in Fig. 22. If a password is required to change any of the settings on this page, the user can press the Login button to enter the password.

Annunciation information is shown in Fig. 23 and Fig 24.

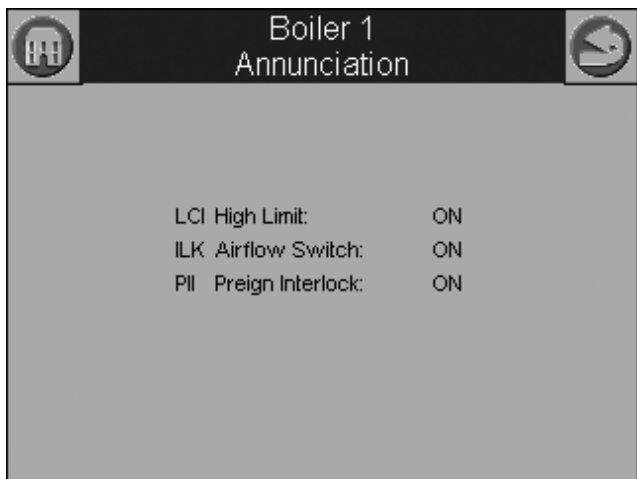

Fig. 31. Fixed annunciation.

## Diagnostics Button

The Diagnostics button displays analog and digital I/O status of the SOLA Control. A snapshot of the diagnostic status is displayed and updated once per second as it changes in the control. See "R7910A or R7911 Diagnostics" on page 44 for more information about this status.

The digital I/O data is displayed as LEDs that are either on (green) or off (red) (See Fig. 23). Not all digital I/O can be displayed at the same time on the page, so a horizontal scroll bar is used to move the view left and right to show all digital I/O data.

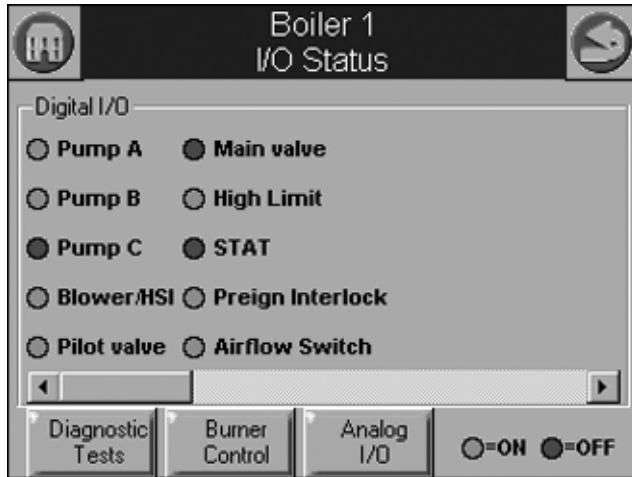

Fig. 32. Diagnostic page (digital I/O).

The control analog I/O can also be viewed on the OI Display. A snapshot of the diagnostic status is displayed and updated as it changes in the control.

The analog I/O data is displayed as bar charts with I/O level represented in the I/O range (see Figure 24.) Analog I/O that is not enabled for the installation displays a blank I/O level. Not all analog I/O can be displayed at the same time on the page, so a horizontal scroll bar is used to move the view left and right to show all analog I/O status.

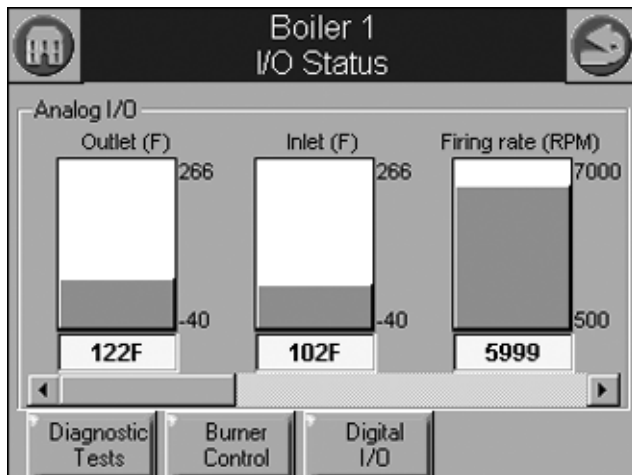

Fig. 33. Diagnostics page (analog I/O).

## System Configuration (S7999B OI Display Only)

The OI Display has some functions related to general configuration for the control in the end user installation.

Pressing the Display Refresh button invokes a search procedure (see Fig. 34). A new R7910A Hydronic Control or R7911 Steam Control is identified by "Unknown" status next to its name in the boiler system list (see Fig. 35). "Unknown" indicates that configuration data has not been retrieved from the control yet.

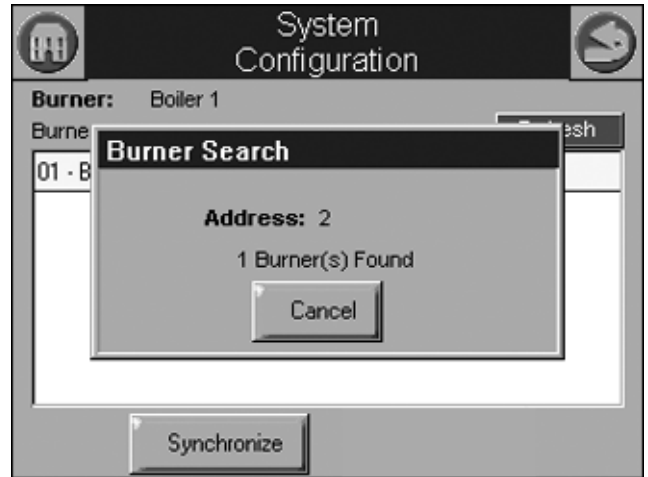

Fig. 34. System refresh.

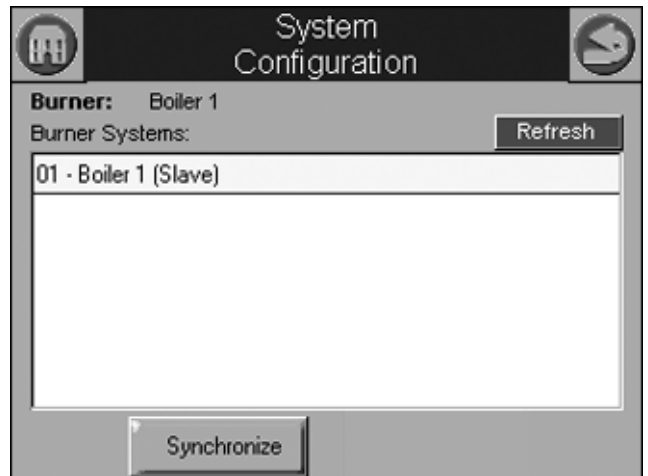

Fig. 35. System configuration page.

The control connected to the Modbus network is indicated to the user after the search procedure has concluded.

Once the control is located it must be synchronized with the OI Display before it can be displayed. New controls are not displayed on the Home page until this synchronization (see below) is performed.

## System Synchronization (S7999B OI Display Only)

The user can manually synchronize configuration data from the connected controls at any time.

A new control is visible when configuration and status data is gathered from it. This collection procedure takes a few minutes. The control is marked as “Unknown” when no configuration information exists. Normally, control configuration data collection only needs to be performed when the control is initially installed. However, a re synchronization is necessary after the OI Display is reset. See Fig. 36.

The user presses the Synchronize button to begin synchronization with the control. See Fig. 36.

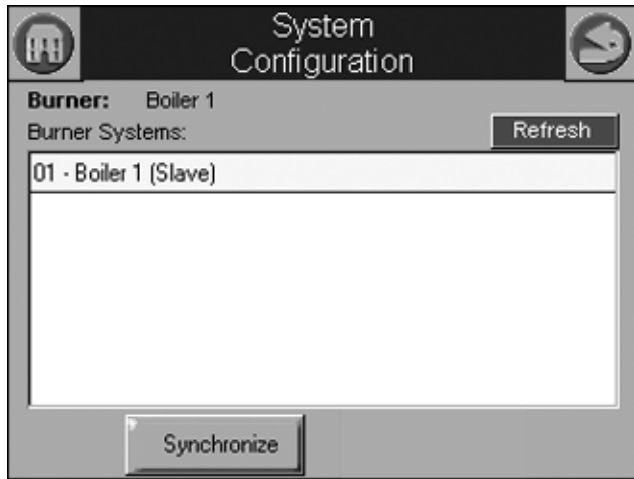

Fig. 36. System synchronization.

Status of the synchronization is reflected in the dialog box. The synchronization can be aborted by selecting the Cancel button.

## Configuration

The SOLA Control can be configured from the OI Display. The control configuration is grouped into the functional groups seen in Table 5.

Table 5. Functional Configuration Groups.

Hydronic Control	Steam Control
System Identification and Access	Steam Identification and Access
CH - Central Heat	Steam Configuration
Outdoor Reset	Modulation Configuration
DHW - Domestic Hot Water	Pump Configuration
DHW Storage	
DHW Plate	
Warm Weather Shutdown	
Demand Priority	
Modulation Configuration	Statistics Configuration
Pump Configuration	Stack Limit
Statistics Configuration	Annunciation Configuration
High Limit	Burner Control Interlocks
Stack Limit	Burner control Timings and Rates
Delta T Limits	

Table 5. Functional Configuration Groups.

Hydronic Control	Steam Control
T-Rise Limit	
Heat Exchanger High Limit	
Anti-condensation	Burner Control Flame Failure
Frost Protection Configuration	System Configuration
Annunciation Configuration	Fan Configuration
Burner Control Interlocks	Lead Lag Configuration
Burner Control Timings and Rates	
Burner Control Ignition	
Burner Control Flame Failure	
System Configuration	
Fan Configuration	
Sensor Configuration	
Lead Lag Slave Configuration	
Lead Lag Master Configuration	

Most of this configuration is performed by either the contractor/installer or at Honeywell. Each functional group is displayed on the Configuration menu page.

Parameters in functional groups that are not applicable for the installation can be ignored. In some cases, features in a functional group are disabled by default and are enabled when needed for the installation.

## R7910A HYDRONIC CONTROL, R7911 STEAM CONTROL CONFIGURATION PARAMETERS

The following pages list the configuration parameters available for the R7910A or R7911 installed.

NOTE: Individual Configuration pages may differ from this text as features are added or amended by Honeywell.

A password is required to make changes to the Configuration Parameters. The SOLA Control will be in a Lockout 2 “waiting for safety data verification” as received or will go to a Lockout 2 when changes are made to the safety data.

### WARNING

**Explosion Hazard.**  
**Improper configuration can cause fuel buildup and explosion.**  
 Improper user operation may result in PROPERTY LOSS, PHYSICAL INJURY or DEATH.

The OI Display used to change parameters, must be attempted by **only experienced and/or licensed burner/boiler operators and mechanics.**

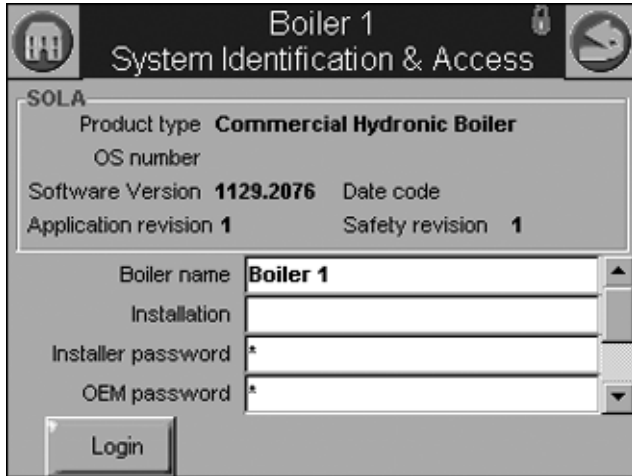

**Fig. 37. System identification and access configuration. (Hydronic Screen Shown.)**

Table 6 displays System Identification and Access parameters.

**Table 6. System Identification and Access Parameters.**

Parameter	Comment
Boiler Name	Name to identify boiler (up to 20 characters)
Installation	Notes regarding installation (up to 20 characters)
Installer password	Change installer password setting
OEM password	Change OEM password setting
Factory Data	OEM name to associate with boiler (up to 20 characters)

When the burner name is changed, the name is saved in the R7910A or R7911 and displayed in the title of all pages that zoom into the control.

Default parameter settings for installer and Honeywell passwords are "sola" and "solaoem," respectively. These passwords most likely have been changed by Honeywell.

Factory Data gives Honeywell an option to display a brand name other than Sola on this configuration page. Additional information displayed on this page is listed in Table 7.

**Table 7. System Identification Information.**

Status	Comment
Product Type	Type of product that the burner is
OS Number	Model number associated with burner
Software Version	Version of software running in the R7910A or R7911
Date Code	Date when R7910A or R7911 was assembled
Application Revision	Version of application data in the R7910A or R7911
Safety Revision	Revision of safety data in the R7910A or R7911

## Central Heat Parameters (R7910A Hydronic Control Only)

Table 8 displays Central Heat Hydronic Control configuration parameters.

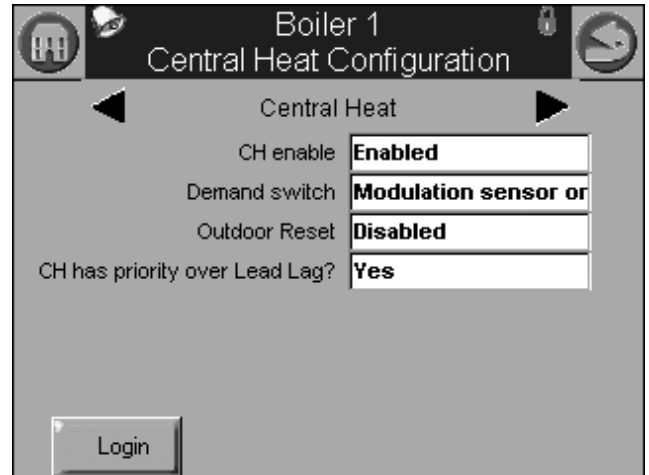

**Fig. 38. Central Heat hydronic configuration.**

**Table 8. Central Heat Hydronic Configuration Parameters.**

Parameter	Comment
CH enable	Disable or Enable Central Heating Loop
Demand switch	Sensor for Central Heat demand: Sensor only Sensor & STAT terminal Sensor & Remote Stat LCI & Sensor
Outdoor reset	Enabled Disabled
CH has priority over Lead Lag	Yes, No, Cancel
Setpoint source	Local S2 (J8-6) 4-20mA
Setpoint	Setpoint for normal Central Heat modulation: -40 °F to 266 °F (-40 °C to 130 °C)
Time of day setpoint	Setpoint when Time Of Day switch is on. -40 °F to 266 °F (-40 °C to 130 °C)
Off hysteresis	Differential above setpoint when boiler is turned off. 32 °F to 266 °F (0 °C to 130 °C)
On hysteresis	Differential from setpoint when boiler is turned on. 32 °F to 266 °F (0 °C to 130 °C)
4 mA water temperature	-40 °F to 266 °F (-40 °C to 130 °C)
20 mA water temperature	-40 °F to 266 °F (-40 °C to 130 °C)
Modulation sensor	Outlet sensor, Inlet sensor, S5 (J8-11)

**Table 8. Central Heat Hydronic Configuration Parameters. (Continued)**

Parameter	Comment
Modulation Rate Sensor	Local
P-gain	Gain applied for the P portion of the PID equation 0-400
I-gain	Gain applied for the I portion of the PID equation 0-400
D-gain	Gain applied for the D portion of the PID equation 0-400
Hysteresis step time	Time between hysteresis step changes: 0-600 seconds (0=Disable hysteresis stepping)

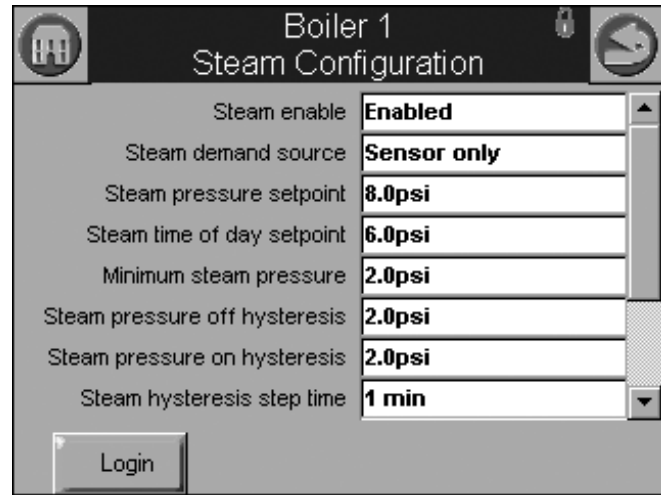

**Fig. 39. R7911 Steam Configuration.**

**Table 9. Steam Configuration Parameters**

Parameter	Comment
Steam enable	Disable/enable steam feature
Steam demand source	Sensor and LCI Sensor and Remote Stat Sensor and Stat Terminal Sensor Only
Steam pressure setpoint	Setpoint for normal modulation Adjustable 0 to 15 or 0 to 150 (sensor dependant)
Steam time of day setpoint	Setpoint when TOD switch on Adjustable 0 to 15 or 0 to 150 (sensor dependant)
Minimum steam pressure	Establishes setpoint for the 4ma. input. Adjustable 0 to 15 or 0 to 150 (sensor dependant)
Steam pressure off hysteresis	Differential below setpoint when boiler is turned off Adjustable 0 to 15 or 0 to 150 (sensor dependant)

**Table 9. Steam Configuration Parameters**

Parameter	Comment
Steam pressure on hysteresis	Differential from setpoint when boiler is turned on. Adjustable 0 to 15 or 0 to 150 (sensor dependant)
Steam hysteresis step time	Time between hysteresis changes 0 to 600 seconds (0=disable)
Steam P Gain	Gain applied for the P portion of the PID equation 0-400
Steam I Gain	Gain applied for the I portion of the PID Equation - 0-400
Steam D Gain	Gain applied for the D portion of the PID equation 0-400
Steam 4-20 ma remote control	uses 4-20ma remote control function to control either the setpoint or modulation for Steam Disable, setpoint, modulation

### Outdoor Reset Parameters (R7910A Hydronic Control Only)

Table 10 displays Outdoor Reset configuration parameters. Pressing the left or right arrow displays Lead Lag, which lists the same parameters.

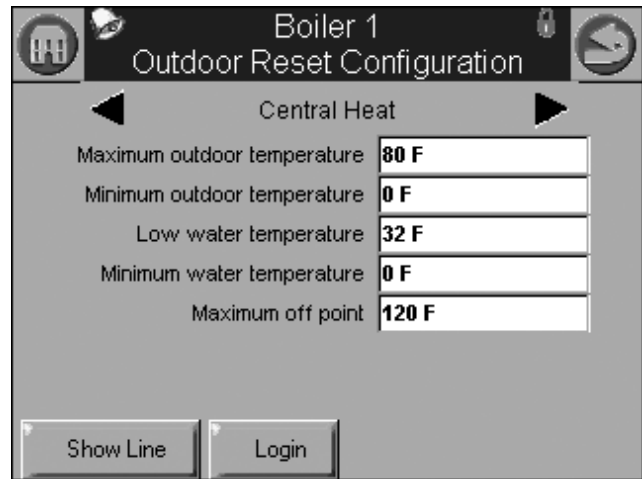

**Fig. 40. Outdoor reset configuration.**

**Table 10. Outdoor Reset Configuration Parameters.**

Parameter	Comment
Maximum outdoor temperature	-40 °F to 266 °F (-40 °C to 130 °C)
Minimum outdoor temperature	-40 °F to 266 °F (-40 °C to 130 °C)
Low water temperature	-40 °F to 266 °F (-40 °C to 130 °C)
Minimum water temperature	-40 °F to 266 °F (-40 °C to 130 °C)
Maximum off point	-40 °F to 266 °F (-40 °C to 130 °C)

## Domestic Hot Water (DHW) Configuration Parameters (R7910A Hydronic Control Only)

Table 11 displays Domestic Hot Water (DHW) configuration parameters.

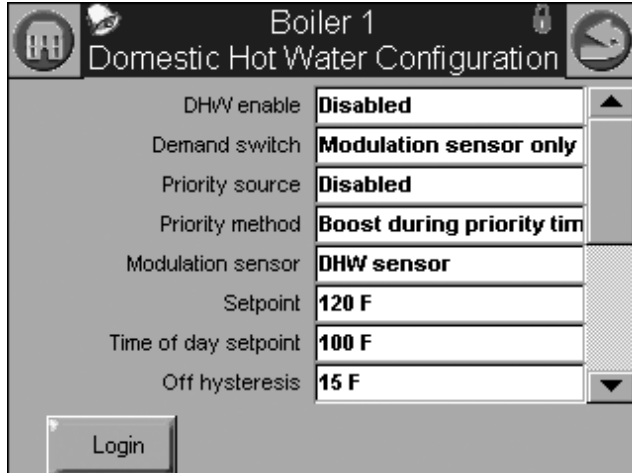

Fig. 41. Domestic Hot Water (DHW) configuration.

Table 11. Domestic Hot Water (DHW) Configuration Parameters.

Parameter	Comment
Enable	Disable or Enable Domestic Hot Water Loop
Demand switch	Sensor for Central Heat demand: DHW sensor only, DHW sensor & Remote Stat, DHW switch & inlet sensor, or DHW switch & outlet sensor
Priority source	Which system has priority: Disabled or Heat Demand
Priority method	Boost during priority time Drop after priority time
Modulation sensor	DHW Sensor Outlet Sensor Inlet Sensor Auto: DHW (S6) or Inlet Sensor Auto: DHW (S6) or Outlet Sensor
Setpoint	-40 °F to 240 °F (-40 °C to 115 °C)
Time of day setpoint	Setpoint when Time Of Day switch is on. -40 °F to 240 °F (-40 °C to 115 °C)
Off hysteresis	Differential above setpoint when boiler is turned off. -40 °F to 240 °F (-40 °C to 115 °C)
On hysteresis	Differential from setpoint when boiler is turned on. 2 °F to 234 °F (-16 °C to 112 °C)
DHW priority override time	___hour ___min ___sec

Table 11. Domestic Hot Water (DHW) Configuration Parameters. (Continued)

Parameter	Comment
Hysteresis step time	___hour ___min ___sec
DHW priority vs CH	Which system has priority: Central Heat over Domestic Hot Water, or Domestic Hot Water over Central Heat
DHW priority vs Lead Lag	Which system has priority: Lead Lag over Domestic Hot Water, Domestic Hot Water over Lead Lag
DHW P-gain	Gain applied for the P portion of the PID equation 0-400
DHW I-gain	Gain applied for the I portion of the PID equation 0-400
DHW D-gain	Gain applied for the D portion of the PID equation 0-400

## DHW Storage Configuration

Table 12 displays DHW Storage configuration parameters.

Table 12. DHW Storage Configuration Parameters.

Parameter	Comment
DHW storage enable	Enabled, Disabled
Storage time	___hour ___min ___sec
Setpoint	-40 °F to 266 °F (-40 °C to 130 °C)
Off hysteresis	-0 °F to 180 °F (-17 °C to 82 °C)
On hysteresis	-0 °F to 180 °F (-17 °C to 82 °C)

## DHW Plate Heat Exchanger Configuration

Table 13 displays DHW Plate Heat Exchanger configuration parameters.

Table 13. DHW Plate Heat Exchanger Configuration Parameters.

Parameter	Comment
Tap detect degrees	-0 °F to 180 °F (-17 °C to 82 °C)
Tap detect on recognition time	___hour ___min ___sec
Tap detect on threshold	-0 °F to 180 °F (-17 °C to 82 °C)
Tap detect minimum on time	___hour ___min ___sec
Tap stop inlet-DHW degrees	-0 °F to 180 °F (-17 °C to 82 °C)
Tap stop outlet-Inlet degrees	-0 °F to 180 °F (-17 °C to 82 °C)

**Table 13. DHW Plate Heat Exchanger Configuration Parameters. (Continued)**

Parameter	Comment
Plate preheat setpoint	-40 °F to 266 °F (-40 °C to 130 °C)
Plate preheat on recognition time	___hour ___min ___sec
Plate preheat on hysteresis	-0 °F to 180 °F (-17 °C to 82 °C)
Plate preheat off hysteresis	-0 °F to 180 °F (-17 °C to 82 °C)
Plate preheat detect on threshold	-0 °F to 180 °F (-17 °C to 82 °C)
Plate preheat detect off threshold	-0 °F to 180 °F (-17 °C to 82 °C)
Plate preheat minimum on time	___hour ___min ___sec
Plate preheat delay after tap	___hour ___min ___sec

### Warm Weather Shutdown Configuration

Table 14 displays Warm Weather Setpoint configuration parameters.

**Table 14. Warm Weather Setpoint Configuration Parameters.**

Parameter	Comment
Enable	Enabled, disabled
Setpoint	-40 °F to 266 °F (-40 °C to 130 °C)

### Demand Priority Configuration Parameters

Fig. 42 displays R7910A Hydronic Control Demand Priority configuration options. Press the arrows to change the priority order.

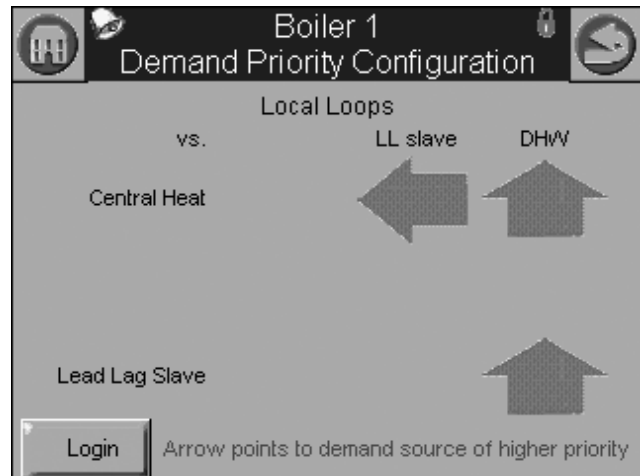

**Fig. 42. Demand priority configuration.**



## Modulation Configuration Parameters

Table 15 displays R7910A Hydronic Control Modulation configuration parameters.

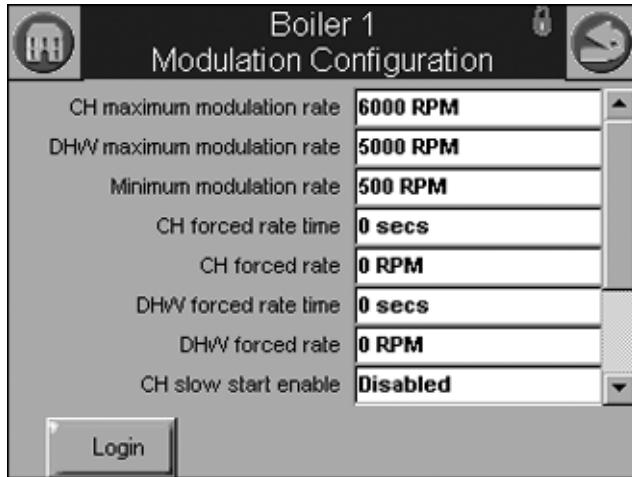

Fig. 43. Modulation configuration.

## Steam Modulation Configuration Parameters

Table 16 displays R7911 Steam Modulation Configuration parameters.

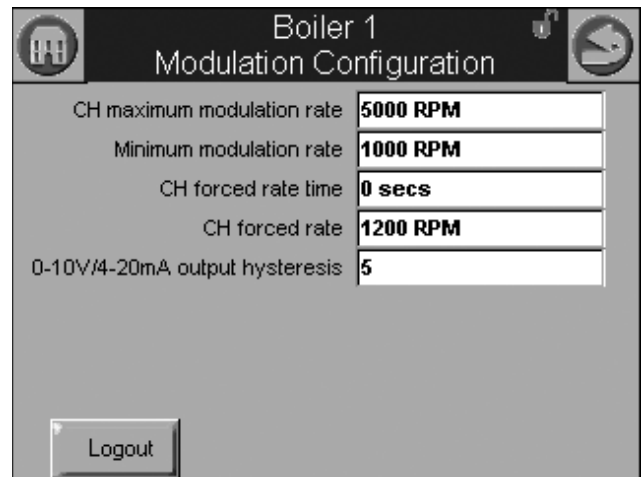

Fig. 44. Steam modulation configuration.

Table 15. R7910A Hydronic Control Modulation Configuration Parameters.

Parameter	Comment
CH maximum modulation rate	RPM or %
DHW maximum modulation rate	RPM or %
Minimum modulation rate	RPM or %
CH forced rate time	0-600 seconds
CH forced rate	RPM or %
DHW forced rate time	0-600 seconds
DHW forced rate	RPM or %
CH slow start enable	Enabled Disabled
DHW slow start enable	Enabled Disabled
Slow start degrees	-40 °F to 266 °F (-40 °C to 130 °C)
Slow start ramp	RPM /minute or %/minute
0-10/4-20 mA Output hysteresis	

Table 16. R7911 Steam Modulation Configuration Parameters.

Parameter	Comment
CH maximum modulation rate	RPM or %
Minimum modulation rate	RPM or %
CH forced rate time	0-600 seconds
CH forced rate	RPM or %
0-10/4-20 mA Output hysteresis	

## Pump Configuration Parameters

Table 17 displays Pump configuration parameters. Use the left and right arrows to switch between Central Heat, Boiler, DHW, System, Auxiliary 1, and Auxiliary 2 pumps. The parameters are the same for all pumps.

Pressing the Advanced Settings button brings up a number of other advanced configuration options for each pump. Press the Control Settings button to return to the screen shown in Fig. 45.

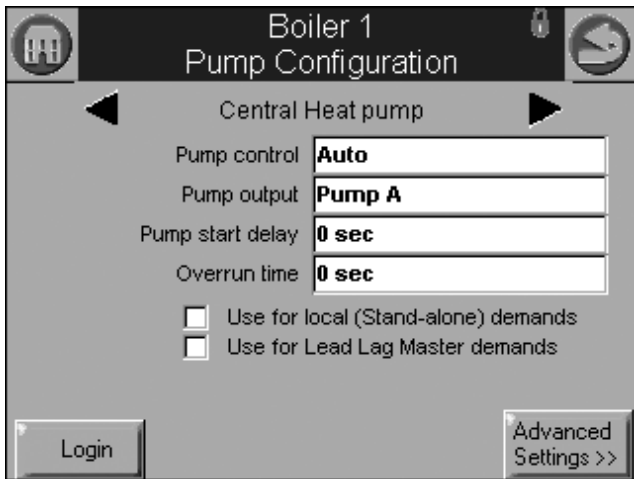

Fig. 45. Pump configuration.

Table 17. Pump Configuration Parameters for R7910A Hydronic System.

Parameter	Comment
Pump control	Auto On
Pump output	Pump A Pump B Pump C None
Pump start delay	__hour __min __sec
Overrun time	__hour __min __sec

\*Table 61 on page 53 has more parameters listed.

NOTE: The R7911 Steam Control does not have pumps, but the outputs are available to operate air dampers or accessories. CH Pump, Boiler Pump and System Pump are used for these output options.

Table 17a. Pump Configuration Parameters for R7911 Steam Modulation Configuration Parameters.

Parameter	Comment
Auxiliary pump control	Auto On
Auxiliary pump is on when	CH pump is ON Slave command
Auxiliary pump output	Pump A Pump B Pump C None
Boiler pump control	Auto On
Boiler pump output	Pump A Pump B Pump C None
Boiler pump overrun time	0-600 seconds 0 = Not configured
CH pump control	Auto On
CH pump output	Pump A Pump B Pump C None
CH pump overrun time	0-600 seconds 0 = Not configured
System pump control	Auto On
System pump output	Pump A Pump B Pump C None
System pump ourrun time	0-600 seconds 0 = Not configured
Pump exercise time	0-600 seconds 0= Not configured

## Statistics Configuration Parameters

Table 15 displays Statistics configuration parameters.

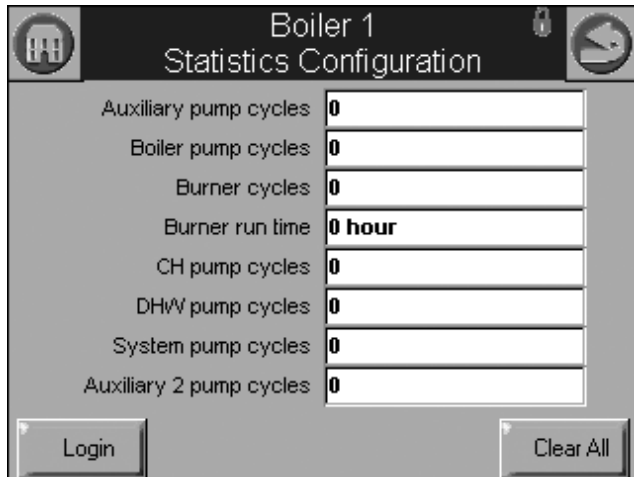

Fig. 46. Statistics configuration.

Table 18. Statistics Configuration Parameters.

Parameter	Comment
Auxiliary pump cycles	0-999,999
Boiler pump cycles	0-999,999
Burner cycles	0-999,999
Burner run time	0-999,999
CH pump cycles	0-999,999
DHW pump cycles	0-999,999
System pump cycles	0-999,999
Auxiliary 2 pump cycles	0-999,999

## High Limit Configuration Parameters (R7910A Hydronic Control Only)

Table 19 displays outlet high limit configuration parameters.

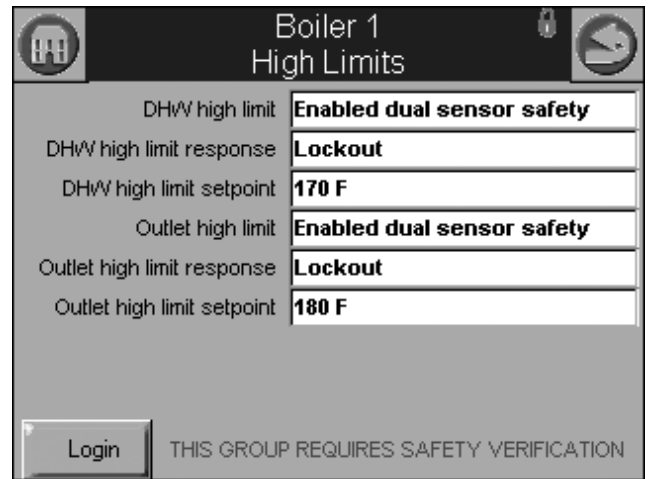

Fig. 47. High Limits configuration.

Table 19. High Limit Configuration Parameters.

Parameter	Comment
DHW high limit	Enabled Disabled
DHW high limit response	Recycle & hold Lockout
DWH high limit setpoint	-40 °F to 266 °F (-40 °C to 130 °C)
Outlet high limit	Enabled Disabled
Outlet high limit response	Recycle & hold Lockout
Outlet high limit setpoint	-40 °F to 266 °F (-40 °C to 130 °C)

## Stack Limit Configuration Parameters

Table 20 displays stack limit configuration parameters.

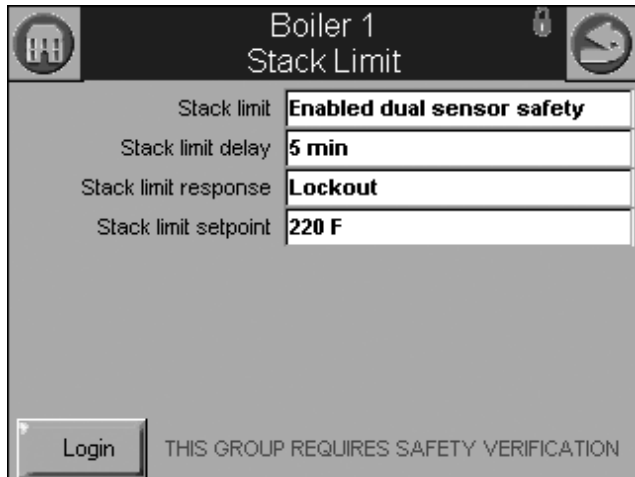

Fig. 48. Stack Limit configuration.

Table 20. Stack Limit Configuration Parameters.

Parameter	Comment
Stack limit	Enabled dual sensor safety Enabled single sensor non safety Disabled
Stack limit delay	___hour ___min ___sec
Stack limit response	Lockout Recycle & delay
Stack limit setpoint	32 °F to 266 °F (0 °C to 130 °C)

## Delta T Limit Configuration Parameters

### (R7910A Hydronic Control Only)

Table 21 displays other limit parameters. Use the left and right arrows to switch between Inlet to Outlet Flow and Exchanger to Outlet Flow. The parameters are the same for all pumps.

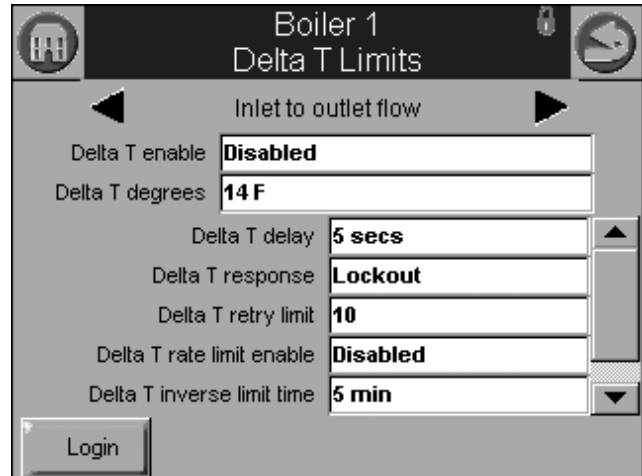

Fig. 49. Delta T Limit configuration.

Table 21. Delta T Limit Configuration Parameters.

Parameter	Comment
Delta T enable	Enabled Disabled
Delta T degrees	0 °F to 234 °F (-17 °C to 112 °C)
Delta T delay	___hour ___min ___sec
Delta T response	Recycle & delay Recycle & Delay with retry limit Lockout
Delta T retry limit	0–100
Delta T rate limit enable	Enabled Disabled
Delta T inverse limit time	___hour ___min ___sec
Delta T inverse limit response	Recycle & delay Recycle & delay with retry limit Lockout

## T-Rise Limit Configuration Parameters

Table 22 displays T-Rise limit parameters.

**Table 22. T-Rise Limit Configuration Parameters.**

Parameter	Comment
Outlet T-rise enable	Enabled Disabled
Heat exchanger T-rise enable	Enabled Disabled
T-rise degrees	0 °F to 234 °F (-17 °C to 112 °C)/sec
T-rise response	Recycle & delay Recycle & delay with retry limit Lockout
T-rise retry limit	0 to 100
T-rise delay	__hour __min __sec

## Heat Exchanger High Limit Configuration Parameters

Table 23 displays T-Rise limit parameters.

**Table 23. Heat Exchanger High Limit Configuration Parameters.**

Parameter	Comment
Heat exchanger high limit enable	Enabled Disabled
Heat exchanger high limit setpoint	-40 °F to 266 °F (-40 °C to 130 °C)
Heat exchanger high limit response	Recycle & delay Recycle & delay with retry limit Lockout
Heat exchanger retry limit	0 to 100
Heat exchanger high limit delay	__hour __min __sec

## Anti-Condensation Configuration Parameters (R7910A Hydronic Control Only)

Table 24 displays anti-condensation parameters. Use the left and right arrows to switch between Central Heat, Domestic Hot Water, Frost Protection, and Priority parameters.

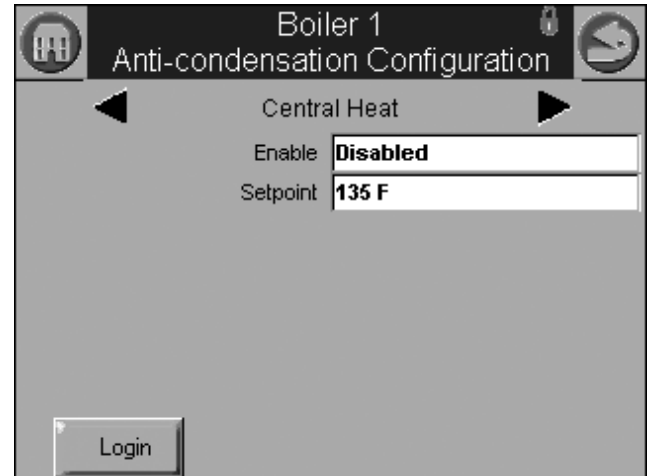

**Fig. 50. Anti-condensation configuration.**

**Table 24. Anti-Condensation Configuration Parameters.**

Parameter	Comment
CH Enable	Enabled Disabled
CH Setpoint	-40 °F to 266 °F (-40 °C to 130 °C)
DHW Enable	Enabled Disabled
DHW Setpoint	-40 °F to 266 °F (-40 °C to 130 °C)
Frost Protection Enable	Enabled Disabled
Anticondensation Priority	Anticondensation is more important than (check those that apply): Stack limit Delta T limit Slow start Forced rate Outlet high limit

## Frost Protection Parameters (R7910A Hydronic Control Only)

Table 25 displays frost protection parameters.

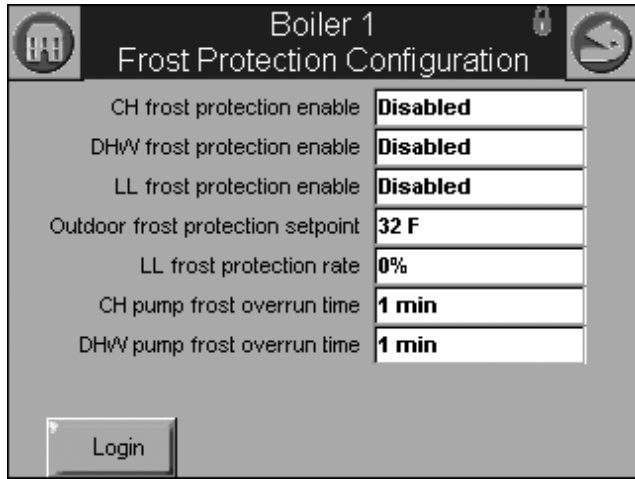

Fig. 51. Frost Protection configuration.

Table 25. Frost Protection Configuration Parameters.

Parameter	Comment
CH frost protection enable	Enabled Disabled
DHW frost protection enable	Enabled Disabled
Lead Lag frost protection enable	Enabled Disabled
Outdoor frost protection setpoint	-40 °F to 266 °F (-40 °C to 130 °C) (applicable for CH only)
Lead Lag frost protection rate	___%
CH pump frost overrun time	___hour ___min ___sec
DHW pump frost overrun time	___hour ___min ___sec

## Annunciation Configuration Parameters

Table 26 displays annunciation configuration parameters.

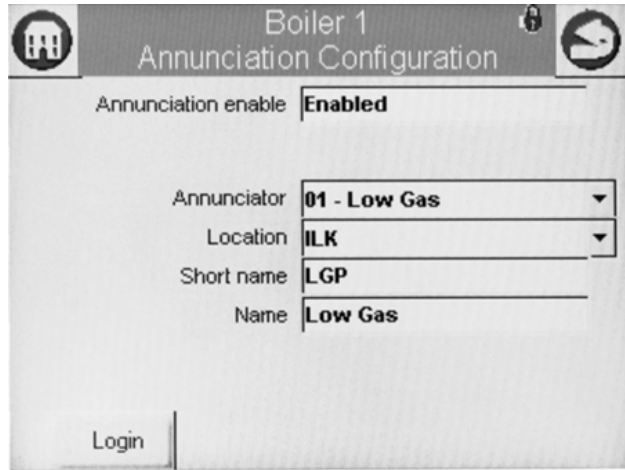

Fig. 52. Annunciation configuration example.

Table 26. Annunciation Configuration Parameters.

Parameter	Comment
Annunciation enable	Enabled Disabled
Annunciator (1–8) location	01 - Annunciator 1 02 - Annunciator 2 03 - Annunciator 3 04 - Annunciator 4 05 - Annunciator 5 06 - Annunciator 6 07 - Annunciator 7 08 - Annunciator 8 PII - Pre-Ignition ILK LCI - Load Control Input ILK - Interlock
Annunciator (1–8) short name	Up to 3 characters
Annunciator (1–8) name	Up to 20 characters

## Safety Configuration Parameters

Table 27 through 30 display safety parameters.

NOTE: Login is required to change Safety Parameters and the SOLA Control will go to a Lockout 2 “waiting for safety data verification” when a change is made.

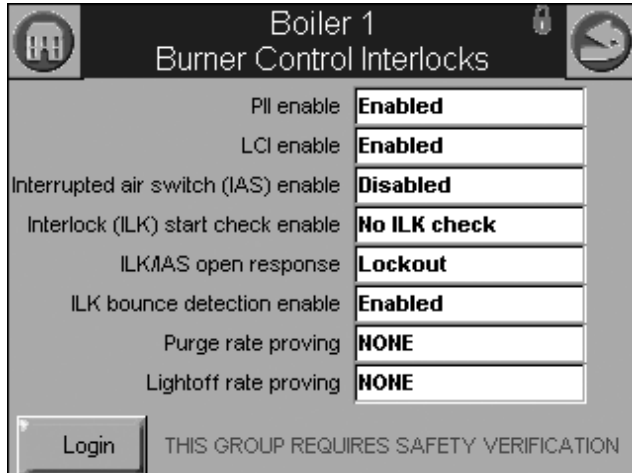

Fig. 53. Burner Control Interlocks control.

Table 27. Burner Control Interlocks Configuration.

Parameter	Comment
PII enable	Enabled Disabled
LCI enable	Enabled Disabled
Interrupted air switch (IAS) enable	Enable during purge and ignition Disabled Enable during purge
Interlock (ILK) start check enable	No ILK check ILK check
ILK/IAS open response	Recycle Lockout
ILK bounce detection enable	Enabled Disabled
Purge rate proving	Fan Speed High Fire Switch None
Lightoff rate proving	Fan Speed Low Fire Switch None

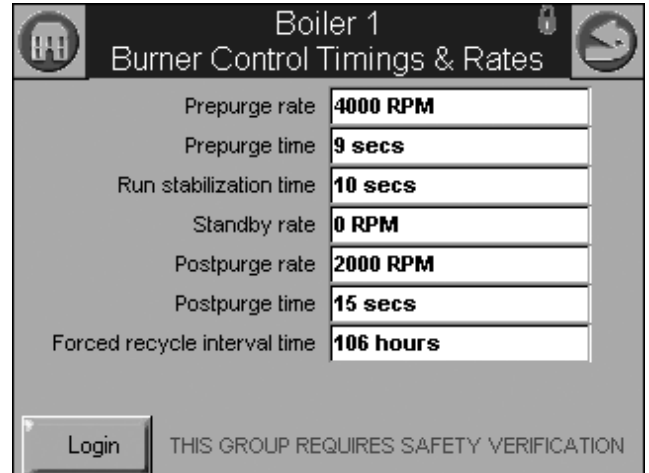

Fig. 54. Burner Control Timings and Rates configuration.

Table 28. Burner Control Timings and Rates Configuration.

Parameter	Comment
Prepurge rate	RPM or %
Prepurge time	__hour __min __sec
Run stabilization time	__hour __min __sec
Standby Rate	RPM or %
Postpurge rate	RPM or %
Postpurge time	__hour __min __sec
Forced recycle interval time	__day __hour __min

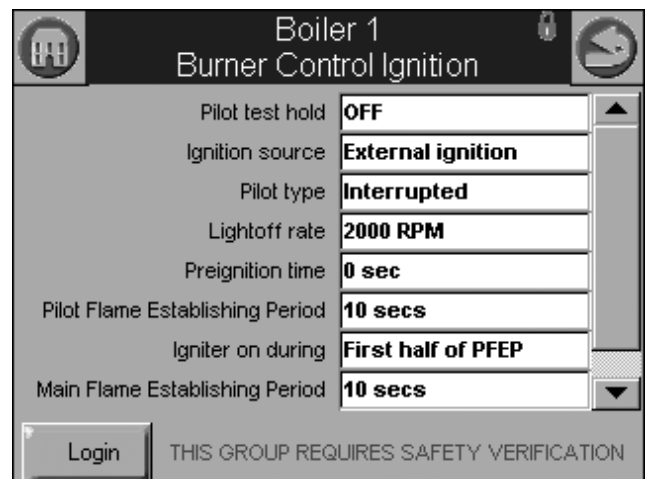
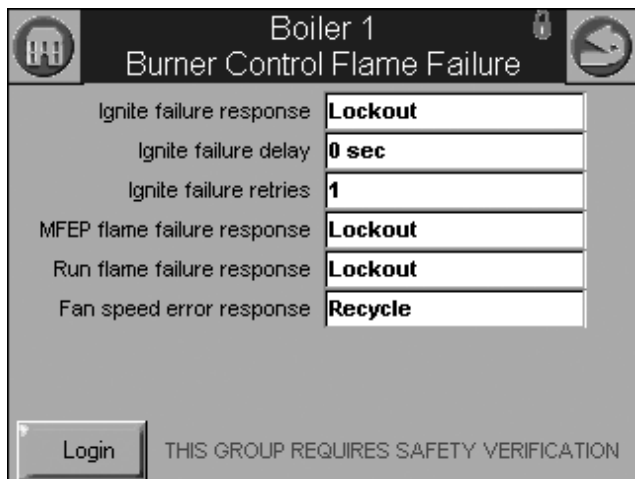

Fig. 55. Burner Control Ignition configuration.

**Table 29. Burner Control Ignition Configuration.**

Parameter	Comment
Pilot test hold	On Off
Ignition source	Hot Surface Igniter External ignition Internal ignition
Pilot type	Direct burner constant ignition Direct burner pulsed ignition Intermittent Interrupted
Lightoff rate	RPM or %
Preignition time	__hour __min __sec
Pilot Flame Establishing Period	15 secs 10 secs 4 secs
Igniter on during	1st half of PFEP Pilot Flame Establishing Period
Main Flame Establishing Period	15 secs 10 secs 5 secs
Flame Threshold	μA/V



**Fig. 56. Burner Control Flame Failure configuration.**

**Table 30. Burner Control Flame Failure Configuration.**

Parameter	Comment
Ignite failure response	Lockout Recycle Recycle & hold Recycle & lockout
Ignite failure delay	__hour __min __sec

**Table 30. Burner Control Flame Failure Configuration. (Continued)**

Ignite failure retries	1, 3, or 5
MFEP flame failure response	Recycle Lockout
Run flame failure response	Recycle Lockout
Fan speed error response	Recycle Lockout

### Safety Parameter Verification

When any of the safety configuration parameters are changed, the safety parameter verification procedure must be performed before the control will resume burner control. The control enters a lockout state, if not already in one, and remains locked out until this verification procedure is performed.

Safety parameter verification lockout occurs when safety parameter setting is changed. See Fig. 57.

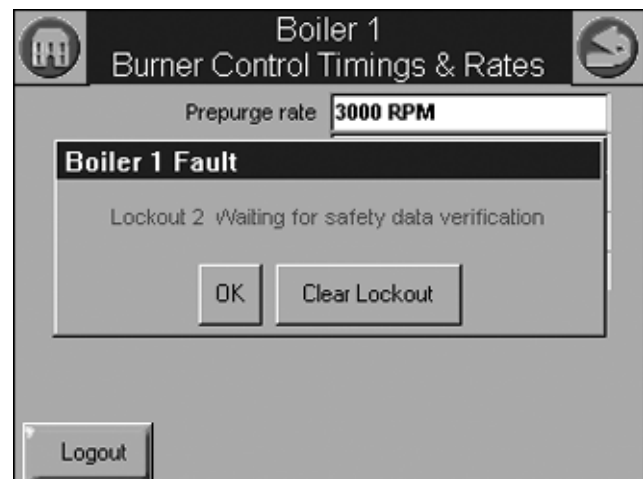

**Fig. 57. Safety verification lockout.**

The user must log in before verification can be completed, as shown in Fig. 58.



**Fig. 58. Safety verification login.**



After successful login, the user presses the Begin button to start safety parameter verification. See Fig. 59.



**Fig. 59. Begin safety verification.**

The first group of safety configuration parameters that needs verification is displayed. The user is asked to confirm that the settings are correct, as shown in Fig. 60.

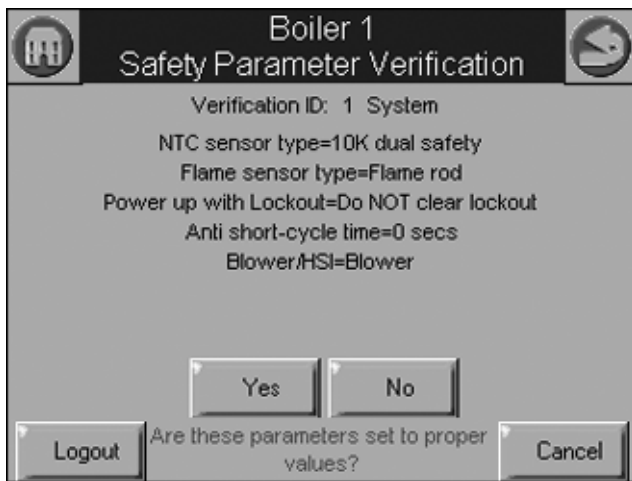

**Fig. 60. Confirm safety parameter settings.**

After the first safety parameter group has been confirmed by the user (by pressing the Yes button), the next safety parameter group waits for verification as shown in Fig. 61.



**Fig. 61. Safety parameter settings confirmed; next group waiting for confirmation.**

The user has 30 secs to confirm each safety configuration group's settings. If the user takes too long to confirm the settings, an error message is displayed, as shown in Fig. 62.

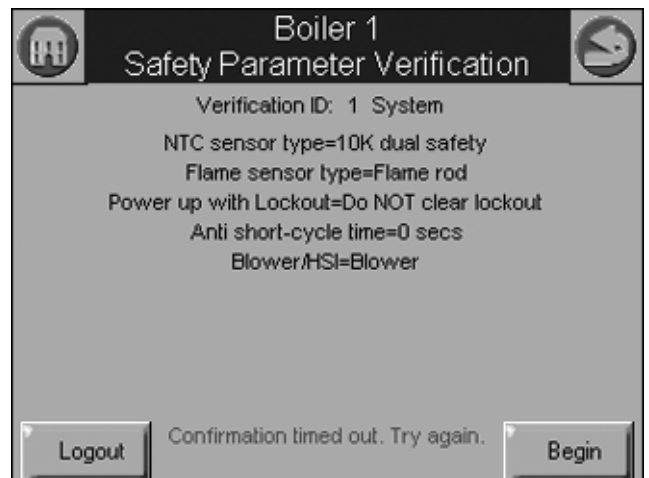

**Fig. 62. Confirmation timed out.**

After all safety parameter groups have been verified, the user must press the Reset button on the control within 30 seconds to confirm the correct device. See Fig. 63.



**Fig. 63. Reset R7910A or R7911.**

When the user has pressed the Reset button on the control, completing verification procedure, a Verification Complete screen is displayed, as shown in as shown in Fig. 64.



**Fig. 64. Safety parameter configuration complete.**

If for some reason the user does not press the Reset button on the control within 30 seconds, the configuration is cancelled, as shown in Fig. 65.



**Fig. 65. Control reset timed out.**

## Individual R7910A or R7911 Configuration Parameters

Table 31 and Table 32 displays system configuration parameters for individual controls.

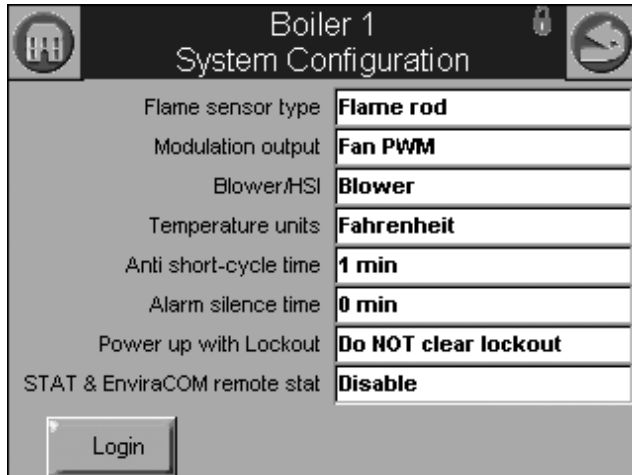

Fig. 66. System configuration (R7911 shown).

Table 31. R7910A Hydronic System Configuration Parameters.

Parameter	Comment
Flame sensor type	Flame rod UV power tube UV power tube with spark interference None
Modulation output	4-20mA 0-10V Fan PWM
Blower/HSI	Blower Hot surface ignition
Temperature units	Fahrenheit Celsius
Anti short-cycle time	___ hour ___ min ___ sec
Alarm silence time	___ hour ___ min ___ sec
Power up with Lockout	Clear lockout Do NOT clear lockout
STAT & EnviraCOM remote stat	Enabled Disabled

Table 32. R7911 System Configuration Parameters.

Parameter	Comment
Flame sensor type	Flame rod UV
Modulation output	4-20ma 0-10V Fan PWM
Blower/HSI	Blower Hot surface ignitor
Temperature units	Fahrenheit Celsius

Table 32. R7911 System Configuration Parameters. (Continued)

Parameter	Comment
Anti short cycle time	___ hour ___ min ___ sec
Alarm silence time	___ day ___ hour ___ min
Power up with lockout	Clear lockout Do NOT clear lockout
Inlet connector type	0-15 psi 0-150 psi UNCONFIGURED
Stack connector type	10k NTC dual safety 10k NTC single non-safety 12k NTC single non-safety UNCONFIGURED
Header	4-20ma UNCONFIGURED

## Fan Parameters

Table 33 displays fan parameters.

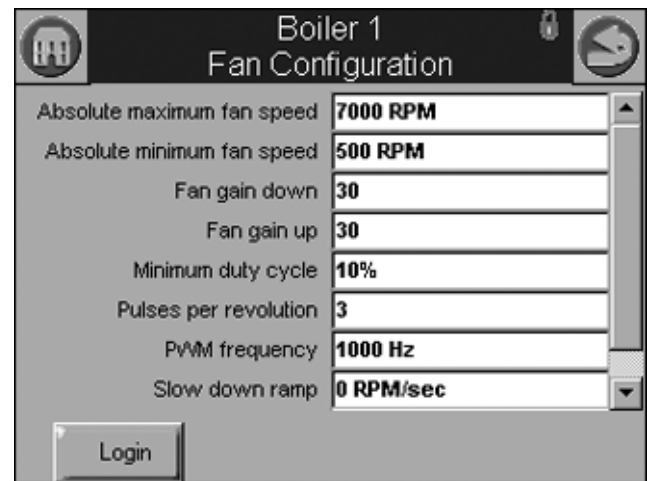

Fig. 67. Fan configuration.

Table 33. Fan Configuration Parameters.

Parameter	Comment
Absolute maximum fan speed	500–12000 RPM
Absolute minimum fan speed	500–12000 RPM
Fan gain down	0-100
Fan gain up	0-100
Minimum duty cycle	1-100%
Pulses per revolution	1-10
PWM frequency	1000 2000 3000 4000
Slow down ramp	0-12000 RPM/sec
Speed up ramp	0-12000 RPM/sec

## Lead Lag Slave Configuration Parameters (Hydronic Control Only)

Table 34 displays Lead Lag Slave Configuration parameters.

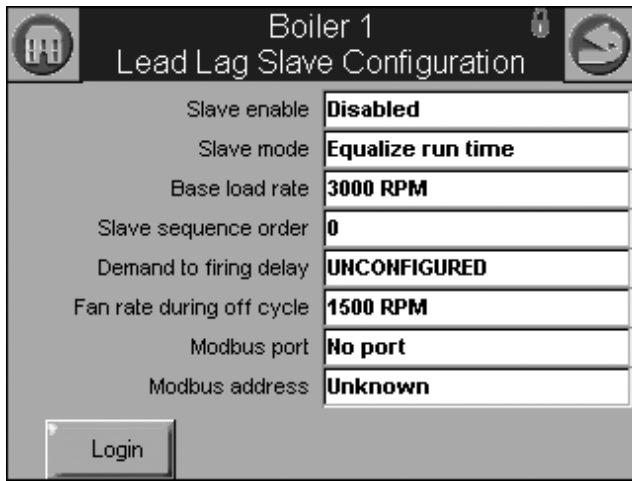

Fig. 68. Lead Lag slave configuration.

Table 34. Lead Lag Slave Configuration Parameters.

Parameter	Comment
Slave enable	Slave ModBUS slave Disabled
Slave mode	Use first Use last Equalize run time
Base load rate	0–6000 rpm
Slave sequence order	0–8
Demand to firing delay	___hour ___min ___sec
Fan rate during off cycle	0–12000 rpm
ModBus port	MB1 MB2 No port
ModBus address	0–250

## Lead Lag Master Configuration Parameters (Hydronic Control Only)

Table 35 displays Lead Lag Master Configuration parameters.

Click the Advanced Settings button to see available advanced parameters as shown in Table 36–44.

Use the left and right arrows to switch between Modulation, CH, DHW, Frost Protection, Warm Weather Shutdown, Algorithms, Rate Allocation, Add stage and Drop stage parameters.

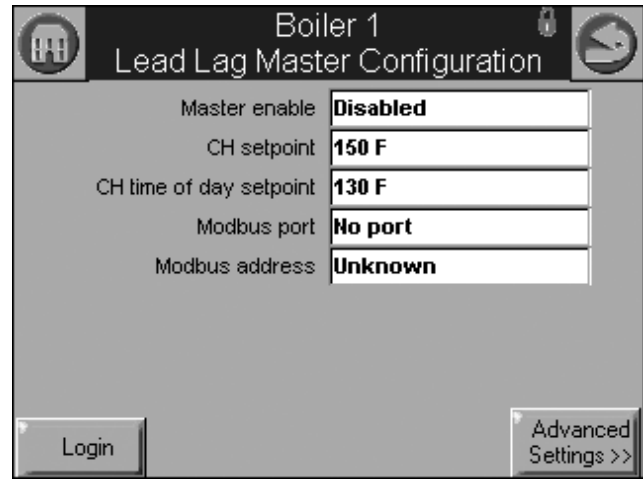

Fig. 69. Lead Lag master configuration and Advanced Settings button.

Table 35. Lead Lag Master Configuration Parameters.

Parameter	Comment
Master enable	Enabled Disabled
CH setpoint	-40 °F to 266 °F (-40 °C to 130 °C)
CH time of day setpoint	-40 °F to 266 °F (-40 °C to 130 °C)
ModBus port	MB1 MB2 No port
ModBus address	1–250

Table 36. Lead Lag Master Configuration Advanced Settings: Modulation Parameters.

Parameter	Comment
Modulation backup sensor	Lead outlet sensor Slave outlet sensor average Disabled
Off hysteresis	0 °F to 234 °F (-17 °C to 112 °C)
On hysteresis	0 °F to 234 °F (-17 °C to 112 °C)
Hysteresis step time	___Hour ___Minute ___Second
P gain	0 - 400
I gain	0 - 400
D gain	0 - 400

**Table 37. Lead Lag Master Configuration  
Advanced Settings: Central Heat Parameters.**

Parameter	Comment
Demand switch	Stat Remote Stat ModBus Stat Disabled
Setpoint source	Local ModBus 4-20 ma
Setpoint	-40 °F to 266 °F (-40 °C to 130 °C)
Time of day setpoint	-40 °F to 266 °F (-40 °C to 130 °C)
4 ma water temperature	-40 °F to 266 °F (-40 °C to 130 °C)
20 ma water temperature	-40 °F to 266 °F (-40 °C to 130 °C)
Outdoor reset	Enabled Disabled

**Table 38. Lead Lag Master Configuration  
Advanced Settings: DHW Parameters.**

Parameter	Comment
Priority source	DHW heat demand Disabled
Priority method	Boost during priority time Drop after priority time
DHW priority override time	___ Hour ___ Minute ___ Second

**Table 39. Lead Lag Master Configuration  
Advanced Settings: Frost Protection Parameters.**

Parameter	Comment
Enable	Enabled Disabled
Outdoor setpoint	-40 °F to 266 °F (-40 °C to 130 °C)
Frost protection rate	___%

**Table 40. Lead Lag Master Configuration Advanced  
Settings: Warm Weather Shutdown Parameters.**

Parameter	Comment
Enable	Enabled Disabled
Setpoint	-40 °F to 266 °F (-40 °C to 130 °C)

**Table 41. Lead Lag Master Configuration  
Advanced Settings: Algorithms Parameters.**

Parameter	Comment
Lead selection method	Sequence order Measured run time
Lag selection method	Sequence order Measured run time
Lead rotation time	___ day ___ hour ___ min
Force lead rotation time	___ day ___ hour ___ min

**Table 42. Lead Lag Master Configuration  
Advanced Settings: Rate Allocation Parameters.**

Parameter	Comment
Base load common	? %

**Table 43. Lead Lag Master Configuration  
Advanced Settings: Add Stage Parameters.**

Parameter	Comment
Method	Error threshold Firing rate threshold Disabled
Detection time	___ Hour ___ Minute ___ Second
Error threshold	0 °F to 234 °F (-17 °C to 112 °C)
Rate offset	± _____ %
Interstage delay	___ Hour ___ Minute ___ Second

**Table 44. Lead Lag Master Configuration  
Advanced Settings: Drop Stage Parameters.**

Parameter	Comment
Method	Error threshold Firing rate threshold
Detection time	___ Hour ___ Minute ___ Second
Error threshold	0 °F to 234 °F (-17 °C to 112 °C)
Rate offset	± _____ %
Interstage delay	___ Hour ___ Minute ___ Second

## DETAILS

Details of the hydronic or steam system is accomplished through the detail status pages. The detail status page is shown below.

Screens will appear only if they are configured for your system.

Information shown is current status. For example: firing rate is the current fan speed or motor position; timing shown is current time Sola is at.

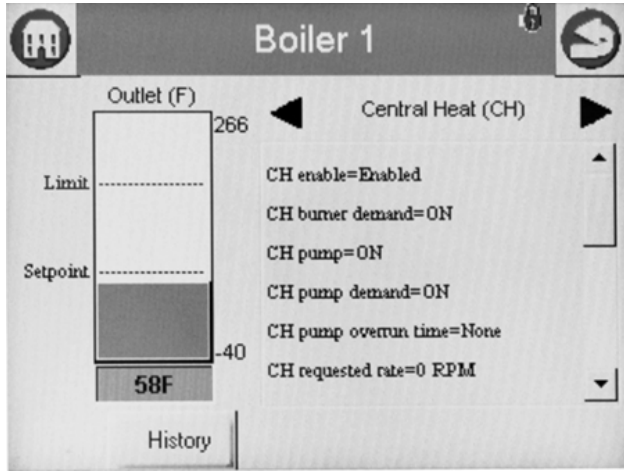

Fig. 70. Hydronic CH detail status page.

Status information on the detail status page is organized into groups and displayed on the page one group at a time. The user moves from one group to another using the left and right arrow buttons.

Status data on the detail status page is displayed in a menu for the group that is currently displayed. If more status items exist in the group than will fit on the screen, a vertical scroll bar allows the user to see all status data. If the user selects a line of status data in the menu, it will expand in bigger, more easily readable text, as show in Fig. 71. Additional information about Status data and groups that are displayed are provided in the R7910A or R7911 Status section of this document.

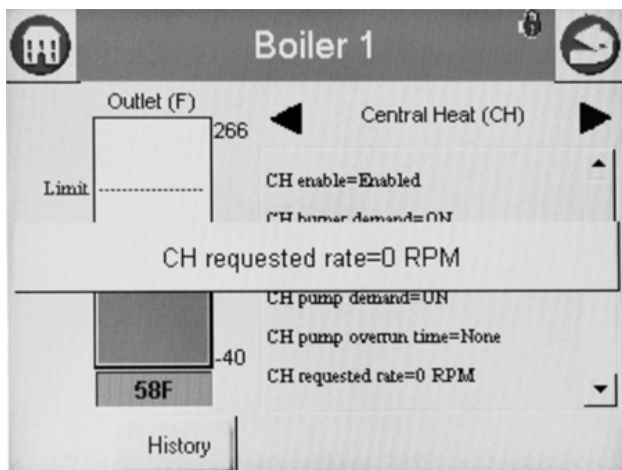

Fig. 71. Hydronic “expanded” detail status.

## R7910A or R7911 Status

Data in Tables 45–Table 56 are displayed on the R7910A Hydronic or R7911 Steam status pages. A complete list of Status tables can be found in Table 60 on page 53.

The CH status data shown in Table 45 displays first when the CH Hydronic heating loop is selected on the Home page.

Table 45. CH Hydronic Status.

Data	Comment
CH enable	Enabled, Disabled
CH burner demand	On or Off
CH pump	On or Off
CH pump demand	On or Off
CH pump overrun time	Running overtime for CH pump (seconds)
CH requested rate	RPM or %
CH OFF setpoint	Setpoint plus hysteresis
CH setpoint	Temp setting between -40 °F to 266 °F (-40 °C to 130 °C)
CH ON setpoint	Setpoint minus hysteresis
CH setpoint source	Normal, TOD, Outdoor reset, Remote control
CH status	Disabled, Normal, Suspended
Demand source	Sensor only, Sensor and Stat terminal, Sensor and Remote Stat, LCI and sensor
Outlet high limit	Yes or No
Outlet high limit setpoint	Temp setting between -40 °F to 266 °F (-40 °C to 130 °C)
Outlet sensor state	None, Normal, Open, Shorted, Outside high range, Outside low range, Not reliable (None = no outlet sensor)
Outlet temperature	Outlet temperature (same as bar graph)

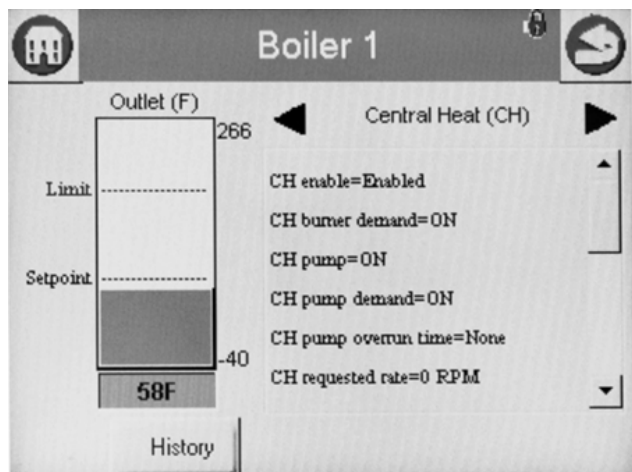

Fig. 72. CH Hydronic Status menu (top).

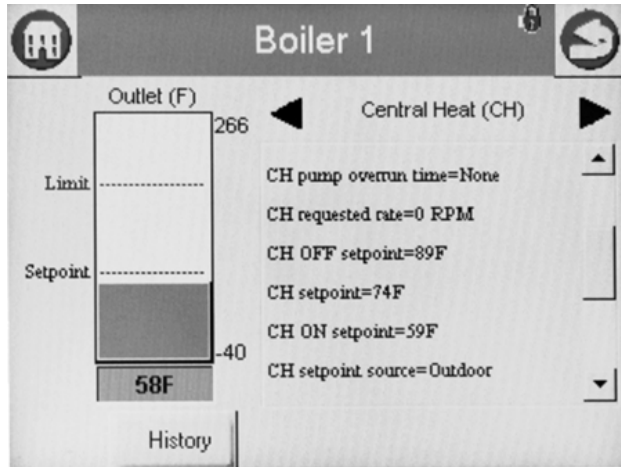

Fig. 73. CH Hydronic Status menu (middle).

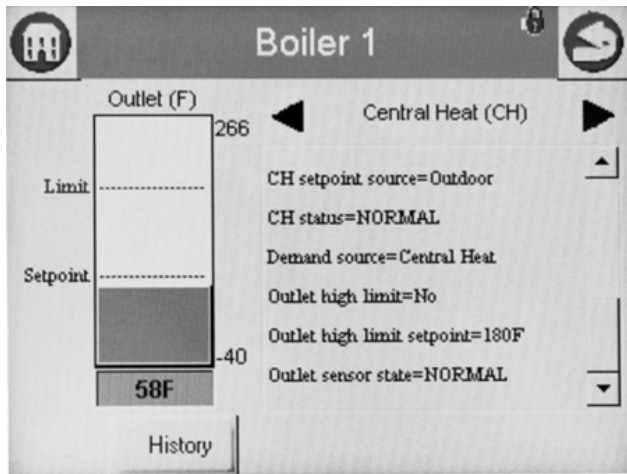

Fig. 74. CH Hydronic Status menu (bottom).

The status data in Table 46 displays first when the DHW Hydronic heating loop is selected on the Home page. Scrolling through the status groups eventually shows both.

Table 46. DHW Hydronic Status.

Data	Comment
DHW enable	Enabled, Disabled
Demand source	Unknown, No source demand, CH, DHW, Lead Lag, CH frost protection, DHW frost protection, No demand due to burner switch
DHW burner demand	On or Off

Table 46. DHW Hydronic Status. (Continued)

Data	Comment
DHW high limit	Temp setting between -40 °F to 266 °F (-40 °C to 130 °C)
DHW high limit setpoint	Temp setting between -40 °F to 266 °F (-40 °C to 130 °C)
DHW priority override time	0-600 seconds
DHW pump	On or Off
DHW pump demand	On or Off
DHW pump overrun time	Running overrun time for DHW pump (seconds)
DHW requested rate	RPM or %
DHW sensor state	None, Normal, Open, Shorted, Outside high range, Outside low range, Not reliable (None = no outlet sensor)
DHW OFF setpoint	Setpoint plus hysteresis
DHW setpoint	Temp setting between -40 °F to 266 °F (-40 °C to 130 °C)
DHW ON setpoint	Setpoint minus hysteresis
DHW setpoint source	Normal, TOD, Outdoor reset
DHW status	Disabled, Normal, Suspended
DHW temperature	DHW temperature (same as bar graph)

The bar graph displayed for the CH control loop (hydronic) is the outlet sensor temperature; for the DHW control loop it is the DHW sensor temperature. When no analog DHW sensor is installed (digital switch instead), the inlet sensor temperature is displayed.

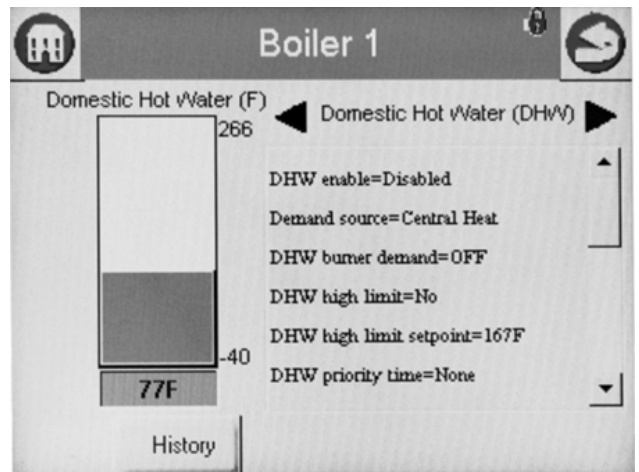

Fig. 75. DHW Hydronic Status menu (top).

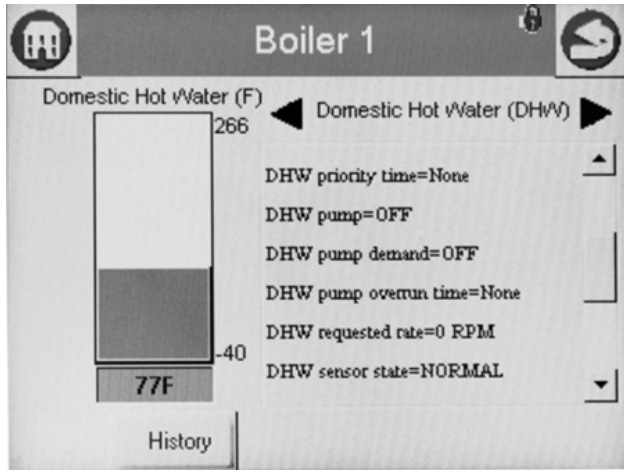

Fig. 76. DHW Hydronic Status menu (middle).

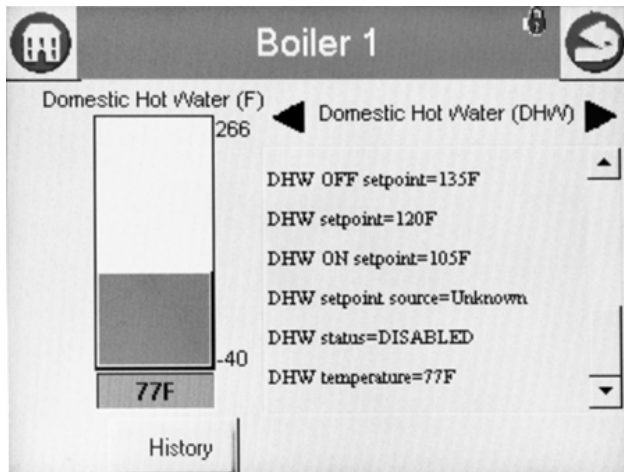

Fig. 77. DHW Hydronic Status menu (bottom).

Table 47. Burner Control Status. (Continued)

Data	Comment
Firing rate	% or RPM. Adjustable when firing rate control set to Manual.
Firing rate control	Auto or Manual
Flame signal	Flame signal strength
Hold code	Description of hold message if locked out
Lockout	Description of lockout message if locked out
Pilot test hold	Off or Hold
Remote STAT	On or Off

Note: Steam will show Steam psi as the bar graph

The bar graph displayed for this status is the outlet sensor temperature.

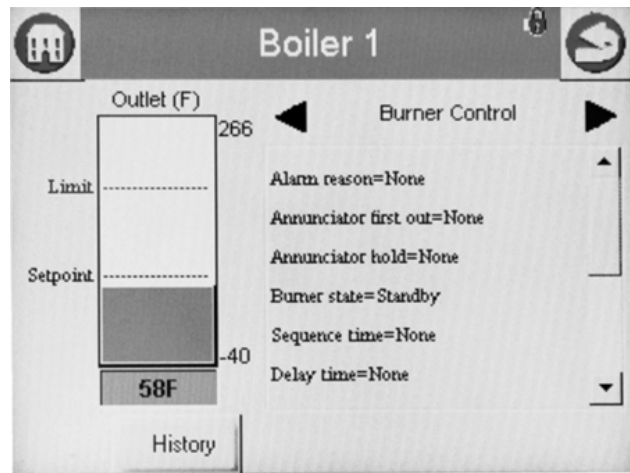

Fig. 78. Burner Control Status menu (top).

## Burner Control Status

The Burner Control status page will display the status data shown in Table 47.

Table 47. Burner Control Status.

Data	Comment
Alarm reason	Description for alarm being on (maybe lockout or a hold message)
Annunciator first out	First annunciator input related to lockout
Annunciator hold	First annunciator input related to hold
Burner state	Disabled, Locked out, Anti-short cycle, Unconfigured safety data, Standby Hold, Standby, Delay, Normal Standby, Preparing, Firing, Postpurge
Sequence time	Running time for timed burner control operation (seconds)
Delay time	Running display of delay time when burner control in delay state.

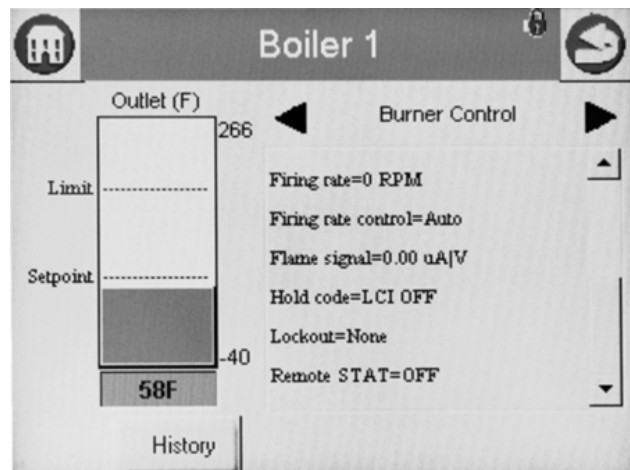

Fig. 79. Burner Control Status menu (bottom).

Burner control can be turned on and off in the R7910A or R7911 by the user.



## Hydronic Demand and Modulation Status

Table 49 displays the status page data for R7910A.

**Table 48. Hydronic Demand and Modulation Status.**

Data	Comment
Demand source	CH, DHW, Lead Lag, or Frost Protection (parameter that has current priority)
Firing rate	% or RPM. Adjustable when firing rate control set to Manual.
Demand rate	% or RPM.
Rate limiter	None, Outlet high limit, Delta T limit, Stack limit, Slow start limit, Anti-condensation, Minimum modulation, Forced rate
Limited rate	% or RPM
Rate override	Burner control default, Burner control, manual firing rate off, None
Override rate	% or RPM

The bar graph displayed for this status is the outlet sensor temperature.

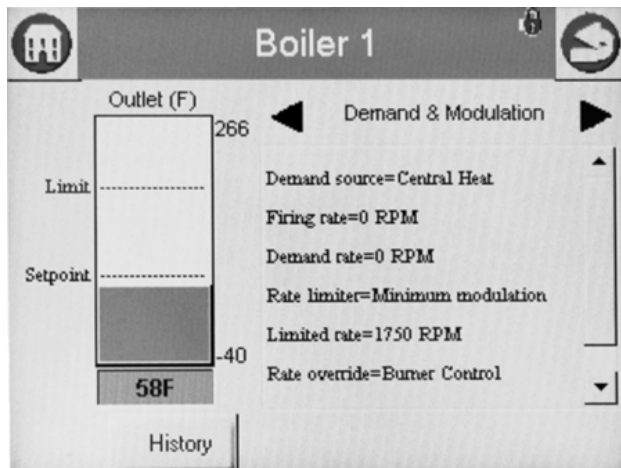

**Fig. 80. Demand and Modulation Status menu (top).**

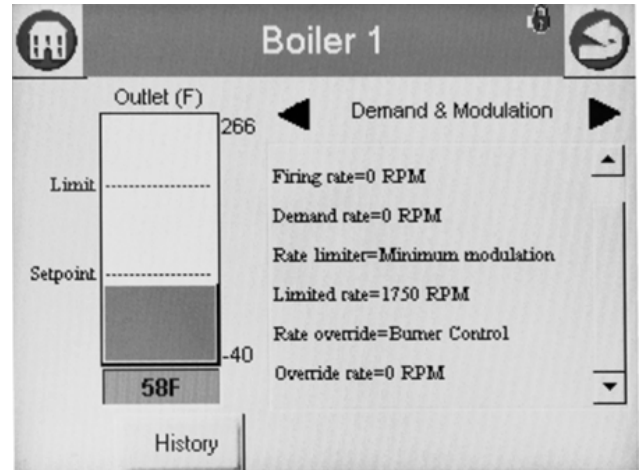

**Fig. 81. Demand and Modulation Status menu (bottom).**

## Inlet Temperature Status

Table 49 displays the status page data for R7910A inlet temperature.

**Table 49. Inlet High Limit Status.**

Data	Comment
Inlet sensor state	None, Normal, Open, Shorted, Outside high range, Outside low range, Not reliable (None=no outlet sensor)
Inlet temperature	Inlet sensor temperature (same as bar graph)

The bar graph displayed for this status is the inlet sensor temperature.

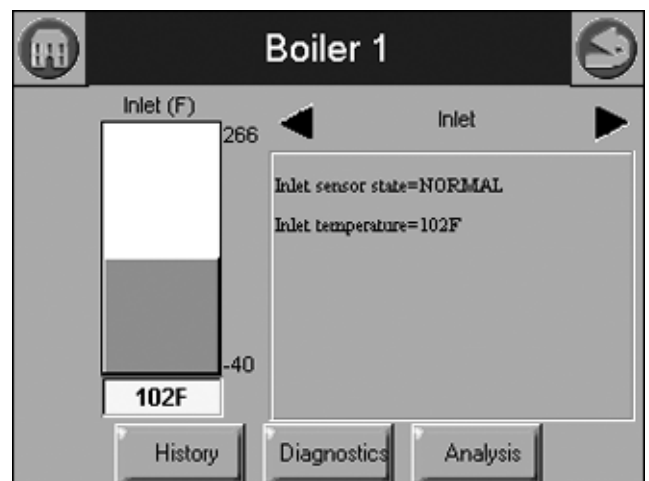

**Fig. 82. Inlet High Limit Status menu.**

## Fan Status

Table 50 displays the status page data for the fan in the control.

**Table 50. Control Fan Status.**

Data	Comment
Fan speed	% or RPM (current fan speed)
Maximum fan speed	Setpoint of maximum fan speed (% or RPM)
Minimum fan speed	Setpoint of minimum fan speed (% or RPM)

The bar graph displayed for this status is the fan speed.

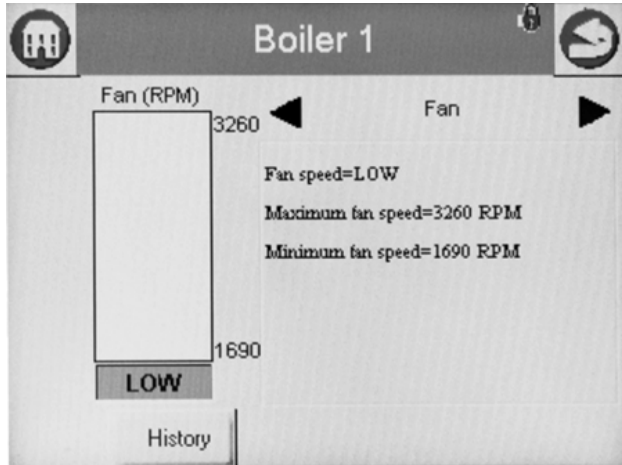

**Fig. 83. Control Fan Status menu.**

## Hydronic Pump Status

Table 51 displays the status page data for this example, Central Heat pump in the R7910A. Screens available for DHW, Boiler, System, Aux1 and Aux2 will be the same if that pump is configured.

**Table 51. Hydronic CH Pump Status.**

Data	Comment
CH Pump	On or Off
Controlling Pump Terminal	Pump A, B, or C
Status	On, Off, or Not Used
Delay time	Duration of delay time
Overrun time	Duration of overrun time
Frost overrun time	Duration of frost overrun time
Idle days	Number of days idle
Cycle count	Number of cycles

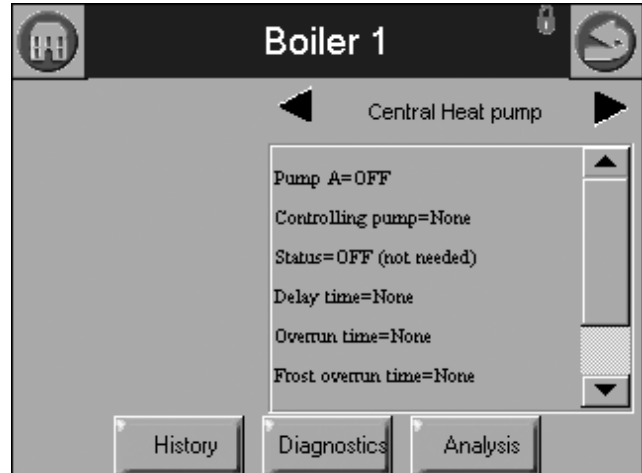

**Fig. 84. Hydronic CH pump status menu.**

## Flame Detection Status

The status data shown in Table 52 is displayed for flame detection in the R7910A or R7911.

**Table 52. Flame Detection Status.**

Data	Comment
Flame detected	Yes or No
Flame signal	Flame signal strength (same as bar graph)
Pilot test hold	Off or hold

The bar graph displayed for this status is the flame signal.

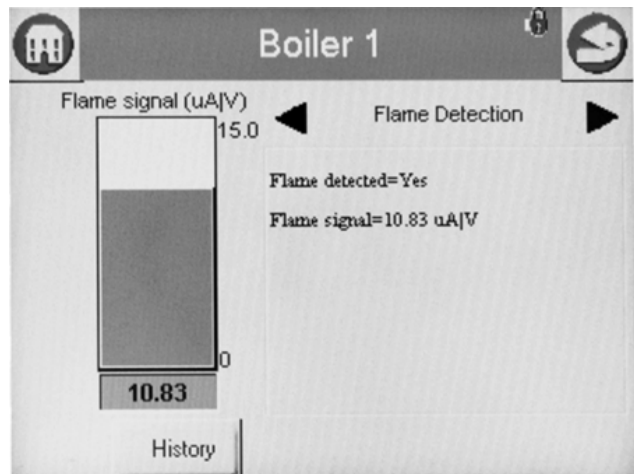

**Fig. 85. Flame Detection Status menu.**

NOTE: This same status is also displayed for burner control status. A separate status group is defined to provide a bar graph of the flame signal.

## Statistics Status

Table 53 displays the statistics status page data for the R7910A or R7911. Though the Steam control will not have a pump, the output can be used to run some other auxiliary equipment.

**Table 53. Control Statistics Status.**

Data	Comment
Burner cycles	Number of cycles
Burner run time	Duration of run time
CH pump cycles	Number of cycles
System pump cycles	Number of cycles
Controller cycles	Number of cycles
Controller run time	Duration of run time

The bar graph displayed for this status is the outlet sensor temperature.

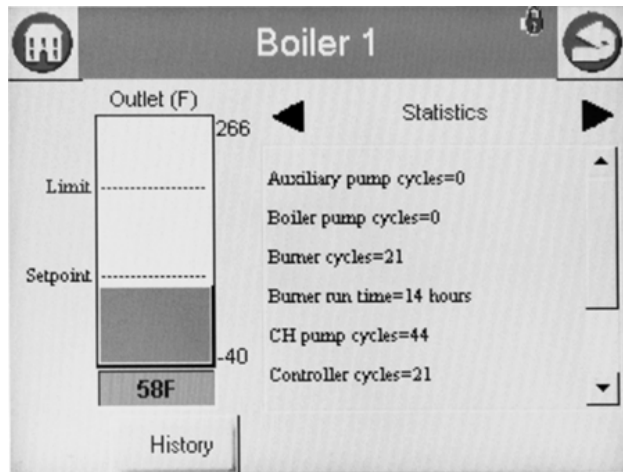

**Fig. 86. Control Statistics Status menu (top).**

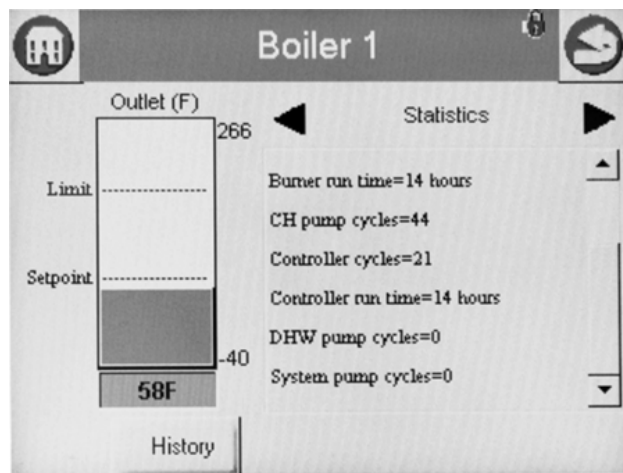

**Fig. 87. Control Statistics Status menu (bottom).**

## Stack Limit Status

Table 54 shows the status page data for the control Stack Limit.

**Table 54. Stack Limit Status.**

Data	Comment
Stack limit enable	Enabled or Disabled
Stack limit	Temp setting between -40 °F to 266 °F (-40 °C to 130 °C)
Stack limit setpoint	Temp setting between -40 °F to 266 °F (-40 °C to 130 °C)
Stack sensor state	None, Normal, Open, Shorted, Outside high range, Outside low range, Not reliable (None=no stack temp sensor)
Stack temperature	Stack sensor temperature (same as bar graph)

The bar graph displayed for this status is the stack sensor temperature.

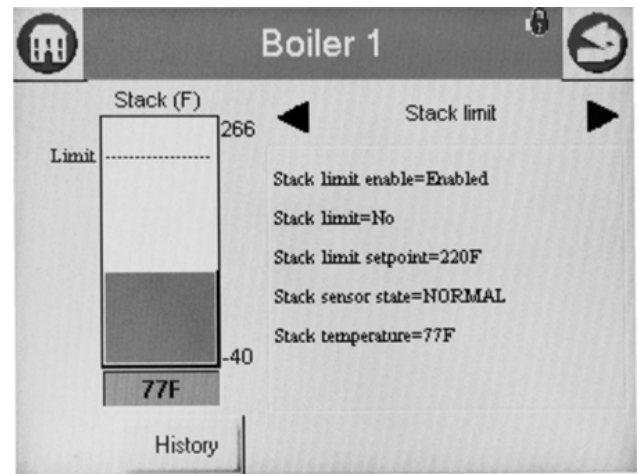

**Fig. 88. Stack Limit Status menu.**

## Lead Lag Slave Status - Hydronic Only

Table 55 shows the status page data for Lead Lag Slave.

**Table 55. Lead Lag Slave.**

Data	Comment
Type	Slave
Command Received	Yes/No
Demand	Off
Request Rate	RPM
Burner Control	Standby
Modulating	No
Priority	

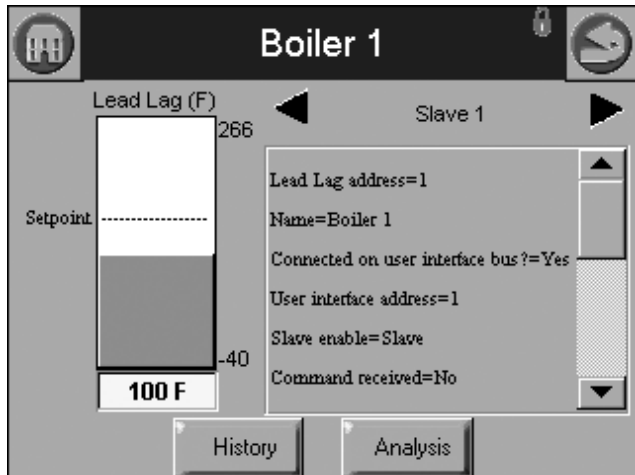

Fig. 89. Lead Lag Slave Status menu.

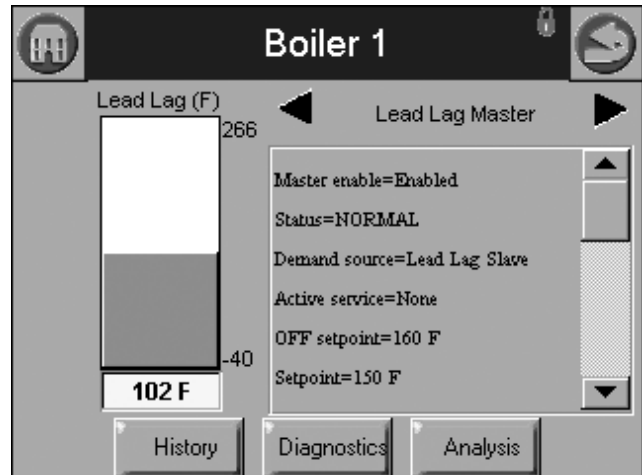

Fig. 90. Lead Lag Master Status menu.

## Lead Lag Master Status - Hydronic Only

Table 56 shows the status page data for Lead Lag Master.

Table 56. Lead Lag Master.

Data	Comment
Master enabled	Enabled
Status	normal
Demand source	Lead lag slave
Active Service	None
Off setpoint	160 °F (71 °C)
Setpoint	150 °F (66 °C)
On setpoint	145 °F (63 °C)
operating temperature	150 °F (66 °C)
Sensor state	normal
Sensor temperature	150 °F (66 °C)
Slave firing	no
Stager state	idle
Stager timer	
CH demand	
CH frost demand	no
DHW frost demand	no

## R7910A OR R7911 DIAGNOSTICS

The diagnostic page displays analog and digital I/O status of the control. The digital I/O data is displayed as LEDs that are either on (green) or off (red) (see Fig. 91–93). Not all digital I/O can be displayed at the same time on the page, so a horizontal scroll bar is used to move the view left and right to show all digital I/O data.

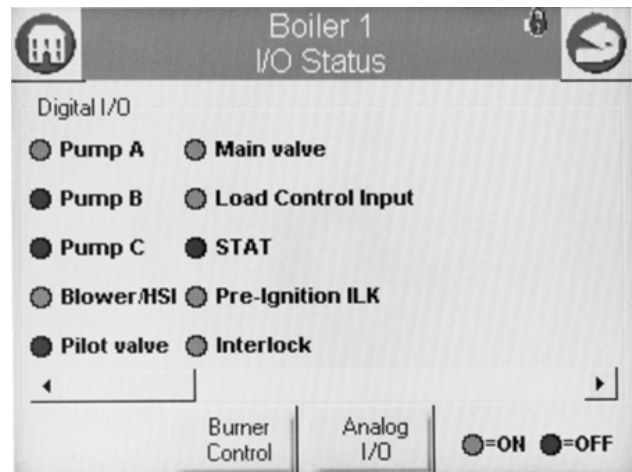

Fig. 91. Diagnostic digital I/O page (left).

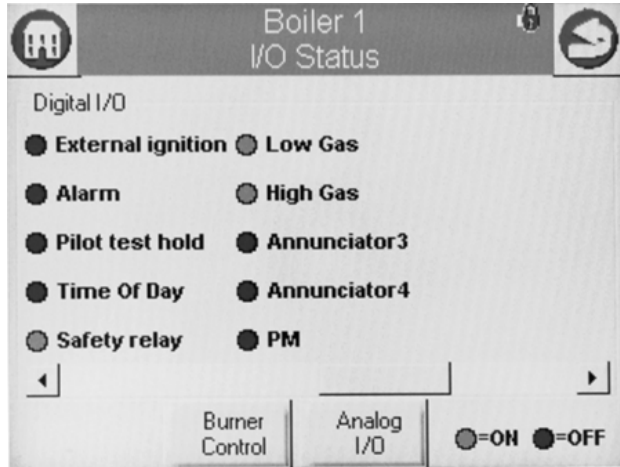

Fig. 92. Diagnostic digital I/O page (center).

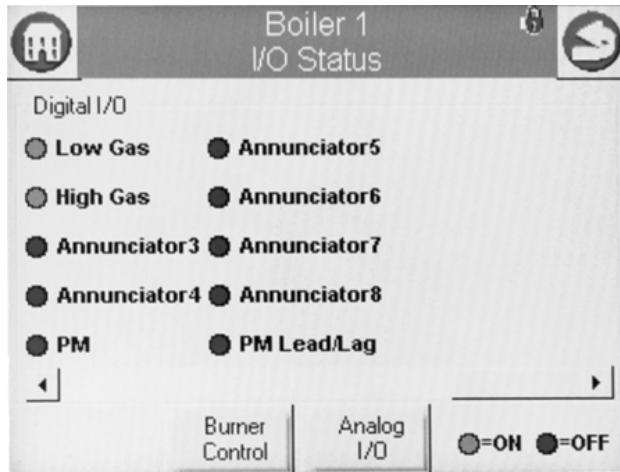

Fig. 93. Diagnostic digital I/O page (right).

Temperature sensors or pressure sensors also display the current sensor state, (i.e., whether there is a fault condition or the sensor is in a normal monitoring state). The user can toggle between displaying the control digital and analog I/O (the initial display is the digital I/O). The Digital or Analog button on the bottom of the diagnostic page changes the I/O displayed to the type indicated by the button.

The following data is displayed on the control diagnostics page (see Fig. 91–93).

Table 57. Control Digital I/O Data.

Data	Comment
Pump A	On/Off
Pump B	On/Off

Table 57. Control Digital I/O Data.

Data	Comment
Pump C	On/Off
Blower/HSI	On/Off
Pilot valve	On/Off
Main valve	On/Off
Load Control Input	On/Off
STAT	On/Off
Pre-ignition interlock	On/Off
Interlock	On/Off
External ignition	On/Off
Alarm	On/Off
Pilot test hold	On/Off
Time Of Day	On/Off
Safety relay	On/Off
Low Gas	On/Off
High Gas	On/Off
Annunciator 3	On/Off
Annunciator 4	On/Off
PM	On/Off
Annunciator 5	On/Off
Annunciator 6	On/Off
Annunciator 7	On/Off
Annunciator 8	On/Off
PM Lead/Lag	On/Off

“On” status is indicated by a green LED and “Off” status is indicated by a red LED.

Table 58. Control Analog I/O Data.

Data	Comment
Outlet	
Inlet	If enabled
Firing rate	% or RPM
Flame signal	V
Fan speed	RPM (if applicable). Should match with firing rate.
Domestic Hot Water	If enabled
Stack	If enabled
Outdoor	If enabled
Header	If enabled

Analog I/O data is displayed as bar charts depicting the I/O level (see Fig. 94). Analog I/O that is not enabled for the installation displays a blank I/O level. To see all analog I/O, use the horizontal scroll bar to move the view left and right.

## INSTALLER CHECKOUT

### Diagnostics Tests

Pressing the Diagnostics Test button launches the diagnostic tests. The first test displayed on the right side of the screen is the last selected test shown, as seen in Fig. 97.

This screen enables the user to perform the following tests:

**Modulation Test:** enables the user to verify that the burner is firing at the correct rate. (See Fig. 97.)

**Pilot Test:** enables the user to verify that the pilot valve is functioning properly. The user can also perform burner adjustments for the pilot flame. (See Fig. 98.)

**Pump Test:** enables the user to verify that the correct pump is on or off. The Start Test button will test all pumps; pressing an individual pump tests that pump only. (See Fig. 99.)

**Burner Switch:** this button turns the burner on or off.

**Start Test:** runs the test for 5 minutes.

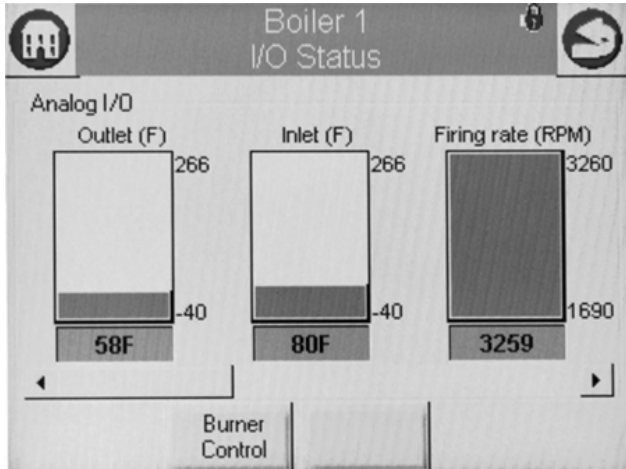

Fig. 94. Diagnostics analog I/O page (left).



Fig. 95. Diagnostics analog I/O page (center).

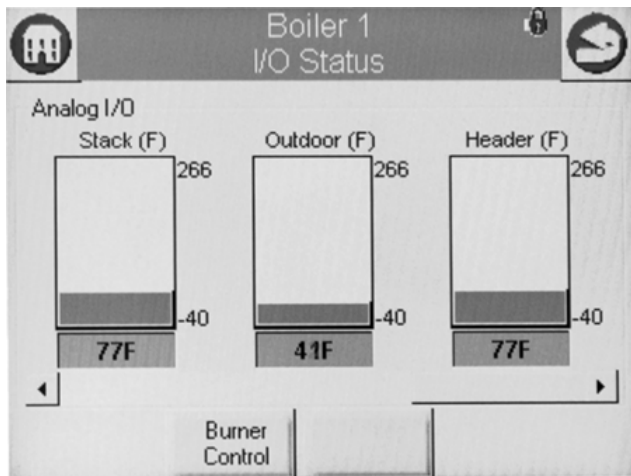

Fig. 96. Diagnostics analog I/O page (right).

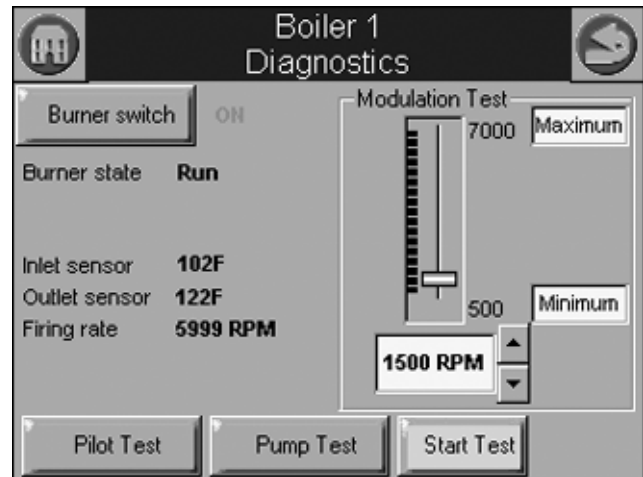

Fig. 97. Modulation test.

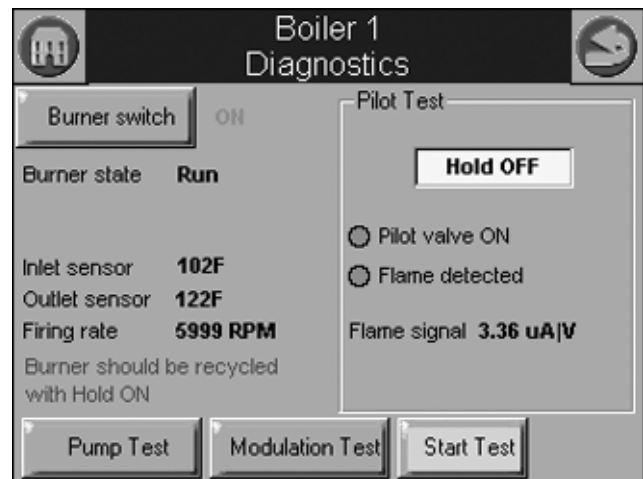

Fig. 98. Pilot test.

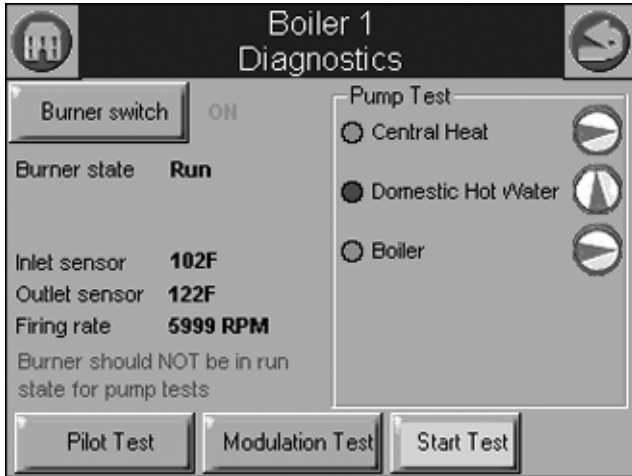

Fig. 99. Pump test.

## S7999B OR S7999C DISPLAY SETUP AND DIAGNOSTICS

The following pages apply to display setup and diagnostics for the S7999B or S7999C OI Displays.

### Setup

The Setup button on the Home page (for S7999B OI Display) or Display Setup Button on the Configuration Screen for the S7999C OI Display is selected to go to these pages. The Setup screen (see Fig. 100) is displayed first. It allows for some OI Display settings. The Advanced Setup button permits the user to run some diagnostic functions for the display and to set advanced features for run-time operation. See "Advanced Setup" on page 48 for these features.

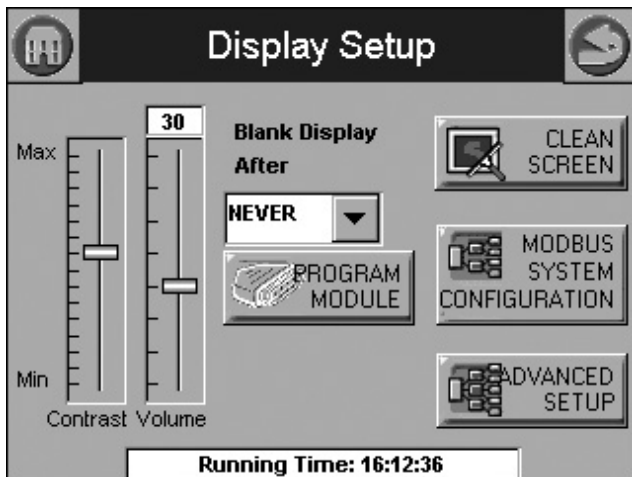

Fig. 100. R7910A setup.

If Contrast or Volume are changed, Fig. 101 displays to allow saving these changes.

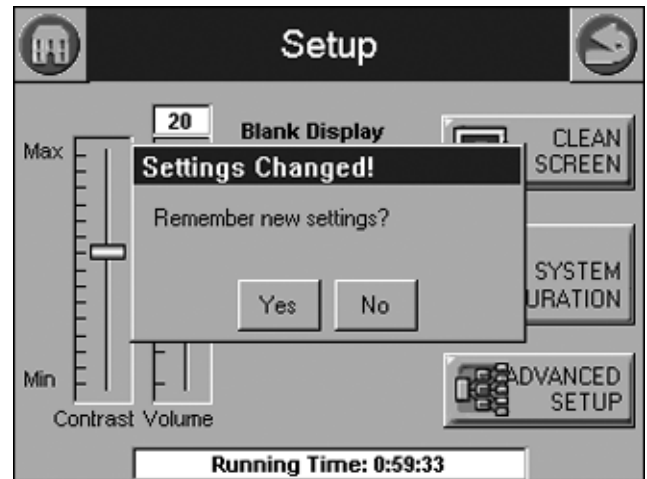

Fig. 101. Setup settings changed.

### Cleaning the Screen

When the user wants to clean the touch screen, the CLEAN SCREEN button is selected to freeze touch input temporarily for 30 seconds to allow the user to clean the screen. (See Fig. 102.)

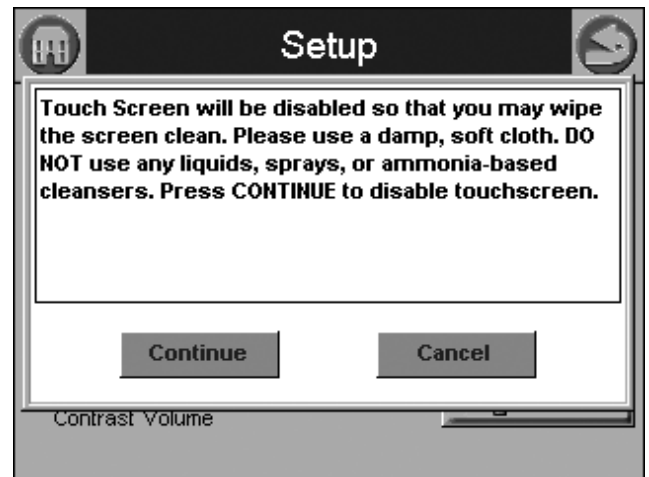

Fig. 102. Clean screen setup.

A countdown screen (Fig. 103) displays during the screen disable period. It disappears when the touch screen is re-enabled.

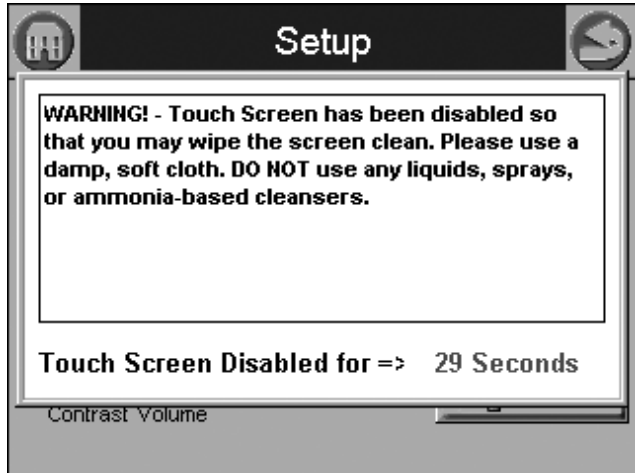

Fig. 103. Screen disabled for cleaning.

Pressing the SYSTEM CONFIGURATION button starts up the system configuration. For more information, see “System Configuration (S7999B OI DisplayOnly)” on page 19.

Pressing the ADVANCED SETUP button starts the Advanced Setup.

## ADVANCED SETUP

Pressing the ADVANCED SETUP button on the Setup page displays more options that can be set by the user (Fig. 104).

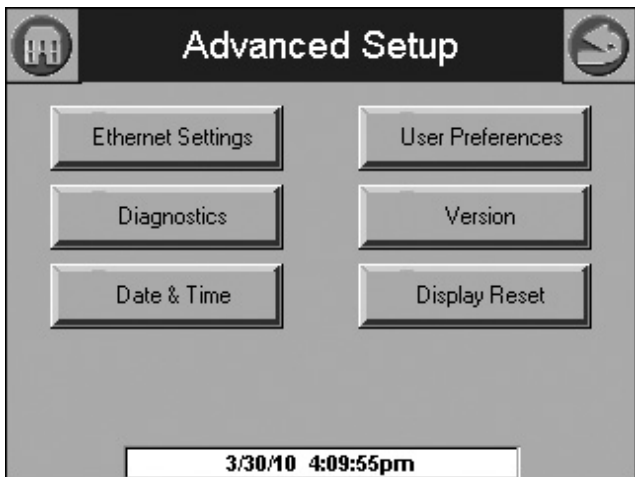

Fig. 104. Advanced Setup.

### Ethernet Settings (S7999B Only)

Ethernet Settings is used to enable Ethernet communications for remote diagnostics, file transfers, and remote support, and is not typically enabled (Fig. 105). This feature should remain disabled unless directed to do so for remote troubleshooting. Once the feature is enabled, the S7999B must be reset to start it at power-up. The Ethernet interface can also be used to transfer profile curve files to/from the S7999B over a local intranet or the Internet.

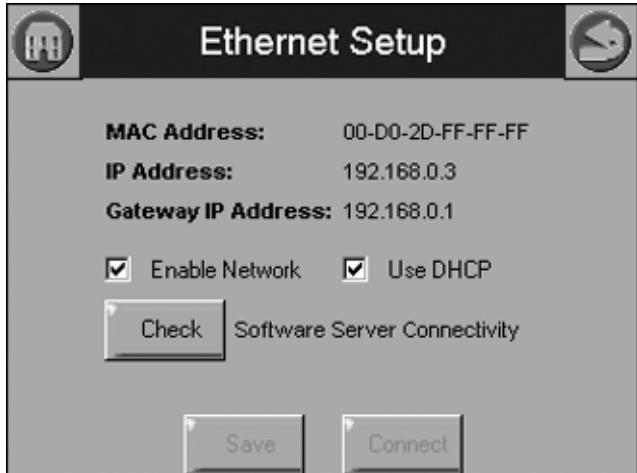

Fig. 105. Ethernet settings.

A Honeywell software server connectivity check can be performed by selecting the Check button. This button is only enabled when the Ethernet interface is enabled and active. The connectivity check tries for 15 seconds to connect to the Honeywell software server. Successful connection displays a “CONNECTED” message on the screen. An unsuccessful attempt displays “NOT CONNECTED.”

The MAC (Media Access Control) address is a hardware address that uniquely identifies the S7999B on the network. This information is likely only of interest to the network administrator.

The IP (Internet Protocol) address is the address that the S7999B has been assigned by the DHCP server in the local network to use for others to access the S7999B. This address is necessary for the remote user to identify the S7999B in an FTP (File Transfer Protocol) application for transferring trend analysis information. Like the MAC address, it is displayed for informational purposes for the network administrator.

If the IP address has a private network designation (192.x.x.x), remote access from outside the local network may not be possible. Contact the network administrator for assistance in this case. If the IP address is 255.255.255.255, then no IP assignment has been made, and there is no connection to the network. This possibility could be due to no physical connection to an Ethernet network, or there is no DHCP server present on the Ethernet network. Check with the network administrator for assistance.

The Gateway IP address is displayed for informational purposes for the network administrator. The gateway node provides remote access for devices located off of the local network to the S7999B.

The Enable Network checkbox specifies that the Ethernet interface is on or not when the S7999B is powered up. The selection must be saved to permanent storage (flash) with the Save button for it take effect at boot time. This checkbox should normally be disabled, and enabled when Ethernet access to the S7999B is necessary. This interface must also be enabled for the Software Server Connectivity check to function properly (the Check button). If the Ethernet interface is disabled, the check procedure fails.



The S7999B must be assigned an IP address by a DHCP server for it to operate on the local network, so the Use DHCP box should be checked. However, because the S7999B requires this feature, it ignores the checkbox and always regards it as checked. The checkbox is included for future purposes when dynamic IP addressing isn't required.

### Trend Analysis Page (S7999B Only)

Trend analysis of R7910 or R7911 status data can be viewed on the S7999B. A graph displays a historical view of R7910 or R7911 status data over varying time periods.

A 2-dimensional graph with status data values shown on the Y axis over time specified on the X axis is displayed. Status for the most recent time is represented on the left side of the graph with older status running towards the right side of the graph.

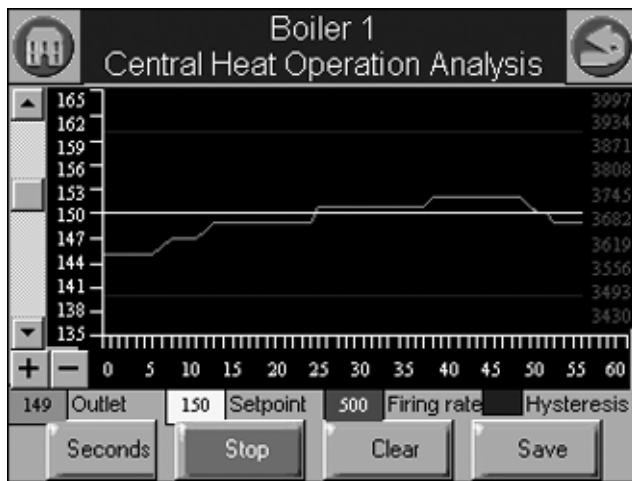

Fig. 106. Trend analysis page.

Up to 4 R7910 or R7911 status variables can be viewed at the same time on one trend analysis graph. Select the status variables for the graph on the menu page (see Fig. 107). This menu displays when the Trend Analysis button is selected on the R7910 or R7911 status page.

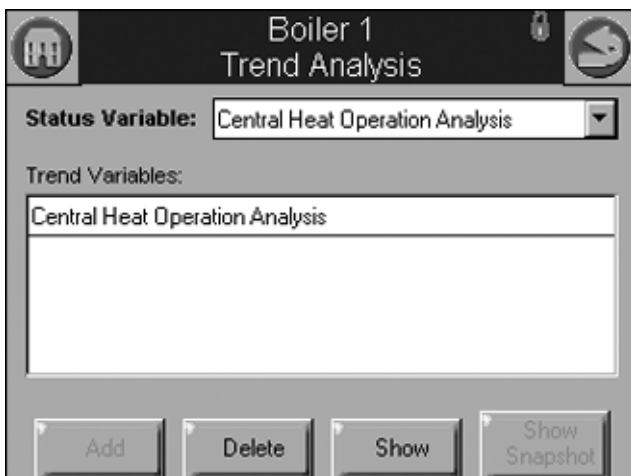

Fig. 107. Trend analysis menu page.

The status variable with the largest range (minimum to maximum) is used as the Y-axis range in the graph.

As the status variables are selected they are listed in a trend variables list box. The user chooses the status variables from a drop down menu and then presses the Add button to add each status variable to the trend variable list. See Fig. 108. After all status variables have been selected press the Show button to view the trend analysis graph.

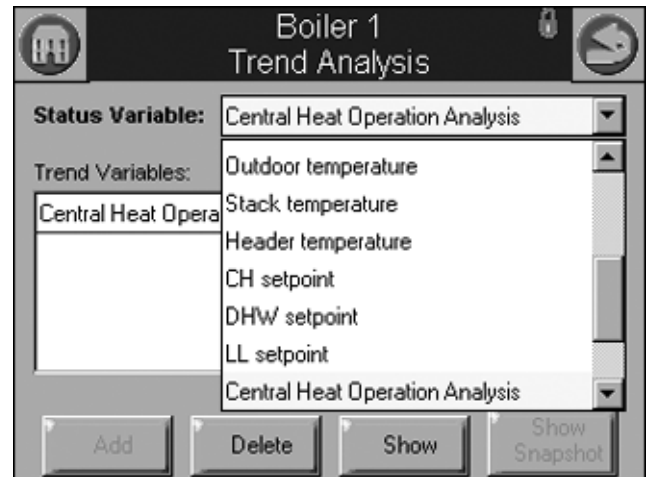

Fig. 108. Trend analysis menu page.

Each status variable displayed in the trend analysis is represented by a different colored line, as follows:

1. First status variable = green
2. Second status variable = yellow
3. Third status variable = red
4. Fourth status variable = blue

No more than two different measurement units (such as degrees), are allowed for the status variables selected in the trend analysis graph. Attempts to add a status variable with a third measurement unit are rejected.

A second Y axis is displayed on the right side of the graph to represent the scale for the second measurement unit. This can result in minor clipping of the curves on the right side, as shown in Fig. 109 and 110.

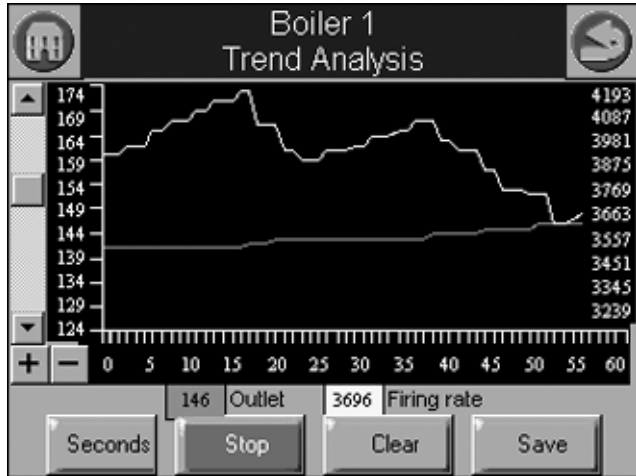

Fig. 109. Trend analysis page with firing rate.

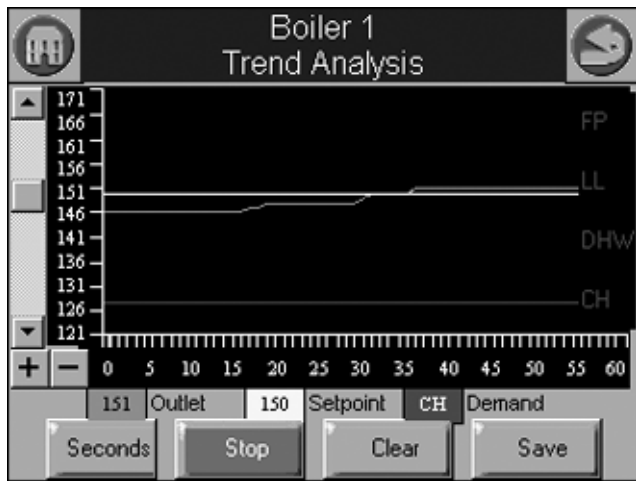

Fig. 110. Trend analysis page with demand source.

If any of the status variables has degrees as a unit of measurement, degrees is used for the main Y axis (on the left of the graph). The status variables selected are saved and are displayed by default when the trend analysis menu page is first displayed. Status data is updated on the graph with new status at the same rate as the sample time period selected. The current sample time period is displayed in a button on the page (in Fig. 109 and 110, the button is “Seconds”).

Status older than the sample time period is dropped from the right end of the curve as newer status appears on the left end of the curve.

Trend data can be viewed in one-second (most recent 60 second time period), 15-second (most recent 15-minute time period), and hour (most recent 24 hour time period) intervals.

NOTE: Full graphs require that the S7999B has been monitoring the R7910 or R7911 for the complete time period. Partial graphs display if this is not the case.

The buttons at the bottom can be used to change the view of the graph. The user can change the sample rates of the display by pressing the Seconds, Minutes, Hours, or Days button (the button changes depending on what sample rate is currently displayed). The + and - buttons zoom in and out of

the graph so the Y axis depicts different degrees of detail for the data range. The viewing window can be moved up and down the graph to see the complete range when zoomed in.

The smallest measurement interval is a single whole digit (no fractional precision) when the entire range exceeds 10 units, e.g., 20–30 degrees.

Pressing the Stop button will pause trend data updates of the graph. The graph “freezes” the view when stopped. However, trend data sampling from the R7910 or R7911 continues regardless whether the graph update is stopped or not. Restarting the updates causes the graph to be refreshed with the latest data samples.

Pressing the Clear button will clear the trend sample data for an R7910 or R7911. All trend data for the R7910 or R7911 is cleared including status variables that are not included in the graph. The user is asked to confirm this action before proceeding.

NOTE: For system trend analysis graphs the Clear button isn’t present, so no status variables can be cleared.

A snapshot of the trend analysis graph can be taken and saved to the S7999B. The user is asked to confirm the save before it occurs.

NOTE: While this snapshot is saved, trend data sampling for all R7910s or R7911s is temporarily halted. Gaps or static level values occur in the trend data as a result.

The date and time that the snapshot is taken is stored with the snapshot. Only the status variables displayed in the graph are stored in the snapshot. All raw sample data for the status variables are stored so that any sample rate can be viewed offline.

Sample data stored in snapshot is either the real-time status at the time that the Save button is pressed or it is the sample data at the time that the graph is stopped.

Special case trend analysis graphs for PID tuning can be viewed for CH, DHW, and Lead Lag demands.

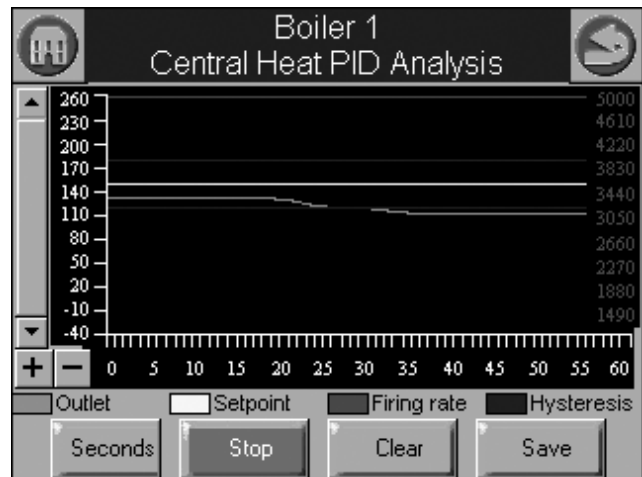

Fig. 111. PID Trend analysis page.

Data included in the PID analysis graph are:

- Sensor temperature (outlet for CH, DHW for DHW, and header for Lead Lag)

- Setpoint (for corresponding demand source)
- Burner firing rate
- Hysteresis on (for corresponding demand source)
- Hysteresis off (for corresponding demand source)

The Clear button is disabled for the PID analysis (doesn't apply to hysteresis).

The default sample rate is 15 sec periods (a tick mark on the X axis for every 15 second period, with minutes displayed every 4 tick marks).

Special case trend analysis graph for R7910/R7911 vessel heat exchange can be selected.

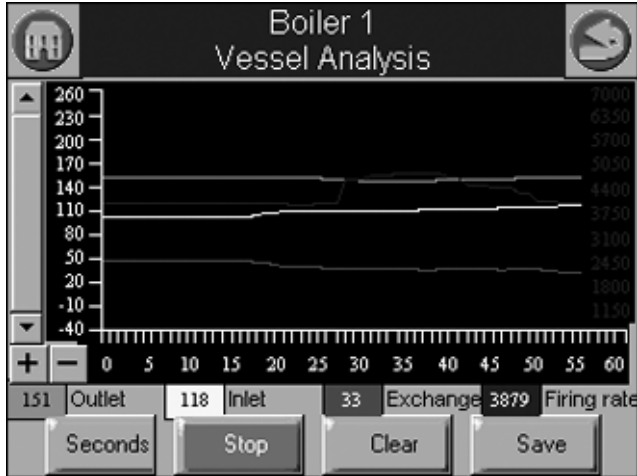

Fig. 112. Vessel analysis page.

Data included in the vessel analysis graph are:

- Outlet temperature
- Inlet temperature
- Heat exchange (outlet – inlet)
- Burner firing rate

Automatic sampling of trend data takes place when the trend analysis report is displayed. No user intervention is necessary to invoke sampling.

NOTE: Sample data is collected and stored in the S7999B. The R7910 or R7911 don't collect any historical data for trending purposes. For this reason any S7999B reset causes all R7910 or R7911 sampling to start over with no data.

Trend analysis of the following data from each R7910/R7911 is possible:

Table 59. R7910/R7911 Trend Analysis Data.

Data	Comment
Demand source	CH, DHW, LL (Lead Lag), or FP (Frost Protection) Steam Sensor
Outlet temperature (R7910 only)	
Firing rate	% or RPM
Fan speed	PWM feedback
Flame signal strength	V
Inlet temperature (R7910 only)	If enabled
DHW temperature (R7910 only)	If enabled
Outdoor temperature	If enabled

Table 59. R7910/R7911 Trend Analysis Data. (Continued)

Data	Comment
Stack temperature	If enabled
Header temperature (R7910 only)	If enabled
CH setpoint	Actual CH setpoint based on time of day (TOD).
DHW setpoint (R7910 only)	Actual DHW setpoint based on TOD.
Central Heat Operation Analysis	
Domestic Hot Water Operation Analysis (R7910 only)	
Vessel Analysis	

## Trend Analysis Snapshot

The trend analysis snapshot file is stored in Comma Separated Value (CSV) format in the S7999B so it can be imported into a spreadsheet program such as Microsoft Excel.

The trend analysis snapshot file can be viewed in graph form on the S7999B. It is also accessible in an Ethernet FTP session with the S7999B. This FTP session can be used to export the trend analysis snapshot file from the S7999B.

## Diagnostics

Pressing the Diagnostics button permits some display hardware diagnostics (see Fig. 104). **Normally, these diagnostics are applicable only for factory testing purposes, but conditions may arise that warrant this testing.**

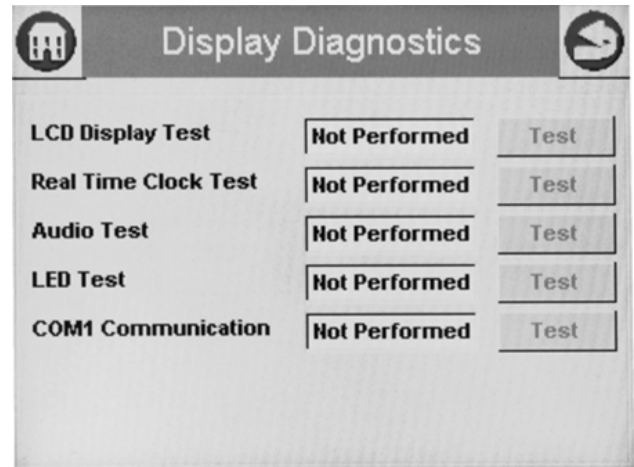

Fig. 113. Display diagnostics.

NOTE: COM 1 Communication test is a factory-only test. Performing this test when not connected to a factory test fixture will always yield a "Failed" result.

Each test is invoked by pressing the Test button next to the diagnostic. The results of the diagnostic test ("PASS" or "FAIL") display in the text box next to the Test button.

## Date and Time

Display time can be configured in the S7999B and S7999C OI Displays and applied to the R7910A or R7911. A date and time is entered by the user at the display and any data that is timestamped is marked with the current time and date in the display.

The Display clock is set by selecting the Date and Time button on the Advanced Setup page. A screen similar to the following figure (Fig. 114) displays.

**NOTE:** It's important that the time be set in the Display so correct timestamps are given to the R7910A or R7911 lockouts. The display's time and date need to be set should power be interrupted to the display.

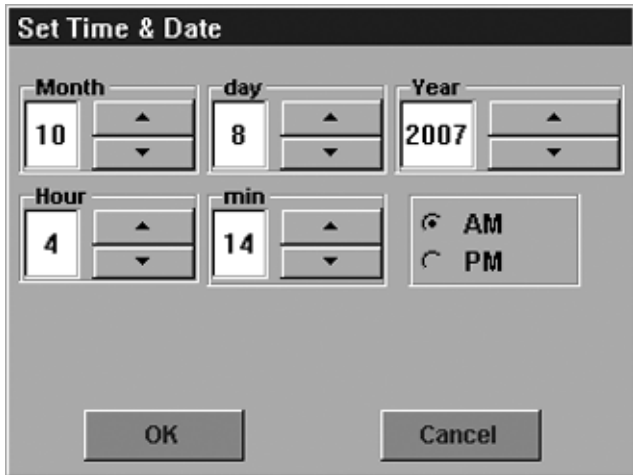

Fig. 114. Display Date and Time.

Edit the date and time and press the OK button to set the new settings. Press the Cancel button to exit without changing the time or date.

## Version

Pressing the Version button on the Advanced Setup page displays manufacturer and software version information (Fig. 115 and 116).

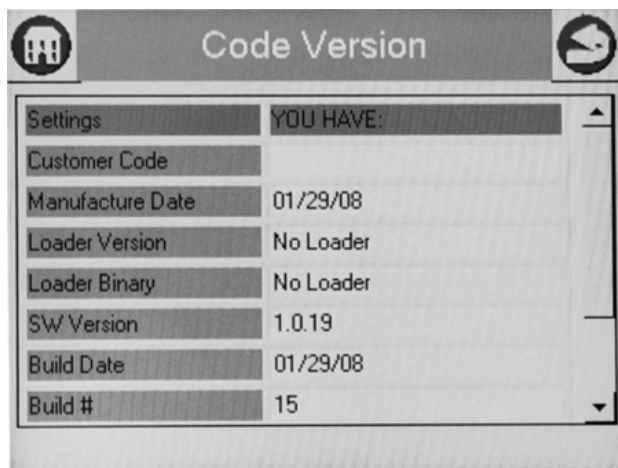

Fig. 115. Code version—top view.

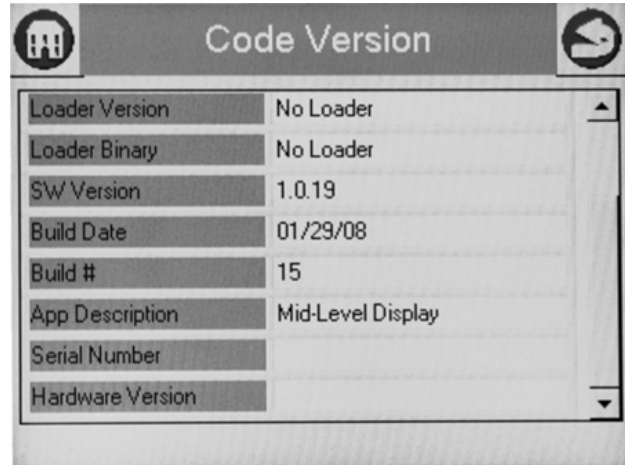

Fig. 116. Code Version—bottom view.

## User Preferences

The User Preferences button displays General options as well as those for for COM1 and COM2.

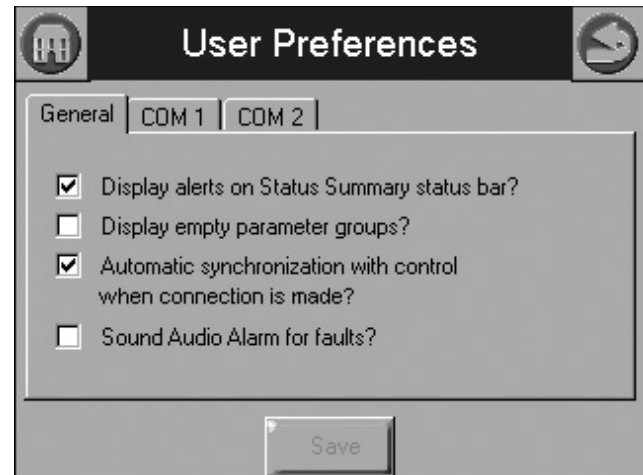

Fig. 117. General tab.

The General tab (see Fig. 117) contains the following settings:

- **Display alerts on Status Summary Bar?** This determines whether non-safety alerts will be shown on the summary bar of the home page.
- **Display empty parameter groups?** This cleans up the home page by hiding unused parameter groups.
- **Automatic synchronization with control when connections is made?** This allows automatic display of new control to update when the connection is identified instead of manually making the synchronization when the operator is ready.
- **Sound Audio Alarm for faults?** This uses the display speaker to sound an alarm on shutdown for SOLA faults.

The COM1 tab (see Fig. 118) contains the following setting:

- **Modbus address range 1-N:** Sets the Modbus address for the connected device (range is 1 to 250).

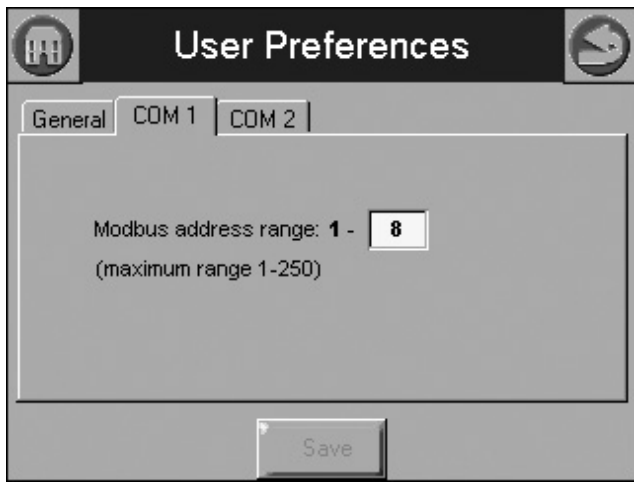

Fig. 118. COM 1 tab.

### S7999B Only

COM2 is a Modbus gateway for Building Automation System (BAS) networking.

Press the COM2 tab (see Fig. 119) to define settings:

- **Enable Modbus Gateway:** This box must be selected to enable the COM2 BAS interface.
- **Modbus Gateway Speed:** Select the baud rate (38400, 19, 200, or 9600 bps)
- **Modbus Gateway Timeout:** Defines how long the BAS will wait after sending a Modbus message before timing out and sending the next modbus message (currently non-functional; leave at 1.0)

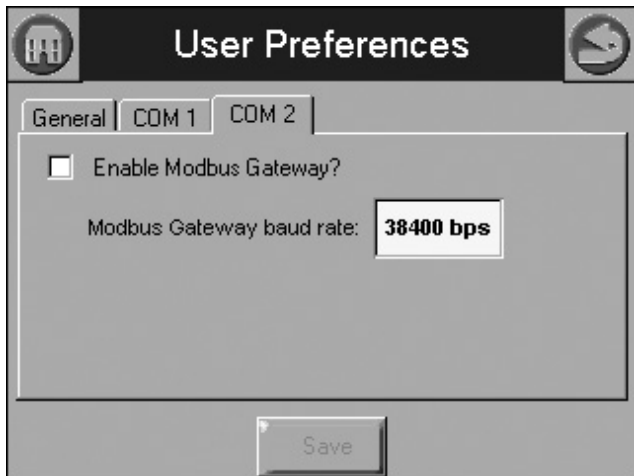

Fig. 119. COM 2 tab.

## Display Reset

The user can reset the display and force a power-up by pressing the Display Reset button. A pop-up dialog box confirming the reset request displays (Fig. 120) before the reset proceeds.

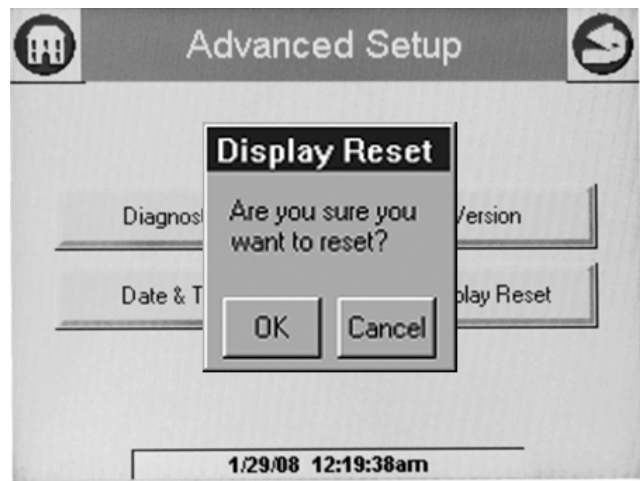

Fig. 120. Processor Reset.

When the Display is reset, the display will reboot and automatically seek out the Modbus™ device connected to it. When the search is complete, the display will return to the home page.

Table 60. Status Tables.

Name	Table #	Page #
CH	45	38
DHW	46	39
Burner Control	47	40
Demand and Modulation	48	41
Inlet High Limit	49	41
Fan	50	42
Pump	51	42
Flame Detection	52	42
Statistics	53	43
Stack Limit	54	43
Lead Lag Slave	55	43
Lead Lag Master	56	44

## Parameters

A complete list of configurable parameters is shown in Table 61.

Table 61. Configurable Parameters.

Parameter	Comment	Table #	Page #
Boiler Name	Name to identify boiler (up to 20 characters)	6	21
Installation	Notes regarding installation (up to 20 characters)		
Installer password	Change installer password setting		
OEM password	Change OEM password setting		
Factory Data	OEM name to associate with boiler (up to 20 characters)		

**Table 61. Configurable Parameters. (Continued)**

Parameter	Comment	Table #	Page #
CH enable	Disable or Enable Central Heating Loop	8	21
CH demand switch	Sensor for Central Heat demand: Sensor only Sensor & STAT terminal Sensor & Remote Stat LCI & Sensor		
CH Outdoor reset	Enabled Disabled		
CH has priority over Lead Lag	Yes, No, Cancel		
CH Setpoint source	Local S2 (J8-6) 4-20mA		
CH Setpoint	Setpoint for normal Central Heat modulation: -40 °F to 266 °F (-40 °C to 130 °C)		
CH time of day setpoint	Setpoint when Time Of Day switch is on. -40 °F to 266 °F (-40 °C to 130 °C)		
CH off hysteresis	Differential above setpoint when boiler is turned off. -40 °F to 266 °F (-40 °C to 130 °C)		
CH on hysteresis	Differential from setpoint when boiler is turned on. -40 °F to 266 °F (-40 °C to 130 °C)		
4 mA water temperature	-40 °F to 266 °F (-40 °C to 130 °C)		
20 mA water temperature	-40 °F to 266 °F (-40 °C to 130 °C)		
Modulation sensor	Outlet sensor, Inlet sensor, S5 (J8-11)		
Modulation Rate Sensor	Local		
CH P-gain	Time between hysteresis step changes: 0-400		
CH I-gain	Time between hysteresis step changes: 0-400		
CH D-gain	Time between hysteresis step changes: 0-400		
Hysteresis step time	Time between hysteresis step changes: 0-600 seconds (0=Disable hysteresis stepping)		

**Table 61. Configurable Parameters. (Continued)**

Parameter	Comment	Table #	Page #		
Steam enable	Disable/enable steam feature	9	22		
Steam demand source	Sensor and LCI Sensor and Remote Stat Sensor and Stat Terminal Sensor Only				
Steam pressure setpoint	Setpoint for normal modulation Adjustable 0 to 15 or 0 to 150 (sensor dependant)				
Steam time of day setpoint	Setpoint when TOD switch on Adjustable 0 to 15 or 0 to 150 (sensor dependant)				
Minimum steam pressure	Establishes setpoint for the 4ma. input. Adjustable 0 to 15 or 0 to 150 (sensor dependant)				
Steam pressure off hysteresis	Differential below setpoint when boiler is turned off Adjustable 0 to 15 or 0 to 150 (sensor dependant)				
Steam pressure on hysteresis	Differential from setpoint when boiler is turned on. Adjustable 0 to 15 or 0 to 150 (sensor dependant)				
Steam hysteresis step time	Time between hysteresis changes 0 to 600 seconds (0=disable)				
Steam P Gain	Gain applied for the P portion of the PID equation 0-400				
Steam I Gain	Gain applied for the I portion of the PID Equation - 0-400				
Steam D Gain	Gain applied for the D portion of the PID equation 0-400				
Steam 4-20 ma remote control	uses 4-20ma remote control function to control either the setpoint or modulation for Steam Disable, setpoint, modulation				
CH maximum outdoor temperature	-40 °F to 266 °F (-40 °C to 130 °C)			10	22
CH minimum outdoor temperature	-40 °F to 266 °F (-40 °C to 130 °C)				
Low water temperature	-40 °F to 266 °F (-40 °C to 130 °C)				
Minimum water temperature	-40 °F to 266 °F (-40 °C to 130 °C)				
Maximum off point	-40 °F to 266 °F (-40 °C to 130 °C)				

**Table 61. Configurable Parameters. (Continued)**

Parameter	Comment	Table #	Page #
DHW enable	Disable or Enable Domestic Hot Water Loop	11	23
DHW demand switch	Sensor for Central Heat demand: DHW sensor only, DHW sensor & Remote Stat, DHW switch & inlet sensor, or DHW switch & outlet sensor		
DHW Priority source	Which system has priority: Disabled or Heat Demand		
DHW Priority method	Boost during priority time Drop after priority time		
DHW Modulation sensor	DHW Sensor Outlet Sensor Inlet Sensor Auto: DHW (S6) or Inlet Sensor Auto: DHW (S6) or Outlet Sensor		
DHW setpoint	-40 °F to 240 °F (-40 °C to 115 °C)		
DHW time of day setpoint	Setpoint when Time Of Day switch is on. -40 °F to 240 °F (-40 °C to 115 °C)		
DHW off hysteresis	Differential above setpoint when boiler is turned off. -40 °F to 240 °F (-40 °C to 115 °C)		
DHW on hysteresis	Differential from setpoint when boiler is turned on. 2 °F to 234 °F (-16 °C to 112 °C)		
DHW priority override time	___hour ___min ___sec		
DHW hysteresis step time	Time between hysteresis step changes: 0-600 seconds (0=Disable hysteresis stepping)		
DHW priority vs CH	Which system has priority: Central Heat over Domestic Hot Water, or Domestic Hot Water over Central Heat		
DHW priority vs LL	Which system has priority: Lead Lag over Domestic Hot Water, Domestic Hot Water over Lead Lag		
DHW P-gain	Time between hysteresis step changes: 0-400		
DHW I-gain	Time between hysteresis step changes: 0-400		
DHW D-gain	Time between hysteresis step changes: 0-400		
DHW storage enable	Enabled, Disabled	12	23
Storage time	___hour ___min ___sec		
Setpoint	-40 °F to 266 °F (-40 °C to 130 °C)		
Off hysteresis	-0 °F to 180 °F (-17 °C to 82 °C)		
On hysteresis	-0 °F to 180 °F (-17 °C to 82 °C)		

**Table 61. Configurable Parameters. (Continued)**

Parameter	Comment	Table #	Page #
Tap detect degrees	-0 °F to 180 °F (-17 °C to 82 °C)	13	23
Tap detect on recognition time	___hour ___min ___sec		
Tap detect on threshold	-0 °F to 180 °F (-17 °C to 82 °C)		
Tap detect minimum on time	___hour ___min ___sec		
Tap stop inlet-DHW degrees	-0 °F to 180 °F (-17 °C to 82 °C)		
Tap stop outlet-Inlet degrees	-0 °F to 180 °F (-17 °C to 82 °C)		
Plate preheat setpoint	-40 °F to 266 °F (-40 °C to 130 °C)		
Plate preheat on recognition time	___hour ___min ___sec		
Plate preheat on hysteresis	-0 °F to 180 °F (-17 °C to 82 °C)		
Plate preheat off hysteresis	-0 °F to 180 °F (-17 °C to 82 °C)		
Plate preheat detect on threshold	-0 °F to 180 °F (-17 °C to 82 °C)		
Plate preheat detect off threshold	-0 °F to 180 °F (-17 °C to 82 °C)		
Plate preheat minimum on time	___hour ___min ___sec		
Plate preheat delay after tap	___hour ___min ___sec		
Warm Weather Setpoint Enable	Enabled, disabled	14	24
Warm Weather Setpoint	-40 °F to 266 °F (-40 °C to 130 °C)		

**Table 61. Configurable Parameters. (Continued)**

Parameter	Comment	Table #	Page #
CH maximum modulation rate	RPM or %	15	25
DHW maximum modulation rate	RPM or %		
Minimum modulation rate	RPM or %		
CH forced rate time	0-600 seconds		
CH forced rate	RPM or %		
DHW forced rate time	0-600 seconds		
DHW forced rate	RPM or %		
CH slow start enable	Enabled Disabled		
DHW slow start enable	Enabled Disabled		
Slow start degrees	-40 °F to 266 °F (-40 °C to 130 °C)		
Slow start ramp	RPM /minute or %/minute 0-10/4-20 mA Output hysteresis		
0-10/4-20 mA Output hysteresis			
4-20 mA input hysteresis			
Pump control	Auto On		
Pump output	Pump A Pump B Pump C None		
Pump start delay	___hour ___min ___sec		
Overrun time	___hour ___min ___sec		
Boiler pump output	Pump A Pump B Pump C None		

**Table 61. Configurable Parameters. (Continued)**

Parameter	Comment	Table #	Page #
Auxiliary pump control	Auto On	17	26
Auxiliary pump is on when	CH pump is ON Slave command		
Auxiliary pump output	Pump A Pump B Pump C None		
Boiler pump control	Auto On		
Boiler pump output	Pump A Pump B Pump C None		
Boiler pump overrun time	0-600 seconds 0 = Not configured		
CH pump control	Auto On		
CH pump output	Pump A Pump B Pump C None		
CH pump overrun time	0-600 seconds 0 = Not configured		
System pump control	Auto On		
System pump output	Pump A Pump B Pump C None		
System pump overrun time	0-600 seconds 0 = Not configured		
Pump exercise time	0-600 seconds 0= Not configured		
Auxiliary pump cycles	0-999,999		
Boiler pump cycles	0-999,999		
Burner cycles	0-999,999		
Burner run time	0-999,999		
CH pump cycles	0-999,999		
DHW pump cycles	0-999,999		
System pump cycles	0-999,999		
Auxiliary 2 pump cycles	0-999,999		



Table 61. Configurable Parameters. (Continued)

Parameter	Comment	Table #	Page #		
DHW high limit	Enabled Disabled	19	27		
DHW high limit response	Suspend DHW Recycle & hold Lockout				
DHW high limit setpoint	-40 °F to 266 °F (-40 °C to 130 °C)				
Outlet high limit response	Recycle & hold Lockout				
Outlet high limit setpoint	-40 °F to 266 °F (-40 °C to 130 °C)				
Stack limit	Enabled Disabled	20	28		
Stack limit delay	0-600 seconds				
Stack limit response	Lockout Recycle & delay				
Stack limit setpoint	-40 °F to 266 °F (-40 °C to 130 °C)				
Delta T enable	Enabled Disabled			21	28
Delta T degrees	-40 °F to 266 °F (-40 °C to 130 °C)				
Delta T delay	0-600 seconds				
Delta T response	Recycle & delay Lockout				
Delta T retry limit					
Delta T rate limit enable	Enabled Disabled				
Delta T inverse limit time	___hour ___min ___sec				
Delta T inverse limit response	Recycle & delay Recycle & delay with retry limit Lockout				
Outlet T-rise enable	Enabled Disabled	22	29		
Heat exchanger T-rise enable	Enabled Disabled				
T-rise degrees	0 °F to 234 °F (-17 °C to 112 °C)				
T-rise response	Recycle & delay Recycle & delay with retry limit Lockout				
T-rise retry limit	0 to 100				
T-rise delay	___hour ___min ___sec				

Table 61. Configurable Parameters. (Continued)

Parameter	Comment	Table #	Page #
Heat exchanger high limit enable	Enabled Disabled	23	29
Heat exchanger high limit setpoint	-40 °F to 266 °F (-40 °C to 130 °C)		
Heat exchanger high limit response	Recycle & delay Recycle & delay with retry limit Lockout		
Heat exchanger retry limit	0 to 100		
Heat exchanger high limit delay	___hour ___min ___sec		
CH anticondensation enable	Enabled Disabled	24	29
CH anticondensation pump	Normal (no change) CH pump forced off		
CH anticondensation setpoint	-40 °F to 266 °F (-40 °C to 130 °C)		
DHW anticondensation enable	Enabled Disabled		
DHW anticondensation pump	Normal (no change) DHW pump forced off		
DHW anticondensation setpoint	-40 °F to 266 °F (-40 °C to 130 °C)		
Anticondensation Priority	Anticondensation is more important than (check those that apply): Stack limit Delta T limit Slow start Forced rate Outlet high limit		

**Table 61. Configurable Parameters. (Continued)**

Parameter	Comment	Table #	Page #
CH frost protection enable	Enabled Disabled	25	30
DHW frost protection enable	Enabled Disabled		
Lead Lag frost protection enable	Enabled Disabled		
Outdoor frost protection setpoint	-40 °F to 266 °F (-40 °C to 130 °C) (applicable for CH only)		
Lead Lag frost protection rate	___%		
CH pump frost overrun time	___hour ___min ___sec		
DHW pump frost overrun time	___hour ___min ___sec		
Annunciation enable	Enabled Disabled	26	30
Annunciator (1–8) location	01 - Annunciator 1 02 - Annunciator 2 03 - Annunciator 3 04 - Annunciator 4 05 - Annunciator 5 06 - Annunciator 6 07 - Annunciator 7 08 - Annunciator 8 PII - Pre-Ignition ILK LCI - Load Control Input ILK - Interlock		
Annunciator (1–8) short name	Up to 3 characters		
Annunciator (1–8) name	Up to 20 characters		

**Table 61. Configurable Parameters. (Continued)**

Parameter	Comment	Table #	Page #
PII enable	Enabled Disabled	27	31
LCI enable	Enabled Disabled		
Interrupted air switch (IAS) enable	Enable during purge and ignition Disabled Enable during purge		
Interlock (ILK) start check enable	No ILK check ILK check		
ILK/IAS open response	Recycle Lockout		
ILK bounce detection enable	Enabled Disabled		
Purge rate proving	Fan Speed High Fire Switch None		
Lightoff rate proving	Fan Speed Low Fire Switch None		
Prepurge rate	RPM or %	28	31
Prepurge time	0-600 seconds 0 = Not configured		
Run stabilization time	0-600 seconds 0 = Not configured		
Standby Rate	RPM or %		
Postpurge rate	RPM or %		
Postpurge time	0-600 seconds 0 = Not configured		
Forced recycle interval time	___hour ___min ___sec		

Table 61. Configurable Parameters. (Continued)

Parameter	Comment	Table #	Page #
Pilot test hold	On Off	29	32
Ignition source	Hot Surface Igniter External ignition Internal ignition		
Pilot type	Direct burner constant ignition Direct burner pulsed ignition Intermittent Interrupted		
Lightoff rate	RPM or %		
Preignition time	0-600 seconds 0 = Not configured		
Pilot Flame Establishing Period	15 secs 10 secs 4 secs		
Igniter on during	1st half of PFEP Pilot Flame Establishing Period		
Main Flame Establishing Period	15 secs 10 secs 5 secs		
Flame Threshold	$\mu$ A/V		
Ignite failure response	Lockout Recycle Recycle & hold Recycle & lockout		
Ignite failure delay	0-600 seconds 0 = Not configured		
Ignite failure retries	1, 3, or 5		
MFEP flame failure response	Recycle Lockout		
Run flame failure response	Recycle Lockout		
Fan speed error response	Recycle Lockout		

Table 61. Configurable Parameters. (Continued)

Parameter	Comment	Table #	Page #		
Flame sensor type	Flame rod UV power tube UV power tube with spark interference None	31	35		
Modulation output	4-20mA 0-10V Fan PWM*				
Blower/HSI	Blower Hot surface ignition				
Temperature units	Fahrenheit Celsius				
Anti short-cycle time	0-600 seconds 0 = Not configured				
Alarm silence time	0-600 minutes 0 = Not configured				
Power up with Lockout	Clear lockout Do NOT clear lockout				
STAT & EnviraCOM remote stat	Enabled Disabled				
Flame sensor type	Flame rod UV			32	35
Modulation output	4-20ma 0-10V Fan PWM				
Blower/HSI	Blower Hot surface ignitor				
Temperature units	Fahrenheit Celsius				
Anti short cycle time	0-600 minutes				
Alarm silence time	0-600 minutes				
Power up with lockout	Clear lockout Do NOT clear lockout				
Inlet connector type	0-15 psi 0-150 psi UNCONFIGURED				
Stack connector type	10k NTC dual safety 10k NTC single non-safety 12k NTC single non-safety UNCONFIGURED				
Header	4-20ma UNCONFIGURED				

**Table 61. Configurable Parameters. (Continued)**

Parameter	Comment	Table #	Page #
Absolute maximum fan speed	RPM	33	35
Absolute minimum fan speed	RPM		
Fan gain down	0-100		
Fan gain up	0-100		
Minimum duty cycle	1-100%		
Pulses per revolution	1-10		
PWM frequency	1000 2000 3000 4000		
Slow down ramp	0-12000 RPM/sec		
Speed up ramp	0-12000 RPM/sec		
Slave enable	Slave ModBUS slave Disabled		
Slave mode	Use first Use last Equalize run time		
Base load rate	0-6000 rpm		
Slave sequence order	0-8		
Demand to firing delay	___hour ___min ___sec		
Fan rate during off cycle	0-12000 rpm		
ModBus port	MB1 MB2 No port		
ModBus address	0-250		
Master enable	Enabled Disabled		
CH setpoint	-40 °F to 266 °F (-40 °C to 130 °C)	35	36
CH time of day setpoint	-40 °F to 266 °F (-40 °C to 130 °C)		
ModBus port	MB1 MB2 No port		
ModBus address	0-250		

**Table 61. Configurable Parameters. (Continued)**

Parameter	Comment	Table #	Page #
Modulation backup sensor	Lead outlet sensor Slave outlet sensor average Disabled	36	36
Off hysteresis	0 °F to 234 °F (-17 °C to 112 °C)		
On hysteresis	0 °F to 234 °F (-17 °C to 112 °C)		
Hysteresis step time	___ Hour ___ Minute ___ Second		
P gain	0 - 400		
I gain	0 - 400		
D gain	0 - 400		
Demand switch	Stat Remote Stat ModBus Stat Disabled	37	37
Setpoint source	Local ModBus 4-20 ma		
Setpoint	-40 °F to 266 °F (-40 °C to 130 °C)		
Time of day setpoint	-40 °F to 266 °F (-40 °C to 130 °C)		
4 ma water temperature	-40 °F to 266 °F (-40 °C to 130 °C)		
20 ma water temperature	-40 °F to 266 °F (-40 °C to 130 °C)	38	37
Outdoor reset	Enabled Disabled		
Priority source	DHW heat demand Disabled		
Priority method	Boost during priority time Drop after priority time	39	37
DHW priority override time	___ Hour ___ Minute ___ Second		
Enable	Enabled Disabled	40	37
Outdoor setpoint	-40 °F to 266 °F (-40 °C to 130 °C)		
Frost protection rate	___ %		
Enable	Enabled Disabled	40	37
Setpoint	-40 °F to 266 °F (-40 °C to 130 °C)		

**Table 61. Configurable Parameters. (Continued)**

Parameter	Comment	Table #	Page #
Lead selection method	Sequence order Measured run time	41	37
Lag selection method	Sequence order Measured run time		
Lead rotation time	___ day ___ hour ___ min		
Force lead rotation time	___ day ___ hour ___ min		
Base load common	? %	42	37
Method	Error threshold Firing rate threshold Disabled	43	37
Detection time	___ Hour ___ Minute ___ Second		
Error threshold	0 °F to 234 °F (-17 °C to 112 °C)		
Rate offset	± _____ %		
Interstage delay	___ Hour ___ Minute ___ Second		

**Table 61. Configurable Parameters. (Continued)**

Parameter	Comment	Table #	Page #
Method	Error threshold Firing rate threshold Disabled	44	37
Detection time	___ Hour ___ Minute ___ Second		
Error threshold	0 °F to 234 °F (-17 °C to 112 °C)		
Rate offset	± _____ %		
Interstage delay	___ Hour ___ Minute ___ Second		

**Table 62. Other Tables.**

Name	Table #	Page #
4-pin Connector Terminals	2	10
Lockout History	3	16
Alert Log	4	16
Digital I/O Data	57	45
Analog I/O Data	58	45



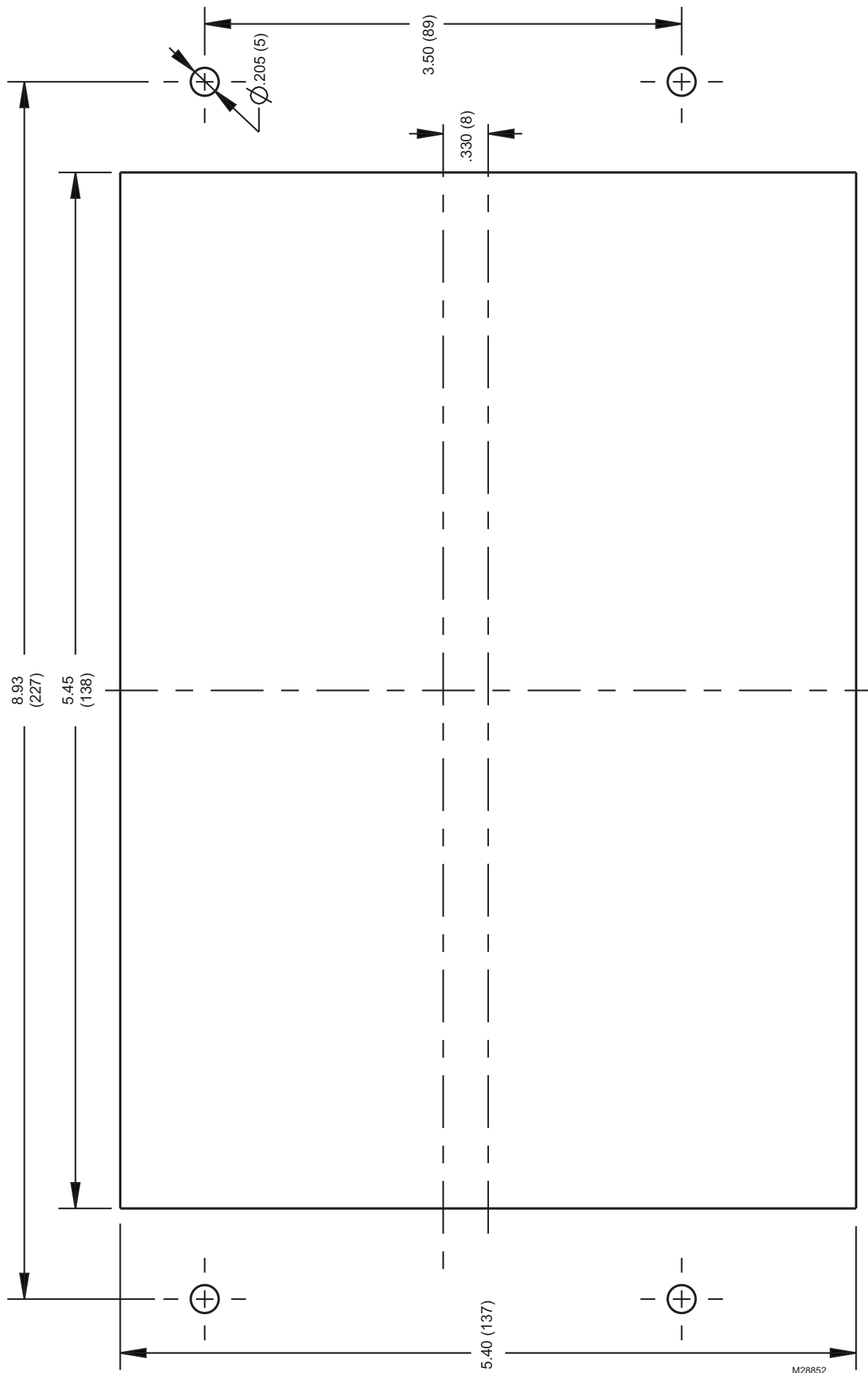

M28852

Fig. 121. S7999C front-mount template.





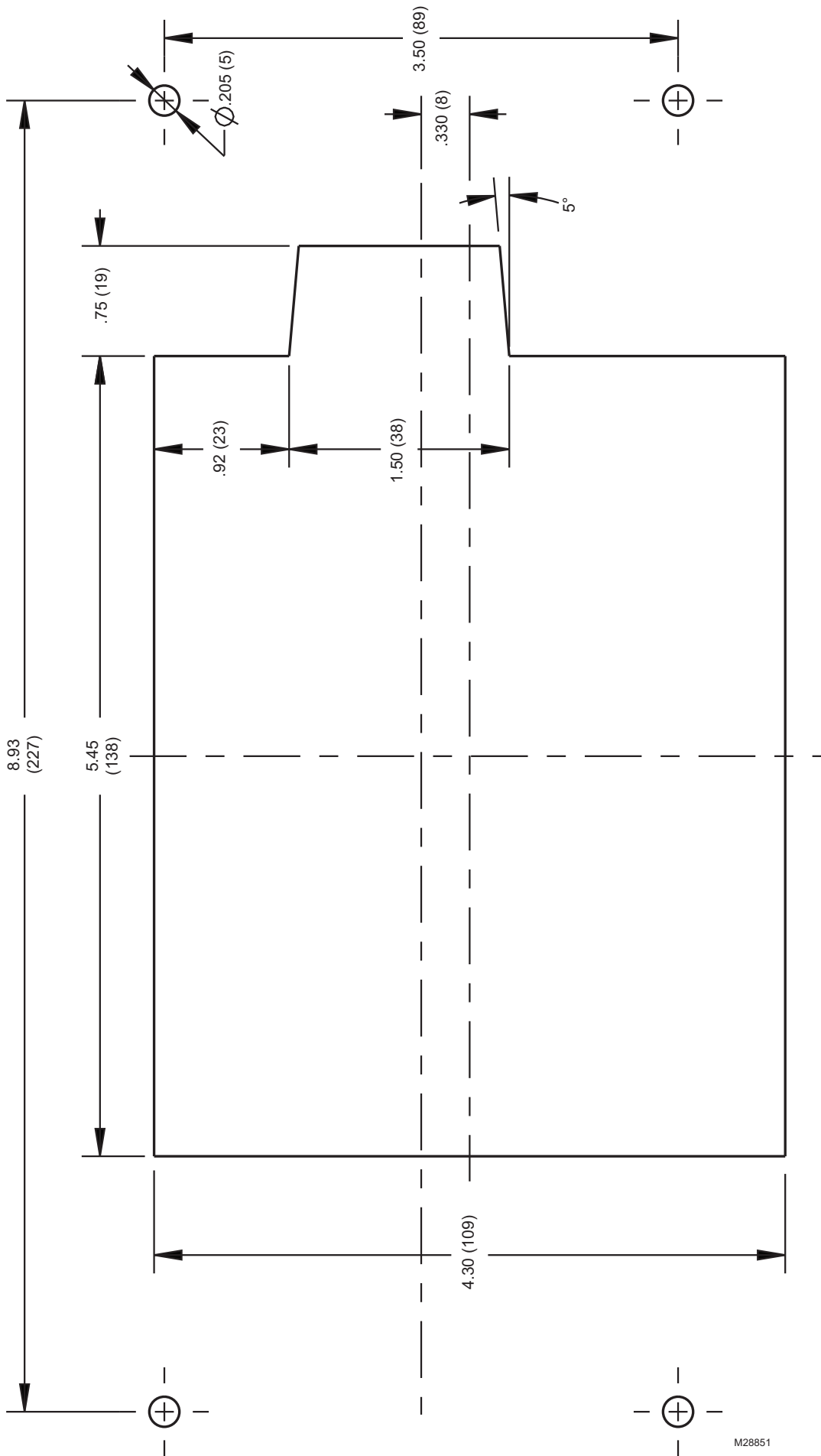

M28851

Fig. 122. S7999C rear-mount template.





**Automation and Control Solutions**

Honeywell International Inc.  
1985 Douglas Drive North  
Golden Valley, MN 55422

Honeywell Limited-Honeywell Limitée  
35 Dynamic Drive  
Toronto, Ontario M1V 4Z9  
[customer.honeywell.com](http://customer.honeywell.com)

® U.S. Registered Trademark  
© 2010 Honeywell International Inc.  
65-0303—05 M.S. Rev. 04-10  
Printed in U.S.A.

**Honeywell**

## Free Manuals Download Website

<http://myh66.com>

<http://usermanuals.us>

<http://www.somanuals.com>

<http://www.4manuals.cc>

<http://www.manual-lib.com>

<http://www.404manual.com>

<http://www.luxmanual.com>

<http://aubethermostatmanual.com>

Golf course search by state

<http://golfingnear.com>

Email search by domain

<http://emailbydomain.com>

Auto manuals search

<http://auto.somanuals.com>

TV manuals search

<http://tv.somanuals.com>