

# Honeywell

---

## Portable Air Conditioner

### OWNER'S MANUAL

Read these instructions before use

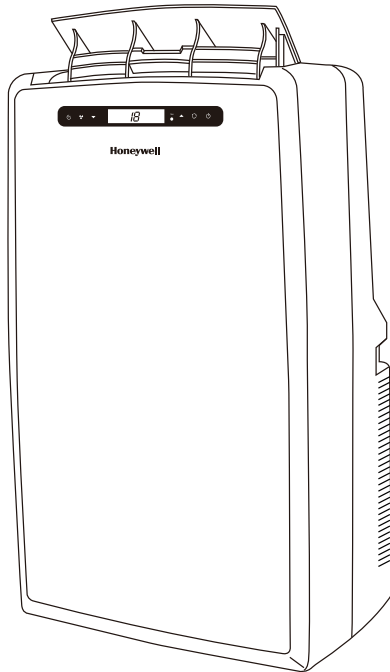

**Model: MM14CCS**

Voltage rating: 120V~60Hz

Power rating : 1400W

Customer Support : 1-800-474-21477

---

For product inquiries or support : [www.honeywellportableac.com](http://www.honeywellportableac.com)

Download from [www.Somanuals.com](http://www.Somanuals.com). All Manuals Search And Download.

Made in China

Read all instructions carefully before setting up and operating the unit. Please keep this instruction manual for future reference. This manual is designed to provide you with important information needed to setup, operate, maintain and troubleshoot your portable air conditioner. Failure to follow these instructions may damage and/or impair operation and void the warranty.

<b>SECTION</b>	<b>PAGE</b>
1. INDEX .....	1
2. THANK YOU.....	2
3. USER TIPS.....	3
4. SAFETY .....	4
5. PARTS DESCRIPTION.....	6
6. INSTALLATION.....	7
7. USE & OPERATION.....	10
8. CLEANING & MAINTENANCE.....	13
9. WATER DRAINAGE.....	14
10. TROUBLESHOOTING GUIDE.....	15
11. TECHNICAL SPECIFICATIONS.....	16
12. SERVICE AND WARRANTY .....	17

# THANK YOU

Congratulations on your purchase of this versatile Honeywell Portable Air Conditioner.

Honeywell Portable Air Conditioners are ideal for spot cooling. The compressor, condenser and evaporator are housed in a compact unit. The air is filtered, dehumidified and cooled while a flexible air outlet hose sends heat outside. The air conditioner includes a window venting kit. No permanent installation is needed so the unit is easy to move from room to room and offers a truly flexible air conditioning solution.

Auto Evaporation System - The unit automatically evaporates the condensate through the air outlet hose. No need to empty the drainage tank except in very high humidity conditions.

Please read the instructions carefully.

To ensure optimal efficiency of the product, we recommend keeping doors and windows closed when it is used as an air conditioner or dehumidifier.

If the product is being used with the fan function only, please position the unit near an open window so that outside air is drawn into the unit, the air circulates in the room and then exits via the door.

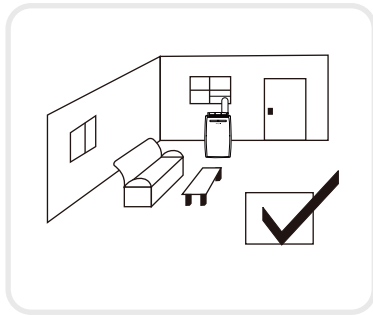

Cooling, Dehumidifying function

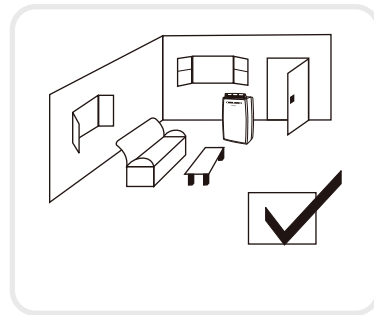

Fan function

**Important : After transporting the unit, place it UPRIGHT for 20 min. before use to allow the refrigerant to stabilize.**

- Check that the unit is complete with all accessories as outlined in this instruction manual.
- Follow installation instructions to set up your unit.
- Plug the unit into a properly grounded circuit.

# SAFETY

## READ AND SAVE THESE INSTRUCTIONS

Improper handling can cause serious damage to the appliance.



### **WARNING**

1. DO NOT operate the unit with a damaged plug or loose socket point. If the power cord is damaged, it must be replaced by the manufacturer or an authorized service agent.
2. DO NOT cover the air intake and exhaust when in use.
3. This appliance is not intended for use by children. Children should be supervised and should not play on or around the appliance.
4. DO NOT place objects on or sit on the unit.
5. Always turn off and unplug the unit when cleaning or servicing.

If service is needed contact an authorized service agent.

Unplug the unit when stored or not in use.

8. DO NOT run the power cord under carpeting and rugs.
9. Use caution to prevent tripping on cord.
10. DO NOT use in areas where gasoline, paint or other flammable goods are stored.
11. Basic safety precautions should always be followed when using electrical appliances.

# PARTS DESCRIPTION

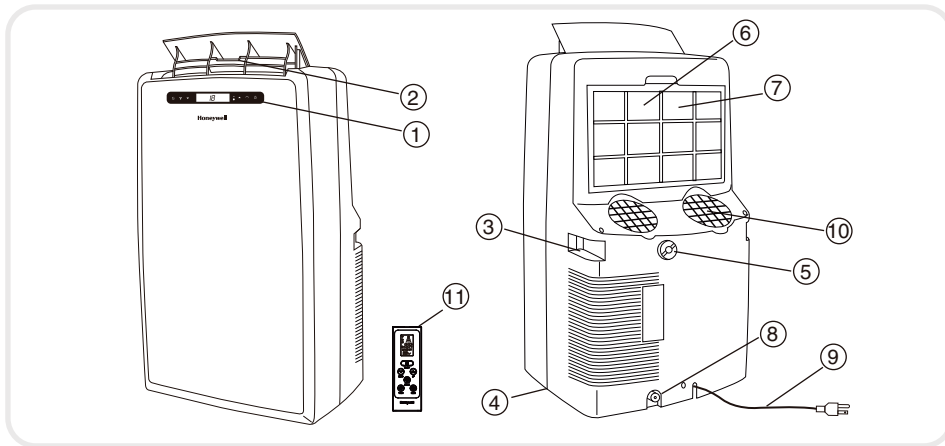

- |   |   |
|---|---|
| 1. Control Panel ( Incl. Signal Receptor) | 7. Back grill                               |
| 2. Air Outlet                             | 8. Water drain Cap (Air Conditioning Mode)  |
| 3. Handle                                 | 9. Power Supply Cord                        |
| 4. Caster                                 | 10. Hose Connector                          |
| 5. Water Drain Cap (De-humidifier mode)   | 11. Remote Control (Batteries not included) |
| 6. Air Filter                             |   |

## Installation Kit :

- |                                      |          |
|--------------------------------------|----------|
| 1. Window Bracket Kit.....           | 1 Set    |
| 2. Window Bracket Panel Adapter..... | 1 Piece  |
| 3. Plastic Screws.....               | 2 Pieces |
| 4. Hose Connector.....               | 1 Piece  |
| 5. Plastic Hose.....                 | 1 Piece  |

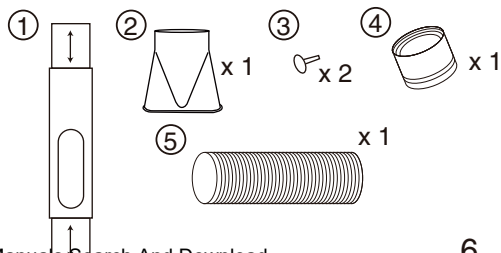

- ① Install the plastic hose with window bracket adapter and hose connector on both sides. Ensure proper fit on both ends.

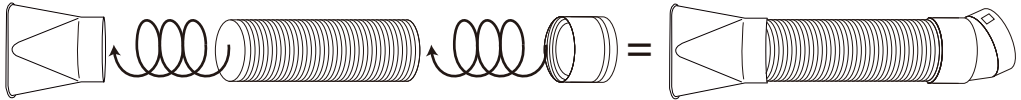

- ② Adjust the window bracket as per width or height of your window and insert a plastic screw to fix at the desired position.

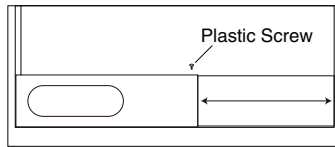

Note : Do not install the window bracket to your window. This step is required only to adjust it to the size of your window. The bracket should be removed from the window after the size is adjusted.

- ③ Connect the plastic hose to the hose connector on back of the unit.

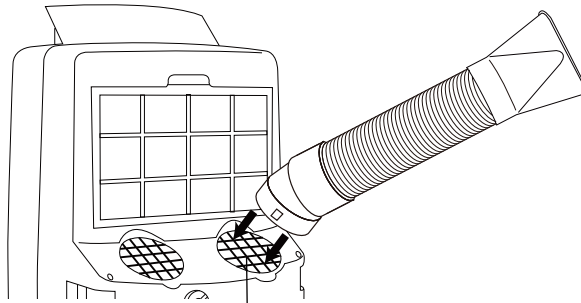

Push-in Rotate



# INSTALLATION

- ④ Connect the window bracket to the opposite end of the plastic hose. Ensure that connections are tight and installed properly.

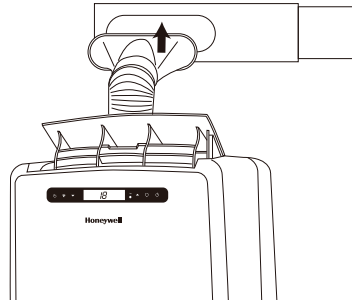

- ⑤ Connect the window bracket to the window.

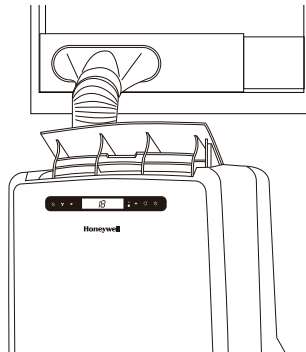

The Portable Air Conditioner is now ready to use.

## NOTE:

1. The supplied exhaust hose can be extended from 12 inches (1 feet) to 47 inches (3.9 feet).
2. Do not bend (to the extent shown below) the exhaust hose.  
A bent hose will block exhaust air and cause the unit to malfunction or shut-off.

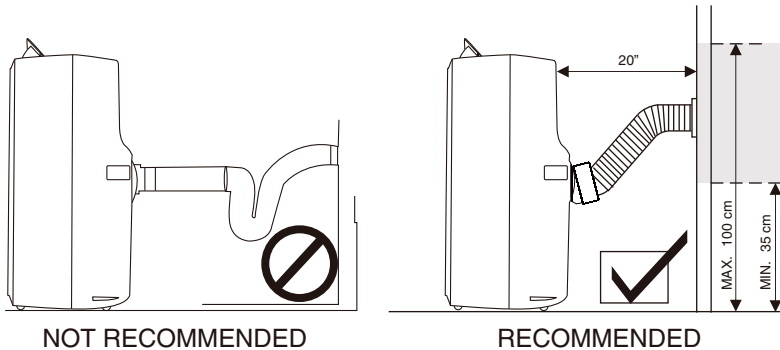









## Warning:

- The length of the exhaust hose is designed according to the product specifications. Do not replace or lengthen it with any other pipe or hose as this could cause the unit to malfunction.
- Make sure the back of the unit is at least 20 inches away from a wall. Do not place the unit in front of curtains or drapes as this could obstruct the airflow.



Indication symbols on LCD panel:

- |  |  |  |
|--|--|--|
|  Cooling Mode    |  High Fan Speed   |  88°F 88°C Display set temperature in Fahrenheit or Celsius                   |
|  Dehumidify Mode |  Medium Fan Speed |  Error – The machine will stop running  |
|  Fan Mode        |  Low Fan Speed    |  88h Display timer setting to automatically turn on/off between 1 to 24 hours |

**Power Control**

The power control turns the unit on and off.

**Mode Control****The Mode Control has 3 settings:****• Cool • Dehumidify • Fan**

The settings are adjusted with Mode Control button. A light will indicate which setting is currently being used.

**• Cooling Mode ❄️**

When cooling mode is selected, the indicator light will shine. During the cooling mode the air is cooled and hot air is exhausted to the outside through the exhaust tube.

Adjust fan speed and air temperature to suit your desired comfort level. Temperature setting range is 16°C ~ 32°C.

**Note : The air exchange hoses must vent outside the room when using cool mode.**

**• Dehumidify Mode 🌀**

When dehumidify mode is selected, the indicator light will shine. Air is dehumidified as it passes through the unit, without being in full cooling mode. If room temperature is higher than 25 degree Celsius, fan speed can be adjusted; otherwise fan speed is fixed to " LOW " .

**Note : If the unit will be used mainly as dehumidifier, do not connect the exhaust hose and let the warm air return in the room. Continuous drainage is then necessary and more efficient.**

**• Fan Mode 🌀**

When fan mode is selected the indicator light will shine. Air is circulated throughout the room with no cooling.

**After switching the air conditioner off, you must wait 3 minutes before switching it back on again.**

**Note: unit does not need to be vented in Fan mode.**

**Fan Speed Control**

The Fan Speed Control has 3 settings: High, Medium, and Low.

**Timer****Auto turn off :**

With machine in running mode, press timer button to select number of hours you would like the unit to run in air conditioning mode until it automatically shuts off.

**Auto turn on :**

With machine in stand by mode, press timer button to select number of hours until you would like the unit to automatically start running in air conditioning mode.

**Timer / Temp set controls**

- Used for adjusting the timer and thermostat.
- The default display is room temperature.
- In cooling mode, when "▲" or "▼" button is pressed, the set temperature is displayed and may be adjusted. After 10 seconds the display will revert back to room temperature. Temperature is only adjustable in cool mode. The time is adjustable between 1~24 hours.

Note : By pressing both "▲" / "▼" set buttons at the same time, the display will toggle between Celsius and Fahrenheit.

**Warning Light**

Condensed water may accumulate in the unit. If the internal tank becomes full, the Power Light will flash and the unit will not operate until the unit has been drained.

# USE & OPERATION

## REMOTE CONTROL (batteries not included)

The functions work the same as your portable air conditioner's touch controls. All key functions can be accessed from the remote control.

### Notes:

- Do not drop the remote control.
- Do not place the remote control in a location exposed to direct sunlight.
- The remote control should be placed about 1 meter or more away from TV, or any electrical appliances.

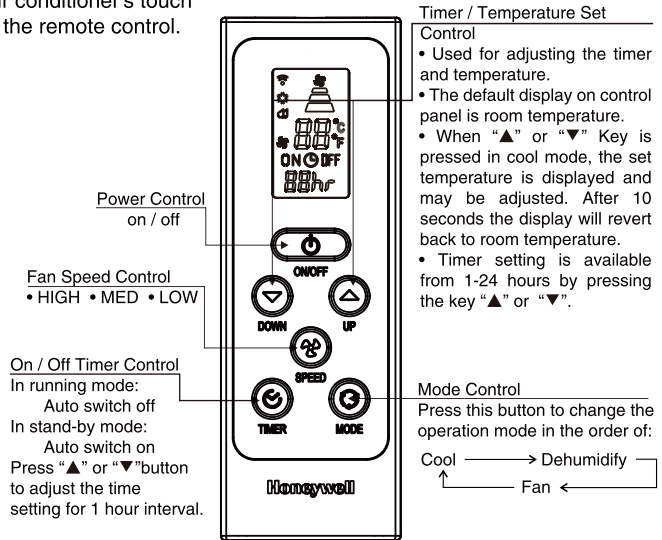

**Battery replacement :** Remove the cover on the back of the remote control and insert the batteries with the ( + ) and ( - ) poles pointing in the proper direction.

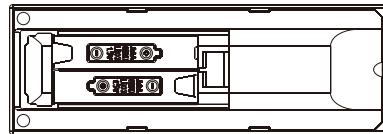

### CAUTION :

Use only AAA or IEC R03 1.5V batteries.

Remove the batteries if the remote control is not used for a month or longer.

Do not attempt to recharge the supplied batteries.

All batteries should be replaced at the same time, do not mix old battery .

Do not dispose of the batteries in a fire as they may explode.

## **Appliance Maintenance:**

1. Turn off the appliance before disconnecting the power supply.
2. Always clean with a soft dry cloth.

## **Air Filter Maintenance:**

The air filter should be cleaned after every two weeks of use.  
Clean it as follows:

1. Turn off the appliance and remove the air filters.
2. Wash it with a solution of detergent in lukewarm water. After cleaning, dry in a shaded and cool place, then reinstall.

## **Maintenance After Use:**

1. If the appliance will not be used for a long time, be sure to drain the left-over water condensation by removing the water drain cap (Air Conditioner mode) located on the lower backside of the air conditioner. Use a shallow pan to collect the water while draining.
2. To dry excess moisture, run the unit in fan mode for 30 minutes before storing.
3. Clean and reinstall air filter.
4. Remove air hose and window bracket and store with the portable air conditioner.

# WATER DRAINAGE

Your machine is equipped with two drain plugs on the backside, De-humidifier mode and Air Conditioning mode. Water will need to be drained only in two conditions :

- De-humidifier mode
- Air Conditioning mode, when ambient humidity is very high.

Whenever there is excess water accumulation inside the unit, and it needs to be drained. The machine will stop running and will show an error message. This error message indicates that the water needs to be drained out using below given procedures :

## Water Drain (Air Conditioning Mode)

- Your machine is equipped with an Auto-Evaporation System, due to which no water needs to be drained in Air Conditioning Mode.
- However in high humidity areas, you may need to drain water from this drain plug.
- In order to drain water from this drain plug, please open the cap and place a water tray under the drain plug.
- Water will drain out automatically and will be collected in this tray.

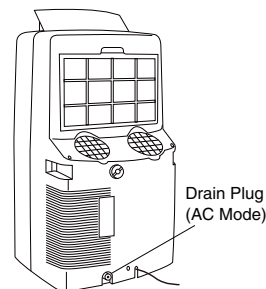

## Continuous Water Drain (De-humidifier Mode)

- When the unit is running in de-humidifier mode you have to keep emptying the water stored inside the water tank.
- The unit has a threaded drain connection located on the back side (refer to fig.).
- Remove the drain plug, install the drain connector(5/8" universal female mender) with 3/4" hose(locally purchased).
- Once a hose is attached the water drains into the hose. The hose can then be directed away from the dehumidifier into a floor drain.

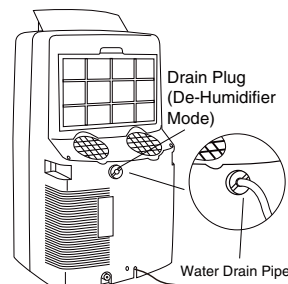

The following troubleshooting guide addresses the most common problems. If problems persist, call customer service. Unplug and disconnect the appliance from the power source before attempting to troubleshoot.

<b>Problem</b>	<b>Possible Cause</b>	<b>Solution</b>
The air conditioning unit does not start	<ul style="list-style-type: none"> <li>• No electricity.</li> <li>• Batteries in the remote control need to be replaced</li> <li>• The power cord is not properly plugged in.</li> <li>• The safety GFI plug has tripped.</li> </ul>	<ul style="list-style-type: none"> <li>• Check for power.</li> <li>• Change remote control batteries.</li> <li>• Remove and reconnect the power cord.</li> <li>• Reset the safety GFI plug, if problem persists contact our customer support.</li> </ul>
Runs a short while only	<ul style="list-style-type: none"> <li>• The thermostat temperature setting is too close to room temperature.</li> <li>• Air outlet is blocked.</li> <li>• There are tight bends in the air exhaust hose.</li> </ul>	<ul style="list-style-type: none"> <li>• Lower the set temperature.</li> <li>• Make sure the exhaust hose is properly connected.</li> <li>• Connect exhaust hose as per instructions on page 9.</li> </ul>
Runs but no cooling	<ul style="list-style-type: none"> <li>• A door or window is open.</li> <li>• The air filter is dirty.</li> <li>• The exhaust hose is detached.</li> <li>• Temperature setting is too high.</li> <li>• Air outlet or intake is blocked.</li> </ul>	<ul style="list-style-type: none"> <li>• Make sure the windows and door are closed.</li> <li>• Clean the air filter</li> <li>• Reinstall exhaust hose properly (Refer page 9, Installation)</li> <li>• Reduce temperature setting on control panel.</li> <li>• Remove blockage.</li> </ul>
Will not run and water full indicator light is ON	<ul style="list-style-type: none"> <li>• Excess water condensation inside the tank.</li> </ul>	<ul style="list-style-type: none"> <li>• Drain the water through the drain plug (Refer page 14, Water Condensation Drainage).</li> </ul>



# TECHNICAL SPECIFICATIONS

Results may vary according to application in different environments. Result will vary on practical operation.

<b>Description of Product</b>	<b>Portable Air Conditioner</b>
Model	MM14CCS
Voltage/Frequency	120 V~ 60 Hz
Power	1400W
Cooling Capacity	14000 BTU
Dehumidifying capacity	95 pints/24 hours
Refrigerant	R-410A
Timer	24 hour ( ON / OFF)
Dimensions (W) x (D) x (H) (mm)	401 X 506 X 864mm
Weight (Kg)	42.5 Kg

Waste electrical products should be properly disposed.  
Please recycle where facilities exist. Check with your local authority  
or retailer for recycling.



## 5-YEAR LIMITED WARRANTY

**Read all the instructions before attempting to use this product.**

1 year parts and labor, 5 years on all parts of the sealed system, consisting of the compressor, evaporator, condenser and factory connected refrigerant tubing.

- A. This warranty does not apply to any damage resulting from commercial, abusive, unreasonable use or supplemental damage. Defects that are the result of normal wear and tear will not be considered manufacturing defects under this warranty.

JMA NORTH AMERICA LLC IS NOT LIABLE FOR INCIDENTAL OR CONSEQUENTIAL DAMAGES OF ANY NATURE. ANY IMPLIED WARRANTY OF MERCHANTABILITY OR FITNESS FOR A PARTICULAR PURPOSE ON THIS PRODUCT IS LIMITED IN DURATION TO THE DURATION OF THIS WARRANTY.

Some jurisdictions do not allow the exclusion or limitation of incidental or consequential damages or limitations on how long an applied warranty lasts, so the above limitations or exclusions may not apply to you. This warranty gives you specific legal rights, and you also may have other rights which vary from jurisdiction to jurisdiction. This warranty applies only to the original purchaser of this product from the original date of purchase.

- B. At its option, JMA NORTH AMERICA LLC will repair or replace this product if it is found to be defective in material or workmanship.
- C. This warranty does not cover damage resulting from any unauthorized attempts to repair or from any use not in accordance with the instruction manual.

# SERVICE AND WARRANTY

D. Please read the Instruction Manual carefully before setting up or using this product. If you believe this product to be suffering from a manufacturing fault, or if you have inquiries about this product, please contact our Customer Support:

## CUSTOMER SUPPORT

JMA North America LLC  
Ramsey, New Jersey, 07446.  
Phone : 1-800-474-2147  
Email : info@jmana.us

When contacting our Customer Support, please have the information below along with the proof of purchase. All warranty requests must be accompanied by a proof of purchase, which is a copy of the original receipt.

Model : .....  
Date of purchase: .....  
Purchased from : .....

Distributor:

**JMA North America LLC**

Ramsey New Jersey 07446

Customer Support: 1-800-474-2147

E-mail: [info@jmana.us](mailto:info@jmana.us)

[www.honeywellportableac.com](http://www.honeywellportableac.com)

MM14CCS\_IM\_Eng\_USA\_1

December 2012

© 2012 AirTek Int'l Corp. Ltd.

(JMATEK Int'l Group of Companies)

The Honeywell Trademark is used under license from  
Honeywell International Inc.

Honeywell International Inc. makes no representation or  
warranties with respect to this product.

# Honeywell

## Free Manuals Download Website

<http://myh66.com>

<http://usermanuals.us>

<http://www.somanuals.com>

<http://www.4manuals.cc>

<http://www.manual-lib.com>

<http://www.404manual.com>

<http://www.luxmanual.com>

<http://aubethermostatmanual.com>

Golf course search by state

<http://golfingnear.com>

Email search by domain

<http://emailbydomain.com>

Auto manuals search

<http://auto.somanuals.com>

TV manuals search

<http://tv.somanuals.com>