

ML4125, ML4135, ML8125, ML8135 Fast-Acting, Two-Position Actuators

FOR HEATING, VENTILATION AND
AIR-CONDITIONING APPLICATIONS

PRODUCT DATA



FEATURES

- Integral spring return.
- -40 to 130°F (-40 to 54°C) operating temperature range.
- No audible noise during holding.
- Electronic circuitry provides efficient operation while eliminating the need for limit switches.
- Ninety-five degree angle of rotation.
- Die-cast aluminum housing.
- Housing design allows flush mounting to damper.
- Integral junction box with three conduit openings eliminates need for separate wiring box.
- Direct mounting to 3/8 or 1/2 in. round or square shaft.

ML4125, ML8125

- 100 lb-in. (11.3 N•m) minimum driving torque.
- 25 to 40 second drive timing (load dependant).
- Models available for 24, 120, and 230 Vac.

ML4135, ML8135

- 40 lb-in. (4.5 N•m) minimum driving torque.
- 20 to 25 second drive timing (load dependant).
- Models available for 24 and 120 Vac.

APPLICATION

The ML4125, ML4135, ML8125 and ML8135 Fast-Acting, Two-Position Actuators are spring return direct coupled actuators (DCA) with an integral junction box for on/off damper control. The actuator accepts an on/off signal from a single-pole, single-throw (spst) controller. Models are available with clockwise (cw) or counterclockwise (ccw) spring return and are designed for heating, ventilation, and air-conditioning (HVAC) applications.

IMPORTANT

This actuator is not to be used in fire/smoke applications requiring UL555/555S approval.

APPLICABLE LITERATURE

— Motor/Actuator Selection Guide for Damper Applications	63-8419
— Engineering Manual of Automatic Control (also called The Gray Manual)	77-1100
— Direct Coupled Actuator Quick Selection Guide	63-8553
— Damper Torque Calculator	63-8437

Contents

Application	1
Features	1
Specifications	2
Ordering Information	2
Installation	4
Operation	6
Checkout	6



SPECIFICATIONS

Models: See Table 1.

Table 1. ML4125/4135, ML8125/8135 DCA Models.

Model	Spring Return Direction	Voltage in Vac	Torque in lb-in. (N•m)
ML4125A	ccw	120	100 (11.3)
ML4125B	cw		
ML4135A	ccw		40 (4.5)
ML4135B	cw		
ML4125C	ccw	230	100 (11.3)
ML4125D	cw		
ML8125A	ccw	24	40 (4.5)
ML8125B	cw		
ML8135A	ccw		
ML8135B	cw		

Dimensions: See Fig. 1.

Electrical Ratings:

Power Input:

ML4125A,B: 120 Vac +10%, -15%, 60 Hz.

ML4125C,D: 230 Vac \pm 10%, 50 Hz.

ML4135: 120 Vac \pm 10%, 60 Hz.

ML8125, ML8135: 24 Vac +20%, -10%, 50/60 Hz.

Power Consumption (at Nominal Voltage):

ML4125A,B: Running: 0.16A, 15W.

Holding: 0.10A, 5W.

ML4125C,D: Running: 0.12A, 18.6W.

Holding: 0.10A, 7W.

ML4135: Running: 0.18A, 18W.

Holding: 0.11A, 9W.

ML8125: Running: 15.6 VA.

Holding: 4 VA.

ML8135: Running: 18 VA.

Holding: 8.5 VA.

Temperature Ratings:

Ambient: -40°F to 130°F (-40°C to 55°C).

Shipping and Storage: -40°F to 140°F (-40°C to 60°C).

Humidity Ratings: 5% to 95% RH noncondensing.

Electrical Connections:

ML4125A,B, ML4135, ML8125, ML8135: Two color coded 16 in. leads; includes ground screw.

ML4125C,D: 1m appliance cable.

Three 7/8 in. holes for conduit connections (fittings not included).

Controller Type:

ML4125A,B, ML4135: Line voltage (120 Vac), two-position, spst (Series 40).

ML4125C,D: Line voltage (230 Vac), two-position, spst (Series 40).

ML8125, ML8135: Low voltage (24 Vac), two-position, spst (Series 80).

Device Weight: 5 lb (2.3 kg).

Stroke: 95° \pm 3°, mechanically limited.

Torque Ratings:

Driving:

Minimum:

ML4125, ML8125: 100 lb-in. (11.3 N•m).

ML4135, ML8135: 40 lb-in. (4.5 N•m).

Typical:

ML4125, ML8125: 170 lb-in. (19.2 N•m).

ML4135, ML8135: 100 lb-in. (11.3 N•m).

Spring Return:

Minimum:

ML4125, ML8125: 80 lb-in. (9 N•m).

ML4135, ML8135: 40 lb-in. (4.5 N•m).

Typical:

ML4125, ML8125: 100 lb-in. (11.3 N•m).

ML4135, ML8135: 50 lb-in. (5.7 N•m).

Derated (from -40°F to 0°F [-40°C to -18°C]):

ML4135, ML8135: 30 lb-in. (3.4 N•m).

Holding (minimum): 100 lb-in. (11.3 N•m).

Stall Maximum:

ML4125, ML8125: 240 lb-in. (27.1 N•m).

ML4135, ML8135: 150 lb-in. (17 N•m).

Noise Rating (Maximum):

Driving/Spring Return: 65 dBA at 1m.

Holding: 20 dBA at 1m (no audible noise).

ORDERING INFORMATION

When purchasing replacement and modernization products from your TRADELINE® wholesaler or distributor, refer to the TRADELINE® Catalog or price sheets for complete ordering number.

If you have additional questions, need further information, or would like to comment on our products or services, please write or phone:

1. Your local Home and Building Control Sales Office (check white pages of your phone directory).
2. Home and Building Control Customer Logistics
Honeywell, 1885 Douglas Drive North
Minneapolis, Minnesota 55422-4386 (612) 951-1000

In Canada—Honeywell Limited/Honeywell Limitée, 155 Gordon Baker Road, North York, Ontario M2H 3N7.

International Sales and Service Offices in all principal cities of the world. Manufacturing in Australia, Canada, Finland, France, Germany, Japan, Mexico, Netherlands, Spain, Taiwan, United Kingdom, U.S.A.

Mounting:

3/8 in. (10 mm) to 1/2 in. (13 mm) square or round damper shafts. Actuator can be mounted with shaft in any position. Secure hub to shaft with:
 ML8125, ML4125A,B: Four 1/4-28 UNF set screws. Use 1/8 in. Allen wrench to tighten set screws.
 ML8135, ML4135: Two 1/4-28 UNF set screws. Use 1/8 in. Allen wrench to tighten set screws.
 ML4125C,D: Four 3 mm set screws. Use 3 mm Allen wrench to tighten set screws.

IMPORTANT

Honeywell does not recommend using linkages with these actuators because side-loading of the output hub reduces actuator life.

Minimum Damper Shaft Length: 1-3/4 in. (45 mm).

Timing:

Drive Open:

ML4125, ML8125: 25 to 40 seconds (load dependant).
 ML4135, ML8135: 20 to 25 seconds (load dependant).

Spring Close:

ML4125, ML8125: 20 to 25 seconds.
 ML4135, ML8135: 15 seconds.

Design Life (at Rated Voltage):

ML4125, ML8125: 80,000 full-stroke cycles.
 ML4135, ML8135: 60,000 full-stroke cycles.

Environmental Protection Ratings: See Table 2.

Table 2. Environmental Ratings.

All Devices	ML4125C,D, ML8125, ML8135
NEMA1	IP54

Approvals: See Table 3.

Accessories:

201391 Shaft Adapter for 3/8 in. (10 mm) shafts.
 205649 Mounting Bracket (included with the actuator).
 32003532-001 Adjustable Switch Package, two 10A externally-mounted fully-adjustable switches.

Table 3. Approvals.

	ML4125		ML4135	ML8125	ML8135
	A,B	C,D			
UL/cUL	X	X	X	X	X
UL873 Plenum Rating, File No. E4436	X	X	X	X	X
CE		X		X	X
C-TICK		X		X	

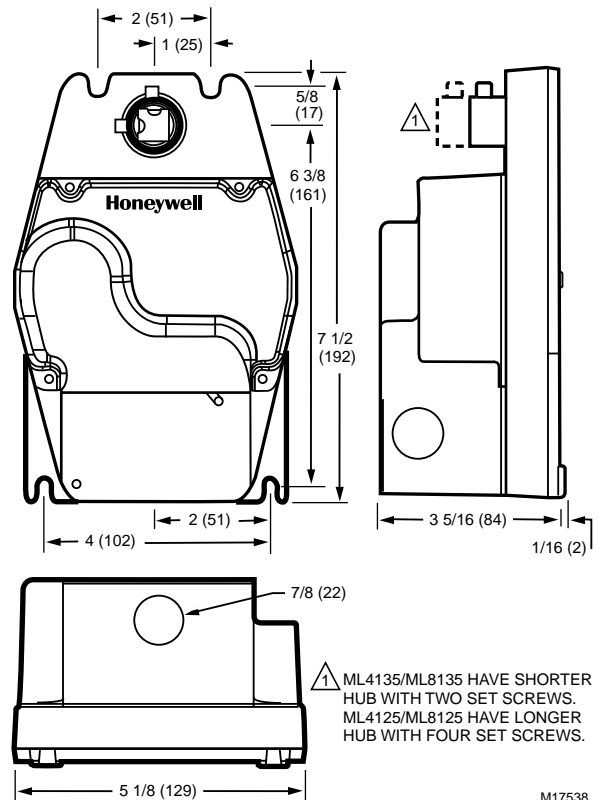

Fig. 1. ML4125/4135, ML8125/8135 dimensiona drawing in in. (mm).

INSTALLATION

When Installing this Product...

1. Read these instructions carefully. Failure to follow them could damage the product or cause a hazardous condition.
2. Check the ratings given in the instructions and on the product to make sure the product is suitable for your application.
3. Installer must be a trained, experienced service technician.
4. After installation is complete, check out product operation as provided in these instructions.

IMPORTANT

All wiring must agree with applicable codes, ordinances and regulations.

WARNING

Electrical Power Hazard.
Line voltage can cause death or serious injury and short equipment circuitry.
Disconnect power supply before installation.



CAUTION

Electrical Shock or Equipment Damage Hazard.
Low voltage can shock individuals or short equipment circuitry.
Disconnect power supply before installation.

Location and Mounting

CAUTION

Equipment Damage Hazard.
Tightly securing actuator to damper housing can damage actuator.
Mount actuator to allow it to float along its vertical axis.

The actuators are designed to open a damper by driving the damper shaft in either clockwise  or counterclockwise  direction. The actuator housing has two slots on the bottom that, with a 205649 Mounting Bracket, secure it flush to a damper box (see Fig. 2). When mounted correctly, these slots allow the actuator to *float* without rotating relative to the damper shaft.

NOTE: ML4125, ML4135, ML8125 and ML8135 Actuators are shipped in the fully closed position.

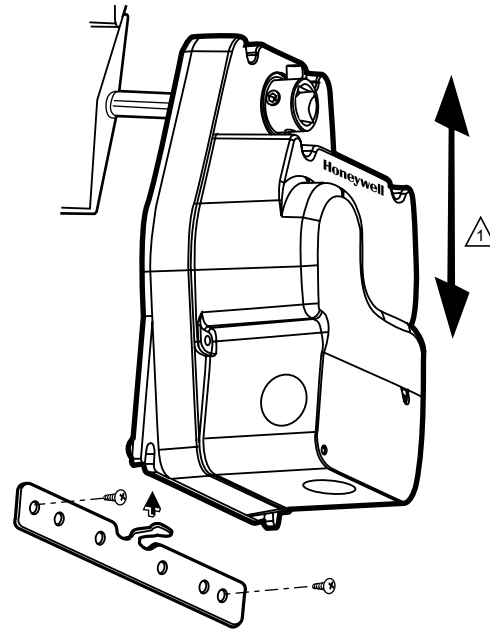

 ENSURE THAT MOUNTING ASSEMBLY PREVENTS ACTUATOR ROTATION AND ALLOWS ACTUATOR TO FLOAT ALONG INDICATED AXIS. WHEN TOO TIGHT, THE RESULTING BINDING CAN DAMAGE THE ACTUATOR OR REDUCE TORQUE OUTPUT. M17519

Fig. 2. Mounting actuator to damper housing.

NOTE: The actuator mounts flush with the damper box.

Preparation

Before mounting the actuator onto the damper shaft, determine the damper shaft size (3/8 in. to 1/2 in. [10 mm to 13 mm]).

If damper shaft is 3/8 in. (10 mm) round or square, use part number 201391 Shaft Adapter. Place adapter opposite set screws (see Fig. 3).

NOTE: The damper shaft adapter centers a 3/8 in. (10 mm) damper shaft in the hub. Failure to use adapter can cause mounting screws to loosen. A 1/2 in. (13 mm) damper shaft does not require an adapter.

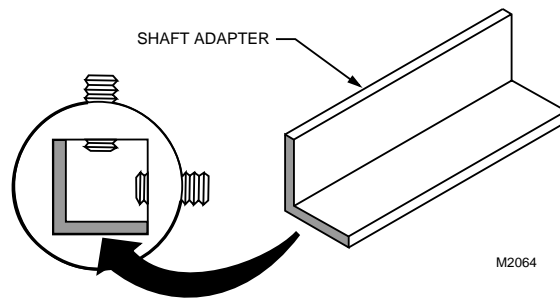

Fig. 3. Using damper shaft adapter for 3/8 in. (10 mm) damper shafts.

Installation

CAUTION

Device Malfunction Hazard.
Improper set screw tightening causes device malfunction.

Tighten set screws with proper torque to prevent damper shaft slippage.

CAUTION

Actuator Damage Hazard.
Using actuator as shaft bearing causes device damage.

Use actuator only to supply rotational torque. Avoid any side loads to actuator output coupling bearings.

To install actuator, proceed as follows:

1. Place actuator over damper shaft; and hold mounting bracket in place. See Fig. 2.
2. Mark screw holes on damper housing.
3. Remove actuator and mounting bracket.
4. Drill or center-punch holes for mounting screws (or use no.10 self-tapping sheet metal screws).
5. Turn damper blades to desired normal (closed) position.
6. Place actuator and mounting bracket back into position and secure bracket to damper box with sheet metal screws.
7. Tighten set screws securely into damper shaft using minimum 30 lb-in., maximum 60 lb-in. torque. Use 1/8 in. or 3 mm Allen wrench (see Specifications for details) to tighten set screws.

Wiring

WARNING

Electrical Power Hazard.
Line voltage can cause death or serious injury and short equipment circuitry.
 Disconnect power supply before installation.

CAUTION

Electrical Shock or Equipment Damage Hazard.
Low voltage can shock individuals or short equipment circuitry.
 Disconnect power supply before installation.

IMPORTANT

1. All wiring must comply with local electrical codes, ordinances and regulations.
2. Voltage and frequency of transformer used with ML8125 or ML8135 must correspond with the characteristics of power supply and actuator.
3. Use wires rated for at least 75°C (167°F).

See Fig. 4 through 6 for typical wiring diagrams.

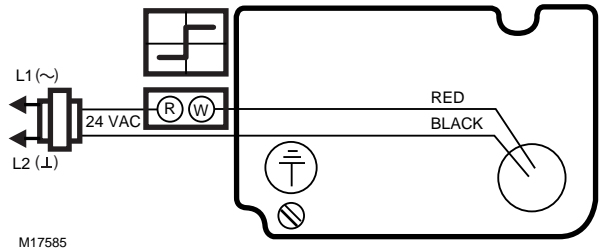

Fig. 4. Typical 24 Vac wiring.

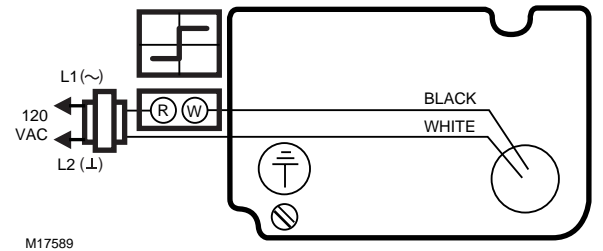

Fig. 5. Typical 120 Vac wiring.

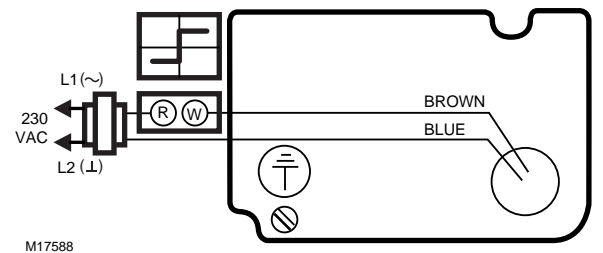

Fig. 6. Typical 230 Vac wiring.

Table 4. Color Translations.

	G	F	I	E
BROWN	BRAUN	BRUN	BRUNO	CAFE
BLUE	BLAU	BLEU	AZZURRO	AZUL
BLACK	SCHWARZ	NOIR	NERO	NEGRO
WHITE	WEISS	BLANC	BIANCO	BLANCO
RED	ROT	ROUGE	ROSSO	ROJO

OPERATION

The actuators are operated by an spst two-position controller. When using an spst two-position controller, the actuator drives to the damper fully open position when controller contact makes and spring returns to the damper fully closed position when controller contact breaks. The actuator drops to holding power level on detection of stall, independent of hub position.

If power fails, the actuator spring returns to the 0° position.

CHECKOUT

ML4125A,B, ML4135 (120 Vac model)

1. Check damper position.
2. Connect 120 Vac to the black and white leadwires to drive the damper to the open position. The actuator should drive the damper.
3. If the actuator does not run, remove power for at least two seconds.
4. If the actuator spring returns, allow it to close entirely, then return to step 2.
5. If the actuator does not spring return, verify that the actuator is properly installed. See Installation section.
6. If the actuator is correctly installed but neither runs nor spring returns, replace the actuator.

ML4125C,D (230 Vac model)

1. Check damper position.
2. Connect 230 Vac to the blue and brown leadwires to drive the damper to the open position. The actuator should drive the damper.
3. If the actuator does not run, remove power for at least two seconds.
4. If the actuator spring returns, allow it to close entirely, then return to step 2.
5. If the actuator does not spring return, verify that the actuator is properly installed. See Installation section.
6. If the actuator is correctly installed but neither runs nor spring returns, replace the actuator.

ML8125, ML8135 (24 Vac model)

1. Check damper position.
2. Connect 24 Vac to the red and black leadwires to drive the damper to the open position. The actuator should drive the damper.
3. If the actuator does not run, remove power for at least two seconds.
4. If the actuator spring returns, allow it to close entirely, then return to step 2.
5. If the actuator does not spring return, verify that the actuator is properly installed. See Installation section.
6. If the actuator is correctly installed but neither runs nor spring returns, replace the actuator.

- D Montageanweisung
- F Instructions d'Installation
- I Istruzioni per l'Installazione
- NL Installatievoorschrift
- DK Installasjonsinstruks
- N Installationsinstruktioner
- SF Asennusohje
- S Installations Instruktioner
- E Instrucciones de montaje

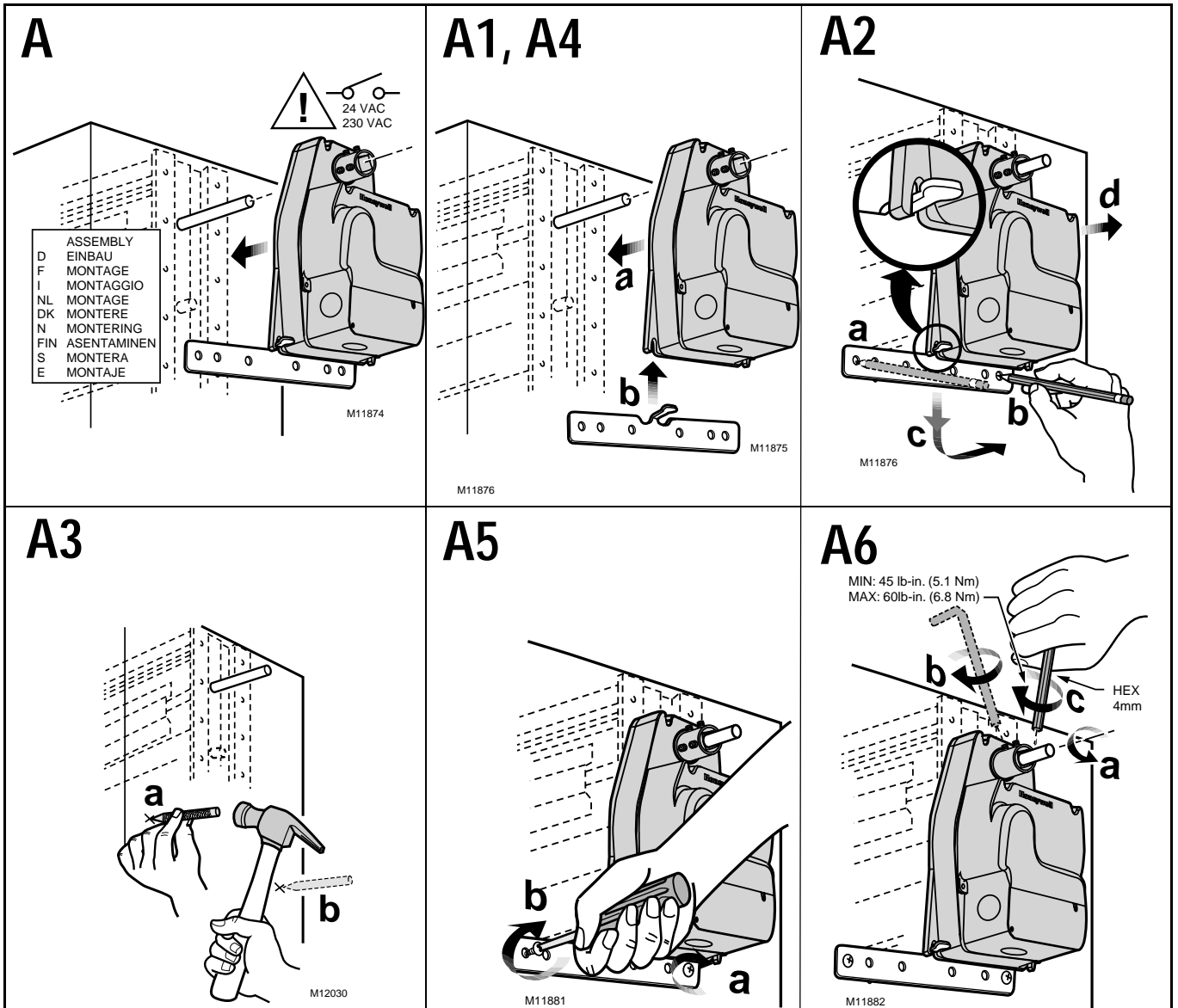

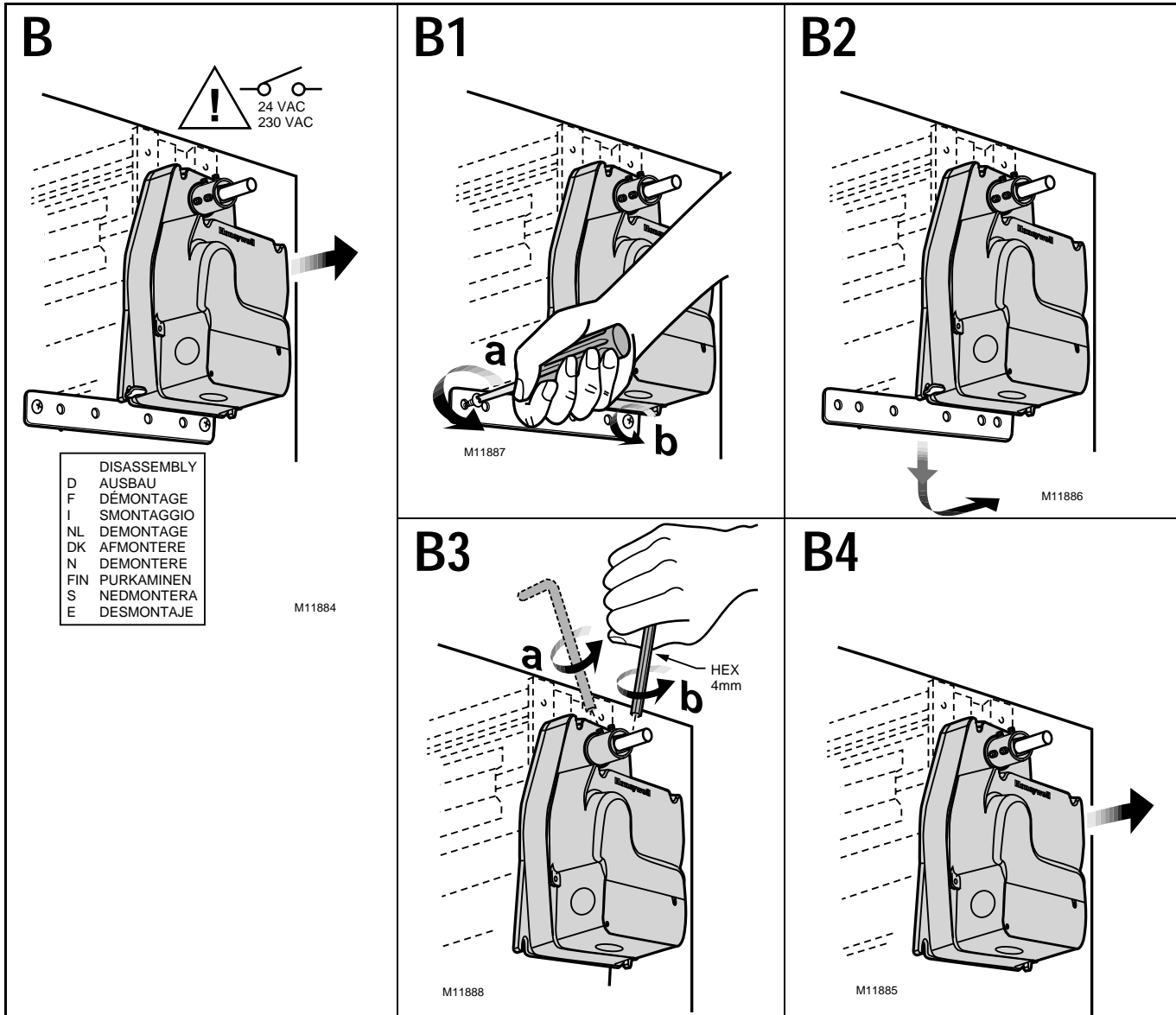

Honeywell

Home and Building Control
Honeywell
1985 Douglas Drive North
Golden Valley, MN 55422

Home and Building Control
Honeywell Limited-Honeywell Limitée
35 Dynamic Drive
Scarborough, Ontario
M1V 4Z9

Honeywell Asia Pacific Inc.
Room 3213-3225
Sun Hung Kai Centre
No. 30 Harbour Road
Wanchai
Hong Kong

Honeywell Europe S.A.
3 Avenue du Bourget
1140 Brussels
Belgium

Honeywell Latin American Region
480 Sawgrass Corporate Parkway
Suite 200
Sunrise FL 33325



Free Manuals Download Website

<http://myh66.com>

<http://usermanuals.us>

<http://www.somanuals.com>

<http://www.4manuals.cc>

<http://www.manual-lib.com>

<http://www.404manual.com>

<http://www.luxmanual.com>

<http://aubethermostatmanual.com>

Golf course search by state

<http://golfingnear.com>

Email search by domain

<http://emailbydomain.com>

Auto manuals search

<http://auto.somanuals.com>

TV manuals search

<http://tv.somanuals.com>