

DPR 1001

Digital Path Receiver
Owner's Manual

harman/kardon®
Power for the Digital Revolution®

DPR 1001 DIGITAL PATH RECEIVER

3	Introduction
4	Safety Information
4	Unpacking
5	Front Panel Controls
7	Front Panel Information Display
8	Rear Panel Connections
10	Main Remote Control Functions
13	Zone II Remote Control Functions
14	Installation and Connections
16	System Configuration
16	Speaker Placement
17	Speaker Optimizer
18	Input Setup
18	Surround Setup
19	Speaker Setup
21	Delay Settings
22	Output Level Adjustment
22	Using EzSet
24	Operation
24	Basic Operation
24	Remote Control Operation
24	Source Selection
25	Volume Control
25	Surround Mode Selection
25	Digital Audio Playback
26	Surround Mode Chart
28	Tuner Operation
28	Recording
29	Front Panel Connections
29	Output Level Trim Adjustment
29	6/8-Channel Direct Input
30	Advanced Features
30	Surround Back Amplifier Assignment
30	Display Brightness
30	Turn-On Volume Level
30	OSD Settings
31	Multiroom Operation
31	Multiroom Setup
32	Multiroom Operation
32	Configuring the Remote
32	Preprogrammed Code Entry
33	Automatic Code Entry
34	Learning Commands
35	Changing Devices
35	Macro Programming
37	Punch-Through Configuration
37	Volume Punch-Through
38	Channel Punch-Through
38	Transport Punch-Through
39	EzSet Configuration
39	Renaming
39	Renaming a Device
40	Renaming Individual Keys
41	Resetting the Remote
42	Troubleshooting Guide
42	Processor Reset
43	Technical Specifications
43	Trademark acknowledgements

Typographical Conventions

In order to help you use this manual with the remote control, front panel controls and rear panel connections, certain conventions have been used.

EXAMPLE – (bold type) indicates a specific remote control or front panel button, or rear panel connection jack

EXAMPLE – (OCR type) indicates a message that is visible on-screen or on the front panel information display

EXAMPLE – (Synchro type) indicates a message that is displayed on the remote's LCD screen

1 – (number in a square) indicates a specific front panel control

① – (number in a circle) indicates a rear panel connection

① – (number in an oval) indicates a button or indicator on the remote

A – (letter in a square) indicates an indicator in the front panel information display

A – (letter in an oval) indicates a button on the Zone II remote

Thank you for choosing Harman Kardon®! With the purchase of a Harman Kardon DPR 1001 you are about to begin many years of listening enjoyment. Designed to provide all the excitement and detail of movie soundtracks and every nuance of musical selections, the DPR 1001 is truly a multichannel receiver for the new millennium.

The DPR 1001 has been engineered so that it is easy to take advantage of all the power of its digital technology. On-screen menus, a fully programmable remote control with an LCD display, fully color-coded connection jacks and terminals, and our exclusive EzSet™ feature make installation fast and simple. However, to obtain the maximum enjoyment from your new receiver, we urge you to read this manual. A few minutes spent learning the functions of the various controls will enable you to take advantage of all the power the DPR 1001 is able to deliver.

If you have any questions about this product, its installation or its operation, please contact your retailer or installer. They are your best local sources of information.

Description and Features

The DPR 1001 is one of the first fully featured A/V receivers to use PWM digital amplifier technology in a high-performance audio/video receiver. A fully digital path from source input to the output stage eliminates the need for digital-to-analog conversion before amplification. This reduces the possibility of signal degradation or the introduction of distortion. Digital technology also enables Harman Kardon to provide seven amplifier channels, while reducing the size and weight of the chassis to a slimmer profile.

The DPR 1001 is among the most versatile and multifeatured A/V receivers available, incorporating a wide range of listening options. In addition to Dolby® Digital, Dolby Digital EX and DTS® decoding for digital sources, a broad choice of surround modes is available for use with PCM digital and analog sources such as CD, VCR, TV broadcasts and the DPR 1001's own FM/AM tuner. Along with Dolby Pro Logic® II, DTS Neo:6®, Dolby 3 Stereo, and Hall and Theater modes, the DPR 1001 offers Harman International's own Logic 7® processing in both 5.1 and 7.1 versions to create a wider, more enveloping field environment and more defined flyovers and pans. Another exclusive is VMAx®, which uses proprietary processing to create an open, spacious sound field when only two front speakers are available. Finally, the DPR 1001 is among the few A/V receivers that offer MP3 decoding, so that you may listen to the latest music selections directly from compatible computers or playback devices with the power and fidelity you expect from Harman Kardon.

In addition to providing a wide range of listening options, the DPR 1001 is easy to configure so that it provides the best results with your speakers and specific listening-room environment. On-screen menus make it simple to enter settings for speaker configurations and bass management, and the EzSet remote measures a system's sound levels and automatically calibrates them for a perfectly balanced sound field presentation.

For the ultimate in flexibility, the DPR 1001 features connections for five video devices, all with both composite and S-Video inputs. Two additional audio inputs are available, and a total of six digital inputs make the DPR 1001 capable of handling all the latest digital audio sources. For compatibility with the latest HDTV video sources and progressive scan DVD players, the DPR 1001 also features high-bandwidth, low-crosstalk component video switching.

Coax and optical digital outputs are available for direct connection to digital recorders, and both the front panel analog audio/video and coaxial digital jacks may be switched to outputs for use with portable recorders – a Harman Kardon exclusive. Two video recording outputs, preamp-out jacks, and a color-coded eight-channel input make the DPR 1001 virtually future-proof.

The DPR 1001's flexibility and power extend beyond your main home theater or listening room. The DPR 1001 includes a sophisticated multizone control system that allows you to select one source for use in the main room and a different one in a second room. You may even assign the surround-back amplifiers to power the second zone for simultaneous 5.1 and remote room operation. Complete control over volume is possible with a separate infrared control link. To make it easy to operate the DPR 1001 from a remote room, a separate "Zone II" remote is included.

Harman Kardon invented the high-fidelity receiver almost fifty years ago. With state-of-the-art circuitry, the DPR 1001 is the perfect combination of the latest in digital audio technology, a quiet and compact yet powerful amplifier in an elegant, easy-to-use package.

For Canadian model

This class B digital apparatus complies with Canadian ICES-003.

For models having a power cord with a polarized plug:
CAUTION: To prevent electric shock, match wide blade of plug to wide slot, fully insert.

- Digital amplifiers provide seven channels of high-performance sound in a compact cabinet without the need for noisy cooling fans
- Dolby® Digital EX 6.1 and Dolby Pro Logic® II decoding, and a wide range of DTS® modes, including DTS-ES® 6.1 Discrete & Matrix and Neo:6®, using a 24-bit Cirrus® DSP engine
- Harman International's proprietary Logic 7® technology, available with both 7.1 and 5.1 processing in a variety of modes and two modes of VMAx®
- MP3 decoding for use with many computers and digital audio players
- LCD remote with EzSet™ automatically sets output levels for optimum performance
- High-bandwidth, HDTV-compatible component video switching
- Front panel digital inputs and coax digital output capability for easy connection to portable digital devices and the latest video game consoles
- Multiple digital inputs and outputs
- Front panel analog A/V and coax digital jacks switchable to outputs for easy connection to portable digital devices or video game consoles
- On-screen menu and display system
- Complete multizone system including capability to configure surround back channels to amplify second zone, with separate "Zone II" remote included

CAUTION

**RISK OF ELECTRIC SHOCK
DO NOT OPEN**

CAUTION: To reduce the risk of electric shock, do not remove the cover. No user serviceable parts inside. Refer servicing to qualified personnel.

 The lightning flash with arrowhead symbol, within an equilateral triangle, is intended to alert the user to the presence of uninsulated "dangerous voltage" within the product's enclosure that may be of sufficient magnitude to constitute a risk of electric shock to persons.

 The exclamation point within an equilateral triangle is intended to alert the user to the presence of important operating and maintenance (servicing) instructions in the literature accompanying the appliance.

Modèle pour les Canadien

Cet appareil numérique de la classe B est conforme à la norme NMB-003 du Canada.

Sur les modèles dont la fiche est polarisée:

ATTENTION: Pour éviter les chocs électriques, introduire la lame la plus large de la fiche dans la borne correspondante de la prise et pousser jusqu'au fond.

SAFETY INFORMATION

Important Safety Information

Verify Line Voltage Before Use

Your DPR 1001 has been designed for use with 120-volt AC current. Connection to a line voltage other than that for which it is intended can create a safety and fire hazard and may damage the unit.

If you have any questions about the voltage requirements for your specific model, or about the line voltage in your area, contact your selling dealer before plugging the unit into a wall outlet.

Do Not Use Extension Cords

To avoid safety hazards, use only the power cord attached to your unit. We do not recommend that extension cords be used with this product. As with all electrical devices, do not run power cords under rugs or carpets or place heavy objects on them. Damaged power cords should be replaced immediately by an authorized service center with a cord meeting factory specifications.

Handle the AC Power Cord Gently

When disconnecting the power cord from an AC outlet, always pull the plug; never pull the cord. If you do not intend to use the unit for any considerable length of time, disconnect the plug from the AC outlet.

Do Not Open the Cabinet

There are no user-serviceable components inside this product. Opening the cabinet may present a shock hazard, and any modification to the product will void your guarantee. If water or any metal object such as a paper clip, wire or a staple accidentally falls inside the unit, disconnect it from the AC power source immediately, and consult an authorized service station.

CATV or Antenna Grounding

If an outside antenna or cable system is connected to this product, be certain that it is grounded so as to provide some protection against voltage surges and static charges. Section 810 of the National Electrical Code, ANSI/NFPA No. 70-1984, provides information with respect to proper grounding of the mast and supporting structure, grounding of the lead-in wire to an antenna discharge unit, size of grounding conductors, location of antenna discharge unit, connection to grounding electrodes and requirements of the grounding electrode.

NOTE TO CATV SYSTEM INSTALLER: This reminder is provided to call the CATV (cable TV) system installer's attention to article 820-40 of the NEC that provides guidelines for proper grounding and, in particular, specifies that the cable ground shall be connected to the grounding system of the building, as close to the point of cable entry as possible.

Installation Location

- To ensure proper operation and to avoid the potential for safety hazards, place the unit on a firm and level surface. When placing the unit on a shelf, be certain that the shelf and any mounting hardware can support the weight of the product.
- Make certain that proper space is provided both above and below the unit for ventilation. If this product will be installed in a cabinet or other enclosed area, make certain that there is sufficient air movement within the cabinet. Under some circumstances a fan may be required.
- Do not place the unit directly on a carpeted surface.
- Avoid installation in extremely hot or cold locations, or in an area that is exposed to direct sunlight or heating equipment.
- Avoid moist or humid locations.
- Do not obstruct the ventilation slots on the top of the unit, or place objects directly over them.
- There is the remote possibility that the rubber padding on the bottom of the unit's feet may leave marks on certain wood or veneer materials. Use caution when placing the unit on soft woods or other materials that may be damaged by heat or heavy objects.

Cleaning

When the unit gets dirty, wipe it with a clean, soft, dry cloth. If necessary, wipe it with a soft cloth dampened with mild soapy water, then a fresh cloth with clean water. Wipe dry immediately with a dry cloth. NEVER use benzene, aerosol cleaners, thinner, alcohol or any other volatile cleaning agent. Do not use abrasive cleaners, as they may damage the finish of metal parts. Avoid spraying insecticide near the unit.

Moving the Unit

Before moving the unit, be certain to disconnect any interconnection cords with other components, and make certain that you disconnect the unit from the AC outlet.

Important Information for the User

This equipment has been tested and found to comply with the limits for a Class-B digital device, pursuant to Part 15 of the FCC Rules. The limits are designed to provide reasonable protection against harmful interference in a residential installation. This equipment generates, uses and can radiate radio-frequency energy and, if not installed and used in accordance with the instructions, may cause harmful interference to radio communication. However, there is no guarantee that harmful interference will not occur in a particular installation. If this equipment does cause harmful interference to radio or television reception, which can be determined by turning the equipment off and on, the

user is encouraged to try to correct the interference by one or more of the following measures:

- Reorient or relocate the receiving antenna.
- Increase the separation between the equipment and receiver.
- Connect the equipment into an outlet on a circuit different from that to which the receiver is connected.
- Consult the dealer or an experienced radio/TV technician for help.

This device complies with Part 15 of the FCC Rules. Operation is subject to the following two conditions: (1) this device may not cause harmful interference, and (2) this device must accept interference received, including interference that may cause undesired operation.

NOTE: Changes or modifications may cause this unit to fail to comply with Part 15 of the FCC Rules and may void the user's authority to operate the equipment.

Unpacking

The carton and shipping materials used to protect your new receiver during shipment were specially designed to cushion it from shock and vibration. We suggest that you save the carton and packing materials for use in shipping if you move, or should the unit ever need repair.

To minimize the size of the carton in storage, you may wish to flatten it. This is done by carefully slitting the tape seams on the bottom and collapsing the carton. Other cardboard inserts may be stored in the same manner. Packing materials that cannot be collapsed should be saved along with the carton in a plastic bag.

If you do not wish to save the packaging materials, please note that the carton and other sections of the shipping protection are recyclable. Please respect the environment and discard those materials at a local recycling center.

At this time you should also remove the protective plastic film from the front panel lens. Leaving the film in place may affect the performance of your remote control.

FRONT PANEL CONTROLS

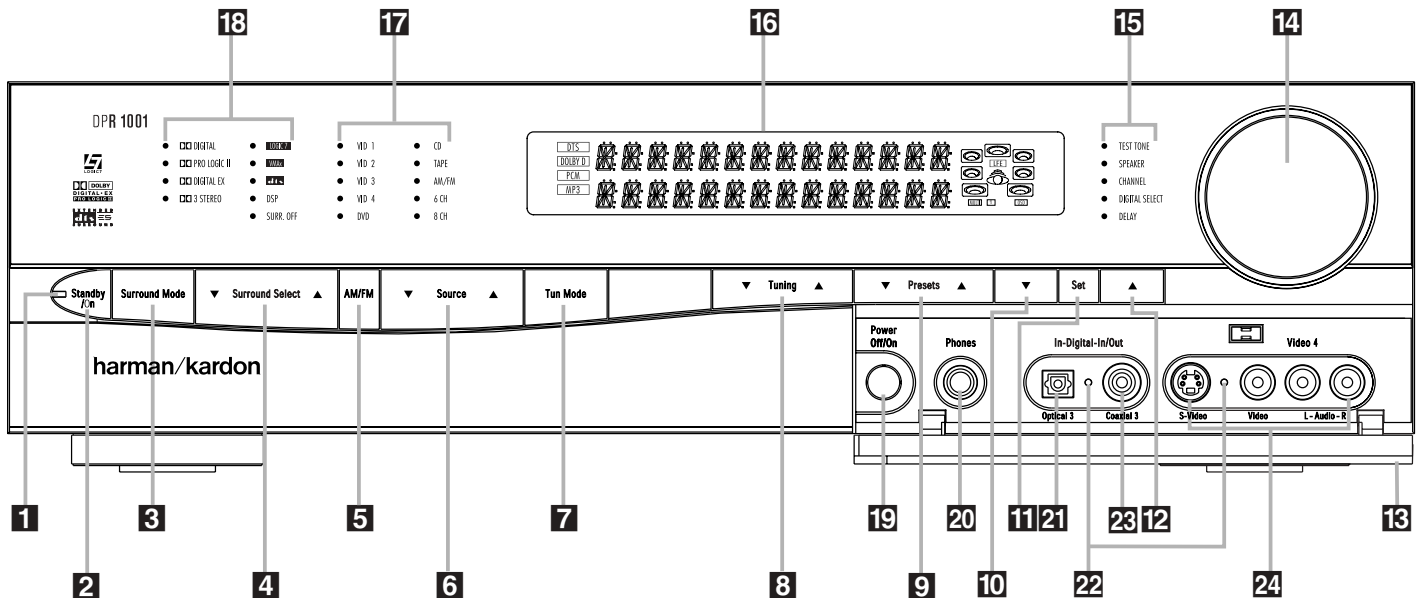

- 1** Power Indicator
- 2** Standby/On Button
- 3** Surround Mode Selector
- 4** Surround Select Button
- 5** AM/FM Selector
- 6** Input Source Selector
- 7** Tuning Mode Selector
- 8** Tuning Selector
- 9** Preset Station Selector

- 10** ▼ Button
- 11** Set Button
- 12** ▲ Button
- 13** Door
- 14** Volume Control
- 15** System Configuration Indicators
- 16** Main Information Display
- 17** Input Indicators
- 18** Surround Mode Indicators

- 19** Main Power Switch
- 20** Headphone Jack
- 21** Digital Optical 3 Input
- 22** Input/Output Status Indicators
- 23** Digital Coax 3 Jack
- 24** Video 4 Input/Output Jacks

NOTE: To make it easier to follow the installation instructions that refer to this illustration, a larger copy may be downloaded from the Product Support section at www.harmankardon.com.

1 Power Indicator: This LED turns red when the unit is in the Standby mode to signal that the unit is ready to be turned on. When the unit is in operation, the indicator will turn green.

2 Standby/On Button: When the Main Power Switch **19** is "ON," press this button to turn on the DPR 1001; press it again to turn the unit off. The Power Indicator **1** will turn green when the unit is on.

NOTE: The Main Power Switch **19** must be turned on before this button will operate.

3 Surround Mode Selector: Press this button to choose a surround processing format category by scrolling through the list of available formats as indicated in the Surround Mode Indicators **18**.

These format categories are: Dolby surround modes, DTS Digital modes, DTS Neo:6 modes, Logic 7 modes, DSP modes and Stereo modes. Once you have selected a format category, use the Surround Select Button **4** to choose a specific mode within the overall category.

4 Surround Select Button: After choosing a surround processing format category by using the Surround Mode Selector **3**, press this button to scroll through the list of available modes for that format category. For example, to select the 7.1 Logic 7 Cinema mode, press the Surround Mode Selector **3** until the indicator next to Logic 7 **18** is lit. Then press the Surround Select Button **4** to scroll through the available choices until the desired mode appears in the Main Information Display **16**. (For more information see page 26.)

5 AM/FM Selector: Pressing this button will automatically switch the DPR 1001 to the Tuner mode. Pressing it again will switch between the AM and FM frequency bands. (See page 28 for more information on the tuner.)

6 Input Source Selector: Press this button to change the input by scrolling up or down through the list of input sources.

7 Tuning Mode Selector: This button is used to switch back and forth between the Auto and Manual tuning modes. In Auto mode, you may use the Tuning Selector **8** to scan through stations with an acceptable signal. In Manual mode, you may use the Tuning Selector **8** to step through one frequency increment at a time.

FRONT PANEL CONTROLS

This button is also used to switch between Stereo and Mono modes for FM radio reception. When weak reception is encountered, press the button to switch to the Mono mode. Press it again to switch back to Stereo mode. (See page 28 for more information on using the tuner.)

8 Tuning Selector: Press the left side of the button to tune lower-frequency stations and the right side of the button to tune higher-frequency stations.

In Manual tuning mode, tap the button lightly and the tuner will step up one frequency increment per button press. When the button is held for a few seconds, the unit will quickly advance through the frequency band. Release it and the tuner will stop. In Auto tuning mode, each press of the button will search for the next station with an acceptable signal. Press and hold the button to skip through the acceptable stations. When the button is released, the tuner will not stop until it reaches a station with an acceptable signal.

To switch back and forth between the Auto and Manual tuning modes, press the **Tuning Mode Selector 7**.

9 Preset Station Selector: Press this button to scroll up or down through the list of stations that have been entered into the preset memory. (See page 28 for more information on tuner programming.)

10 ▼ Button: Use this button to scroll through the System Configuration modes indicated on the front panel: i.e., Test Tone, Speaker, Channel, Digital Select and Delay. Press the **Set Button 11** to select a configuration mode, and use this button or the **▲ Button 12** to scroll through the available adjustments for each System Configuration mode. (See pages 17–23 for more information on configuring the DPR 1001.)

11 Set Button: Press this button to access the configuration menus for Test Tone, Speakers Channel Trim, Digital Input Select or Delay. After pressing the button, use the **▲/▼ Buttons 10/12** to select the desired menu. (See pages 17–23 for more information.)

12 ▲ Button: Use this button to scroll through the System Configuration modes indicated on the front panel: i.e., Test Tone, Speaker, Channel, Digital Select and Delay. Press the **Set Button 11** to select a configuration mode, and use this button or the **▼ Button 10** to scroll through the available adjustments for each System Configuration mode. (See pages 17–23 for more information on configuring the DPR 1001.)

13 Door: Gently pull the upper right corner of this door, indicated by the word "Open", toward you to reveal additional front panel jacks and controls.

14 Volume Control: Turn this knob clockwise to increase the volume, counterclockwise to decrease the volume. If the DPR 1001 is muted, adjusting the volume control will automatically release the unit from the silenced condition.

15 System Configuration Indicators: One of these indicators will light, after the **Set Button 11** has been pressed, to indicate which configuration option is in use. Press the **▲/▼ Buttons 10/12** to change the selection. (See pages 17–23 for more information.)

16 Main Information Display: This display delivers messages and status indications to help you operate the receiver. (See page 7 for a complete explanation of the Main Information Display.)

17 Input Indicators: An LED will light to the left of the input that is currently the input source for the DPR 1001.

18 Surround Mode Indicators: An LED will light in front of the surround mode that is currently in use.

19 Main Power Switch: Press this button in to apply power to the DPR 1001. When the switch is pressed in, the unit is placed in a Standby mode, as indicated by the red **Power Indicator 1**. This button *must* be pressed in to operate the unit. To turn the unit off and prevent the use of the remote control, this switch should be pressed until it pops out from the front panel.

NOTE: This switch is normally left in the "ON" position.

20 Headphone Jack: This jack may be used to listen to the DPR 1001's output through a pair of headphones. Be certain that the headphones have a standard 1/4" stereo phone plug. The main room speakers will automatically be turned off when the headphone jack is in use.

21 Digital Optical 3 Input: Connect the optical digital audio output of an audio or video product to this jack. When the input is not in use, be certain to keep the plastic cap installed to avoid dust contamination that might degrade future performance.

22 Input/Output Status Indicators: These LED indicators will normally light green to show that the front panel **Digital Coax 3 Jack 23** or **Video 4 Input/Output Jacks 24** are operating as inputs. When either of these jacks has been configured for use as an output, the indicator will turn red to show that the jack may be used for recording. (See page 18 or 29 for more information on configuring the front panel jacks as outputs, rather than inputs.)

23 Digital Coax 3 Jack: This jack is normally used for connection to the output of portable audio devices, video game consoles or other products that have a coax digital audio jack. It may also be configured as an output jack, to feed a digital signal to a CD-R, MiniDisc or other digital recording device. (See page 18 or 29 for information on configuring the Digital Coax 3 Jack as an output.)

24 Video 4 Input/Output Jacks: These audio/video jacks may be used for temporary connection to video games or portable audio/video products such as camcorders and portable audio players. These jacks may also be configured as an output to feed an analog audio/video signal to a VCR, camcorder, tape deck or other recording device. (See page 18 or 29 for information on configuring the Video 4 jacks as outputs.)

FRONT PANEL INFORMATION DISPLAY

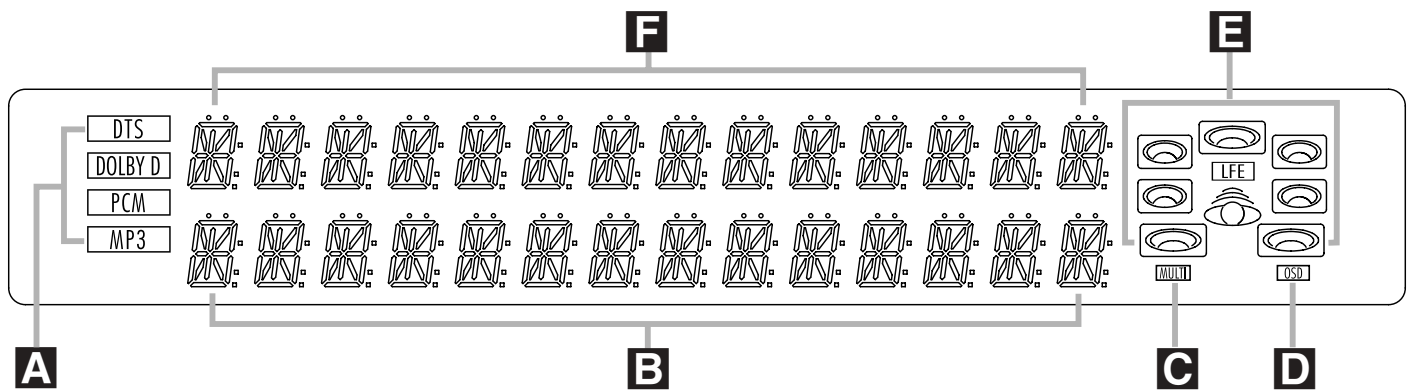

A Bitstream Indicators
B Lower Display Line

C Multiroom Indicator
D OSD Indicator

E Speaker/Channel Input Indicators
F Upper Display Line

NOTE: To make it easier to follow the installation instructions that refer to this illustration, a larger copy may be downloaded from the Product Support section at www.harmanardon.com.

A Bitstream Indicators: When a digital input is playing, one of these indicators will light to display the type of data signal in use.

B Lower Display Line: Depending on the receiver's status, a variety of messages will appear here. In normal operation, the current surround mode name will appear on this line.

C Multiroom Indicator: This indicator lights when the multiroom system is active. Note that it will remain lit when the multiroom system is in use even when the main room system is in the Standby mode and all other indicators are dark. (See page 31 for more information on the Multiroom system.)

D OSD Indicator: When the OSD system is in use, this indicator lights to remind you that the other indicators in this display do not function when the On-Screen Display is being used.

E Speaker/Channel Input Indicators: These indicators are multipurpose, indicating either the speaker type selected for each channel or the number of channels available from the input source. The left, center, right, surround and surround back speaker indicators are composed of overlapping ovals, while the subwoofer is

represented by a single box labeled "LFE". The center oval lights when a "Small" speaker is selected, and the outer oval lights when "Large" speakers are selected. When none of the indicators are lit for a specific channel, no speaker has been selected at that position. (See page 19 for more information on configuring speakers.) The indicators are positioned to correspond to the input channels. For standard analog inputs, only the top left and right indicators will light, indicating a stereo input. When a digital source is playing, the indicators will light to display the channels being received at the digital input. When the indicators flash, the digital input has been interrupted.

F Upper Display Line: Depending on the receiver's status, a variety of messages will appear here. In normal operation, the current input source information will appear on this line, including the input name and an indication as to analog audio or one of the optical or coax digital audio inputs.

REAR PANEL CONNECTIONS

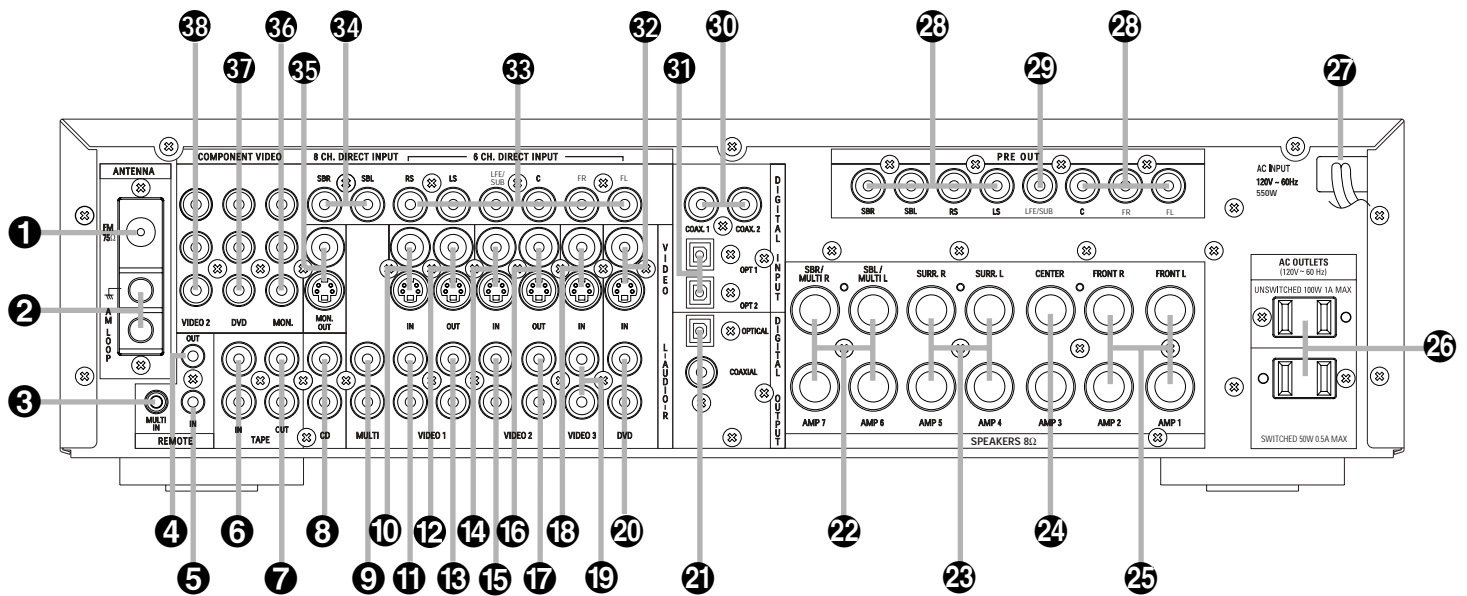

- 1 FM Antenna
- 2 AM Antenna
- 3 Multiroom IR Input
- 4 Remote IR Output
- 5 Remote IR Input
- 6 Tape Inputs
- 7 Tape Outputs
- 8 CD Inputs
- 9 Multiroom Outputs
- 10 Video 1 Video Inputs
- 11 Video 1 Audio Inputs
- 12 Video 1 Video Outputs
- 13 Video 1 Audio Outputs

- 14 Video 2 Video Inputs
- 15 Video 2 Audio Inputs
- 16 Video 2 Video Outputs
- 17 Video 2 Audio Outputs
- 18 Video 3 Video Inputs
- 19 Video 3 Audio Inputs
- 20 DVD Audio Inputs
- 21 Digital Audio Outputs
- 22 Surround Back/Multiroom Speaker Outputs
- 23 Surround Speaker Outputs
- 24 Center Speaker Outputs
- 25 Front Speaker Outputs
- 26 AC Accessory Outlets

- 27 AC Power Cord
- 28 Preamp Outputs
- 29 LFE/Subwoofer Output
- 30 Coaxial Digital Audio Inputs
- 31 Optical Digital Audio Inputs
- 32 DVD Video Inputs
- 33 6-Channel Direct Inputs
- 34 8-Channel Direct Inputs
- 35 Video Monitor Outputs
- 36 Video Monitor Component Video Outputs
- 37 DVD Component Video Inputs
- 38 Video 2 Component Video Inputs

To assist you in making the correct connections for multichannel input, output and speaker connections, all connection jacks and terminals have been color-coded in conformance with the CEA standards as follows:

Front Left: White
 Front Right: Red
 Center: Green
 Surround Left: Blue
 Surround Right: Gray
 Surround Back Left: Brown
 Surround Back Right: Tan

Subwoofer: Purple
 Digital Audio: Orange
 Composite Video: Yellow
 Component Video "Y": Green
 Component Video "Pr": Red
 Component Video "Pb": Blue

NOTE: To make it easier to follow the installation instructions that refer to this illustration, a larger copy may be downloaded from the Product Support section at www.harmanardon.com.

- 1 FM Antenna:** Connect the supplied indoor (or an optional external) FM antenna to this terminal.
- 2 AM Antenna:** Connect the AM loop antenna supplied with the receiver to these terminals. Connect the black antenna wire marked GND to the top terminal screw on the DPR with the grounding symbol.
- 3 Multiroom IR Input:** Connect the output of an IR sensor in a remote room to this jack to operate the DPR 1001's multiroom control system. (See pages 31 for more information on multiroom systems.)
- 4 Remote IR Output:** This connection permits the

IR sensor in the receiver to serve other remote controlled devices. Connect this jack to the "IR IN" jack on Harman Kardon (or other compatible) equipment.

5 Remote IR Input: If the DPR 1001's front panel IR sensor is blocked due to cabinet doors or other obstructions, an external IR sensor may be used. Connect the output of the sensor to this jack.

6 Tape Inputs: Connect these jacks to the PLAY/OUT jacks of an audio recorder.

7 Tape Outputs: Connect these jacks to the RECORD/INPUT jacks of an audio recorder.

8 CD Inputs: Connect these jacks to the output of a compact disc player or changer.

9 Multiroom Outputs: Connect these jacks to an optional audio power amplifier to listen to the source selected by the multiroom system. (See page 31 for more information on the multiroom system.)

10 Video 1 Video Inputs: Connect these jacks to the PLAY/OUT composite or S-Video jacks on a VCR or other video source.

11 Video 1 Audio Inputs: Connect these jacks to the PLAY/OUT audio jacks on a VCR or other video source.

12 Video 1 Video Outputs: Connect these jacks to the RECORD/INPUT composite or S-Video jack on a VCR.

13 Video 1 Audio Outputs: Connect these jacks to the RECORD/INPUT audio jacks on a VCR.

14 Video 2 Video Inputs: Connect these jacks to the PLAY/OUT composite or S-Video jacks on a TV or other video source.

15 Video 2 Audio Inputs: Connect these jacks to the PLAY/OUT audio jacks on a TV or other video source.

16 Video 2 Video Outputs: Connect these jacks to the RECORD/INPUT composite or S-Video jacks on a TV or other video source.

17 Video 2 Audio Outputs: Connect these jacks to the RECORD/INPUT audio jacks on a TV or other video source.

18 Video 3 Video Inputs: Connect these jacks to the PLAY/OUT composite or S-Video jacks on a cable box or other video source.

19 Video 3 Audio Inputs: Connect these jacks to the PLAY/OUT audio jacks on a cable box or other video source.

20 DVD Audio Inputs: Connect these jacks to the analog audio jacks on a DVD or other video source.

21 Digital Audio Outputs: Connect these jacks to the matching digital input connector on a digital recorder such as a CD-R or MiniDisc recorder.

22 Surround Back/Multiroom Speaker Outputs: These speaker terminals may be used with 7.1-channel systems or to power the output of the multiroom system when the multiroom system and the main room are using the same input. Connect these outputs to the matching + and – terminals on your surround back channel speakers. In conformance with the CEA color-code specification, the brown terminal is the positive (+) terminal that should be connected to the red (+) terminal on the Surround Back Left speaker with older color-coding, while the tan terminal should be connected to the red (+) terminal on the Surround Back Right speaker with older color-coding. Connect the black (–) terminal on the receiver to the matching black negative (–) terminals for each surround back speaker. (See page 14 for more information on speaker polarity and pages 19–20 for information on configuring the DPR 1001 for 7.1 speaker channels. See page 31 for information on powering the multiroom system with the DPR 1001's internal amplifier.)

23 Surround Speaker Outputs: Connect these outputs to the matching + and – terminals on your surround channel speakers. In conformance with the

new CEA color-code specification, the blue terminal is the positive (+) terminal that should be connected to the red (+) terminal on the Surround Left speaker with older color-coding, while the gray terminal should be connected to the red (+) terminal on the Surround Right speaker with the older color-coding. Connect the black (–) terminal on the receiver to the matching black negative (–) terminals for each surround speaker. (See page 14 for more information on speaker polarity.)

24 Center Speaker Outputs: Connect these terminals to the matching + and – terminals on your center channel speaker. In conformance with the new CEA color-code specification, the green terminal is the positive (+) terminal that should be connected to the red (+) terminal on speakers with the older color-coding. Connect the black (–) terminal on the receiver to the black negative (–) terminal on your speaker. (See page 14 for more information on speaker polarity.)

25 Front Speaker Outputs: Connect these outputs to the matching + or – terminals on your left and right speakers. The white terminal is the positive (+) terminal that should be connected to the red (+) terminal on the Front Left speaker with older color-coding, while the red terminal should be connected to the red (+) terminal on the Front Right speaker with the older color-coding. Connect the black (–) terminal on the receiver to the matching black negative (–) terminals for each front speaker. (See page 14 for more information on speaker polarity.)

26 AC Accessory Outlets: These outlets provide power for low-current devices such as a VCR, cable box, CD or DVD player. However, they should *not* be used with high-current devices such as amplifiers. The total power consumption of all devices connected to the accessory outlets should not exceed 100 watts.

The bottom outlet is switched, which means that power is supplied only when the DPR is turned on. Since the power is removed when the DPR is turned off, this outlet should not be used for devices such as VCRs where a constant power source is required for a clock or timer.

The top outlet is unswitched, which means that power is available only when the DPR is plugged in.

27 AC Power Cord: Connect the AC plug to an unswitched AC wall output.

28 Preamp Outputs: These jacks may be connected to an external power amplifier.

29 LFE/Subwoofer Output: Connect this jack to the line-level input of a powered subwoofer. This output is filtered, and should be connected to your subwoofer's LFE or other input that bypasses the subwoofer's internal crossover. Consult the owner's manual for

your subwoofer for further information. If an external subwoofer amplifier is used, connect this jack to the subwoofer amplifier input.

30 Coaxial Digital Audio Inputs: Connect the coax digital audio output from a DVD player, HDTV receiver, cable box or satellite receiver, the S/P-DIF output of a compatible computer sound card playing MP3 files or streams, an LD player or a CD player to these jacks. The signal may be a Dolby Digital, DTS or compatible MP3 signal, or standard PCM digital source. Do not connect the RF digital output of an LD player directly to these jacks.

31 Optical Digital Audio Inputs: Connect the optical digital audio output from a DVD player, HDTV receiver, cable box or satellite receiver, the S/P-DIF output of a compatible computer sound card playing MP3 files or streams, an LD player or a CD player to these jacks. The signal may be a Dolby Digital signal, DTS signal, compatible MP3 signal or standard PCM digital source.

32 DVD Video Inputs: Connect these jacks to the composite or S-Video output jacks on a DVD or other video source.

33 6-Channel Direct Inputs: When an optional playback device such as a DVD-Audio or SACD player with 5.1 audio capability is in use, connect the player's output jacks here.

34 8-Channel Direct Inputs: When an optional playback device such as a DVD-Audio or SACD player with 6.1 or 7.1 audio capability is in use, first connect the Front, Center and Surround Channel outputs to the 6-Channel Direct Input Jacks **33**, then connect the Surround Back channel outputs of the player to these input jacks.

35 Video Monitor Outputs: Connect this jack to the composite or S-Video input of a TV monitor or video projector to view the on-screen menus and the output of a composite or S-Video source selected by the DPR 1001.

36 Video Monitor Component Video Outputs: Connect these outputs to the component video inputs of a video projector or monitor. When a source connected to one of the two Component Video Inputs **37** **38** is selected the signal will be sent to these jacks.

37 DVD Component Video Inputs: Connect the Y/Pr/Pb component video outputs of a DVD player to these jacks.

38 Video 2 Component Video Inputs: Connect the Y/Pr/Pb component video outputs of an HDTV set-top converter, satellite receiver or other video source device with component video outputs to these jacks.

MAIN REMOTE CONTROL FUNCTIONS

- 1 Power Off Button
- 2 Power On Button
- 3 LCD Information Display
- 4 Input Selectors
- 5 AVR Selector
- 6 Test Button
- 7 DSP Surround Mode Selector
- 8 Logic 7 Mode Select Button
- 9 Direct Button
- 10 Clear Button
- 11 Numeric Keys
- 12 Tuning Mode Button
- 13 Channel Select Button
- 14 Navigation Button
- 15 Digital Select Button
- 16 Set Button
- 17 Transport Play Buttons
- 18 Volume Up/Down Buttons
- 19 Transport Fast-Play/Scan Buttons
- 20 Main Transport Controls
- 21 Track Skip Up/Down Buttons
- 22 Preset Up/Down Button
- 23 Tuning Up/Down Button
- 24 Disc Skip Button
- 25 Program Button
- 26 Light Button
- 27 Multiroom Button
- 28 Macro Buttons
- 29 Sleep Button
- 30 Night Mode Button
- 31 OSD Button
- 32 Tone Control Button
- 33 Mute Button
- 34 AM/FM Button
- 35 Channel Up/Down Selector
- 36 Delay Select Button
- 37 Speaker Select Button
- 38 Memory Button
- 39 Stereo Mode Select Button
- 40 DTS Neo:6 Mode Select Button
- 41 DTS Digital Mode Select Button
- 42 Dolby Surround Mode Select Button
- 43 6/8-Channel Input Select
- 44 SPL Select Button
- 45 EzSet Microphone Sensor
- 46 Lens

NOTES:

- The function names shown here are each button's feature when used with the DPR 1001. Most buttons have additional functions when used with other devices. When a button is pressed, the function name will appear in the bottom line of the LCD Information Display **3**.
- The jack on the upper right side of the remote is reserved for future use. Do not remove the plug provided or connect any device to the jack.
- To make it easier to follow the installation instructions that refer to this illustration, a larger copy may be downloaded from the Product Support section at www.harman-kardon.com.

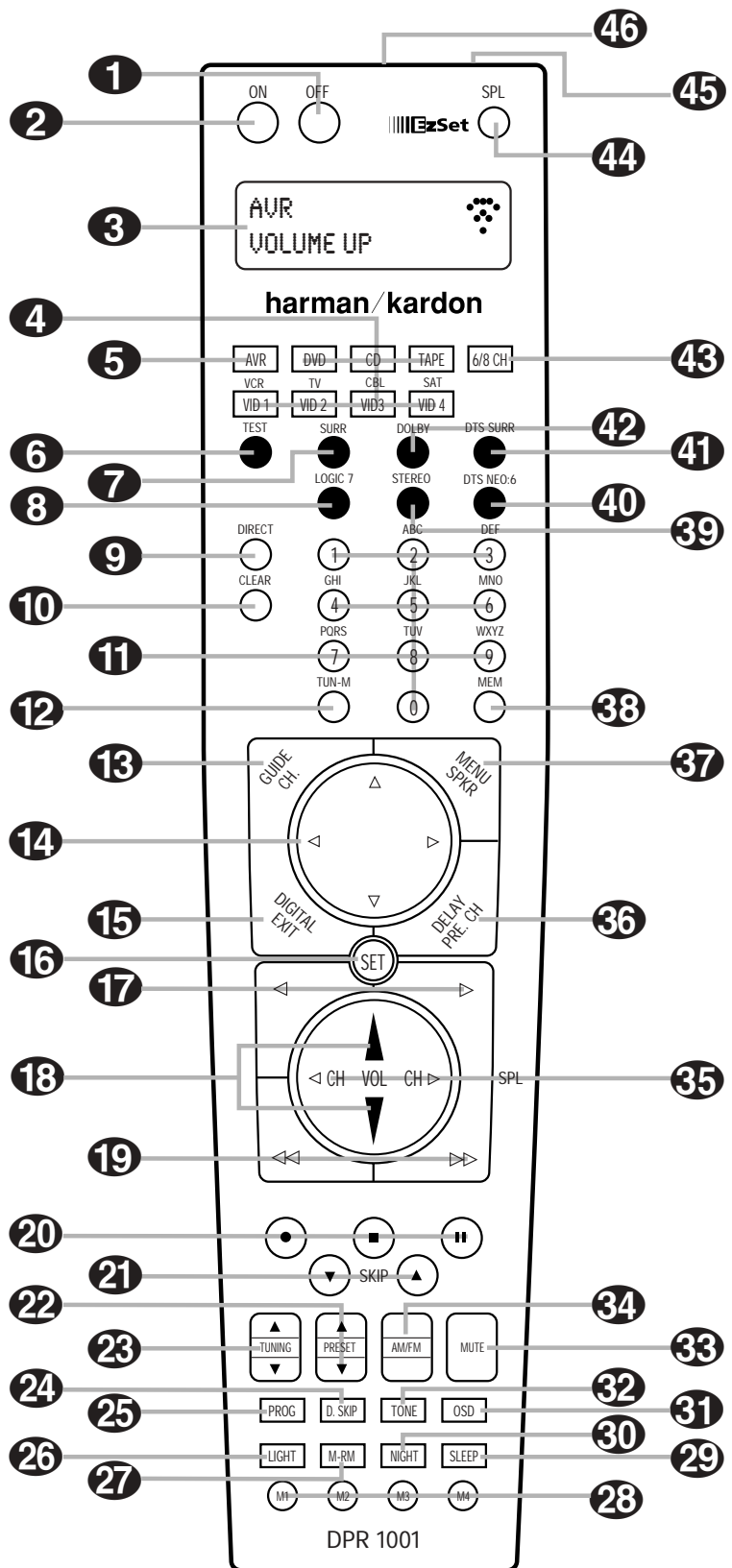

MAIN REMOTE CONTROL FUNCTIONS

IMPORTANT NOTE: The DPR 1001's remote may be programmed to control up to eight devices, including the DPR 1001. Before using the remote, it is important to remember to press the **Input Selector Button 4** that corresponds to the unit you wish to operate. In addition, the DPR 1001's remote is shipped from the factory to operate the DPR 1001 and most Harman Kardon CD or DVD players and cassette decks. The remote is also capable of operating a wide variety of other products using the control codes that are part of the remote. Before using the remote with other products, follow the instructions on pages 32–34 to program the proper codes for the products in your system.

It is also important to remember that many of the buttons on the remote take on different functions, depending on the product selected using the Device Control Selectors. The descriptions shown here primarily detail the functions of the remote when it is used to operate the DPR 1001.

1 Power Off Button: Press this button to place the DPR 1001 or a selected device in the Standby mode. Note that this will turn off the main room functions, but if the Multiroom system is activated, it will continue to function.

2 Power On Button: Press this button to turn on the power to a device selected by first pressing one of the **Input Selectors 4**.

3 LCD Information Display: This two-line screen displays various information depending on the commands that have been entered into the remote.

4 Input Selectors: Pressing one of these buttons will perform three actions at the same time. First, if the DPR 1001 is not turned on, this will power up the unit. Next, it will select the source shown on the button as the input to the DPR 1001. Finally, it will change the remote control so that it controls the device selected. After pressing one of these buttons you must press the **AVR Selector Button 5** again to operate the DPR 1001's functions with the remote.

5 AVR Selector: Pressing this button will switch the remote so that it will operate the DPR 1001's functions. If the DPR 1001 is in the Standby mode, it will also turn the DPR 1001 on.

6 Test Button: Press this button to begin the sequence used to calibrate the DPR 1001's output levels. (See page 23 for more information on calibrating the DPR 1001.)

7 DSP Surround Mode Selector: Press this button to select from among the available DSP surround modes. (See page 26 for more information on the Theater, Hall and VMaX modes.)

8 Logic 7 Selector: Press this button to select from among the available Logic 7 surround modes. (See page 26 for the available Logic 7 options.)

9 Direct Button: Press this button when the tuner is in use to start the sequence for direct entry of a station's frequency. After pressing the button, simply press the proper **Numeric Keys 11** to select a station. (See page 28 for more information on the tuner.)

10 Clear Button: When programming the remote or using the EzSet feature, press this button to cancel the current function. When using the remote to enter frequencies for direct tuner access, press this button to clear previous entries.

11 Numeric Keys: These buttons serve as a ten-button numeric keypad to enter tuner preset positions. They are also used to select channel numbers when TV, Cable or SAT has been selected on the remote, or to select track numbers on a CD, DVD or LD player, depending on how the remote has been programmed.

12 Tuning Mode: Press this button when the tuner is in use to select between automatic tuning and manual tuning. When the button is pressed so that **MANUAL TUNING** appears in the **Lower Display Line 3**, pressing the **Tuning Selector 8** will move the frequency up or down in single-step increments. When the FM band is in use, pressing this button for manual tuning when a station's signal is weak will change to monaural reception. (See page 28 for more information.)

13 Channel Select Button: This button is used to start the process of setting the DPR 1001's output levels to an external source. Once this button is pressed, press the **▲/▼** on the **Navigation Button 14** to select the channel being adjusted, then press the **Set Button 16**, followed by the **▲/▼** on the **Navigation Button 14** again, to change the level setting. (See page 29 for more information.)

14 Navigation Button: This single disc-like button is used to navigate through the on-screen configuration menus, to scroll through the options list and to select choices for the various settings such as delay, speakers, surround modes, digital inputs, etc. To use the button, simply press it left, right, up or down in the direction indicated by the **▲▼◀▶** icons printed on the button disc. Depending on the menu being used, pressing the button will either change the video highlight that indicates a specific choice or it will change the option shown in the on-screen or front panel display. The sections in this manual describing the unit's individual features and configuration options contain specific information on how the navigation controls are used.

15 Digital Select Button: Press this button to assign one of the digital inputs **30 31 21 23** to a source. (See page 27 for more information on using digital inputs.)

16 Set Button: This button is used to enter settings into the DPR 1001's memory. It is also used in the setup procedures for delay time, speaker configuration and channel output level adjustment.

17 Transport Play Buttons: These buttons have no direct function on the DPR 1001, but they are used when the remote is programmed for a compatible DVD, CD or tape player. Pressing these buttons will transmit a forward- or reverse-play command, according to the capabilities of the player being controlled. In the factory default setting, these buttons are programmed for Harman Kardon DVD players so that you may control a compatible player without having to switch devices.

18 Volume Up/Down Buttons: These controls share the common disc in the lower third of the remote. To raise the volume, press the button marked **▲** by pressing towards the top of the remote. To lower the volume, press the button marked **▼** by pressing towards the bottom of the remote. The **◀▶** buttons on the left and right sides of this disc change channels up or down when the TV, cable box or satellite **Input Selectors 4** have been pressed.

19 Transport Fast-Play/Scan Buttons: These buttons have no direct function on the DPR 1001, but they are used when the remote is programmed for a compatible DVD, CD or tape player. Pressing these buttons will transmit a fast-play forward, fast-play reverse, or fast-forward or -reverse scan command, according to the capabilities of the player being controlled. In the factory default setting, these buttons are preprogrammed with the remote codes for Harman Kardon DVD players so that you may control a compatible player without having to switch devices.

20 Main Transport Controls: These buttons have no direct function on the DPR 1001, but they are used when the remote is programmed for a compatible DVD, CD or tape player. Pressing these buttons will transmit a stop (■) record (●) or pause (⏸) command, according to the capabilities of the player being controlled. In the factory default setting, these buttons are programmed with the remote codes for Harman Kardon DVD players so that you may control a compatible player without having to switch devices.

21 Track Skip Up/Down Button: This button does not have a direct function with the DPR 1001, but when used with a compatibly programmed CD or DVD changer it will change the track or chapter currently being played. In the factory default setting, this button is programmed with the remote codes for Harman Kardon DVD players so that you may control a compatible player without having to switch devices.

22 Preset Up/Down Button: When the tuner is in use, press this button to scroll through the stations programmed into the DPR 1001's memory.

MAIN REMOTE CONTROL FUNCTIONS

23 Tuning Up/Down: When the tuner is in use, this button will tune up or down through the selected frequency band. If the **Tuning Mode Button 12 7** has been pressed so that **AUTO** appears in the **Lower Display Line B**, pressing either button will cause the tuner to seek the next station with acceptable signal strength for quality reception. When **MANUAL** appears in the **Lower Display Line B**, pressing this button will tune stations in single-step increments. (See page 28 for more information.)

24 Disc Skip Button: This button has no direct function for the DPR 1001 but may be used to change the disc in a CD or DVD changer when the remote is programmed for that type of device. (See page 35 for more information.)

25 Program Button: This button is used to begin the process of programming the remote. Press and hold this button for three seconds to place the remote in the programming mode. Once the red LED under the **Set Button 16** lights, release the button. You may then select from the desired option. (See pages 32–41 for more information on configuring the remote.)

26 Light Button: Press this button to activate the remote's backlight for ease of use in darkened rooms.

27 Multiroom: Press this button to activate the multiroom system or to begin the process of changing the input or volume level for the second zone. (See page 31 for more information on the multiroom system.)

28 Macro Buttons: Press these buttons to store or recall a "Macro", which is a preprogrammed sequence of commands stored in the remote. (See page 35 for more information on macros.)

29 Sleep Button: Press this button to place the unit in the Sleep mode. After the time shown in the display, the DPR 1001 will automatically go into the Standby mode. Each press of the button changes the time until turn-off in the following order:

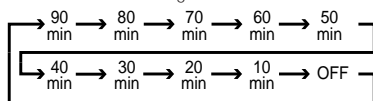

30 Night Mode: Press this button to activate the Night mode. This mode is available in specially encoded Dolby Digital sources, and it preserves dialogue (center channel) intelligibility at low volume levels.

31 OSD Button: Press this button to activate the On-Screen Display (OSD) system used to set up or adjust the DPR 1001's parameters.

32 Tone Control Button: This button controls whether or not the Bass and Treble controls are active, and, if so, the degree to which they are used. The first press of this button tells the current status of the tone controls: If **TONE OUT** is displayed in the Lower

Display Line **B**, the tone controls are not in the signal path, and the DPR's output is "flat." If **TONE IN** is displayed, the controls are active. To switch the tone controls in or out, press the **▲/▼ Navigation Button 14** so that the desired setting appears. To change the actual bass or treble settings, first make certain that **TONE IN** has been activated, and then press the button again so that either **BASS MODE** or **TREBLE MODE** appears. Within five seconds, press the **▲/▼ Navigation Button 14** to enter the desired setting.

33 Mute: Press this button to momentarily silence the DPR 1001 or TV set being controlled, depending on which device has been selected.

34 AM/FM Tuner Select: Press this button to select the DPR 1001's tuner as the listening choice. Pressing this button when the tuner is already in use will select between the AM and FM bands.

35 Channel Up/Down Selector: These buttons have no function when the DPR is being controlled, but when programmed for use with a VCR, TV, cable box, satellite receiver or other similar product they will change the channel up or down. See pages 32–34 for more information on programming the remote.

36 Delay/Select: Press this button to begin the process for setting the delay times used by the DPR 1001 when processing surround sound. After pressing this button, the delay times are entered by pressing the **Set Button 16** and then the **▲/▼ Navigation Button 14** to change the setting. Press the **Set Button 16** again to complete the process. (See page 21 for more information on setting delay times.)

37 Speaker Select: Press this button to begin the process of configuring the DPR 1001's bass management system. Then press the **▲/▼ Navigation Button 14** to select the channel you wish to set up. Press the **Set Button 16** and then select the speaker type. When all adjustments have been completed, press the **Set Button 16** twice to exit the settings and return to normal operation. (See page 19 for more information on speaker setup.)

38 Memory Button: Press this button to enter a radio station into the DPR 1001's preset memory. Once **PRESET MEMORY** flashes in the **Lower Display Line B**, you have five seconds to enter a preset memory location using the **Numeric Keys 11**. (See page 28 for more information.)

39 Stereo Mode Selector: Press this button to select a stereo listening mode. The first press of the button places the DPR 1001 in a true, two-channel, left/right Stereo mode with no surround processing. The next press selects either five-channel Stereo or

seven-channel Stereo, depending on the speaker configuration.

40 DTS Neo:6 Mode Selector: Press this button to select a DTS Neo:6 mode. (See page 26 for the available DTS Neo: 6 options.)

41 DTS Digital Mode Selector: When a DTS-encoded digital source is playing, each press of this button will scroll through the available DTS modes. The specific choice of modes will vary according to the type of encoding on the disc and your system's speaker configuration. When a DTS source is not in use, this button has no function. (See page 26 for the available DTS digital options.)

42 Dolby Surround Mode Selector: This button is used to select from the available Dolby Surround modes. Each press of this button will select one of the Dolby Pro Logic II modes or Dolby 3 Stereo. When a Dolby Digital-encoded source is in use, the Dolby Digital mode may also be selected. (See page 26 for the available Dolby surround mode options.)

43 6-Channel/8-Channel Input Select: Press this button to select the device connected to the **6-Channel Direct Inputs 33** or the **8-Channel Direct Inputs 34**. (See page 29 for more information.)

44 SPL Select: This button activates the DPR 1001's EzSet function to quickly and accurately calibrate the DPR 1001's output levels. When the button is pressed you will then need to select between automatic EzSet operation or using the remote as a manual SPL meter by pressing the **▲/▼ Navigation Button 14** until your choice appears in the remote's LCD display. Press the **Set Button 16** to enter the setting, and then follow the instructions as displayed in the LCD display. For complete information, see page 22.

45 EzSet Microphone Sensor: The microphone sensor that is used by the EzSet system is behind the three slots at the top of the remote control. When using EzSet to calibrate the DPR 1001 be certain that the slots are not covered. (See page 22 for more information on using EzSet.)

46 Lens: The infrared emitters behind the plastic lens at the top of the remote communicate the remote codes to the DPR 1001. Be certain that the lens is not covered when using the remote, and point the lens toward the DPR for best results. In learning mode, the remote receives IR codes to be learned through a sensor behind the lens.

NOTE: DO NOT remove the rubber plug that is supplied to cover the jack on the upper right side of the remote. The jack is not active and is reserved for future use.

ZONE II REMOTE CONTROL FUNCTIONS

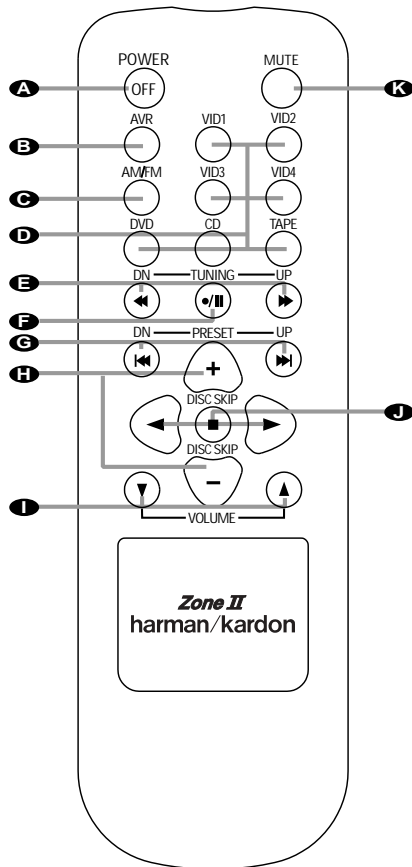

- A** Power Off
- B** AVR Selector
- C** AM/FM Tuner Select
- D** Input Selectors
- E** Tuning Up/Down – Fast-Play
- F** Record/Pause
- G** Preset/Up/Down – Track Skip
- H** Disc Skip
- I** Volume Up/Down
- J** Play Forward/Reverse/Stop
- K** Mute

A Power Off: When used in the room where the DPR 1001 is located, press this button to place the unit in Standby. When it is used in a remote room with a sensor that is connected to the **Multiroom IR Jack 3**, this button turns the Multiroom system off.

B AVR Selector: Press this button to turn on the DPR 1001. The input in use when the unit was last on will be selected.

C AM/FM Tuner Select: Press this button to select the Tuner as the input to the Multiroom system. Press it again to change between the AM and FM bands.

D Input Selectors: When the DPR 1001 is off, press one of these buttons to select a specific input and turn the unit on. When the unit is already in use, pressing one of these buttons will change the input.

E Tuning Up/Down – Fast-Play: These buttons may be used to change the frequency of the tuner. These buttons may also control the Fast-Play or Fast-Reverse functions of compatible Harman Kardon CD, DVD or cassette decks in the same room, or from a remote room when an IR link is connected to the DPR 1001.

F Record/Pause: Press this button to activate either the Record or Pause function on compatible Harman Kardon CD, DVD or Cassette Deck products.

G Preset Up/Down – Track Skip: When the DPR 1001's tuner is selected as the input source, these buttons will move up or down through the list of stations that have been stored in the preset memory. When a CD or DVD changer or player is selected, these buttons activate the Forward or Reverse Track or Chapter Skip functions.

NOTES:

- The Zone II remote may be used in either the same room where the DPR 1001 is located, or it may be used in a separate room with an optional infrared sensor that is connected to the DPR 1001's **Multiroom IR Input Jack 3**. When it is used in the same room as the DPR 1001, it will control the functions of the DPR 1001 or any compatible Harman Kardon products in that room. When it is used in a separate room via a sensor connected to the **Multiroom IR Jack 3**, the buttons for power, input source, volume and mute will control the source and volume for the second zone, as connected to the **Multiroom Out Jacks 9**. (See page 31 for complete information on using the Multiroom system.)
- To make it easier to follow the installation instructions that refer to this illustration, a larger copy may be downloaded from the Product Support section at www.harmankardon.com.

H Disc Skip: Press this button to change discs on compatible Harman Kardon CD or DVD changers or players.

I Volume Up/Down: When used in the room where the DPR 1001 is located, press this button to raise or lower the volume in that room. When it is used in a remote room with a sensor that is connected to the **Multiroom IR Jack 3**, this button will raise or lower the volume in the remote room.

J Play Forward/Reverse/Stop: Press these buttons to control compatible Harman Kardon CD, DVD or cassette players.

K Mute: When used in the room where the DPR 1001 is located, press this button to temporarily silence the unit. When it is used in a remote room with a sensor that is connected to the **Multiroom IR Jack 3**, this button will temporarily silence the feed to the remote room only. Press the button again to return to the previous volume level.

INSTALLATION AND CONNECTIONS

System Installation

After unpacking the unit, and placing it on a solid surface capable of supporting its weight, you will need to make the connections to your audio and video equipment.

IMPORTANT NOTE: For your personal safety and to avoid possible damage to your equipment and speakers, it is always a good practice to turn off and unplug the DPR 1001 and ALL source equipment from the AC output before making any audio or video system connections.

Audio Equipment Connections

We recommend that you use high-quality interconnect cables when making connections to source equipment and recorders to preserve the integrity of the signals.

1. Connect the analog output of a CD player to the **CD Inputs 8**.

NOTE: If your CD player has both fixed and variable audio outputs, it is best to use the fixed output unless you find that the input to the receiver is so low that the sound is noisy, or so high that the signal is distorted.

2. Connect the analog Play/Out jacks of a cassette deck, MD, CD-R or other audio recorder to the **Tape Inputs 6**. Connect the analog Record/In jacks on the recorder to the **Tape Outputs 7** on the DPR 1001.
3. Connect the output of any digital sources such as a CD or DVD changer or player, video game, a digital satellite receiver, HDTV tuner or digital cable set-top box or the output of a compatible computer sound card to the **Optical or Coaxial Digital Inputs 30 31 21 23**.
4. Connect the coaxial or optical **Digital Audio Outputs 21** on the rear panel of the DPR 1001 to the matching digital input connections on a CD-R or MiniDisc recorder.
5. Assemble the AM Loop Antenna supplied with the unit so that the tabs at the bottom of the antenna loop snap into the holes in the base. Connect the wires from the **AM** antenna to the **Antenna Terminals 2**. Make certain to connect the wire marked GND to the top terminal screw.

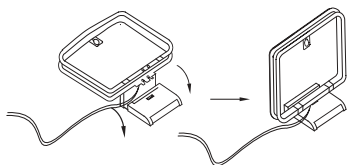

6. Connect the supplied FM antenna to the **FM Antenna (75-ohm) Connection 1**. The FM antenna may be an external roof antenna, an inside powered or wire-lead antenna or a connection from a cable TV system. If the antenna or connection

uses 300-ohm twin-lead cable, you must use an optional 300-ohm-to-75-ohm adapter.

7. Connect the front, center, surround and surround back speaker outputs **22 23 24 25** to the respective speakers.

To ensure that all the audio signals are carried to your speakers without loss of clarity or resolution, we suggest that you use high-quality speaker cable. Many brands of cable are available and the choice of cable may be influenced by the distance between your speakers and the receiver, the type of speakers you use, personal preferences and other factors. Your dealer or installer is a valuable resource to consult in selecting the proper cable.

Regardless of the brand of cable selected, we recommend that you use a cable constructed of multistrand copper with a gauge of 14 or smaller. Remember that in specifying cable, the lower the number, the thicker the cable.

Cable with a gauge of 16 may be used for short runs of less than ten feet. We do not recommend that you use cables with an AWG equivalent of 18 or higher, due to the power loss and degradation in performance that will occur.

Cables that are run inside walls should have the appropriate markings to indicate listing with UL, CSA or other appropriate testing agency standards. Questions about running cables inside walls should be referred to your installer or a licensed electrician who is familiar with the NEC and/or the applicable local building codes in your area.

When connecting wires to the speakers, be certain to observe proper polarity. Note that the positive (+) terminal of each speaker connection now carries a specific color code as noted on page 8. However, most speakers will still use a red terminal for the positive (+) connection. Connect the "negative" or "black" wire to the same terminal on both the receiver and the speaker.

NOTE: While most speaker manufacturers adhere to an industry convention of using black terminals for negative and red ones for positive, some manufacturers may vary from this configuration. To ensure proper phase and optimal performance, consult the identification plate on your speaker or the speaker's manual to verify polarity. If you do not know the polarity of your speaker, ask your dealer for advice before proceeding, or consult the speaker's manufacturer.

We also recommend that the length of cable used to connect speaker pairs be identical. For example, use the same length of cable to connect the front left and front right, surround left and surround right, and surround back left and surround back right speakers, even if the speakers are at different distances from the DPR 1001.

8. Connections to a subwoofer are normally made via a line-level audio connection from the **LFE/Subwoofer Output 29** to the LFE or line-level input of a subwoofer with a built-in amplifier. When a passive subwoofer is used, the connection first goes to a power amplifier, which will be connected to one or more subwoofer speakers. If you are using a powered subwoofer that does not have line-level input connections, follow the instructions furnished with the speaker for connection information.

9. If an external multichannel audio source with 5.1 outputs such as an external digital processor/decoder, DVD-Audio or SACD player is used, connect the outputs of that device to the **6-Channel Direct Inputs 33**.
10. If an external multichannel audio source with 7.1 outputs such as an external digital processor/decoder, DVD-Audio or SACD player is used, first connect the outputs of that device to the **6-Channel Direct Inputs 33**, and then connect the Surround Back Left and Surround Back Right output channels of the source device to the **8-Channel Direct Inputs 34**.

Video Equipment Connections

Video equipment is connected in the same manner as audio components. Again, the use of high-quality interconnect cables is recommended to preserve signal quality.

Although the outputs from any compatible video device may be connected to any video input, to simplify programming device codes into the remote control, we recommend that a hard-drive recorder product such as a TiVo® or ReplayTV® be connected to the **Video 1 Connectors 10 11 12 13**. If there is no hard-drive recorder in your system, connect the VCR to those connectors; otherwise connect it to the **Video 2 Connectors 14 15 16 17**. The audio outputs of your TV should be connected to the **Video 2 Input Connector 15**, and the outputs of a cable box or satellite receiver to the **Video 3 Input Connectors 18 19**.

Note that the DPR 1001 will not convert signals from composite to S-Video, or vice versa. S-Video inputs may only be viewed when the DPR 1001 is connected to a TV set or video display with S-Video capability. If you use both standard composite video and S-Video sources in your system, it is important that you connect both an S-Video cable and a standard composite video cable (a coax cable with an RCA plug on both ends) between the DPR 1001 and your TV or projector. Consult the instructions for your TV set or projector for more information on connecting both types of signals.

1. Connect a VCR's or other video source's audio and video Play/Out jacks to the **Video 1 or Video 2 In**

- Jacks **10 11 14 15** on the rear panel. The Audio and Video Record/In jacks on the VCR should be connected to the **Video 1** or **Video 2 Out Jacks 12 13 16 17** on the DPR 1001.
- Connect the analog audio and video outputs of a television set or any other video source to the **Video 2 Input Jacks 14 15**.
 - Connect the analog audio and video outputs of a satellite receiver, cable TV converter or any other video source to the **Video 3 Jacks 18 19**.
 - Connect the analog audio and video outputs of a DVD or laser disc player to the **DVD Jacks 20 32**. When a digital audio connection is used for your DVD player, the default connection is the **Coaxial 1 Digital Audio Input Jack 30**. However, the connection may also be made to any of the **Optical 31 21** or **Coaxial 30 23** digital audio inputs, provided that the digital input source selection is changed as shown on pages 18 and 27. If your DVD or DVD-Audio player includes an onboard surround decoder and 6- or 8-channel line-level audio outputs, you may connect these audio outputs to the **6- and 8-Channel Direct Inputs 33 34** as appropriate. When you wish to hear this decoded audio, select the DVD input first in order to select the video signal from the DVD player, then select the 6- or 8-Channel Direct Input source for the audio.
 - Connect the digital audio outputs of a DVD player, satellite receiver, cable box or HDTV converter to the appropriate **Optical** or **Coaxial Digital Inputs 30 31 21 23**.
 - Connect the **Video Monitor Output 35** jacks on the receiver to the composite or S-Video input of your television monitor or video projector.
 - If your DVD player and monitor both have component video connections, connect the component outputs of the DVD player to the **DVD Component Video Inputs 37**. Even when component video connections are used, the audio connections should still be made to either the analog **DVD Audio Inputs 20** or any of the **Optical** or **Coaxial Digital Input Jacks 30 31 21 23**.
 - If another component video device is available, connect it to the **Video 2 Component Video Input Jacks 38**. The audio connections for this device should be made to either the **Video 2 Audio Input Jacks 15** or any of the **Optical** or **Coaxial Digital Input Jacks 30 31 21 23**.
 - If the component video inputs are used, connect the **Video Monitor Component Video Outputs 36** to the component video inputs of your TV, projector or display device.

- If you have a camcorder, video game or other audio/video device that is connected to the receiver on a temporary rather than permanent basis, connect the audio, video and digital audio outputs of that device to the **Video 4 Front Panel Inputs 24**. A device connected here is selected as the Video 4 input, and the digital inputs must be assigned to the Video 4 input. (See pages 18 and 27 for more information on input configuration.)

VIDEO CONNECTION NOTES:

- When the component video jacks are used, the on-screen menus are not visible and you must switch to the standard composite or S-Video input on your TV to view them.
- The DPR 1001 will accept either standard composite, S-Video or Y/Pr/Pb component video signals. However, it will not convert composite or S signals to component video.
- Component or composite video signals may only be viewed in their native formats.

System and Power Connections

The DPR 1001 is designed for flexible use with multiroom systems, external control components and power amplifiers.

Main Room Remote Control Extension

If the receiver is placed behind a solid or smoked glass cabinet door, the obstruction may prevent the remote sensor from receiving commands. In this event, an optional remote infrared (IR) sensor may be used. Connect the output of the remote sensor to the **Remote IR Input Jack 5**.

If other components are also prevented from receiving remote commands, only one sensor is needed. Simply use this unit's sensor or a remote eye by running a connection from the **Remote IR Output Jack 4** to the remote IR input jack on Harman Kardon (or other compatible) equipment.

Multiroom IR Link

The remote room IR receiver should be connected to the DPR 1001 via standard coaxial cable. Plug the IR connection cable into the **Multiroom IR Input Jack 3** on the DPR 1001's rear panel.

If other Harman Kardon-compatible source equipment is part of the main room installation, the **Remote IR Output Jack 4** on the rear panel should be connected to the IR IN jack on the source equipment. This will enable the remote room location to control source equipment functions.

NOTE: All remotely controlled components must be linked together in a "daisy chain". Connect the **IR OUT** jack of one unit to the **IR IN** of the next to establish this chain.

Multiroom Audio Connections

Depending on the distance from the DPR 1001 to the remote room, three options are available for audio connection:

Option 1: Run high-quality, shielded audio interconnect cable from the DPR 1001 to the remote room. In the remote room, connect the interconnect cable to a stereo power amplifier. The amplifier will be connected to the room's speakers. At the DPR 1001, plug the audio interconnect cables into the **Multiroom Output Jacks 9** on the DPR 1001's rear panel.

Option 2: Connect the **Multiroom Output Jacks 9** on the DPR 1001 to the inputs of an optional stereo power amplifier that is located with the DPR. Run high-quality speaker wire from the amplifier to the speakers in the remote room.

Option 3: When only a 5.1-channel system is required for the main listening area, the **Surround Back Speaker Outputs 22** may be configured for use in the second zone of a multiroom system. Run high-quality speaker wire from the **Surround Back Speaker Output 22** terminals on the DPR 1001 to the speakers in the remote room. Then, follow the instructions on page 20 for using the DPR 1001's on-screen menu system to configure the **Surround Back Speaker Outputs 22** for operation in the remote room.

NOTE: In all of these options, you may connect an optional IR sensor in the remote room to the DPR 1001 via an appropriate cable. Connect the sensor's cable to the **Multiroom IR Input 3** on the DPR 1001 and use the Zone II remote to control the room volume. Alternatively, you may install an optional volume control between the output of the amplifier or **Surround Back Speaker Outputs 22** and the speakers.

AC Power Connections

This unit is equipped with two **AC Accessory Outlets 26**. They may be used to power accessory devices, but they should not be used with high-current draw equipment such as power amplifiers. The total power draw for both outlets may not exceed 100 watts.

The top outlet is unswitched, which means that power is available as long as the DPR is plugged in.

The bottom outlet is switched, which means that power is supplied only when the DPR is turned on. Since the power is removed when the DPR is turned off, this outlet should not be used for devices such as VCRs where a constant power source is required for a clock or timer, or for products that do not have a mechanical power switch and thus turn off when AC power is removed.

Finally, when all connections are complete, plug the power cord into a nonswitched AC wall outlet. You're almost ready to enjoy the DPR 1001!

SYSTEM CONFIGURATION

When all audio, video and system connections have been made, there are a few configuration adjustments that must be made. A few minutes spent to correctly configure and calibrate the unit will greatly add to your listening experience.

Speaker Selection and Placement

The placement of speakers in a multichannel home theater system can have a noticeable impact on the quality of sound reproduced.

No matter which type or brand of speakers is used, the same model or brand of speaker should be used for the left front, center and right front speakers. This creates a seamless front soundstage and eliminates the possibility of distracting sonic disturbances that occur when a sound moves across mismatched front channel speakers.

Speaker Placement

Depending on the type of center channel speaker in use and your viewing device, place the center speaker either directly above or below your TV, or in the center behind a perforated front projection screen.

Once the center channel speaker is installed, position the front left and front right speakers so that they are as far away from one another as the center channel speaker is from the preferred listening position. Ideally, the front channel speakers should be placed so that their tweeters are no more than 24" above or below the tweeter in the center channel speaker.

Depending on the specifics of your room acoustics and the type of speakers in use, you may find that imaging is improved by moving the left front and right front speakers slightly forward of the center channel speaker. If possible, adjust all front loudspeakers so that they are aimed at ear height when you are seated in the listening position.

Using these guidelines, you'll find that it takes some experimentation to find the correct location for the front speakers in your particular installation. Don't be afraid to move things around until the system sounds correct. Optimize your speakers so that audio transitions across the front of the room sound smooth, and that sounds from all speakers appear to arrive at the listening position at the same time (without delay from the center speaker compared to the left and right speakers).

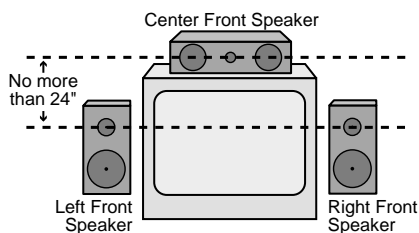

A) Front channel speaker installation with direct-view TV sets or rear-screen projectors

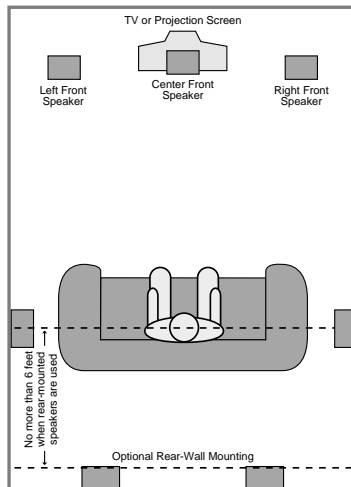

B) Rear speaker mounting is an alternate location for 5.1 systems. It is required for 7.1 operation.

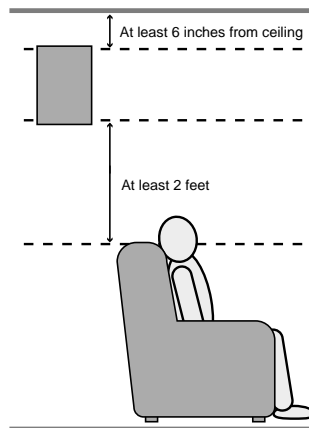

When the DPR 1001 is used in 5.1-channel operation, the preferred location for surround speakers is on the side walls of the room, at or slightly behind the listening position. In a 7.1-channel system, both side surround and back surround speakers are required. The center of the speaker should face into the room. The speakers should be located so that the bottom of the cabinet is at least two feet higher than the listeners' ears when the listeners are seated in the desired area.

Rear surround speakers are required when a full 7.1-channel system is installed, and they may also be used as an alternative mounting position in a 5.1-channel system when it is not practical to place the main surround speakers on the sides of the room. Speakers may be placed on a rear wall, behind the listening position.

As with the side speakers, rear surrounds should be located so that the bottom of the cabinet is at least two feet higher than the listeners' ears. The speakers should be no more than six feet behind the rear of the seating area.

Subwoofers produce nondirectional sound, so they may be placed almost anywhere in a room. Actual placement should be based on room size and shape and the type of subwoofer used. One method of finding the optimal location for a subwoofer is to begin by placing it in the front of the room, about six inches from a wall, or near the front corner of the room. Another method is to temporarily place the subwoofer at your normal listening position, and then walk around the room until you find a spot where the subwoofer sounds best. Place the subwoofer in that spot. You should also follow the instructions of the subwoofer's manufacturer, or you may wish to experiment with the best location for a subwoofer in your listening room.

System Setup

Once the speakers have been placed in the room and connected, the remaining steps in the setup process are to program the DPR 1001's bass management system for the type of speakers used in your system, calibrate the output levels, and set the delay times used by the surround sound processor.

You are now ready to power up the DPR 1001 to begin these final adjustments.

1. Plug the **AC Power Cord 27** into an unswitched AC outlet.
2. Open the door on the lower right corner of the front panel to reveal the **Main Power Switch 19** and the other front panel jacks by gently pulling the door down from the side of the unit where the word **OPEN** appears. Press the **Main Power Switch 19** in until it latches. Note that the **Power Indicator 1** will turn red, indicating that the unit is in the Standby mode.
3. Remove the protective plastic film from the front panel lens. If left in place, the film may affect the performance of your remote control.
4. Install the four supplied AAA batteries in the remote as shown. Be certain to follow the (+) and (-) polarity indicators that are printed inside the battery compartment.

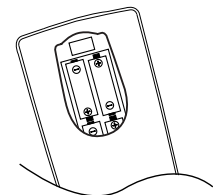

5. Turn the DPR 1001 on either by pressing the **Standby/On Button 2** on the front panel, or via the remote by pressing the **Power On Button 2**, the **AVR Selector 5** or any of the **Input Selectors 4, 34, 43** on the remote. The **Power Indicator 1** will turn green to confirm that the unit is on, and the **Main Information Display 16** will also light.

Using the On-Screen Display

When making the following adjustments, you may find it easier to use the DPR 1001's on-screen display system. These easy-to-read displays give you a clear picture of the current status of the unit and make it easy to see which speaker, delay, input or digital selection you are making.

To view the on-screen menus, make certain you have made a connection from the **Video Monitor Out Jack 35** on the rear panel to the composite or S-Video input of your TV or projector. In order to view the DPR 1001's displays, the correct video source must be selected on the video display. Note that the on-screen menus are not available when a component video display is in use.

IMPORTANT NOTE: When viewing the on-screen menus using a CRT-based projector, plasma display or any direct-view CRT monitor or television, it is important that they not be left on the screen for an extended period of time. The constant display of a static image such as these menus or video game images may cause the image to be permanently "burned into" the projection tubes, plasma screen or CRT. This type of damage is not covered by the DPR 1001 warranty and may not be covered by the projector/TV set's warranty.

The DPR 1001 has two on-screen display modes, "Semi-OSD" and "Full-OSD." When making configuration adjustments, it is recommended that the Full-OSD mode be used. This will place an option listing on the screen, making it easier to view the available options.

Making Configuration Adjustments

The full-OSD system is available by pressing the **OSD Button 31**. When this button is pressed, the **MAIN** menu (Figure 1) will appear, and adjustments are made from the individual menus.

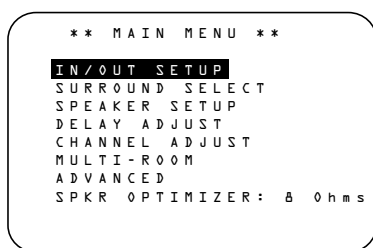

Figure 1

The semi-OSD system is also available, allowing you to make adjustments directly, by pressing the appropriate buttons on the front panel or remote control for the specific parameter to be adjusted. For example, to change the digital input for any of the sources, press the **Digital Select Button 15** on the remote, or use the front panel buttons following the instructions shown on page 18.

To use the full-OSD menu system, press the **OSD Button 31**. When the menu is on the screen, press the **▲/▼ Navigation Buttons 14** until the item you wish to adjust is highlighted in a white box and then press the **Set Button 16** to adjust that item. The menus will remain on the screen for 20 seconds, and then they will "time-out" and disappear from the screen. The time-out may be increased to as much as 50 seconds by going to the **ADVANCED SELECT** menu, and changing the item titled **FULL OSD TIME OUT** (see page 31).

When the full-OSD system is in use, the menu selections are not shown in the **Main Information Display 16**. When the full-OSD menu system is used, **OSD ON** will appear in the **Upper Display Line F** and the **OSD Indicator D** will light to remind you that a video display must be used. When the semi-OSD system is used in conjunction with the discrete configuration buttons, the on-screen display will show the current menu selection. That selection will also be shown in the **Lower Display Line B**.

Speaker Optimizer

The Speaker Optimization function is critical to ensure optimal performance of the DPR. This setting tells the digital amplifier section which settings to use to best match its operation to your specific speakers. Note that this adjustment is electronic, not electrical, and unlike the "8-ohm/4-ohm" switches on older analog amplifiers, you do not need to turn the DPR off to change the setting. However, we do suggest that you do not have any program material playing through the DPR when the setting is changed.

Before making this adjustment you will need to find the impedance specification for your speakers. This information is often found on a label attached to the speaker, and it is usually shown in the owner's manual that came with your speakers. If you cannot find the information for your speakers, consult the manufacturer's Web site or customer service department.

In cases where the speakers in a system have different impedance ratings, such as 8 ohms for the front left/right and center speakers and 6 ohms for the surround speakers, use the setting for the front speakers, as they are used most often for all types of program material.

If you cannot determine the speaker's impedance, there is no harm in using the factory default setting of 8 ohms, as most home speakers are in that range.

Since the factory default is 8 ohms, you may skip this section if that is the setting appropriate to your system. If you do want to change the setting, follow these steps.

Press the **OSD Button 31** so that the **MAIN** menu (Figure 1) appears on your display. Press the **▼ Navigation Button 14** so that **SPKR**

OPTIMIZER is highlighted and then press the **◀▶ Navigation Buttons 14** until the desired setting appears.

When the correct impedance figure is on the screen, press the **▼ Navigation Button 14** so that **IN/OUT SETUP** is highlighted and proceed to the following section to configure the remaining settings for your DPR.

Setting the System Configuration Memory

The DPR 1001 features an advanced memory system that enables you to establish different configurations for the speaker configuration, digital input, surround mode, crossover frequency and output levels for each input source. This flexibility enables you to custom-tailor the way in which you listen to each source and have the DPR 1001 memorize those settings. This means, for example, that you may use different output levels or trims for different sources, or set different speaker configurations with the resultant changes to the bass management system. Once these settings are made, they will automatically be recalled whenever you select that input.

The factory default settings for the DPR 1001 have all inputs except for DVD configured for an analog audio input; for the DVD input, the **Coaxial 1 Digital Input 30** is the default. The default speaker settings are "SMALL" for all speaker positions, and for the Subwoofer to be on. The default setting for the surround modes is Logic 7 Music, although Dolby Digital or DTS will automatically be selected as appropriate when a source with digital encoding is in use.

Before using the unit, you will probably want to change the settings for most inputs so that they are properly configured to reflect the use of digital or analog inputs, the type of speakers installed and the surround mode specifics of your home theater system. Remember that since the DPR 1001 memorizes the settings for each input individually, you will need to make these adjustments for each input used. However, once they are made, further adjustment is only required when system components are changed.

To make this process as quick and as easy as possible, we suggest that you use the full-OSD system with the on-screen menus, and step through each input. Once you have completed the settings for the first input, many settings may be duplicated for the remaining inputs. It is also a good idea to set the configuration data in the order these items are listed in the **MAIN** menu, as some settings require a specific entry in a prior menu item. Remember that once the settings are made for one input, they must be made for all other input sources in your system.

SYSTEM CONFIGURATION

Input Setup

The first step in configuring the DPR 1001 is to configure each input. When using the full-OSD system to make the setup adjustments, press the **OSD Button 31** once so that the **MAIN** menu (Figure 1) appears. The **IN/OUT SETUP** line will be highlighted. Press the **Set Button 16** to enter the menu and the **IN/OUT SETUP** menu (Figure 2) will appear on the screen. Press the **Navigation Buttons 14** until the desired input name appears, as well as being indicated in the front panel **Input Indicators 17** by the amber LED next to the desired input name. If the input will use the standard left/right analog inputs, no further adjustment is needed.

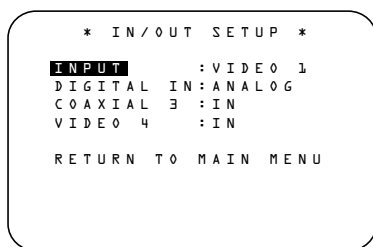

Figure 2

If you wish to associate one of the digital inputs with the selected input source, press the **Navigation Button 14** while the **IN/OUT SETUP** menu (Figure 2) is on the screen, and the **DIGITAL IN** line will be highlighted in reverse text. Press the **Navigation Buttons 14** until the name of the desired digital input appears. To return to the analog input, press the buttons until the word **ANALOG** appears. When the correct input source appears, press the **Navigation Button 14** once so that **RETURN TO MAIN MENU** is highlighted, and press the **Set Button 16**.

To change the digital input at any time using the remote control and the semi-OSD system, press the **Digital Select Button 15**. Within five seconds, make your input selection using the **Navigation Buttons 14** until the desired digital or analog input is shown in the **Upper Display Line F** and in the video display connected to the DPR 1001. Press the **Set Button 16** to enter the new digital input assignment.

To change the digital input from the front panel, press the **Set Button 11** and then press the **Navigation Buttons 10/12** until the amber LED is next to **DIGITAL SELECT** in the **System Configuration Indicators 15** on the right side of the front panel and **DIGI SEL MODE** appears in the **Lower Display Line B**. Within five seconds, press the **Set Button 11** again, and then press the **Navigation Buttons 10/12** again to cycle through the list of available inputs. When the desired digital input (or the analog input) name flashes in the right portion of the message in the **Upper Display Line F** and in the on-screen display, press the **Set Button 11** to enter your choice into

the unit's memory. The DPR 1001 will return to normal operation and displays within five seconds.

NOTE: When a source such as an HDTV receiver or a digital cable set-top box is used, you may wish to connect both the coaxial digital output and the standard, analog output of the source to the DPR's VID 2 input since the program sources and channels received by these devices often switch between analog and digital audio.

An exclusive Harman Kardon feature is the ability to switch the front panel coaxial digital audio and analog audio/video jacks from their normal use as inputs to output connections so that portable recording devices may easily be connected. On the DPR 1001, the **Digital Coax 3 Jack 23** is normally an input, but it may be switched to a digital output for use with CD-R/RW decks, MD recorders or other A/V recorders. To change the jack to an output, press the **Navigation Buttons 14** while the **IN/OUT SETUP** menu is on the screen until **COAXIAL 3** is highlighted. Then press the **Navigation Buttons 14** so that the word **OUT** appears. The **Input/Output Status Indicator 22** will turn red, indicating that the jack is now a record output.

NOTE: A signal will be sent to this jack only when the input selected for use by the DPR 1001 is digital. Digital signals will be passed through regardless of their format, and which digital input (optical or coax) they are fed from. However, analog signals are not converted to digital, and the signal's format (e.g., PCM, Dolby Digital or DTS) may not be changed.

Selection of the front panel jacks as an output will remain effective as long as the DPR 1001 is on. Once the unit is turned off, the jacks will revert to their normal use as an input when the unit is turned on again.

The front panel analog **Video 4 Jacks 24** are normally set as an input for use with camcorders, video games and other portable audio/video products, but they may be switched to an output for connection to portable audio/video recorders. To temporarily switch them to outputs, you must first be at the **IN/OUT SETUP** menu. Press the **Navigation Button 14** until the **VIDEO 4** line is highlighted. Press the **Navigation Button 14** so that the word **OUT** appears. Note that the **Input/Output Status Indicator 22** between the S- and composite video jacks will turn red, indicating that the analog Video 4 jacks are now record outputs.

Surround Setup

Once the basic input setup has been completed, the next step is to select the surround mode you wish to use with an input. Since surround modes are a matter of personal taste, feel free to select any mode you wish – you may change it later. However, to make it easier to establish the initial parameters for the DPR 1001, it is best to select Dolby Pro Logic II or Logic 7 for most analog inputs and Dolby Digital for inputs connected to digital

sources. In the case of inputs such as a CD Player, Tape Deck or Tuner, you may wish to set the mode to Stereo ("Surround Off") as they are not typically used with surround-encoded material. Alternatively, the Logic 7 Music mode is a good choice for two-channel source material.

It is easiest to complete the surround setup using the full-OSD on-screen menus. From the **MAIN** menu (Figure 1), press the **Navigation Buttons 14** until **SURROUND SELECT** is highlighted. Press the **Set Button 16** so that the **SURROUND SELECT** menu (Figure 3) is on the screen.

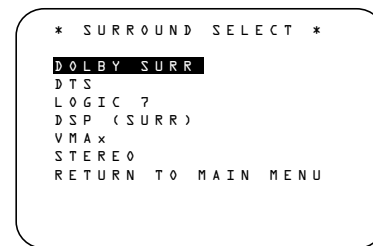

Figure 3

Each of the lines on the menu (Figure 3) contains a category menu surround mode and within those menus you may choose one of the sub-modes. The list of sub-modes in some categories will vary according to whether 5.1 or 6.1/7.1 operation is chosen. Also, some of the modes available in the DPR 1001 will not appear unless a digital source is selected and playing the correct bitstream.

The selection of 5.1 or 6.1/7.1 configuration is determined by the setting for Surround Back Speakers in the Speaker Setup menu. The factory setting is for "None," which will mean that only 5.1 modes will be available. To utilize the 6.1/7.1 surround modes, change the setting for the Surround Back Speakers to either Large or Small, as shown in the instructions on page 20. This will automatically activate all 6.1/7.1 surround mode options.

To select the mode that will be used as the initial default for an input, first press the **Navigation Buttons 14** until the on-screen cursor is next to the desired mode's master category name. Next, press the **Set Button 16** to view the sub-menu. Press the **Navigation Buttons 14** to scroll through the available choices, and then press the **Navigation Button 14** so that the cursor is next to **RETURN TO MAIN MENU** to continue the setup process.

On the **DOLBY SURR** menu (Figure 4), the choices include Dolby Digital, Dolby Pro Logic II Music, Dolby Pro Logic II Movie, Dolby Pro Logic and Dolby 3 Stereo. When a 6.1/7.1 speaker configuration is used, Dolby Digital EX replaces the Dolby Digital mode. For a complete explanation of these modes, see page 26. Note that when a Dolby Digital mode is selected there are additional settings available for the Night mode.

Note also that some of the available surround mode combinations include both Dolby Digital and the various

options for Dolby Pro Logic II. These are used with DVD or other Dolby Digital sources such as digital cable or some high-definition television programs where Dolby Digital is used to carry the soundtrack, but the soundtrack itself is only two-channel stereo. Check the Dolby Digital icon information on the back of a DVD or the program listings for your cable, satellite or HDTV station to see whether the programming is Dolby Digital 5.1 or 2.0. When the DPR 1001 detects a Dolby Digital 2.0 signal, it will automatically default to the Dolby Pro Logic surround mode.

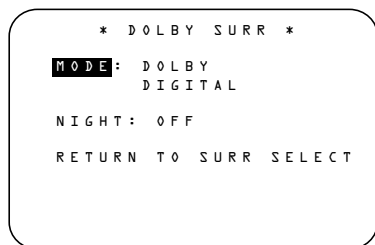

Figure 4

The Night mode is a feature of Dolby Digital that uses special processing to preserve the dynamic range and full intelligibility of a movie sound track while reducing the peak level. This prevents abruptly loud transitions from disturbing others, without reducing the sonic impact of a digital source. The Night mode is only available when specially encoded Dolby Digital signals are played.

To adjust the Night mode setting for an input from the menu, make certain that the **NIGHT** line of the **DOLBY SURR** menu (Figure 4) is highlighted.

Next, press the **Navigation Buttons** **14** to choose between the following settings, as they appear in the on-screen display:

OFF: When **OFF** appears, the Night mode will not function.

MID: When **MID** appears, a mild compression will be applied.

MAX: When **MAX** appears, a more severe compression algorithm will be applied.

We recommend the **MID** setting as a starting point and the **MAX** setting as an alternative.

The Night mode may be adjusted directly any time that a Dolby Digital source is playing by pressing the **Night Mode Button** **30**. When the button is pressed, the phrase **D-RANGE** will appear in the lower third of the video screen and in the **Lower Display Line** **B**. Press the **Navigation Button** **14** within three seconds to select the desired setting.

On the **DTS** menu, the choices made are determined by a combination of the type of DTS program material in use and whether the 5.1 or 6.1/7.1 speaker output configuration is in use. When either of the speaker configurations is in use, you may select either the Neo:6 Music or Neo:6 Cinema mode to deliver an enhanced

5.1- or 6.1-channel sound field.

When a 5.1 speaker configuration is in use, the DPR will automatically select the 5.1 version of DTS processing when a DTS data stream is selected. When a 6.1/7.1 speaker configuration is in use, the DTS-ES Discrete mode will automatically be activated when a DTS source with the ES Discrete "flag" is in use. When a non-ES DTS disc is in use, you may select the DTS-ES Matrix mode through this menu to create a full eight-speaker surround mode. See page 26 for a complete explanation of the DTS modes.

On the **LOGIC 7** menu, the choices are determined by whether the 5.1 or 6.1/7.1 speaker output configuration is in use. In either case, the selection of a Logic 7 mode enables Harman Kardon's exclusive Logic 7 processing to create fully enveloping, multi-channel surround from either two-channel Stereo or Matrix-encoded programming such as VHS cassettes, laser discs or television broadcasts produced with Dolby surround.

With a 5.1 speaker configuration, you may select the Logic 7/5.1 Music, Cinema or Enhance modes. They work best with two-channel music, surround-encoded programs or standard two-channel programming of any type, respectively. When a 6.1/7.1 speaker configuration is in use, only the Music and Cinema modes are available, and the output will be in a full eight-channel sound field. Note that the Logic 7 modes are not available when either Dolby Digital or DTS Digital soundtracks are in use. See page 26 for a complete explanation of the Logic 7 Surround modes.

On the **DSP** menu, the choices are the DSP surround modes designed for use with two-channel stereo programs to create a variety of sound field presentations. The choices available are Hall 1, Hall 2 or Theater. See page 26 for a complete explanation of the DSP surround modes.

On the **VMAx** menu, the choices are one of two VMAx modes, designed to deliver a 360-degree sound field when only the front left and right speakers are installed. See page 26 for a complete explanation of the VMAx modes.

On the **STEREO** menu, the choices will either turn the surround processing off for a traditional two-channel stereo presentation, or select **5 STEREO** or **7 STEREO** depending on whether a 5.1 or 6.1/7.1 configuration is in use. The latter modes feed a two-channel presentation to all speakers, regardless of the number of speakers in use. See page 26 for a complete explanation of the 5 Stereo and 7 Stereo modes.

After the selections are made on the Dolby, DTS, Logic 7, DSP or Stereo menus, press the **Navigation Buttons** **14** so that the cursor moves to the **RETURN TO SURR SELECT** line and press the **Set Button** **16**. In the **SURROUND SELECT** menu use the **Navigation Buttons**

14 to highlight the **RETURN TO MAIN MENU** option, and press the **Set Button** **16** to return to the **MAIN** menu.

Speaker Setup

This menu tells the DPR 1001 which type of speakers are in use. This is important as it adjusts the settings that decide whether your system will use the "5-channel" or "6-channel/7-channel" modes, as well as determining which speakers receive low-frequency (bass) information.

For each of these settings, use the **LARGE** setting if the speakers for a particular position are traditional full-range loudspeakers. Use the **SMALL** setting for smaller, frequency-limited satellite speakers that do not reproduce sounds below 200Hz. Note that when "small" speakers are used, a subwoofer is required to reproduce low-frequency sounds. Remember that the "large" and "small" descriptions do not refer to the actual physical size of the speakers, but to their ability to reproduce low-frequency sounds. If you are in doubt as to which category describes your speakers, consult the specifications in the speakers' owner's manual, or ask your dealer.

This menu screen also allows you to enter the settings for the DPR 1001's Triple Crossover feature that allows a different crossover point to be used for the front left/right, center and surround speakers. In systems where full-range or tower speakers are used for the front soundstage or where different brands or models are in use at the various speaker positions, this feature allows you to customize the bass management circuits with a precision not previously possible.

It is easiest to enter the proper settings for the speaker setup through the **SPEAKER SETUP** menu (Figure 5). If that menu is not already on your screen from the prior adjustments, press the **OSD Button** **31** to bring up the **MAIN MENU** (Figure 1), and then press the **Navigation Button** **14** until the cursor is on the **SPEAKER SETUP** line. At this point, press the **Set Button** **16** to bring up the **SPEAKER SETUP** menu (Figure 5).

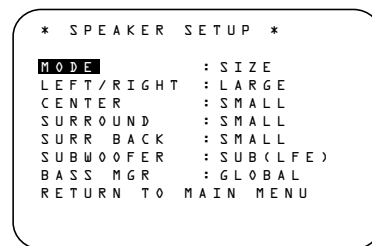

Figure 5

The first line of the **SPEAKER SETUP** menu (Figure 5) allows you to switch the menu to change either the underlying speaker size setting or the exact crossover point used for that speaker group. For the first pass through the menu, leave the setting at its default

SYSTEM CONFIGURATION

option of **SIZE**, and then proceed as outlined below. Once the speaker choices have been set you may wish to return to this line to change the option so that the crossover settings may be adjusted.

Begin the speaker setup process by making certain that the **LEFT/RIGHT** line is highlighted in reverse video, which sets the configuration for the front left and right speakers. If you wish to make a change to the front speakers' configuration, press the ◀▶ **Navigation Buttons 14** so that either **LARGE** or **SMALL** appears, matching the appropriate description from the definitions on page 19.

When **SMALL** is selected, low-frequency sounds will be sent only to the subwoofer output. If you choose this option and there is no subwoofer connected, you will not hear any low-frequency sounds from the front channels.

When **LARGE** is selected, a full-range output will be sent to the front left and front right outputs. Depending on the choice made in the **SUBWOOFER** line in this menu, bass information may also be directed to the front left/right speakers, a subwoofer or both.

NOTE: When the front speakers are set to the **LARGE** option and the surround mode is set to "Surround Off," or pure two-channel stereo, when an analog signal source is present it will be routed directly from the input to the volume control without being digitized or processed. If you have full-range front speakers and wish to remove all digital processing from the circuit path, select this configuration. If you wish to set this option for use with only one input, such as a CD player that uses an external DAC or an optional, external phono preamp, you may also wish to choose the **INDEPENDENT** setting on the **BASS MGR** line at the bottom of this menu so that only those inputs where the analog bypass is desired will be routed in this fashion, while other analog inputs such as a VCR or cable box will be digitized for surround processing.

When you have completed your selection for the front channel, press the ▼ **Navigation Button 14** to move the highlighted video to **CENTER**.

Press the ◀▶ **Navigation Buttons 14** to select the option that best describes your system, based on the definitions shown on page 19.

When **SMALL** is selected, low-frequency center channel sounds will be sent only to the subwoofer output. If you choose this option and there is no subwoofer connected, you will not hear low-frequency sounds from the center channel.

When **LARGE** is selected, a full-range output will be sent to the center speaker output, and NO center channel signal will be sent to the subwoofer output.

NOTE: If you choose Logic 7 as the surround mode for

the particular input source for which you are configuring your speakers, the DPR 1001 will not make the **LARGE** option available for the center speaker. This is due to the requirements of Logic 7 processing, and does not indicate a problem with your receiver.

When **NONE** is selected, no signals will be sent to the center channel output. The receiver will operate in a "phantom" center channel mode and center channel information will be sent to the left and right front channel outputs. When only front left and right speakers are used, with no center or surround speakers, VMAx is a good alternative mode.

When you have completed your selection for the center channel, press the ▼ **Navigation Button 14** to move the highlighted video to **SURROUND**.

Press the ◀▶ **Navigation Buttons 14** to select the option that best describes the surround speakers in your system based on the definitions shown on page 19.

When **SMALL** is selected, low-frequency surround channel sounds will be sent to the subwoofer output only. If you choose this option and there is no subwoofer connected, you will not hear any low-frequency sounds from the surround channel.

When **LARGE** is selected, a full-range output will be sent to the surround channel outputs, and NO surround channel signals will be sent to the subwoofer output.

When **NONE** is selected, surround sound information will be split between the front left and front right outputs.

When you have completed your selections for the main surround channels, press the ▼ **Navigation Button 14** to move the highlighted video to **SURR BACK**. This line enters the setting for the surround back channels when they are present, and it also tells the DPR 1001's processing system to configure the unit for either 5.1 or 6.1/7.1 operation.

Press the ◀▶ **Navigation Buttons 14** to select the option that best describes the speakers in use at the left and right back surround positions based on the definitions on page 19.

When **NONE** is selected, the system will adjust so that only 5.1-channel surround modes are available and the surround back amplifier channels will not be used. When this is the case for your system you may wish to take advantage of the availability of this amplifier channel pair for use in powering a second set of speakers that have their source selected by the DPR 1001's multiroom control system. See pages 15 and 31 for more information.

When **SMALL** is selected the system will adjust so that the full complement of 6.1/7.1 surround modes is available, and low-frequency information below the crossover point will be sent to the subwoofer output. If you choose this option with no subwoofer connected,

you will not hear low-frequency sounds from the surround back channel.

When **LARGE** is selected the system will adjust so that the full complement of 6.1/7.1 surround modes is available, and a full-range signal will be sent to the surround back channels, with no low-frequency information sent to the subwoofer output.

When you have completed your selection for the back surround channels, press the ▼ **Navigation Button 14** on the remote to move the highlighted video to **SUBWOOFER**.

Press the ◀▶ **Navigation Buttons 14** to select the option that best describes your system.

The choices available for the subwoofer position will depend on the settings for the other speakers, particularly the front left/right positions.

If the front left/right speakers are set to **SMALL**, the subwoofer will automatically be set to **SUB**.

If the front left/right speakers are set to **LARGE**, three options are available:

- If no subwoofer is connected, press the ◀▶ **Navigation Buttons 14** so that **SUB NONE** appears in the on-screen menu. When this option is selected, all bass information will be routed to the front left/right "main" speakers.
- If a subwoofer is connected, you have the option to have the front left/right "main" speakers reproduce bass frequencies at all times, and have the subwoofer operate only when a digital source with a dedicated Low-Frequency Effects, or LFE, soundtrack is in use. This allows you to use both your main and subwoofer speakers to take advantage of the bass created for certain movies. Press the ◀▶ **Navigation Buttons 14** so that **LFE** appears in the on-screen menu for this option.
- To use a subwoofer for bass reproduction in conjunction with the main front left/right speakers, regardless of the type of program source or Surround mode you are listening to, press the ◀▶ **Navigation Buttons 14** so that **L/R+LFE** appears. When this option is selected, a full-range signal will be sent to the front left/right "main" speakers, and the subwoofer will receive the bass frequencies under frequency selected, as described below.

When all initial speaker "size" settings have been made, you may then take advantage of the DPR 1001's Triple Crossover system, which allows individual crossover settings to be made for each speaker grouping. The low-frequency crossover point is set by the design of your speakers. Depending on the design and driver complement of your speakers, it is defined as the frequency which is either the lowest possible frequency the speaker

is capable of reproducing, or the frequency at which sound is sent to the speaker's internal low-frequency driver, as opposed to the mid-range driver. Before making any changes to the settings for the crossover point we suggest that you find the crossover point for the speakers in each of the three groupings, front left/right, center front and surrounds by looking at the specifications page of the speaker's owner's manual, by getting that information from the manufacturer's Web site, or by contacting your dealer or the manufacturer's customer service department. You will need this data to accurately configure the next group of settings.

The factory default setting for all speaker positions is 100Hz. If that setting is acceptable for all channels, no adjustments are needed and you may skip this section. To change one of the settings, press the **▲ Navigation Button 14** so that the cursor moves back up to the top of the list of setting options. Press the **◀▶ Navigation Buttons 14** so that **X-OVER** is highlighted and the menu will change to the screen shown in Figure 6.

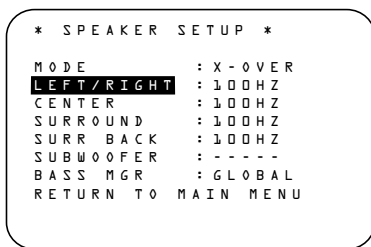

Figure 6

To change the setting for any of the three speaker groups, press the **▲/▼ Navigation Buttons 14** until the cursor is next to the line where you wish to make a change and then press the **◀▶ Navigation Buttons 14** until the desired setting appears. The available choices at which point low-frequency information will be sent to the subwoofer, rather than to the main speaker channel, are 40Hz, 60Hz, 80Hz, 100Hz, 120Hz and 200Hz. Pick the choice that is identical to the information for the speakers, or if an exact match is not possible, pick the closest choice that is ABOVE the speaker's low-frequency limit or crossover point to avoid the creation of a low-frequency "hole" where your system will have no bass information.

In cases where **LARGE** has been selected as the front channel speaker option and **L/R+LFE** has been selected as the subwoofer option, the front channel sound information below the setting shown will be sent to BOTH the front channel speakers and the subwoofer.

The subwoofer's crossover point will automatically adjust to meet the setting for each speaker grouping so that no bass information will be lost.

When all crossover settings have been made, or in

those cases where none are needed, press the **▼ Navigation Button 14** so that the **BASS MGR** line is highlighted.

This setting allows you to use the same speaker configuration and crossover settings for all inputs, or to have different settings for each input. In most cases the factory default setting of **GLOBAL** will be appropriate, as most listeners do not need to have individualized speaker settings. However, some listeners, particularly those with full-range front speakers that are used for both movies and music may prefer that different crossover points be used when listening to music through a CD player as opposed to a movie from a DVD player, VCR or cable/satellite set top box.

If you wish to customize the crossovers to each input, make certain that the **BASS MGR** line is highlighted and press the **◀▶ Navigation Buttons 14** so that **INDIVIDUAL** appears. When this setting is stored by exiting the menu, the configuration settings just entered will apply to the current input ONLY, and you will need to go back to the **IN/OUT SETUP** menu to select another input, and then return to this menu page again to change the settings for the next input. Repeat the procedure for any input where you wish to have a different set of speaker configuration and crossover settings.

When all speaker selections have been made, press the **▼ Navigation Button 14** and then the **Set Button 16** to return to the **MAIN** menu.

Delay Settings

If Dolby Digital, Dolby Pro Logic or DTS is selected as the surround mode for an input, you may need to adjust the delay time setting. The delay time is not adjustable for any other modes.

Due to the different distances between the listening position for the front-channel speakers and the surround speakers, the amount of time it takes for sound to reach your ears from the front versus surround speakers differs. You may compensate for this difference through the use of the delay settings to adjust the timing for the speaker placement and acoustic conditions in your listening room or home theater.

The factory setting is appropriate for most rooms, but some installations create an uncommon distance between the front and surround speakers that may cause the arrival of front-channel sounds to become disconnected from surround-channel sounds.

To set the delay time for a specific input, the **DELAY ADJUST** menu (Figure 7) should be visible in your on-screen display. If the system is not already at that point, press the **OSD Button 31** to bring up the **MAIN** menu, press the **▼ Navigation Button 14** until the **DELAY ADJUST** line is highlighted. Press the **Set Button 16** to call up the menu.

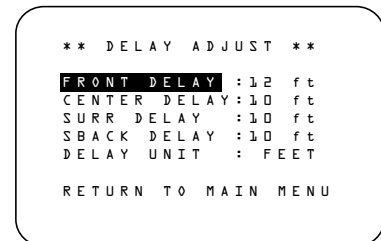

Figure 7

When the **DELAY ADJUST** menu appears, note that the default setting uses the distance from the speakers to the prime listening position in feet as the means by which the delay settings are calculated. We suggest that you use those distances, and proceed to the next step. However, you may also enter the distances in meters. To use that alternative method, first press the **▼ Navigation Buttons 14** until the **DELAY UNIT** line is highlighted in reverse video. Press the **◀▶ Navigation Buttons 14** to select the desired entry mode of FEET or METERS. After the choice of data entry method has been made, press the **▲ Navigation Button 14** twice to highlight the **FRONT DELAY** line.

With the **FRONT DELAY** line highlighted in reverse video, press the **◀▶ Navigation Buttons 14** until the distance from the front left/right speakers to the prime listening position is entered in either feet or meters, depending on which unit of measurement has been selected.

Once the Front Delay has been set, press the **▼ Navigation Button 14** once so that **CENTER DELAY** is highlighted in reverse video. Press the **◀▶ Navigation Buttons 14** until the distance from the center speaker to the prime listening position is entered in either feet or meters, depending on which unit of measurement has been selected.

NOTE: The Center Delay setting may only be made if the Dolby Digital or Dolby Digital EX mode has been selected, and the center channel speaker has been configured for either Small or Large. If you cannot adjust the center channel delay, check to make certain that these settings have been established in the Surround Select and Speaker Setup menus.

When the speaker-to-listening position distance or a specific delay time setting has been entered for the front and center speakers, press the **▼ Navigation Button 14** to highlight either the Surround (SURR) or Surround Back (SBACK) speakers and make any adjustments needed to enter the correct distance from those speakers to the listening position. Press the **Set Button 16** when the desired speaker pair is highlighted, and make the adjustments as shown above.

You may also change the delay time settings at any time from either the remote control or the front panel.

SYSTEM CONFIGURATION

To change the delay time settings from the remote control, press the **Delay Select Button 36**. **FRONT DELAY** will appear in the bottom line of the on-screen display as well as in the **Lower Display Line B**. Next, press the **▲/▼ Navigation Buttons 14** to select the desired speaker delay adjustment and then press the **Set Button 16**. Press the **▲/▼ Navigation Buttons 14** to enter the speaker-to-listening position distance for the speaker position being adjusted. When the desired setting appears, press the **Set Button 16** to enter the setting. To adjust another delay parameter, repeat the procedure outlined above. When all desired settings have been made, simply wait five seconds and the unit will return to normal operation.

To change the delay settings from the front panel, press the **Set Button 11** and then press the **▲/▼ Navigation Buttons 10/12** until the amber LED is next to **DELAY** in the **System Configuration Indicators 15** on the right side of the front panel and **DELAY MODE** appears in the **Lower Display Line B** and on-screen display. Within five seconds, press the **Set Button 11**; **FRONT DELAY** will now appear in the displays. If an adjustment is required, press the **Set Button 11** again, and then press the **▲/▼ Navigation Buttons 10/12** again to enter the speaker-to-listening position distance. When the desired speaker configuration has been selected, press the **Set Button 11** to enter the setting and then repeat this procedure to select another speaker group if required. When all settings are complete, the DPR 1001 will return to normal operation and displays within five seconds.

OPERATIONAL NOTE: When making adjustments to the delay time using the front panel or remote control for data entry, the unit of measurement will be the same as the last settings made using the OSD menu system. To change the unit of measurement used for the front panel or remote control adjustments, you must first make a change at the **DELAY UNIT** line of the **DELAY ADJUST** menu.

Output Level Adjustment

Output level adjustment is a key part of the configuration of any surround-sound product. It is particularly important for a digital receiver such as the DPR 1001, as correct outputs ensure that you hear sound tracks with the proper directionality and intensity.

IMPORTANT NOTE: Listeners are often confused about the operation of the surround channels. While some assume that sound should always be coming from each speaker, most of the time there will be little or no sound in the surround channels. This is because they are only used when a movie director or sound mixer specifically places sound there to create ambience, a special effect or to continue action from the front of the room to the rear. When the output levels are properly set, it is normal for surround speakers to operate only occasionally. Artificially

increasing the volume to the rear speakers may destroy the illusion of an enveloping sound field that duplicates the way you hear sound in a movie theater or concert hall.

Before beginning the output level adjustment process, make certain that all speaker connections have been properly made. The system volume should be set to the level that you will use during a typical listening session, or to the recommended -15dB setting.

Using EzSet

Harman Kardon's exclusive EzSet remote makes it possible to quickly and accurately set the DPR 1001's output levels without the use of a sound-pressure meter, although manual adjustment is also available. However, for the easiest setup, follow these steps while seated in the listening position that will be used most often:

1. Make certain that all speaker positions have been properly configured for their "large" or "small" settings (as outlined above) and turn off the OSD system if it is in use.
2. Adjust the volume so that it is at -1.5dB , as shown in the on-screen display or **Lower Display Line B**.
3. Press and hold the **SPL Select Button 44** on the remote until the red LED under the **Set Button 16** lights and the LCD screen in the remote changes to the display shown in Figure 8.
4. Press the **Set Button 16** within five seconds to move to the next step.
5. Press the **▲ Navigation Button 14** until the lower line of the remote's LCD display shows the number of speakers in your system. (Don't count the subwoofer or speakers that are part of a multizone system!) For example, if you have left, center, right, surround left and right, and surround back left and right speakers for a full 7.1 system, press the button twice so that the bottom line reads **7 CHANNELS**, as shown in Figure 9.



```
SET SPKR LEVELS
EZSET
```

Figure 8

6. Hold the remote in front of you at arm's length, being sure not to cover the **EzSet Microphone Sensor 45** at the top of the remote, and press the **Set Button 16** within five seconds to begin the EzSet calibration process. At this point, EzSet will take control of your DPR, starting the test tone at the front left speaker, and automatically adjusting the output level so that this is correct. During the adjustment the on-screen display and the **Lower Display Line B** will display the speaker position on the left side of the display and the offset from reference level on the right side of the

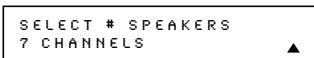

```
SELECT # SPEAKERS
7 CHANNELS
```

Figure 9

display. In addition, the speaker position will also appear on the left side of the remote's bottom line and the right side of the display will give you a level indication, as shown in Figure 10.



```
EZSET CHANNELS: 5
SPEAKER: 1 68dB
```

Figure 10

- The channel position being adjusted will flash in the **Speaker/Channel Input Indicators E**. If the test noise is heard from a channel other than the one shown in the Indicator, there is an error in the speaker connections. If this is the case, press the **Test Button 6** TWICE to stop the adjustment. Then, turn the unit off and verify that all speakers are connected to the proper **Speaker Outputs 22/23/24/25** and that any connections made to speakers powered by optional amplifiers through the **Preamp Outputs 28** are correct.
 - During the adjustment process for each channel, you will see indications of **LOW**, **HIGH** and a level readout in **dB**. This is normal, and it confirms that EzSet is doing its job of changing the levels to match the desired reference.
 - If a channel cannot be adjusted to the proper reference level, you will see **FAIL** displayed in the remote's bottom LCD line before the test tone moves to the next channel. This is usually an indication that the volume control was set too low. When EzSet stops circulating the tone through all channels and returns to normal, adjust the volume level and repeat the procedure from Step 3.
7. After the test noise has circulated once through each channel, it will send the tone to each channel once again, to verify the settings.
 8. After two complete circulations of the tone, the levels are set. Upon completion of the second circulation, the **LCD Information Display 3** will flash **COMPLETE** three times and then go out. The tone will stop and the DPR 1001 will return to normal operation.

If you find that the output levels chosen by EzSet are either uncomfortably low or high, you may repeat the procedure. Return to Step 2 and adjust the master volume either slightly higher or lower to accommodate your particular room layout and your tastes. You may repeat this procedure as many times as necessary to achieve a desired result. In order to prevent possible damage to your hearing or your equipment, we emphasize that you should avoid setting the master volume above 0dB .

Manual Output Level Adjustment

Output levels may also be adjusted manually, either to set them to a specific level with an SPL meter, or to make fine tuning adjustments to the levels obtained using the EzSet remote.

Manual output level adjustment is most easily done through the **CHANNEL ADJUST** menu. If you are already at the **MAIN** menu, press the **Navigation Button 14** until the **CHANNEL ADJUST** line is highlighted. If you are not at the **MAIN** menu, press the **OSD Button 31** to bring up the **MAIN** menu (Figure 1), and then press the **Navigation Button 14** until the **CHANNEL ADJUST** line is highlighted in reverse video. Press the **Set Button 16** to bring the **CHANNEL ADJUST** menu (Figure 11) to the screen.

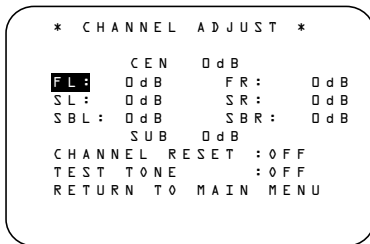

Figure 11

When the menu appears, press the **Navigation Buttons 14** until **TEST TONE** is highlighted in reverse video. Press the **Navigation Button 14** so that **ON** appears; a test noise will begin to circulate in a clockwise direction around the room. The test noise will play for two seconds in each speaker before circulating, and the name of each speaker location will be highlighted in reverse video when it is active.

NOTE: Remember to verify that the speakers have been properly connected. As the test noise circulates, listen to make certain that the sound comes from the speaker position shown. If the sound from a speaker location does NOT match the position indicated in the display, turn the DPR 1001 off using the **Main Power Switch 19** and check the speaker wiring or connections to external power amplifiers to make certain that each speaker is connected to the correct output terminal.

After checking for speaker placement, let the test noise circulate again, and listen to see which channels sound louder than the others. Using the front left speaker as a reference, press the **Navigation Buttons 14** on the remote to bring all speakers to the same volume level. When one of the **Navigation Buttons 14** is pushed, the test noise circulation will pause on the channel being adjusted to give you time to make the adjustment. When you release the button, the circulation will resume after five seconds.

Continue to adjust the individual channels until the volume level sounds the same from each speaker. Adjustments should be made with the **Navigation Buttons 14** on the remote only, NOT the main volume controls. If you are using a sound-pressure level (SPL) meter for precise level adjustment, set the volume so that the meter reads 72dB, C-Weighting Slow.

The DPR's EzSet feature may also be used as an SPL meter to assist in accurate setting of the output levels, when either the internal test tone or an external source such as a test disc is used. To use the remote as an SPL meter, follow these steps:

1. Press and hold the **SPL Select Button 44** on the remote until the red LED under the **Set Button 16** lights and the LCD screen in the remote changes to the display shown in Figure 8.
2. Press the **Navigation Button 14** once to change the bottom line of the remote's LCD display to read **MANUAL SPL** as shown in Figure 12.

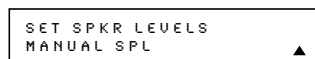

Figure 12

3. Press the **Set Button 16** within five seconds to activate the remote's manual mode, so that it functions as an SPL meter. The right corner of the bottom line of the remote's display will show the output level of the speakers as the test tone circulates. The level will show as a direct SPL indication between **66dB** and **79dB**. Below **66dB** the remote will read **LOW** and above **79dB** it will read **HIGH**.
4. When you are finished with all adjustments, press the **Clear Button 10** to return the remote to normal operation.

NOTE: The subwoofer output level is not adjustable using the test tone. To change the subwoofer level, follow the steps for Output Level Trim Adjustment on page 29.

When all channels have an equal volume level, the adjustment is complete. To exit this menu, press the **Navigation Buttons 14** until the on-screen **▶** cursor is next to the **BACK TO MAIN MENU** line, and then press the **Set Button 16** to return to the **MAIN** menu.

The output levels may also be adjusted at any time using the remote control and semi-OSD system. To adjust the output levels in this fashion, press the **Test Button 6**. As soon as the button is pressed, the test tone will begin to circulate as indicated earlier. The correct channel from which the test noise should be heard will be shown in the lower third of the video screen and in the **Main Information Display 16**. While the test noise is circulating, the **Speaker/Channel Input Indicator E** for the proper channel position will blink.

To adjust the output level, press the **Navigation Buttons 14** until the desired level is shown in the display or on screen. Once the buttons are released, the test noise will begin to circulate again in five seconds.

When all channels have the same output level, press the **Test Button 6** again to complete the process.

NOTE: Output level adjustment is not available for the VMAx or Surround Off mode.

Additional Input Adjustments

After one input has been adjusted for Surround mode, digital input (if any), speaker type and output levels, go back to the **IN/OUT SETUP** line in the **MAIN** menu and enter the settings for each input that you will use. In most cases, only the digital input and surround mode will be different from one input to the next, while the speaker type, crossover frequency, Night mode and output level settings will usually be the same and may be quickly entered by entering the same data used for the original input.

Once the settings outlined on the previous pages have been made, the DPR 1001 is ready for operation. While there are some additional settings to be made, these are best done after you have had an opportunity to listen to a variety of sources and different kinds of program material. These advanced settings are described on pages 30 and 31 of this manual. In addition, any of the settings made in the initial configuration of the unit may be changed at any time. As you add new or different sources or speakers, or if you wish to change a setting to better reflect your listening taste, simply follow the instructions for changing the settings for that parameter as shown in this section.

Having completed the setup and configuration process for your DPR 1001, you are about to experience the finest in music and home theater listening. Enjoy!

OPERATION

Basic Operation

Once you have completed the initial setup and configuration of the DPR 1001, it is simple to operate and enjoy. The following instructions will help you maximize the enjoyment of your new receiver:

Turning the DPR 1001 On or Off

- When using the DPR 1001 for the first time, you must press the **Main Power Switch 19** located behind the **Drop-Down Door 18** on the front panel to turn the unit on. This places the unit in a Standby mode, as indicated by the red color of the **Power Indicator 1**. Once the unit is in Standby, you may begin a listening session by pressing the **Standby/On Button 2** on the front panel or the **AVR Selector 5**. The **Power Indicator 1** will turn green. This will turn the unit on and return it to the input source that was last used. The unit may also be turned on from Standby by pressing any of the **Input Selector** buttons on the remote **4 34 43 B C D**.

NOTE: After pressing one of the **Input Selector Buttons 4 34 43** to turn the unit on, press the **AVR Selector 5** to set the remote control to the DPR 1001 functions.

To turn the unit off at the end of a listening session, simply press the **Standby/On Button 2** on the front panel or the **Power Off Button 1 A** on the remote. Power will be shut off to any equipment plugged into the rear panel **Switched AC Outlet 26** and the **Power Indicator 1** will turn red.

When the remote is used to turn the unit "off" it is actually placing the system in a Standby mode, as indicated by the red color of the **Power Indicator 1**.

- To program the DPR 1001 for automatic turn-off, press the **Sleep Button 29** on the remote. Each press of the button will decrease the time before shut-down in the following sequence:

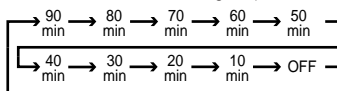

The sleep time will be displayed in the **Lower Display Line B** and it will count down until the time has elapsed.

When the programmed sleep time has elapsed, the unit will automatically turn off. The front panel display will dim to one-half brightness when the Sleep function is programmed. To cancel the Sleep function, press and hold the **Sleep Button 29** until the information display returns to normal brightness, the Sleep indicator numbers disappear and the words **SLEEP OFF** appear in the **Lower Display Line B**.

When you will be away from home for an extended period of time it is always a good idea to completely turn the unit off with the front panel **Main Power Switch 19**.

NOTE: All preset memories are lost if the unit is left turned off by using the **Main Power Switch 19** for more than two weeks.

Remote Control Operation

The DPR 1001's advanced remote includes a two-line LCD display that makes it easy to operate both the DPR and any other product that the remote has been programmed for. Complete information on programming the remote for operation with other devices and configuring its options are found on pages 32–41.

The following items provide some additional details on using the remote with the DPR 1001:

- The name of the command code transmitted when a button is pressed printed on the button key or just to the top of the button on the remote itself. In addition, when a button is pressed, the function being transmitted will also appear in the bottom line of the remote's LCD display.
- In order to send a command to the DPR, the **AVR Selector 5** must be pressed. To send a command to another device, first press the **Input Selector 4** for that device.
- The remote will automatically return to the controls for the DPR within five seconds after the button for another device is pressed.
- The factory default setting for the remote is to have the **Volume Up/Down 18** and **Mute 33** buttons operate the DPR, regardless of which device (such as the DVD or another video source) is in use.
- The factory setting for the remote is to have the **Transport Forward/Reverse Play Buttons 17**, **Transport Fast Play/Scan Forward/Reverse Buttons 19**, **Main Transport Controls 20** and **Track Skip Up/Down Buttons 21** operate the DVD player, regardless of which device (including the DPR) is in use. This simplifies operation, as in normal use you will use the DPR controls, and this means that you do not have to press the DVD button to control a player.

You may change the "punch-through" setting which allows the buttons for Volume, Transport Control or Channel Up/Down to be assigned into another device by following the instructions on page 37.

- The remote has a built-in backlight that may be activated by pressing the **Light Button 26**. This button is made from a special "glow" material so that it is easier to find in dark rooms. This glow feature does not use any electricity, but the glow will fade when the remote is kept in a dark location for an extended period of time. Restore the "glow" feature by placing the remote in normal room light for a few hours.
- The remote's backlight will remain lit for approximately five seconds after the **Light Button 26** is pressed, and it will stay lit for another five seconds

if any key is pressed while the backlight is on. You may keep the backlight lit by holding the Light button, but note that extensive use of the backlight will reduce battery life.

- The LCD display will remain on for 10 seconds after a key is pressed and then turn off to conserve battery life.
- When any button is held for more than 30 seconds the LCD will turn off and the remote will stop transmitting the codes to conserve battery life.
- Some of the buttons on the remote do not have a function on certain devices. For example, the Channel Up/Down buttons do not operate in the normal DPR mode unless they have been assigned for this purpose using the "punch-through" process as explained on page 37. This is normal and does not indicate any problem with the remote. When it is normal for a button not to have a function, you will see the device name in the top left side of the remote's LCD display, but you will not see the transmit icon on the upper right side of the display or any button function name on the bottom line of the display.

Source Selection

- To select a source, press any of the **Source Selector Buttons** on the remote **4 34 43 C D**.
- The input source may also be changed by pressing the front panel **Input Source Selector 6**. Each press of the button will move the input selection through the list of available inputs.
- As the input is changed, the DPR 1001 will automatically switch to the digital input (if selected), surround mode, speaker configuration, output levels, crossover frequency and night mode status that were entered during the configuration process for that source.
- The front panel **Video 4 Inputs 24** may be used to connect a device such as a video game or camcorder to your home entertainment system on a temporary basis.
- As the input source is changed, the new input name will appear momentarily as an on-screen display in the lower third of the video display. The input name will also appear in the **Upper Display Line F** and a green LED will light next to the selected input's name in the front panel **Input Indicators 17**.
- When an audio source is selected, the last video input used remains routed to the **Video Outputs 12 16** and **Video Monitor Output 35**. This permits simultaneous viewing and listening to different sources.
- When a Video source is selected, the video signal for that input will be routed to the **Video Monitor Output Jack 35** and will be viewable on a TV monitor connected to the DPR 1001.

Volume Control

- Adjust the volume to a comfortable level using the front panel **Volume Control 14** or remote **Volume Up/Down 18** **1** buttons.
 - To temporarily silence all speaker outputs, press the **Mute Button 33** **K**. This will interrupt the output to all speakers and the headphone jack, but it will not affect any recording or dubbing that may be in progress. When the system is muted, the word **MUTE** will flash in the on-screen display and the **Upper Display Line F**. Press the **Mute Button 33** **K** again to return to normal operation.
 - The DPR 1001 may be set so that the tone controls are either activated or "flat", which de-activates them. To change the tone mode setting, press the **Tone Control Button 32** and the current tone control status will be displayed in the on-screen display and **Lower Display Line B**. **TONE OUT** indicates that the controls are not in the circuit path, while **TONE IN** tells you that they are active. To switch modes, press the **▲/▼ Navigation Buttons 14** within five seconds of pressing the **Tone Control Button 32**. Each button press will switch the mode.
 - To change the actual tone mode settings, press the **Tone Control Button 32**. If **TONE OUT** appears, press the **▲/▼ Navigation Buttons 14** to activate the tone controls. With **TONE IN** in the displays, press the **Tone Control Button 32** again within five seconds and **TREBLE MODE** will appear in the displays. Press the **▲/▼ Navigation Buttons 14** until the desired amount of treble boost appears. To adjust the bass boost, press the **Tone Control Button 32** so that **BASS MODE** appears and once again press the **▲/▼ Navigation Buttons 14** to enter the desired amount of bass boost. When all adjustments are complete, wait five seconds and the tone control settings will time out and the unit will return to normal operation.
- NOTE:** Both the Treble and Bass controls are boosts, which means that you will see only positive numerical indications when making tone control adjustments.
- For private listening, plug the 1/4" stereo phone plug from a pair of stereo headphones into the front panel **Headphone Jack 20**. When the headphone's plug is connected, the word **HEADPHONE** will scroll once across the **Main Information Display 16** and all speakers will be silenced. When the headphone plug is removed, the audio feed to the speakers will be restored.

Surround Mode Selection

One of the most important features of the DPR 1001 is its ability to reproduce a full multichannel surround sound field from digital sources, analog matrix surround-encoded programs and standard stereo programs.

Selection of a surround mode is based on personal taste, as well as the type of program source material being used. For example, motion pictures or TV programs bearing the logo of one of the major surround-encoding processes, such as Dolby Surround or DTS Stereo, may be played in the Dolby Digital, Surround EX™, Dolby Pro Logic II – Movie, DTS Neo:6 or Logic 7 surround modes, depending on the source material.

NOTE: Once a program has been encoded with matrix surround information, it retains the surround information as long as the program is broadcast in stereo. Thus, movies with surround sound may be decoded via any of the analog surround modes such as Dolby Pro Logic II – Movie, Logic 7 Cinema or DTS Neo:6 Cinema, when they are broadcast via conventional TV stations, cable, pay-TV and satellite transmission. In addition, a growing number of programs are produced with Dolby Surround encoding. You may view a list of these programs at the Dolby Laboratories Web site at www.dolby.com.

Even when a program is not listed as carrying intentional surround information, you may find that the Dolby Pro Logic II, Logic 7 Enhance (available only in the 5.1 configuration), DTS Neo:6, VMAx, Hall or Theater modes may deliver enveloping surround presentations through the use of the natural information present in all stereo recordings. However, for stereo, but not surround programs, we suggest that you experiment with the other modes.

Surround modes may be selected using either the front panel controls or the remote. To select a surround mode from the front panel, first press the **Surround Mode Selector 3**. This will cycle through the available surround mode groupings.

Once the desired surround mode group name appears, press the **Surround Select Button 4** to cycle through the choices that are available within that mode group. The choices will vary based on the speaker configuration and input source. Some modes may be used only when seven speaker channels are available (e.g., Dolby Digital EX, Logic 7/7.1 and DTS-ES 6.1), while others (Dolby Digital, Logic 7/5.1 and DTS) are only available when five speaker channels are configured.

To select a surround mode using the remote control, first determine which overall surround group the mode is in. The groupings are the same as when changing modes using the front panel controls. For example, to select Dolby Pro Logic II – Music you will need to press the **Dolby Surround Mode Select Button 42** or to select VMAx you will use the **DSP Surround Mode Selector 7**. Using the button that matches the sur-

round group, press the **Dolby Surround Mode Select Button 42**, **DTS Digital Mode Select Button 41**, **Logic 7 Mode Select Button 8**, **DTS Neo:6 Mode Select Button 40**, **DSP Surround Mode Selector 7** or **Stereo Mode Select Button 39**. Depending on the current speaker configuration (5.1 or 6.1/7.1), each subsequent press of the button will display the modes available in that grouping. When the desired mode name appears in the on-screen display and **Lower Display Line B**, simply wait five seconds for the setting to be entered into memory. When the on-screen display times out, the unit has returned to normal operation, and the mode name will remain in the **Lower Display Line B**.

As the surround modes change, an amber LED will light next to the current mode in the **Surround Mode Indicators 18** list on the front panel.

The Dolby Digital and DTS 5.1, DTS-ES Matrix and DTS-ES Discrete modes may only be selected when a digital input is in use. In addition, when a digital source is present, the DPR 1001 will automatically select and switch to the correct mode, regardless of the mode that has been previously selected. For more information on selecting digital sources, see the following section.

To listen to a program in traditional two-channel stereo, using the front left and front right speakers only (plus the subwoofer, if installed and configured), press the **Stereo Mode Select Button 39** until **SURR OFF** appears in the **Lower Display Line B**.

Digital Audio Playback

Digital audio is a major advancement over analog surround processing systems such as Dolby Pro Logic. It delivers five discrete channels: left front, center, right front, left surround and right surround. Each channel reproduces full frequency range (20Hz to 20kHz) and offers dramatically improved dynamic range and signal-to-noise ratios. In addition, digital systems have the capability to deliver an additional channel that is specifically devoted to low-frequency information. This is the ".1" channel referred to when you see these systems described as "5.1", "6.1" or "7.1". The bass channel is separate from the other channels, but since it is intentionally bandwidth-limited, sound designers have given it that unique designation.

Dolby Digital

Dolby Digital is a standard part of DVD, and is available on specially encoded LD discs and satellite broadcasts and it is a part of the high-definition television (HDTV) system.

Dolby Digital bitstreams may be encoded in a variety of channel configurations, ranging from traditional two-channel stereo to the latest Dolby Digital Surround EX technology.

Once the DPR 1001's processor recognizes the Dolby Digital bitstream, a variety of surround modes may be applied, as indicated in the previous section.

(Continued on p. 27)

OPERATION

Surround Mode Chart

MODE	FEATURES
Dolby Digital	Available only with digital input sources encoded with Dolby Digital data. It provides up to five separate main audio channels and a special dedicated Low-Frequency Effects channel.
Dolby Digital EX	Available when the DPR 1001 is configured for 6.1/7.1-channel operation, Dolby Digital EX is the latest version of Dolby Digital. When used with movies or other programs that have special encoding, Dolby Digital EX reproduces specially encoded soundtracks so that a full 6.1/7.1 sound field is available. When the DPR is set for 6.1/7.1 operation and a Dolby Digital signal is present, the EX mode is automatically selected. Even if specific EX encoding is not available to provide the additional channel, the special algorithms will derive a 6.1/7.1 output.
DTS 5.1	When the speaker configuration is set for 5.1-channel operation, the DTS 5.1 mode is available when DVD, audio-only music or laser discs encoded with DTS data are played. DTS 5.1 provides up to five separate main audio channels and a special dedicated low-frequency channel.
DTS-ES 6.1 Matrix DTS-ES 6.1 Discrete	When the speaker configuration is set for 6.1/7.1 operation, playback of a DTS-encoded program source will automatically trigger the selection of one of the two DTS-ES modes. Newer discs with special DTS-ES discrete encoding will be decoded to provide six discrete, full-bandwidth channels plus a separate low-frequency channel. All other DTS discs will be decoded using the DTS-ES Matrix mode, which creates a 6.1-channel sound field from the original 5.1-channel soundtrack.
Dolby Pro Logic II Movie Music Pro Logic	Dolby Pro Logic II is the latest version of Dolby Laboratory's benchmark surround technology that decodes full-range, discrete left, center right, right surround and left surround channels from either matrix surround encoded programs and conventional stereo sources when an analog input is in use. The Dolby Pro Logic II Movie mode is optimized for movie soundtracks, while the Pro Logic II Music mode should be used with musical selections. The Pro Logic mode re-creates original Pro Logic processing for those who prefer that presentation.
Logic 7 Cinema Logic 7 Music Logic 7 Enhance	Exclusive to Harman Kardon for A/V receivers, Logic 7 is an advanced mode that extracts the maximum surround information from either surround-encoded programs or conventional stereo material. Depending on the number of speakers in use and the selection made in the SURROUND SELECT and LOGIC 7 menus, the "5.1" versions of Logic 7 modes are available when the 5.1 option is chosen, while the "7.1" versions of Logic 7 produce a full sound field presentation, including back surround speakers when the "6.1/7.1" option is chosen. The Logic 7 C (or Cinema) mode should be used with any source that contains Dolby Surround or similar matrix encoding. Logic 7 C delivers increased center-channel intelligibility, and more accurate placement of sounds with fades and pans that are much smoother and more realistic than with other decoding techniques. The Logic 7 M or Music mode should be used with analog or PCM stereo sources. Logic 7 M enhances the listening experience by presenting a wider front soundstage and greater rear ambience. Both Logic 7 modes also direct low-frequency information to the subwoofer (if installed and configured) to deliver maximum bass impact. The Logic 7 E (or Enhance) mode, available only when the 5.1 option is chosen, is an extension of the Logic 7 modes that is primarily used with musical programs. Logic 7 adds additional bass enhancement that circulates low frequencies in the 40Hz to 120Hz range to the front and surround speakers to deliver a less localized soundstage that appears broader and wider than when the subwoofer is the sole source of bass energy.
DTS Neo:6 Cinema DTS Neo:6 Music	These two modes are available when any analog source is playing to create a six-channel surround presentation from conventional Matrix-encoded and traditional Stereo sources. Select the Cinema version of Neo:6 when a program with any type of analog Matrix surround encoding is present. Select the Music version of Neo:6 for optimal processing when a nonencoded, two-channel stereo program is being played.
Dolby 3 Stereo	Uses the information contained in a surround-encoded or two-channel stereo program to create center-channel information. In addition, the information that is normally sent to the rear-channel surround speakers is carefully mixed in with the front-left and front-right channels for increased realism. Use this mode when you have a center-channel speaker but no surround speakers.
Theater	The Theater mode creates a sound field that resembles the acoustic feeling of a standard live performance theater.
Hall 1, Hall 2	The two Hall modes create sound fields that resemble a small (Hall 1) or medium-sized (Hall 2) concert hall.
VMAx Near VMAx Far	When only the two front-channel loudspeakers are used, Harman's patented VMAx mode delivers a three-dimensional sound space with the illusion of "phantom speakers" at the center and surround positions. The VMAx N, or "Near Field" mode should be selected when your listening position is less than five feet from the speakers. The VMAx F, or "Far Field" mode should be selected when your listening position is greater than five feet from the speakers. The VMAx modes are also available using the Headphones Output 20 . When headphones are being used, the Far Field mode will appear to push the sound field away from your ears, reducing the "inside the head" sensation often experienced when using headphones.
5-Channel Stereo 7-Channel Stereo	These modes take advantage of multiple speakers to place a stereo signal at both the front and back of a room. Depending on whether the DPR has been configured for either 5.1 or 6.1/7.1 operation, one of these modes, but not both, is available at any time. Ideal for playing music in situations such as a party, it places the same sound at the front-left and surround-left, and front-right and surround-right speakers. The center channel is fed a summed mono mix of the in-phase material of the left and right channels.
Surround Off (Stereo)	This mode turns off all surround processing and presents the pure left- and right-channel presentation of two-channel stereo programs.

(Continued from p. 25)

An optional, external RF demodulator is required to use the DPR 1001 to listen to the Dolby Digital soundtracks available on laser discs. Connect the RF output of the LD player to the demodulator and then connect the digital output of the demodulator to the **Optical or Coaxial Inputs** **30** **31** **21** **23** of the DPR 1001. No demodulator is required for use with DVD players or DTS-encoded laser discs.

DTS

The DTS digital audio system also delivers 5.1 or 6.1 discrete or matrix sound field reproduction. Both DTS and Dolby Digital are digital, but they use different methods of encoding the signals, and thus they require different decoding circuits to convert the digital signals back to analog.

DTS-encoded soundtracks are available on select DVD and LD discs, as well as on special audio-only DTS discs and video games. You may use any DVD, LD or CD player equipped with a digital output to play DTS-encoded discs with the DPR 1001. All that is required is to connect the player's output to either the **Optical or Coaxial Input** on the rear panel **30** **31** or front panel **21** **23**.

In order to listen to DVDs encoded with DTS soundtracks, the DVD player must be compatible with the DTS signal as indicated by a DTS logo on the player's front panel. Early DVD players may not be able to play DTS-encoded DVDs. This does not indicate a problem with the DPR 1001, as some players cannot pass the DTS signal through to the digital outputs. If you are in doubt as to the capability of your DVD player to handle DTS discs, consult the player's owner's manual.

PCM

PCM, which is the acronym for Pulse Code Modulation, is the type of digital bitstream used by standard CD audio discs. When a CD or DVD player is connected to the DPR 1001 and a CD is playing, the **PCM Bitstream Indicator** **A** will light. You will also see this indication if you are playing an LD disc with the standard digital soundtrack.

MP3

MP3 is the popularly used description for the digital audio format that is technically known as "MPEG-1/ Layer 3" audio. When a properly formatted MP3 signal from a compatible computer or sound card, or from an external digital format translator, is connected to the DPR 1001, the **MP3 Bitstream Indicator** **A** will light.

Selecting a Digital Source

To utilize a digital mode, you must have properly connected a digital source to the DPR 1001. Connect the digital outputs from DVD players, HDTV receivers, satellite systems or CD players to the **Optical or Coaxial Inputs** **30** **31** **21** **23**, and configure the input source for use with a digital input as shown on page 18.

In order to provide a backup signal and a source for analog recording, the analog outputs on digital source equipment should also be connected to their appropriate inputs on the DPR 1001 rear panel (e.g., connect the analog stereo audio output from a DVD to the **DVD Audio Inputs** **20** on the rear panel).

When a digital source is playing, the DPR 1001 will automatically detect whether it is a multichannel Dolby Digital, DTS or MP3 source, or a conventional PCM signal, which is the standard output from CD players. A **Bitstream Indicator** **A** will light to confirm that the digital signal is Dolby Digital, DTS, PCM or MP3.

Digital Status Indicators

When a digital source is playing, the DPR 1001 senses the type of bitstream data that is present. Using this information, the correct surround mode will automatically be selected. For example, DTS bitstreams will cause the unit to switch to DTS decoding, and Dolby Digital bitstreams will enable Dolby Digital decoding. When the unit senses PCM data from CDs or LDs, it will allow the appropriate surround sources to be selected manually. Since the range of available surround modes is dependent on the type of digital data that is present, the DPR 1001 uses a variety of indicators to let you know what type of signal is present. This will help you to understand the choice of modes.

When a digital source is playing, a **Bitstream Indicator** **A** will light to show which type of signal is playing:

DOLBY D: When the DOLBY D indicator lights, a Dolby Digital bitstream is being received. Depending on the settings on the source player and specific surround information and number of channels on the disc, a number of surround modes are possible. For discs with full 5.1 audio, only the Dolby Digital and VMaX modes are available.

DTS: When the DTS indicator lights, a DTS bitstream is being received. When the unit senses this type of data, only the applicable DTS mode may be used.

PCM: When the PCM indicator lights, a standard Pulse Code Modulation signal is being received. This type of digital audio is used by compact disc and laser disc recordings. When a PCM bitstream is present, all modes except Dolby Digital and DTS are available.

MP3: When the MP3 indicator lights, a compatible MPEG 1/Layer 3 digital signal is being received. This is the popular audio format used by many computer programs for recording compressed audio files. When an MP3 bitstream is present, the sound will automatically be played in the Stereo (Surround Off) mode. The surround modes are not available during MP3 playback.

Night Mode

A special feature of Dolby Digital is the Night mode, which enables specially encoded Dolby Digital input sources to be played back with full digital intelligibility while reducing the peak level by $1/4$ to $1/3$. This

prevents abruptly loud transitions from disturbing others, without reducing the impact of the digital source. The Night mode is available only when Dolby Digital signals with special data are being played.

The Night mode may be engaged when a Dolby Digital DVD is playing by pressing the **Night Mode Button** **30** on the remote. Next, press the **▲/▼ Navigation Buttons** **14** to select either the middle range or full compression versions of the Night mode. To turn the Night mode off, press the **▲/▼ Navigation Buttons** **14** until the message in the lower third of the video display and the **Main Information Display** **16** reads **D - RANGE OFF**.

The Night mode may also be selected to always be on at either level of compression using the options in the **DOLBY SURR** menu. See page 19 for information on using the menus to set this option.

IMPORTANT NOTES ON DIGITAL PLAYBACK:

- While almost all DVD discs contain a Dolby Digital soundtrack, the type of soundtrack (e.g., a full 5.1 presentation or only a stereo 2.0 soundtrack) available may differ from disc to disc. While many discs instruct the player to default to the 5.1 output when available, many players do not. Also, while many discs now contain DTS soundtracks, in addition to the Dolby Digital presentation, your player may *not* automatically output the DTS signal. Please check the default settings in your DVD player so that it defaults to the 5.1 output or DTS, when available, depending on your listening preferences. Although the DPR 1001 is capable of decoding Dolby Digital 5.1, Surround EX, DTS and DTS-ES data streams, you may not be able to access them unless your DVD player is properly configured. Consult the owner's manual for your DVD player for more information on the proper menu settings and disc-play commands so that the player sends the correct digital information to the DPR 1001.
- When the digital playback source is stopped, or in a pause, fast forward or chapter search mode, the digital audio data will momentarily stop. This is normal and does not indicate a problem with either the DPR 1001 or the source machine. The DPR 1001 will return to digital playback as soon as the data is available and when the machine is in a standard play mode.
- Although the DPR 1001 will decode virtually all DVD movies, CDs and HDTV sources, it is possible that some future digital sources may not be compatible with the DPR 1001.
- Note that not all digitally encoded programs contain full 5.1-channel audio. Consult the program guide that accompanies the DVD or laser disc to determine which type of audio has been recorded on the disc. The DPR 1001 will automatically sense the type of digital surround encoding used and adjust to accommodate it.

OPERATION

- When a digital source is playing, you may not be able to select some of the analog surround modes such as Dolby Pro Logic II, Dolby 3, Stereo, Hall, Theater or Logic 7.
- When a Dolby Digital or DTS source is playing, it is not possible to make an analog recording using the Tape **7** and Video 1 or Video 2 Audio Outputs **13 17**. However, the digital signals will be passed through to the Digital Audio Outputs **21**.

PCM Audio Playback

PCM (Pulse Code Modulation) is the noncompressed digital audio system used for compact discs and laser discs. The digital circuits in the DPR 1001 are capable of high-quality digital-to-analog decoding, and they may be connected directly to the digital audio output of your CD or LD player.

Connections may be made to either the rear panel Optical or Coaxial Inputs **30 31** or the front panel Digital Inputs **21 23**.

When a PCM source is playing, the PCM Indicator **A** will light. During PCM playback, you may select any Surround mode except Dolby Digital or DTS.

MP3 Audio Playback

The DPR 1001 is among the few A/V receivers to provide onboard decoding for the MP3 audio format used by computers and portable audio devices. By offering MP3 decoding, the DPR 1001 is able to deliver precise conversion of the digital signals to an analog output, along with the benefits of listening to the MP3 audio through the DPR 1001's high-current amplifier and the speakers from your surround system, rather than the smaller speakers and low-powered amplifiers typically used with computers.

To take advantage of the DPR 1001's MP3 capabilities, simply connect the PCM output of a computer's sound card or the PCM output of a portable digital audio device to either the rear-panel Digital Inputs **30 31** or the front panel Digital Inputs **21 23**. When the digital signal is available, the MP3 Bitstream Indicator **A** will light, and the audio will begin playing.

NOTES:

- The DPR 1001 is only capable of playing signals in the MP3 (MPEG 1/Layer 3) format. It is not compatible with other computer audio codecs.
- The digital audio input signal may be either optical or coaxial, but the signal must be in the S/P-DIF format. Direct connection of USB or serial data outputs is not possible, even though the signals are in the MP3 format. If you have any questions about the data output format from your computer or a sound card, check with the device's owner's manual or contact the manufacturer's technical support area.

- If your computer or sound card's digital output is not capable of direct connection to the DPR, you may use an optional, external transcoder to convert the USB output of a computer to a format compatible with the DPR.

Tuner Operation

The DPR 1001's tuner is capable of tuning AM, FM and FM Stereo broadcast stations. Stations may be tuned manually, or they may be stored as favorite station presets and recalled from a 30-position memory.

Station Selection

1. Press the AM/FM Tuner Select Button **34 C** on the remote to select the tuner as an input. The tuner may be selected from the front panel by either pressing the Input Source Selector **6** until the tuner is active or by pressing the AM/FM Selector **5** at any time.
2. Press the AM/FM Tuner Select Button **34 C** or AM/FM Selector **5** again to switch between AM and FM so that the desired frequency band is selected.
3. Press the Tuning Mode Selector **7 12** to select manual or automatic tuning.
4. To select stations, press the Tuning Selector **8 23 E**. When the Auto Tuning mode is in use, press and release the button and the tuner will search for the next highest- or lowest-frequency station that has an acceptable signal. When tuning FM stations in the Auto mode, the tuner will only select stereo stations. To tune to the next station, press the button again.
5. When the Tuning Mode Selector **7 12** is pressed so that Manual Tuning is selected, each press of the Tuning Selector **8 23 E** will change the frequency one increment up or down. As the frequency is changed in the manual mode, the Lower Display Line **B** and the on-screen display will indicate **TUNED MONO** when a station with acceptable signal strength for listening is selected.
6. Stations may also be tuned directly by pressing the Direct Button **9**, and then pressing the Numeric Keys **11** that correspond to the station's frequency. The desired station will automatically be tuned. If you press an incorrect button while entering a direct frequency, press the Clear Button **10** to start over.

NOTE: When the FM reception of a station is weak, audio quality will be increased by switching to Mono mode by pressing the Tuning Mode Button **7 12** until the on-screen display and the Lower Display Line **B** read **MANUAL TUNING**.

Preset Tuning

Using the remote, up to 30 stations may be stored in the DPR 1001's memory for easy recall using the front panel controls or the remote.

To enter a station into the memory, first tune the station using the steps outlined above. Then:

1. Press the Memory Button **38** on the remote. **PRESET MEMORY** will flash in the Lower Display Line **B**.
2. Within five seconds, press the Numeric Keys **11** corresponding to the location where you wish to store this station's frequency. Once entered, the preset number will appear to the right of the station's frequency in the Upper Display Line **F**.
3. Repeat the process after tuning any additional stations to be preset.

Recalling Preset Stations

- To manually select a station previously entered in the preset memory, press the Numeric Keys **11** that correspond to the desired station's memory location.
- To manually tune through the list of stored preset stations one by one, press the Preset Stations Selector Buttons **9 22 G** on the front panel or remote.

Recording

In normal operation, the audio or video source selected for listening through the DPR 1001 is sent to the record outputs. This means that any program you are watching or listening to may be recorded simply by placing machines connected to the Tape Outputs **7** or Video 1 or 2 Outputs **12 13 16 17** in the record mode.

When a digital audio recorder is connected to the Digital Audio Outputs **21**, you are able to record the digital signal using a CD-R, MiniDisc or other digital recording system.

NOTES:

- The digital outputs are active only when a digital signal is present, and they do not convert an analog input to a digital signal, or change the format of the digital signal. In addition, the digital recorder must be compatible with the output signal. For example, the PCM digital input from a CD player may be recorded on a CD-R or MiniDisc, but Dolby Digital or DTS signals may not.
- Please make certain that you are aware of possible copyright restrictions on any material you copy. Unauthorized duplication of copyrighted materials is prohibited by federal law.

Front Panel Connections

In addition to rear-panel outputs, the DPR 1001 offers Harman Kardon's exclusive configurable front panel output jack feature. You may switch the front panel **Digital Coax Jack 23** or the **Video 4 Jacks 24** from an input to an output by following these steps:

1. Press the **OSD Button 31** to view the **MAIN** menu (Figure 1).
2. Press the **Set Button 16** to enter the **IN/OUT SETUP** menu (Figure 2).
3. Press the **▼ Navigation Button 14** so that **VIDEO 4** or **COAXIAL 3** is highlighted in reverse video, depending on which input you wish to change to an output. Either input or both may be changed at any time.
4. Press the **Set Button 16** and then press either of the **◀/▶ Navigation Buttons 14** so that the word **OUT** appears.
5. Press the **Set Button 16** to enter the change.
6. Press the **OSD Button 31** to exit the menus and return to normal operation.

Once the setting is made, the appropriate **Input/Output Status Indicator 22** will turn red, indicating that the selected analog or digital jacks are now an output, instead of in the default setting as an input. Once changed to an output, the setting will remain as long as the DPR 1001 is turned on, unless the setting is changed in the OSD menu system, as described above. However once the DPR 1001 is turned off, the setting is cancelled. When the unit is turned on again, the front panel jacks will return to their normal default setting as an input. If you wish to use these jacks as an output at a future time, the setting must be changed again using the OSD menu system, as described above.

Output Level Trim Adjustment

Normal output level adjustment for the DPR 1001 is established using the test tone, as outlined on pages 22 and 23. In some cases, however, it may be desirable to adjust the output levels using program material such as a test disc, or a selection you are familiar with. Additionally, the output level for the subwoofer can only be adjusted using this procedure.

When adjusting channel output levels, the EzSet remote may be used to serve as an SPL meter so that levels may be set more accurately. To use the remote in its manual mode for this purpose, follow the instructions shown on page 23.

To adjust the output levels using program material, first set the reference volume for the front left and front right channels using the **Volume Control 14 18 1**.

To adjust the channel output levels using an external source from the remote, press the **Channel Select Button 13**; the on-screen display and the **Lower Display Line B** will read **FRONT L LEVEL**, indicating that the Front Left channel is ready for adjustment. To trim the level, press the **Set Button 16** and then use the **▲/▼ Navigation Buttons 14** to make the adjustment. When the correct level has been reached, press the **Set Button 16** to enter the setting and then press the **▲/▼ Navigation Buttons 14** to select the next channel to be adjusted. Repeat the procedure for any channels that need adjustment, remembering that the goal is to have all channels deliver sound at the same level.

To adjust the channel output levels using an external source from the front panel, first press the **Set Button 11**. Within five seconds press the **▲/▼ Navigation Buttons 10/12** until **CHANNEL MODE** appears in the on-screen display and the **Lower Display Line B**; an amber LED will also light next to **CHANNEL** in the **System Configuration Indicators 15**. Within five seconds press the **Set Button 11** again and the on-screen display and the **Lower Display Line B** will change to **FRONT L LEVEL**, indicating that the Front Left channel is ready for adjustment. To trim the level, press the **Set Button 11** and then use **▲/▼ Navigation Buttons 10/12** to make the adjustment. When the correct level has been reached, press the **Set Button 11** to enter the setting and then press the **▲/▼ Navigation Buttons 10/12** to select the next channel to be adjusted. Repeat the procedure for any channels that need adjustment, remembering that the goal is to have all channels deliver sound at the same level.

The channel output for any input may also be adjusted using the full-OSD on-screen menu system. Press the **OSD Button 31** to bring up the **MAIN** menu (Figure 1). Press the **▼ Navigation Button 14** until the **CHANNEL ADJUST** line is highlighted in reverse video. Press the **Set Button 16** to activate the **CHANNEL ADJUST** menu (Figure 11).

Once the menu appears on your video screen, use the **▲/▼ Navigation Buttons 14** to select the channels to be adjusted. At each channel position use the **◀/▶ Navigation Buttons 14** to change the output level. Remember, the goal is to have the output level at each channel sound equal when heard at the listening position.

If you wish to reset all the levels to their original factory default of 0dB offset, press the **▲/▼ Navigation Buttons 14** so that the **CHANNEL RESET** line is highlighted in reverse video and press the **◀/▶ Navigation Buttons 14** so that the word **ON** appears. After the levels are reset, resume the procedure outlined above to adjust the levels to the desired settings. When all adjustments are done, press the **▲/▼ Navigation Buttons 14** until **RETURN TO MAIN MENU** is highlighted in reverse video and then press the **Set Button 16** if you wish to go back to the main menu to make other adjustments. If you have no other adjustments to make, press the **OSD Button 31** to exit the menu system.

NOTE: The output levels may be separately trimmed for each digital and analog surround mode. If you wish to have different trim levels for a specific mode, select that mode and then repeat the instructions in this section.

6-Channel/8-Channel Direct Input

The DPR 1001 is equipped for future expansion through the use of optional, external adapters for formats that the DPR 1001 may not be capable of processing or to allow connection to the output of high-resolution optical audio playback systems such as DVD-Audio or SACD. When a device with six-channel outputs (5.1 audio) is used, connect the source device to the **6-Channel Direct Inputs 33**. When a device with eight-channel outputs (7.1) audio is used, connect the additional Surround Back Left (SBL) and Surround Back Right (SBR) outputs to the **8-Channel Direct Inputs 34** on the DPR 1001. To select these inputs, press the **6-Channel/8-Channel Input Select Button 43** on the remote.

When the 6-Channel or 8-Channel Direct Input is in use, you may not select a surround mode, as the external decoder determines the processing in use. In addition, there is no signal at the record outputs when the 6-Channel or 8-Channel Direct Input is in use.

Memory Backup

This product is equipped with a memory backup system that preserves the system configuration information and tuner presets if the unit is accidentally unplugged or subjected to a power outage. This memory will last for approximately two weeks, after which time all information must be reentered.

ADVANCED FEATURES

The DPR 1001 is equipped with a number of advanced features that add extra flexibility to the unit's operation. While it is not necessary to use these features to operate the unit, they provide additional options that you may wish to use.

Surround Back Amplifier Assignment

The DPR 1001 has a total of seven amplifier channels so that you may enjoy the latest 7.1 surround programs without the need for additional, external amplifiers. In most cases the DPR 1001 will be used for 7.1 operation, so the factory default is to have the surround back channels configured for surround outputs. To use the DPR for full 7.1 operation, or when the multiroom system is not in use, there is no need to change the factory default setting on the first line of the **ADVANCED** menu. Skip to one of the sections below to make any needed adjustments.

However, in some situations, you may wish to use the surround back channel amplifiers to power the speakers in a remote zone so that you can still enjoy 5.1 surround playback for the main listening room while a second room receives the separate output selected by the DPR's multiroom system. You may configure the system for that type of operation using the **SB AMPS** line of the Advanced menu by following the instructions in the Multiroom Operation section of this manual on page 31.

Display Brightness

The DPR 1001's **Main Information Display 16** is set at a default brightness level that is sufficient for viewing in a normally lit room. However, in some home-theater installations, you may wish to occasionally lower the brightness of the display, or turn it off completely.

To change the display brightness setting for a specific listening session, you will need to make an adjustment in the **ADVANCED** menu. To start the adjustment, press the **OSD Button 31** to bring the **MAIN** menu to the screen. Press the **▼ Navigation Button 14** until the **ADVANCED** line is highlighted in reverse video. Press the **Set Button 16** to enter the **ADVANCED** menu (Figure 13).

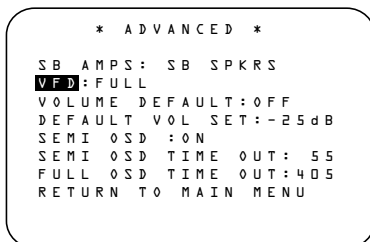

Figure 13

To change the brightness setting, at the **ADVANCED** menu, make certain that the **VFD**

line is highlighted in reverse video, and press the **► Navigation Button 14** until the desired brightness level is highlighted in the video display. When **FULL** is highlighted, the display is at its normal brightness. When **HALF** is highlighted, the display is at half the normal brightness level. When **OFF** is highlighted, all of the indicators in the **Main Information Display 16** will go dark. Note, however, that the amber LEDs for the **Input Indicators 17**, **Surround Mode Indicators 18** and the **System Configuration Indicators 15**, as well as for the **Power Indicator 1**, will always remain lit to remind you that the unit is turned on.

Once the desired brightness level is selected, it will remain in effect until it is changed again or until the unit is turned off.

If you wish to make other adjustments, press the **▲/▼ Navigation Buttons 14** until the desired setting is highlighted in reverse video, or highlight the **RETURN TO MAIN MENU** line and then press the **Set Button 16** to select another menu for adjustment. If no further adjustments are required, press the **OSD Button 31** to exit the menu system.

Turn-On Volume Level

As is the case with most audio/video receivers, when the DPR 1001 is turned on, it will always return to the volume setting in effect when the unit was turned off. However, you may prefer to always have the DPR 1001 turn on at a specific setting, regardless of what was last in use when the unit was turned off. To change the default condition so that the same volume level is always used at turn-on, you will need to make an adjustment in the **ADVANCED** menu. To start the adjustment, press the **OSD Button 31** to bring the **MAIN** menu (Figure 1) to the screen. Press the **▼ Navigation Button 14**, until the **ADVANCED** line is highlighted in reverse video. Press the **Set Button 16** to enter the **ADVANCED** menu (Figure 13).

At the **ADVANCED** menu make certain that the **VOLUME DEFAULT** line is highlighted in reverse video by pressing the **▲/▼ Navigation Button 14** as needed. Next, press the **► Navigation Button 14** so that the word **ON** is appears in the video display. Next, press the **Navigation Button 14** once so that the on-screen **►** cursor is next to the **DEFAULT VOL SET** line. To set the desired turn-on volume, press the **◀/► Navigation Button 14** until the desired volume level is shown on the **DEFAULT VOL SET** line. This setting may NOT be made with the regular volume controls.

NOTE: Since the setting for the turn-on volume cannot be heard while the setting is being made, you may

wish to determine the setting before making the adjustment. To do this, listen to any source and adjust the volume to the desired level using the regular **Volume Controls 14 18 1**. When the desired volume level to be used at turn-on is reached, make a note of the setting as it appears in the lower third of the video screen or in the **Lower Display Line B**. (A typical volume level will appear as a negative number such as -25dB .) When making the adjustment, use the **◀/► Navigation Button 14** to enter this setting.

Unlike some of the other adjustments in this menu, the turn-on volume default will remain in effect until it is changed or turned off in this menu, even when the unit is turned off.

If you wish to make other adjustments, press the **▲/▼ Navigation Buttons 14** until the desired setting is highlighted in reverse video, or highlight the **RETURN TO MAIN MENU** line and then press the **Set Button 16** to select another menu for adjustment. If no further adjustments are required, press the **OSD Button 31** to exit the menu system.

Semi-OSD Settings

The semi-OSD system places one-line messages at the lower third of the video display screen whenever the Volume, Input Source, Surround mode or tuner frequency of any of the configuration settings are changed. The semi-OSD system is helpful in that it enables you to have feedback on any control changes or remote commands using the video display when it is difficult to view the front panel displays. However, you may occasionally prefer to turn these displays off for a particular listening session. You may also want to adjust the length of time the displays remain on the screen. Both of those options are possible with the DPR 1001.

To turn off the semi-OSD system, you will need to make an adjustment in the **ADVANCED** menu (Figure 13). To start the adjustment, press the **OSD Button 31** to bring the **MAIN** menu to the screen. Press the **▼ Navigation Button 14**, until the **ADVANCED** line is highlighted in reverse video. Press the **Set Button 16** to enter the **ADVANCED** menu.

At the **ADVANCED** menu, make certain that the **SEMI OSD** line is highlighted in reverse video by pressing the **▲/▼ Navigation Buttons 14** as needed. Next, press the **► Navigation Button 14** so that the word **OFF** appears.

This setting is temporary and will remain active only until it is changed or until the DPR 1001 is turned off. Once the unit is turned off, the semi-OSD displays will remain activated, even if they were switched off for the previous listening session.

To change the length of time that the semi-OSD displays remain on the screen, go to the **ADVANCED** menu as outlined earlier, and press the **▲/▼ Navigation Buttons 14** as needed, until the **SEMI OSD TIME OUT** line is highlighted in reverse video. Next, press the **◀/▶ Navigation Buttons 14** until the desired time in seconds is displayed. Unlike most of the other options in this menu, this is a permanent setting change, and the time-out entry will remain in effect until it is changed, even when the unit is turned off.

If you wish to make other adjustments, press the **▲/▼ Navigation Buttons 14** until the desired setting is highlighted in reverse video, or highlight the **RETURN TO MAIN MENU** line and then press the **Set Button 16** to select another menu for adjustment. If no further adjustments are required, press the **OSD Button 31** to exit the menu system.

Full-OSD Time-Out Adjustment

The **FULL OSD** menu system is used to simplify the setup and adjustment of the DPR 1001, using a series of on-screen menus. The factory default setting for these menus leaves them on the screen for 20 seconds after a period of inactivity before they disappear from the screen (Time-Out). Time-Out is a safety measure to prevent image retention of the menu text in your monitor or projector, which might happen if it were left on indefinitely. However, some viewers may prefer a slightly longer or shorter period before the Time Out display.

To change the Full-OSD Time-Out, you will need to make an adjustment in the **ADVANCED** menu (Figure 13). To start the adjustment, press the **OSD Button 31** to bring the **MAIN** menu to the screen. Press the **▼ Navigation Button 14**, until the **ADVANCED** line is highlighted in reverse video. Press the **Set Button 16** to enter the **ADVANCED** menu (Figure 13).

At the **ADVANCED** menu (Figure 13) make certain that the **FULL OSD TIME OUT** line is highlighted in reverse video by pressing the **▲/▼ Navigation Buttons 14** as needed. Next, press the **◀/▶ Navigation Buttons 14** until the desired time is displayed in seconds. Unlike most of the other options in this menu, this is a permanent setting change, and the Time-Out entry will remain in effect until it is changed, even if the unit is turned off.

If you wish to make other adjustments, press the **▲/▼ Navigation Buttons 14** until the desired setting is highlighted in reverse video, or highlight the **RETURN TO MAIN MENU** line and then press the **Set Button 16** to select another menu for

adjustment. If no further adjustments are required, press the **OSD Button 31** to exit the menu system.

Multiroom Operation

The DPR 1001 is fully equipped to operate as the control center for a multiroom system with optional remote external infrared (IR) sensors, speakers and power amplifiers. Although some multiroom installations will require the services of a specially trained installer, it is possible for the average do-it-yourself hobbyist to install a simple remote room system.

Installation

The key to remote room operation is to link the remote room to the DPR 1001's location with wire for an infrared link and speakers or an amplifier. For installation instructions for Multiroom use, see page 15.

Multiroom Setup

Once the audio and IR link connections have been made, the DPR 1001 needs to be configured for multiroom operation using the steps below. Press the **OSD Button 31** to bring the **MAIN** menu (Figure 1) to the screen. Press the **▼ Navigation Button 14** until the **MULTI-ROOM** line is highlighted. Press the **Set Button 16** to enter the **MULTI-ROOM** menu (Figure 14).

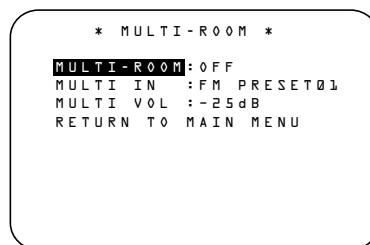

Figure 14

When the **MULTI-ROOM** menu appears, the **MULTI-ROOM** line will be highlighted. Since this line is used to turn the system on and off, do not make an adjustment here unless you wish to turn the system on at this time. To turn the system on, press the **▶ Navigation Button 14** so that **ON** appears. If you do not wish to turn the system on at this time or to proceed to the next step, press the **▼ Navigation Button 14** so that the **MULTI IN** line is highlighted.

At the **MULTI IN** line, press the **◀/▶ Navigation Buttons 14** until the desired input to the multiroom system appears. When the selection has been made, press the **▼ Navigation Button 14** once so that the **MULTI VOL** line is highlighted.

At the **MULTI VOL** line, press the **◀/▶ Navigation Buttons 14** until the desired volume level for the multiroom system is entered. DO NOT use the regular volume control knobs for this setting. When all

settings for the multiroom setup have been made, press the **▲/▼ Navigation Buttons 14** until the **RETURN TO MAIN MENU** line is highlighted. If you have no other adjustments to make, press the **OSD Button 31** to exit the menu system.

Multiroom Amplifier Configuration

Since the DPR 1001 is equipped with seven channels of amplification, they may be allocated to either full 7.1 channel operation, or they may alternatively be used to power speakers that are fed the output of the multiroom system. Thus, when only 5.1 channels are required for the main listening room, you may power speakers in a second zone without the need for additional external amplifiers. This is a major improvement over the use of simple "Speaker A/B" switches, as it allows for a fully separate source and independent volume levels at the remote location.

To configure the DPR so that the amplifiers normally used for the Surround Back channels are used for the multiroom system, you must make an adjustment in the **ADVANCED** menu (Figure 13). To start the adjustment, press the **OSD Button 31** to bring the **MAIN** menu to the screen. Next, press the **▼ Navigation Button 14** until the **ADVANCED** line is highlighted in reverse video. Press the **Set Button 16** to enter the **ADVANCED** menu.

When the **ADVANCED** menu is on the screen, the **SB AMPS** item at the top of the menu list will be highlighted in reverse video. Press the **◀/▶ Navigation Buttons 14** so that the right side of the menu line changes to **MULTI ROOM**.

When this configuration adjustment is complete, press the **▲/▼ Navigation Buttons 14** until **RETURN TO MAIN MENU** is highlighted in reverse video and press the **Set Button 16** to select another menu for adjustment. If no further adjustments are required, press the **OSD Button 31** to exit the menu system.

IMPORTANT NOTE: Once the amplifiers are configured as shown above so that the multiroom outputs are powered by the DPR's internal amplifier, the speaker configuration will automatically be reset for 5.1 channel operation in the main room. This means that 6.1/7.1-channel operation will not be possible until the setting shown above is returned to OFF. For that reason, use of the internal amplifier for multiroom operation is recommended only if your main listening room uses a 5.1 speaker system. If the main room has a 6.1 or 7.1 speaker setup, it will be necessary to use an optional, external power amplifier to power the speakers used in the multiroom system.

CONFIGURING THE REMOTE

Multiroom Operation

When operating the DPR 1001 from a remote room location where an IR sensor link has been connected to the DPR 1001's rear-panel **Multiroom IR Input 3**, you may use either the main remote control or the Zone II remote. To turn on the multiroom feed, press any of the **Input Selector** buttons on the Zone II remote **C D** or the main remote **4 34 43**. Press the **AVR Selector 5 B** to turn the unit on to the last source, or any of the other **Selector** buttons to turn on to a specific source.

As long as an IR feed to the DPR 1001 has been established from the remote room, using any of the buttons on either remote will control the remote location volume **18 1**, change the tuner frequency **23 E**, change the tuner preset **22 G** or mute the output **33 K**.

If the DPR 1001's **Remote IR Output Jack 4** is connected to an IR Input jack on compatible Harman Kardon audio components such as CD, DVD or cassette players, the transport functions of those machines may also be controlled using the **Transport Controls 17 19 20 21 24 E F G H J** on either remote control.

To turn the system off from the remote room, press the **Power Off Button 1 A**. Remember that the DPR 1001 may be turned on or off from the remote room, regardless of the system's operation or status in the main room.

NOTE: When the tuner is selected as the source for the remote zone, any change to the frequency or preset will also change the station being listened to in the main room, if the tuner is in use there. Similarly, if someone in the main room changes the station, the change will also impact the remote room.

To activate the feed to the remote room, while you are in the main listening room where the DPR 1001 is located, press the **Multiroom Button 27** on the remote. Next, press the **Set Button 16**. Press the **▲/▼ Navigation Buttons 14** to turn the multiroom feed on or off. When the multiroom system is on, the **Multi Indicator C** will light in the **Main Information Display 16**, and the **Lower Display Line B** and OSD will display **MULTI ON**. Press the **Set Button 16** to enter the setting.

When the multiroom system is turned on, the input selected using the multiroom menu will be fed to the **Multiroom Output Jacks 9** on the rear panel. The volume will be as set in the previous selection, although it may also be adjusted using an optional IR sensor and the Zone II remote in the remote location or on the optional audio power amplifier connected to the **Multiroom Output Jacks 9**.

Once the multiroom system is turned on, it will remain on even if the DPR 1001 is placed in the Standby mode in the main room by pressing the **Power Off Button A 1** or the **On/Standby Button 2**. To turn off the multiroom system, even when the DPR is in Standby

mode in the main listening room, press the **Multiroom Button 27** and then the **Set Button 16**. Press the **▲/▼ Navigation Buttons 14** so that the **Multiroom Indicator C** goes out, and the **Lower Display Line B** and OSD will display **MULTI OFF**. Press the **Set Button 16** to enter the setting and turn the unit off.

Even when the DPR 1001 is turned off in the main room, the multiroom system may be turned on at any time by pressing the **Multiroom Button 27**, or any of the **Selector Buttons B C D** in the remote room.

Configuring the Remote

The DPR 1001 remote is factory-programmed for all functions needed to operate the unit. In addition, it is also preprogrammed to operate most recent Harman Kardon DVD players and changers, CD players and changers, CD recorders and cassette decks. The codes for other brand devices may be programmed into the DPR 1001 remote using its extensive library of remote codes or a head-to-head learning process for codes not in the internal library.

Thanks to the remote's advanced technology and two-line LCD display, it is no longer necessary to look up cumbersome codes when programming the remote; following the steps outlined below, you simply search for the brand name from the remote's memory. We recommend that you first try the preprogrammed code entry method. If that procedure is not successful, then try the code learning method.

Preprogrammed Code Entry

The easiest way to program the DPR remote for operation with a source device from another brand is to follow these steps:

1. Turn on the power to the device you wish to program into the DPR remote. This is important, as in a later step you will need to see whether the device turns off to determine whether the remote has been programmed for the proper remote codes.
2. Press and hold the **Program Button 25** for about three seconds while the message shown in Figure 15 appears in the remote's **LCD Information Display 3**. Release the button when the red light under the **Set Button 16** appears.

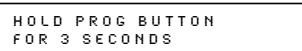

HOLD PROG BUTTON
FOR 3 SECONDS

Figure 15

3. The remote's **MAIN MENU** message (Figure 16), will appear in the LCD display and the **Set Button 16** will remain illuminated in red. Press the **Set Button 16** to begin the process of selecting a device and locating the proper remote codes.

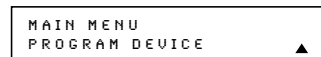

MAIN MENU
PROGRAM DEVICE

Figure 16

4. **SELECT A DEVICE** will appear in the LCD display (Figure 17). Press the **▲/▼ Navigation Buttons 14** to scroll through the list of device categories and press the **Set Button 16** when the device you wish to set the codes for appears. For this example, we will select "TV" to enter the codes needed to operate your TV.



SELECT A DEVICE
TV

Figure 17

NOTE: The codes for hard-drive recorder products (PVR) such as TiVo and Replay are programmed by selecting VCR as the device. For satellite-based TiVo products, check under the brand name of the product.

5. At the next menu screen on the remote (Figure 18) press the **Set Button 16** to enter the Manual mode, which means that you will select the brand name of the device from the list programmed into the remote's memory.

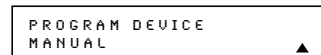

PROGRAM DEVICE
MANUAL

Figure 18

6. The next menu screen on the remote (Figure 19) will show the start of the list of available brands. Press the **▲/▼ Navigation Buttons 14** until the brand name of the device you are programming into the remote appears on the lower line of the display and then press the **Set Button 16**.



SELECT BRAND
RCA

Figure 19

NOTE: If the brand name for the product you wish to program does not appear in the list, the codes may still be available, as some manufacturers share codes. If the desired brand is not listed, press the **Clear Button 10** to exit the programming process, and skip to the instructions shown on page 33 for the "Automatic" method of programming the remote. If desired, or if the codes for your brand are not part of the remote's library at all, you may still use the DPR remote to program most infrared-controlled products by "learning" the commands from the product's original remote into the DPR remote. The instructions for Learning Commands are on page 34.

7. The next step is important, as it determines which codes will operate the source device or display. Point the DPR remote at the device being programmed and, following the instructions shown in the remote's **LCD Information Display 3**, press and release the **Numeric Keys 11** shown

on the menu screen (Figure 20) one at a time, starting with the "1" button. After you press the "1" Button 11, the remote's LCD screen will briefly go blank as the code is being transmitted, but you will see the "transmit" icon in the upper right corner of the display to serve as confirmation that the remote is sending out commands.

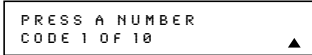

Figure 20

- After you press and release the number key, watch the device being programmed to see whether it turns off. As shown in the instructions that will appear on the next menu screen (Figure 21), if your device has turned off, press the Set Button 16, and then skip to Step 10. If the unit does *not* turn off, proceed to the next step.

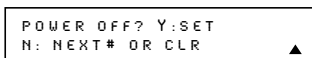

Figure 21

- If the device being programmed into the DPR remote does *not* turn off after you have pressed the "1" key, continue Steps 8 and 9 by pressing the available numeric keys shown until the device turns off. If the device still does not turn off after all choices have been tried, or if there is only one number key shown as available to try, the code for this specific device is not in the DPR remote library under that brand name. If that is the case, press the Clear Button 10 to exit the manual programming mode. Remember that the codes may still be stored in the DPR remote's library under another brand, and you can have the remote control search for them by following the instructions below for automatic programming. You may also manually "learn" the codes for most devices into the DPR remote by following the Learning Commands instructions on page 34.
- When the device being programmed does turn off after a numeric key has been pressed, you must press the Set Button 16 within five seconds to enter the setting into the remote's memory. After you press the Set button, the top line of the LCD display will read **SAVING...** and then the word **SAVED** will flash four times in the center of the bottom line.
- When the codes are saved the remote will return to normal operation, and whenever you press the Input Selector Button 4 that was just programmed, the codes for the new device will be used. If no further buttons are pressed, the remote will revert back to the default setting for AVR commands.

NOTE: Some brands share a common remote control code for "Power Off" for many models. For that reason it is possible that even though the remote appears to be properly programmed, you may find that some buttons do not appear to issue the correct command. If this is the case, repeat the procedure outlined above, but if more than one numeric key selection is suggested in Step 7, try a different number to see whether the remote operates correctly. Although the DPR remote is preprogrammed with an extensive library of codes for many major brands, it is also possible that you may have attempted to program a product that is too new or too old, and thus not all of its commands will be in the code library. You may fill in the codes for any button that does not operate properly by using the learning technique shown on page 34.

Automatic Code Entry

In addition to manual code selection using the brand name list, it is also possible to automatically search through all the codes that are stored in the DPR remote's library to see whether a device will respond even if it is not listed among the brands that appear when you program the remote manually. To automatically search through the codes that are available for a specific device type (e.g., DVD, VCR), follow these steps:

- Turn on the power to the device you wish to program into the DPR remote. This is important, as in a later step you will need to see whether the device turns off to determine whether the remote has been programmed for the proper remote codes.
- Press and hold the Program Button 25 for about three seconds while the message shown in Figure 15 appears in the remote's LCD Information Display 3. Release the button when the red light under the Set Button 16 appears.
- The remote's **MAIN MENU** message (Figure 16) will appear in the LCD display and the Set Button 16 will remain illuminated in red. Press the Set Button 16 to begin the process of selecting a device and locating the proper remote codes.
- SELECT A DEVICE** will appear in the LCD display (Figure 17). Press the ▲/▼ Navigation Buttons 14 to scroll through the list of device categories and press the Set Button 16 when the device for which you wish to set the codes appears. For this example, we will select "TV" to enter the codes needed to operate your TV.
- At the next menu screen on the remote (Figure 18), press the ▲ Navigation Button 14 so that the bottom line of the LCD display reads **AUTO**

(Figure 22) and then press the Set Button 16 to enter the Automatic programming mode.



Figure 22

- As instructed on the next menu screen, press the ▲ Navigation Button 14 to begin the automatic code search process. Your confirmation that the remote is sending out commands is the movement of a square block across the top line of the LCD display screen while the bottom line reads **PLEASE WAIT...** You will also see the transmit icon in the upper right corner of the LCD display's top line to remind you that the remote is working even though you may not see anything happening to the device being programmed.
- It will take a few seconds for the remote to send out the first group of commands, after which you will see a new display in the LCD screen, as shown in Figure 23. Following the instructions, if the device being programmed has *not* turned off, press the ▲ Navigation Button 14 again to send another group of codes. If the device being programmed *has* turned off, skip to Step 9.

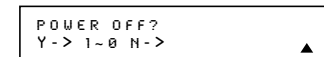

Figure 23

- By pressing the ▲ Navigation Buttons 14 again, the remote will send out a new set of commands. When it pauses, follow the instructions shown in Step 7. Depending on how many codes are stored for a specific device type, you may have to repeat this process as many as fifteen times. Remember, if the device turns off, skip to Step 9. When all the codes for the device being programmed have been tried, the instruction shown in Figure 24 will appear. This means that the codes for the product you are trying to program are not in the DPR remote library and you will have to "learn" them into the remote following the instructions shown on page 34. Press the Set Button 16 as instructed to exit the programming process.

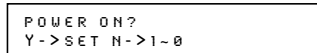

Figure 24

- If the device being programmed *does* turn off after following the instructions in Step 7, you will need to verify the code set by pressing the Numeric Keys 11 in sequence, as instructed in Figure 23. Point the remote at the device being programmed, and press the "1" Button 11 to see whether the device turns back on.

CONFIGURING THE REMOTE

10. After pressing and releasing the "1" Button 11, check to see whether the device has turned back on. If it has, skip to Step 12. If it does not turn off, press the "2" Button 11, or the next button in the numeric sequence if you are repeating the procedure, as instructed by the LCD screen in Figure 25.



```
POWER ON?  
Y->SET N->1-0
```

Figure 25

11. When pressing the "1" button does not turn the device being programmed back on, repeat the procedure by trying the remainder of the Numeric Keys 11 in sequence, each time pressing and then releasing the button to see whether the new device turns back on. When it does, skip to the next step. However, if you try all 10 numeric keys and find that the unit will not turn on, you won't be able to use this method to program the device. Press the Clear Button 10 to exit the programming process. You'll need to follow the Learning Commands instructions below to enter the codes for this device into the DPR remote.
12. When pressing one of the numeric keys in Step 10 or 11 causes the device being programmed to turn back on, follow the instructions shown in Figure 22 and press the Set Button 16 within five seconds of the device turning on. After you press the Set button, the top line of the LCD display will read **SAVING...** and then the word **SAVED** will flash four times in the center of the bottom line.
13. When the codes are saved, the remote will return to normal operation, and whenever you press the Input Selector Button 4 that was just programmed, the codes for the new device will be used. If no further buttons are pressed, the remote will revert back to the default setting for AVR commands.

Learning Commands

On occasions when the DPR remote does not contain the codes for a particular product's remote in its built-in library, or when you wish to program a missing or special function into one button of a device, the DPR remote's learning capability allows you to do that. To teach commands from one product's remote into the DPR remote, follow these steps:

The process requires that both the device's original remote and the DPR remote be available. Before pressing any buttons on either remote, place them so that the IR transmitter on the remote from the device to be programmed is facing the Infrared Lens 46 on the DPR's remote. The two remotes should be no more than an inch apart, and there should not be any

direct sunlight or other bright light source near the remotes.

1. Press and hold the Program Button 25 for about three seconds while the message shown in Figure 15 appears in the remote's LCD Information Display 3. Release the button when the red light under the Set Button 16 appears.

2. The remote's **MAIN MENU** message (Figure 16), will appear in the LCD display and the Set Button 16 will remain illuminated in red. Press the ▲ Navigation Button 14 once so that **LEARN** appears on the bottom line of the LCD screen, as shown in Figure 26. Press the Set Button 16 to begin the process of learning commands from another device's remote into the DPR remote.

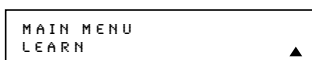

```
MAIN MENU  
LEARN
```

Figure 26

3. The **SELECT A DEVICE** message will appear in the LCD display (Figure 17). Press the ▲/▼ Navigation Buttons 14 to scroll through the list of device categories and press the Set Button 16 when the device for which you wish to set the codes appears. For this example, we will select "TV" to enter the codes needed to operate your TV.

4. The next menu screen (Figure 27) will prompt you to select the button, or "key," on the DPR remote that you wish to program. Press that button on the DPR remote.

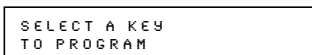

```
SELECT A KEY  
TO PROGRAM
```

Figure 27

5. Once you press the button to be programmed on the DPR remote, press and hold the button on the remote control for the device to be programmed within five seconds, as instructed on the next menu screen (Figure 28).



```
PRESS KEY ON  
ORIGINAL REMOTE
```

Figure 28

6. Continue to hold the button on the original remote until the menu on the DPR remote's LCD screen changes. If the code is successfully learned you will see the display shown in Figure 29. If you see that menu, proceed to Step 9. If the code is *not* successfully learned, you will see the display shown in Figure 30. If that menu appears, proceed to Step 8.



```
LEARN MENU  
LRN ANOTHER KEY
```

Figure 29



```
LEARN FAILED  
RETRY
```

Figure 30

7. If the message shown in Figure 26 appears in the display, press the Set Button 16 to try programming the button again. When the remote prompts you to press and hold the key on the original remote again by showing the display shown in Figure 28, immediately press the button on the source remote again. To avoid another failed attempt, make certain that the windows on the two remotes are facing one another.

8. Continue to hold the button on the original remote until the DPR's display changes again. If the code was successfully learned, you will see the display shown in Figure 29. In that case, skip to the next step. If the **LEARN FAILED** display (Figure 30) appears again you may either try to program the key again, or press the ▲ Navigation Buttons 14 to stop the process. It is possible that some remotes may use code sequences or infrared frequencies that are not compatible with the DPR remote, and those codes cannot be learned. When the display shown in Figure 31 appears, press the Set Button 16 to exit the Learning system.



```
LEARN FAILED  
EXIT
```

Figure 31

9. When a code has been learned successfully, you have three options. When the display shown in Figure 29 is on the LCD screen on the DPR remote, you may press the Set Button 16 to learn additional codes from the buttons on a remote into the DPR remote. Follow Steps 4 through 8 as often as needed to complete the code-learning process.
10. If you wish to change the name that appears in the LCD display when the button that has just had a new code learned is pressed, press the ▲ Navigation Button 14 so that the display shown in Figure 32 appears in the LCD display. At this point you will be taken to a **RENAME KEY** display. Enter the new name for the key following the instructions shown in the Renaming Individual Keys section of this manual on page 41. If you find it more convenient to rename the buttons at a later time, you may do that separately by following the instructions on page 39.

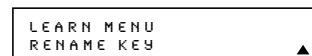

```
LEARN MENU  
RENAME KEY
```

Figure 32

11. When you have programmed all keys for the desired device, press the ▲ Navigation

Button **14** twice when the **LEARN MENU** (Figure 29) appears so that you see the display shown in Figure 33. The remote will return to normal operation within 30 seconds.



Figure 33

12. If you wish to program the codes for another device, repeat the procedure outline above, but select a different device in Step 3.

Changing Devices

In the factory default settings, the DPR remote is programmed so that the commands transmitted correspond to the device selected by pressing one of the **Input Selectors 4**. This is logical, as you want the remote to control the device you have selected. However, in some circumstances you may have configured your system so that the devices connected to the DPR do not correspond to the default device settings and the legends printed on the remote. For example, if your system has two VCRs you may connect the second VCR to the VID 2 input. There is no problem in doing that, but in normal operation the commands issued after selecting the VID 2 input are for a television, not a VCR.

The DPR remote allows you to correct that situation through the "Changing Devices" process. That enables you to assign the codes from one type of device to a different button. For example, in the steps below, we will explain how to program the VID 2 buttons to provide the commands to operate a VCR. Of course, you may program the remote to have any of the devices take on the code set of any other device, as your system requires. And, with the DPR remote's "Rename" function, you can even change the way the name of the device appears on the remote's LCD display so that you see exactly which commands are being sent.

To program the buttons normally assigned to one device for the commands of another, follow these steps:

1. Press and hold the **Program Button 25** for about three seconds while the message shown in Figure 15 appears in the remote's **LCD Information Display 3**. Release the button when the red light under the **Set Button 16** appears.
2. The remote's **MAIN MENU** message (Figure 16), will appear in the LCD display and the **Set Button 16** will remain illuminated in red. Press the **Navigation Button 14** twice so that **CHANGE DEVICE** appears on the bottom line of the LCD screen, as shown in Figure 34. Press the **Set Button 16** to begin the process

of reassigning the commands used for a particular device.

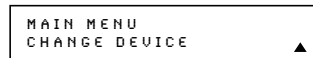

Figure 34

3. The next menu display is where you select the Input Select, or device, that you wish to change. When the display shown in Figure 35 appears, press the **Navigation Buttons 14** to scroll through the list to find the device you wish to use for another function. In this case we will select "TV," and show how to change it to take on the codes for operating a VCR. When that device's name appears, press the **Set Button 16**.



Figure 35

4. Once the "old" device type has been selected, you need to tell the remote which set of remote codes to use as a replacement for the device just selected. When the instructions shown in Figure 36 appear, press the **Navigation Buttons 14** to scroll through the list of device categories to find the name of the device that you wish to use. The old device name will remain on the left side of the LCD screen, while the replacement device list will scroll to its right. For example, press the **Navigation Button 14** until the display screen reads **TV<-VCR** to have the VID 2/TV Button transmit the commands used to control a VCR. Press the **Set Button 16** when the desired device combination appears.



Figure 36

5. Once the new device is selected, the remainder of the process will select the codes for the specific brand to be used, and for that reason they are identical to the way a device is programmed using manual entry. Continue the process as outlined in the next few steps, remembering that if the codes for your specific device are not found you may select any brand and then "learn" the proper codes into the DPR remote using the process outlined on page 34. To begin the process, start by selecting the brand of device, as shown in Figure 19. Press the **Navigation Buttons 14** until the brand name of the device you are programming into the remote appears on the lower line of the display and then press the **Set Button 16**.
6. The next step is important, as it determines which codes will operate the source device or display. Point the DPR remote at the device being pro-

grammed and, following the instructions shown on the remote's **LCD Information Display 3**, press and release the **Numeric Keys 11** one at a time, starting with the "1" button. After you press the **"1" Button 11** the remote's LCD screen will briefly go blank as the code is being transmitted, but you will see the "transmit" icon in the upper right corner of the display to serve as confirmation that the remote is sending out commands.

7. After you press and release the number key, watch the device being programmed to see whether it turns off. As shown in the instructions that will appear on the next menu screen (Figure 21), press the **Set Button 16**, and then skip to Step 9. If the unit does *not* turn off, proceed to the next step.
8. If the device being programmed into the DPR remote does *not* turn off after you have pressed the "1" key, continue Steps 6 and 7 by pressing the available numeric keys shown until the device turns off. If the device still does not turn off after all choices have been tried, the code for this specific device is not in the DPR remote library under that brand name. If that is the case, we suggest that you press the **Set Button 16** to accept the codes from another brand so that the programming is completed, but remember that you will then have to program the remote manually by following the Learning Commands instructions on page 34.
9. When the device being programmed does turn off after a numeric key has been pressed, you must press the **Set Button 16** within five seconds to enter the setting into the remote's memory. After you press the Set button, the top line of the LCD display will read **SAVING...** and then the word **SAVED** will flash four times in the center of the bottom line.
10. When the codes are saved the remote will return to normal operation, and whenever you press the **Input Selector Button 4** that was just programmed, the display will show the original device type code at the far left side of the display, with the name of the new code set type in brackets. For example, the display will read **TV[VCR]** in our example of replacing the TV codes with those for a VCR.

Macro Programming

Macros enable you to easily repeat frequently used combinations of multiple remote control commands with the touch of a single button. Once a macro is programmed you may send up to 20 commands with one press of the Power On or Macro buttons. This will greatly simplify the process of turning on

CONFIGURING THE REMOTE

your system, changing devices or other common tasks. Thanks to the remote's two-line display, it is easier than ever for you to take advantage of the power of macro commands.

Recording a Macro

To record a macro into the remote's memory, follow these steps:

1. Press and hold the **Program Button 25** for about three seconds while the message shown in Figure 15 appears in the **LCD Information Display 3**. Release the button when the red light under the **Set Button 16** appears.

2. The **MAIN MENU** message (Figure 16), will appear in the LCD display and the **Set Button 16** will remain illuminated in red. Press the **Navigation Button 14** three times so that **MACRO** appears on the bottom line of the LCD screen, as shown in Figure 37. Press the **Set Button 16** to enter the main macro menu.

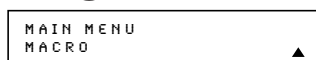

The LCD display shows "MAIN MENU" on the top line and "MACRO" on the bottom line. A small upward-pointing triangle is on the right side of the bottom line.

Figure 37

3. At the next menu screen (Figure 38) press the **Set Button 16** to begin recording a macro.



The LCD display shows "MACRO" on the top line and "RECORD A MACRO" on the bottom line. A small upward-pointing triangle is on the right side of the bottom line.

Figure 38

4. The next display screen (Figure 39) is where you select the button that will be used to recall the macro. The choices are the **Power On Button 2** or one of the discrete **Macro Buttons 28**. Press the **Navigation Buttons 14** until the name of the button you wish to program the macro into is shown and press the **Set Button 16**. For this example we will show how to program a series of commands that will be sent when the Power button is pressed.

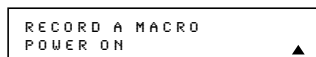

The LCD display shows "RECORD A MACRO" on the top line and "POWER ON" on the bottom line. A small upward-pointing triangle is on the right side of the bottom line.

Figure 39

5. The next screen that appears (Figure 40) is where you select the device for the first command that will be sent out as part of the macro. Press the **Navigation Buttons 14** until the name of the device appears in the lower line in the LCD display. For this example, the first button we want to have the macro "press" is the Power On button, so the AVR device is selected. Press the **Set Button 16** when the desired device name appears to move to the next programming step.



The LCD display shows "SELECT A DEVICE" on the top line and "AVR" on the bottom line. A small upward-pointing triangle is on the right side of the bottom line.

Figure 40

6. The next display (Figure 41) is where you begin entering the individual commands for the macro, in the order you wish them to be transmitted. Remember that when you want to change devices, you must first press the **Input Selector 4 5** for that button, and then press the **Command or Function key**. Since we want to program a series of events that occur each time the **Power On button** is pressed, press the AVR button. In your specific macro, this is the first command button.

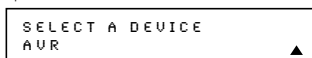

The LCD display shows "SELECT A DEVICE" on the top line and "AVR" on the bottom line. A small upward-pointing triangle is on the right side of the bottom line.

Figure 41

7. The next display (Figure 42) and the subsequent screens are where the actual macro programming take place. The words at the left side of the top line of the display show the button that is being programmed (e.g., the **Power On Button 2** or one of the **Macro Buttons 28**) and the indication at the right side of the top line shows the number of macro steps available of 20 possible steps. Following the instructions on the remote's LCD screen, press the first key you wish to be transmitted in the macro. In our example, we first want the DPR to turn on, so the **Power Button 2** should be pressed.

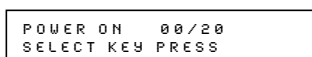

The LCD display shows "POWER ON 00/20" on the top line and "SELECT KEY PRESS" on the bottom line.

Figure 42

8. Once the first command button for the macro has been pressed, continue to press the buttons you wish to be part of the macro, in the order they will be used. Press each button within five seconds of the last button, remembering to press the **Input Selector 4 5** when you are changing device functions. As the buttons on the remote are pressed, the remote's display screen will show the steps in the macro as they are programmed (Figure 43).



The LCD display shows "[AVR]" on the top line and "[AVR] POWER ON" on the bottom line.

Figure 43

9. For our example, we first want the AVR Power On button pressed, followed by the TV Power On, followed by the Cable Box On, followed by the selection of the Logic 7 mode. To do that, press the buttons in this order:

- Power On 2
- VID 2/TV 4
- Power On 2

- VID 3/Cable 4
- Power On 2
- AVR 5
- Logic 7 8

As each button is pressed to enter it into the macro you will see the button names appear and then scroll up on the LCD display as your confirmation of the key entry (Figure 43).

10. When all commands for the macro have been entered, press the **Set Button 16** to save the macro. The display screen will show the button to which the macro has been programmed and the number of steps used, and the word **SAVED** will blink four times in the lower line of the LCD display. When the display returns to normal, the macro has been entered and the remote is ready for operation.

11. If a macro has been programmed into the **Power On Button 2**, it will play back anytime the Power On button is pressed. As the macro plays, you will see the steps appear in the remote's LCD display. Macros programmed into one of the four discrete Macro buttons may be activated at any time by pressing the appropriate button.

Erasing a Macro

Once a macro has been created and stored in the DPR remote's memory, you have the option of erasing it. You may do this at any time by following these steps:

1. Press and hold the **Program Button 25** for about three seconds while the message shown in Figure 15 appears in the remote's **LCD Information Display 3**. Release the button when the red light under the **Set Button 16** appears.
2. The remote's **MAIN MENU** message (Figure 16), will appear in the LCD display and the **Set Button 16** will remain illuminated in red. Press the **Navigation Button 14** three times so that **MACRO** appears on the bottom line of the LCD screen, as shown in Figure 37. Press the **Set Button 16** to enter the main macro menu branch.
3. At the next menu screen (Figure 44) press **Navigation Buttons 14** until the bottom line in the remote's LCD display reads **ERASE A MACRO**, as shown in Figure 44. Press the **Set Button 16** to begin the process of erasing a macro.



The LCD display shows "MACRO" on the top line and "ERASE A MACRO" on the bottom line. A small upward-pointing triangle is on the right side of the bottom line.

Figure 44

- The next display screen (Figure 45) is where you select which macro will be erased. Press the ▲/▼ **Navigation Buttons 14** until the number of the macro you wish to erase appears. For this example we will erase the Power On macro created in the previous section. When the name of the macro to be erased appears, press the **Set Button 16**.

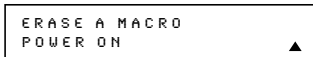

Figure 45

- The word **ERASED** will flash four times in the bottom line of the remote's LCD display, and then the display will return to its normal condition. When that happens the macro is erased and the remote is returned to normal operation.

Read a Macro

To check the commands stored in the remote's memory for one of the buttons, follow these steps:

- Press and hold the **Program Button 25** for about three seconds while the message shown in Figure 15 appears in the remote's **LCD Information Display 3**. Release the button when the red light under the **Set Button 16** appears.
- The remote's **MAIN MENU** message (Figure 16), will appear in the LCD display and the **Set Button 16** will remain illuminated in red. Press the ▲ **Navigation Button 14** three times so that **MACRO** appears on the bottom line of the LCD screen, as shown in Figure 37. Press the **Set Button 16** to enter the main macro menu branch.
- At the next menu screen (Figure 46) press the ▲/▼ **Navigation Buttons 14** until the bottom line in the remote's LCD display shows **READ A MACRO**, as shown in Figure 46. Press the **Set Button 16** to begin the process of erasing a macro.

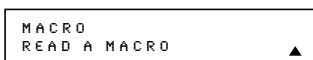

Figure 46

- The next display screen (Figure 47) is where you select the macro to be read. Press the ▲/▼ **Navigation Buttons 14** until the name of the macro you wish to read appears. For this example, we will read back the Power On macro created in the previous section. When the name of the macro to be erased appears, press the **Set Button 16**.

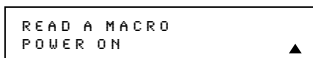

Figure 47

- As soon as the Set button is pressed, the first two steps in the macro will be appear in the remote's LCD screen. You may then use the ▲/▼ **Navigation Buttons 14** to step up or down through the list of commands stored as the macro. As you read the display, you will see **Device Selector Buttons 4 5** appear in brackets, (e.g., **[AUR]**). When the step in the macro is a function, navigation or any other button, it will appear next to the bracketed read-out of the underlying device (e.g., **[AUR] POWER ON**).
- When you are finished reviewing the macro's contents, press the **Set Button 16** to return the remote to normal operation.

Punch-Through Configuration

Punch-through is a capability of the remote that allows the Volume controls, Channel Up/Down buttons or Transport keys (Play, Stop, Record, Fast Forward and Reverse, and Skip Up/Down) to link to a different device. For example, if your TV, cable box or satellite receiver is connected through the DPR you will most likely want to use the DPR's volume control commands even when the remote has been set to issue all other commands for the video device. "Punch-through" enables you to easily program the remote to do this.

Volume Punch-Through

Follow these steps to enable the Volume Up/Down and Mute controls from one device to be used when the remote is otherwise programmed for a different device.

NOTE FOR VOLUME PUNCH-THROUGH: The remote's default settings are for the DPR's volume controls to be used when any input or device is selected with the exception of the VID 2/TV button. There is no need to program the remote for volume punch-through for the DPR's controls with other sources, such as DVD. To have the DPR's volume commands used when the TV device is selected, follow these steps:

- Press and hold the **Program Button 25** for about three seconds while the message shown in Figure 15 appears in the remote's **LCD Information Display 3**. Release the button when the red light under the **Set Button 16** appears.
- The remote's **MAIN MENU** message (Figure 16), will appear in the LCD display and the **Set Button 16** will remain illuminated in red. Press the ▲/▼ **Navigation Buttons 14** until **PUNCH-THROUGH** appears on the bottom line of the LCD screen, as shown in Figure 48. Press the **Set Button 16** to enter the main punch-through menu branch.



Figure 48

- At the next menu screen (Figure 49) press the **Set Button 16** to begin programming the remote for Volume punch-through.



Figure 49

- The next display screen (Figure 50) is where you select the device that will receive the punch-through commands. In our example, that is the VID 2/TV button, as that is where we want the DPR's volume controls to be active. Press the ▲/▼ **Navigation Buttons 14** until the name of the base device appears and then press the **Set Button 16**.

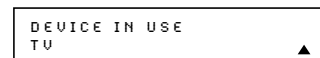

Figure 50

- At the next display screen (Figure 51), you will select the device whose Volume Up/Down and Mute commands will be used. Press the ▲/▼ **Navigation Buttons 14** until the desired device's name appears to the right of the device in use. In our example, that is the DPR (indicated by **AUR**). When the desired combination of devices appears, press the **Set Button 16**.

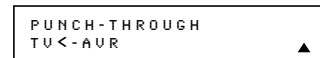

Figure 51

- When the Set button is pressed, the display will change to show you that the new combination of control commands is being saved to the unit's memory, as shown in Figure 52. The word **SAVED** will flash four times and then the remote will return to normal operation.

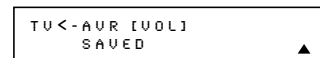

Figure 52

- Once the punch-through is programmed, the Volume Up/Down and Mute buttons of the second device named will be used when those buttons **18 33** are pressed while the master device is in use.

Returning the Volume Control Settings to Default Operation:

If you wish to remove the Volume punch-through so that the commands for Volume and Mute are returned to the factory default setting, follow the steps shown above, except that in Steps 4 and 5, select the same device for both the **DEVICE IN USE** on the left side

CONFIGURING THE REMOTE

of the bottom line and the **PUNCH-THROUGH** device. In the example used, the display to return the remote to default settings will appear as shown in Figure 53.

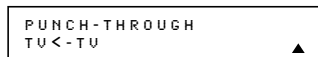

Figure 53

Channel Punch-Through

Channel punch-through allows the Channel Up/Down buttons to send commands to a different device than the one that has been selected for other commands. For example, you may wish to use a cable box or satellite receiver as the source for a VCR, so you would want the **Channel Up/Down Selectors** 35 to transmit commands to the cable box even though the other button commands are programmed to operate the VCR.

To program the DPR for Channel punch-through, follow these steps. This example will show how to program channel punch-through so that the commands programmed for Channel Up/Down for the VID 3/ Cable device will be transmitted when the VID 1/VCR device has been selected as the current device.

1. Press and hold the **Program Button** 25 for about three seconds while the message shown in Figure 15 appears in the remote's **LCD Information Display** 3. Release the button when the red light under the **Set Button** 16 appears.
2. The remote's **MAIN MENU** message (Figure 16), will appear in the LCD display and the **Set Button** 16 will remain illuminated in red. Press the **▲/▼ Navigation Buttons** 14 until **PUNCH-THROUGH** appears on the bottom line of the LCD screen, as shown in Figure 49. Press the **Set Button** 16 to enter the main punch-through menu branch.
3. At the next menu screen, press the **▲/▼ Navigation Buttons** 14 until **CHANNEL** appears on the bottom line of the LCD screen, as shown in Figure 54. Press the **Set Button** 16 to begin programming the remote for Channel punch-through.



Figure 54

4. The next display screen (Figure 55) is where you select the device that will receive the punch-through commands. In our example, that is the VID 2/TV button, as that is where we want the cable box's channel controls to be active. Press the **▲/▼ Navigation Buttons** 14 until the name of the base device appears and then press the **Set Button** 16.

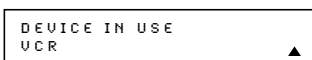

Figure 55

5. At the next display screen (Figure 56), you will select the device whose Channel Up/Down commands will be used. Press the **▲/▼ Navigation Buttons** 14 until the desired device name appears to the right of the device in use. In our example, that is the cable box. When the desired combination of devices appears, press the **Set Button** 16.



Figure 56

6. When the Set button is pressed, the display will change to show you that the new combination of control commands is being saved to the unit's memory, as shown in Figure 57. The word **SAVED** will flash four times and then the remote will return to normal operation.



Figure 57

7. Once the punch-through is programmed, the channel up/down buttons of the second device named will be used when those buttons 35 are pressed while the master device is in use.

Returning the Channel Control Settings to Default Operation:

If you wish to remove the Channel Punch-Through so that the commands for Channel Up/Down are returned to the factory default setting, follow the steps shown above, except that in Steps 4 and 5, select the same device for both the **DEVICE IN USE** on the left side of the bottom line and the **PUNCH-THROUGH** device. In the example used, the display to return the remote to default settings will appear as shown in Figure 58.

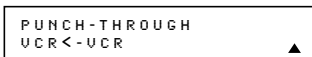

Figure 58

Transport Punch-Through

Transport punch-through allows the **Play** 17, **Stop** 20, **Fast Forward/Reverse** 19, **Pause** 20, **Record** 20 and **Skip Up/Down** 21 buttons to send commands to a different device than the one that has been selected for other commands. For example, you may wish to operate the transport of a second VCR you have connected to the VID 2/TV input, as shown in the following example.

1. Press and hold the **Program Button** 25 for about three seconds while the message shown

in Figure 15 appears in the remote's **LCD Information Display** 3. Release the button when the red light under the **Set Button** 16 appears.

2. The remote's **MAIN MENU** message (Figure 16), will appear in the LCD display and the **Set Button** 16 will remain illuminated in red. Press the **▲/▼ Navigation Buttons** 14 until **PUNCH-THROUGH** appears on the bottom line of the LCD screen, as shown in Figure 48. Press the **Set Button** 16 to enter the main punch-through menu branch.
3. At the next menu screen, press the **▲/▼ Navigation Buttons** 14 until **TRANSPORT** appears on the bottom line of the LCD screen, as shown in Figure 59. Press the **Set Button** 16 to begin programming the remote for transport punch-through.



Figure 59

4. The next display screen (Figure 60) is where you select the device that will receive the punch-through commands. In our example, that is the TV button, as that is where we want the VCR's transport controls to be active. Press the **▲/▼ Navigation Buttons** 14 until the name of the base device appears and then press the **Set Button** 16.

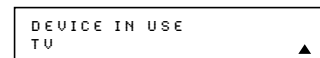

Figure 60

5. At the next display screen (Figure 61), you will select the device whose transport commands will be used. Press the **▲/▼ Navigation Buttons** 14 until the desired device name appears to the right of the device in use. In our example, that is the VCR. When the desired combination of devices appears, press the **Set Button** 16.

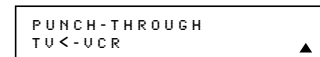

Figure 61

6. When the Set button is pressed, the display will change to show you that the new combination of control commands is being saved to the unit's memory, as shown in Figure 62. The word **SAVED** will flash four times and then the remote will return to normal operation.



Figure 62

- Once the punch-through is programmed, the transport buttons of the second device named will be used when those buttons are pressed while the master device is in use.

Returning the Transport Control Settings to Default Operation:

If you wish to remove the Transport Punch-Through so that the transport commands are returned to the factory default setting, follow the steps shown above, except that in Steps 4 and 5, select the same device for both the **DEVICE IN USE** on the left side of the bottom line and the **PUNCH-THROUGH** device. In the example used, the display to return the remote to default settings will appear as shown in Figure 63.



Figure 63

EzSet Configuration

Harman Kardon's patented EzSet feature makes it easier than ever to calibrate the output levels on your new DPR for maximum playback accuracy. In addition to automatically setting the levels, the DPR remote's LCD display allows the unit to be used as a direct read-out SPL meter. Complete instructions for using the EzSet features of the DPR remote are found on pages 22 and 23 of this owner's manual.

In most cases you will find it easier to access the EzSet capabilities directly by pressing the **SPL Select Button 44** and following the menu prompts as detailed in pages 22 and 23. However, there is one function of the remote that is only available through the remote's menu system being described in this section.

To avoid having the calibration settings created with EzSet changed accidentally, the remote allows you to disable the **SPL Select Button 44** on the remote. To de-activate the button, follow these steps:

- Press and hold the **Program Button 25** for about three seconds while the message shown in Figure 15 appears in the remote's **LCD Information Display 3**. Release the button when the red light under the **Set Button 16** appears.
- The remote's **MAIN MENU** message (Figure 16), will appear in the LCD display and the **Set Button 16** will remain illuminated in red. Press the **▲/▼ Navigation Buttons 14** until **SET SPKR LEVELS** appears on the bottom line of the LCD screen, as shown in Figure 64. Press the **Set Button 16** to enter the main EzSet menu branch.



Figure 64

- At the next menu screen (Figure 65) press the **▲/▼ Navigation Buttons 14** once so that **EZSET DISABLE** appears in the lower line of the LCD display.



Figure 65

- Within five seconds, press the **Set Button 16** to disable the **SPL Select Button 44**. Once the **Set Button 16** is pressed the word **EXITING** will flash four times in the lower line of the LCD display and then it will return to normal operation.

Once these steps are completed, when the **SPL Select Button 44** is pressed the remote will show **EZSET DISABLE** and it will not be activated.

To restore the EzSet feature to normal operation, repeat the procedure outlined above, except that in step #3 you should press the **▲/▼ Navigation Buttons 14** so that **EZSET ENABLE** appears in the lower line of the LCD display. When that display appears, press the **Set Button 16** and the EzSet feature will be reactivated. You may then press the **Clear Button 10** to exit the remote's menu system and return to normal operation or press the **Set Button 16** again to immediately use the EzSet feature to calibrate the system as shown on pages 22 and 23.

Renaming

While the names given to the buttons and inputs on the DPR represent recognizable categories of audio/video products, system operation may be easier if the displays shown in the remote's LCD screen are customized to reflect the specific characteristics of a playback source's brand name or the new function given to a specific button when one remote's controls are programmed into the DPR remote. The DPR remote allows you to change the name of either a master device or any button on the remote using the following steps.

Renaming a Device

To rename a specific device/input source button, follow these steps. For this example, we will show you how to rename the Device/Input Selector normally shown as "TV" to "HDTV TUNER."

- Press and hold the **Program Button 25** for about three seconds while the message shown in Figure 15 appears in the remote's **LCD Information Display 3**. Release the button when the red light under the **Set Button 16** appears.
- The remote's **MAIN MENU** message (Figure 16), will appear in the LCD display and the **Set Button**

- 16** will remain illuminated in red. Press the **▲/▼ Navigation Buttons 14** until **RENAME** appears on the bottom line of the LCD screen, as shown in Figure 66.

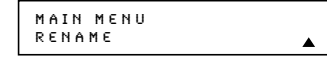

Figure 66

- At the next menu screen press the **▲/▼ Navigation Buttons 14** until **RENAME DEVICE** appears on the bottom line of the LCD screen, as shown in Figure 67. Press the **Set Button 16** to begin renaming a device.

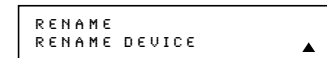

Figure 67

- The next display screen (Figure 68) is where you select the device that will be renamed. In our example, that is the TV button. Press the **▲/▼ Navigation Buttons 14** until the name of the base device appears and then press the **Set Button 16**.



Figure 68

- At the next menu screen you will see the device name on the bottom line of the display with a blinking cursor box to the right of the device name. Press the **◀ Navigation Button 14** to return the blinking cursor to the far left side of the display line. You may then retile the device name as shown in the next step.
- To enter the new name, press the **Numeric Keys 11**. The letters above the numbered buttons indicate which letter or symbol will appear when the button is pressed during the renaming process. The first press of the button will enter the first letter shown, subsequent presses of the same button will change the display to the other letters above that numbered key. For example, since the first letter we need to rename the input to HDTV Tuner is an "H", you would locate the "H" above the "4" button, and press the button twice. The first press shows a "G," the second press changes it to an "H." Consult the table at the end of this section to see which characters pressing a particular button generates.
- After you enter the first letter of the new device name, there are three options for entering the next character:
 - To enter a letter that requires a different numeric key to be pressed, simply press that button. The cursor will automatically move to the next position and the first letter accessed

CONFIGURING THE REMOTE

by the new button will appear. Following our example, the next letter needed is a "D," so you would press the "3" button once.

- b. To enter a letter that uses the same numeric key, you must first press the ► **Navigation Button 14** to move the blinking cursor block to the next position. Then press the **Numeric Key 11** as required to enter the desired letter.
 - c. To enter a blank space, press the ► **Navigation Button 14** twice. The first press will move the cursor to the right, and the second press will move the cursor one more space to the right, leaving a blank space between the last letter and the next one.
8. Repeat Step 7 as needed to enter all the needed letters, numbers, characters and spaces.
 9. When the text entry is complete, press the **Set Button 16**. The LCD display will blink **DEVICE RENAMED** three times and then return to normal operation.

Once a device is renamed you will see the new name on the top line of the remote's LCD display whenever the **Input/Device Selector 4** is pressed, or when any other command/function button on the remote is pressed after the main Device Selector is pressed. Note that renaming a device in the remote will *not* change the name of the input used by the on-screen menu system of the DPR.

NOTES ON RENAMING DEVICES:

- To move the cursor to the right or left of the display during the renaming process, press the ◀/▶ **Navigation Buttons 14** as required.
- The table below shows the letters, numbers and characters that may be accessed by pressing the Numeric Keys:

Key	Characters	Key	Characters
1	[,],/,1	6	M,N,O,6
2	A,B,C,2	7	P,Q,R,S,7
3	D,E,F,3	8	T,U,V,8
4	G,H,I,4	9	W,X,Y,Z,9
5	J,K,L,5	0	-,.,#,0
- Renaming a device changes the name of the device only, not any of the individual key functions within that device memory. To change the name of an individual device, follow the instructions in the next section.

Renaming Individual Keys

Thanks to the programming flexibility of the DPR remote, an individual button on the remote may be assigned a feature or function that is different from the

name that appears as the factory default when the button is pressed. However, with the Rename Key function it is possible to rename almost any button on the remote so that when the button is pressed you will see a more descriptive or appropriate name displayed.

To rename a specific button on the remote, follow these steps. For this example, we will show you how to rename the **Tone Control Button 32**, which is normally not used when DVD is selected so that it reads **ZOOM** in the remote's display.

1. Press and hold the **Program Button 25** for about three seconds while the message shown in Figure 15 appears in the remote's **LCD Information Display 3**. Release the button when the red light under the **Set Button 16** appears.
2. The remote's **MAIN MENU** message (Figure 16), will appear in the LCD display and the **Set Button 16** will remain illuminated in red. Press the ▲/▼ **Navigation Buttons 14** until **RENAME** appears on the bottom line of the LCD screen, as shown in Figure 66.
3. At the next menu screen press the ▲/▼ **Navigation Buttons 14** until **RENAME KEY** appears on the bottom line of the LCD screen, as shown in Figure 69. Press the **Set Button 16** to continue.

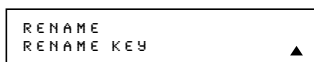

Figure 69

4. The next display screen (Figure 70) is where you select the device within which the key to be renamed exists. Press the ▲/▼ **Navigation Buttons 14** until the name of the base device appears. In our example, since we want to rename a button within the DVD device memory, **DVD** should appear in the lower line of the LCD. When the desired device name appears, press the **Set Button 16**.

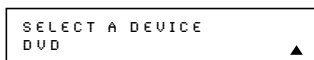

Figure 70

5. At the next menu screen you will select the first button within the device to be renamed, as instructed in the display shown in Figure 71. Select the button by simply pressing it on the remote.

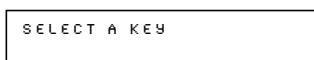

Figure 71

6. Depending on whether or not the button pressed already has a named function within the device selected, one of two things will happen.

- a. If the button to be renamed already has a pre-programmed, or previously renamed title in the remote's memory, you will see that name on the top line of the LCD display, and a blinking block cursor will appear on the far left side of the bottom line of the display, as shown in Figure 72.
- b. If the button to be renamed does not have a function in the device selected, the top line of the LCD screen will be blank, and a blinking block cursor will appear on the far left side of the bottom line of the display, as shown in Figure 73.

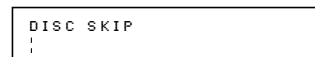

Figure 72



Figure 73

7. To enter the new name for the key, press the **Numeric Keys 11**. The letters above the numbered buttons indicate which letters or symbols will appear when the button is pressed during the renaming process. The first press of the button will enter the first character shown, subsequent presses of the same button will change the display to the other letters above that numbered key. For example, since the first letter we need to rename the Tone button to Zoom is a "Z," so you would locate the "Z" above the "9" button, and press the button four times. The first press shows a "W," the subsequent presses step through the other letters available until the "Z" appears. Consult the table on this page to see which characters are available by pressing a particular button.
8. After you enter the first letter of the new device name, there are three options for entering the next character:

- a. To enter a letter that requires a different numeric key to be pressed, simply press that button. The cursor will automatically move to the next position and the first letter accessed by the new button will appear. Following our example, the next letter needed is an "O," so you would press the "6" button once.
- b. To enter a letter that uses the same numeric key, you must first press the ► **Navigation Button 14** to move the blinking cursor block

to the next position. Then press the **Numeric Key 11** as required to enter the desired letter. This is the way you would enter the second "O" in the word ZOOM, and again for the letter "M."

c. To enter a blank space, press the **Navigation Button 14** twice. The first press will move the cursor to the right, and the second press will move the cursor one more space to the right, leaving a blank space between the last letter and the next one.

9. Repeat Steps 7 and 8 as needed to complete entering the needed letters, numbers, characters and spaces.

10. When the text entry is complete, press the **Set Button 16**. The new name will be entered into the remote's memory, replacing the default name.

11. At this point you have two options:

- If you wish to program an additional key within the same device, press the **Set Button 16** as instructed by the bottom line of the LCD display reading **ANOTHER KEY**. The remote will return to the **SELECT A KEY** menu option as shown in Step 6. Repeat the instructions in Steps 6 through 11 to rename the next key.
- If you have no additional keys to rename, press the **Navigation Button 14** once so that the menu screen displays **EXIT** on the bottom line of the display. Press the **Set Button 16** to return the remote to normal operation.

NOTES ON RENAMING KEYS:

- Renaming a key does not change its function. You may change the function of an individual key by learning a new code into the remote. See page 34 for more information.
- When a key is renamed it will only apply to the specific device selected in Step 4. The same key may be renamed as needed for each individual device with which it is used.

Resetting the Remote

Depending on the way in which the remote has been programmed, there may be a situation where you wish to totally erase all changes that have been made to the remote and return it to the factory defaults. You may do that by following the steps shown below, but remember that once the remote is reset, ALL changes that have been made, including programming for use with other devices, learned keys, macros, punch-through settings and key names, will be erased and any settings you had previously made will have to be reentered.

To erase all settings and reset the remote to the original factory default settings and displays, follow these steps:

- Press and hold the **Program Button 25** for about three seconds while the message shown in Figure 15 appears in the remote's **LCD Information Display 3**. Release the button when the red light under the **Set Button 16** appears.
- The remote's **MAIN MENU** message (Figure 16), will appear in the LCD display and the **Set Button 16** will remain illuminated in red. Press the **Navigation Buttons 14** until **USER RESET** appears on the bottom line of the LCD screen, as shown in Figure 74.

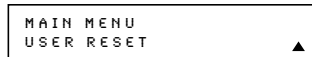

Figure 74

- Press the **Set Button 16** to reset the remote. Note that once the Set Button is pressed the process may not be stopped. While the remote's memory is being cleared a **RESETTING...** message will appear in the upper line of the remote's LCD screen as shown in Figure 75. It may take a few minutes for the reset process to take place, and the length of time will vary depending on how much customization and programming has taken place. Please be patient; as long as the message appears in the display the remote is functioning properly.



Figure 75

- When the remote has been totally reset and returned to the factory default condition, a **REMOTE RESET COMPLETE** message will appear (Figure 76) briefly, and then the remote will return to normal operation.



Figure 76

Additional Notes on Configuring and Operating the Remote:

- When the remote is being programmed, it will automatically time-out if no button is pressed within a thirty-second period. The message shown in Figure 77 will appear briefly, and the remote will then exit the feature being programmed and any data entered will be lost.

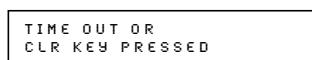

Figure 77

- The programming or configuration process may also be stopped at any time by pressing the **Clear Button 10**. The message shown in Figure 77 will appear, the data entered in the current process will be lost and the remote will return to normal operation. Any process that was underway when the button will be pressed must be re-started.
- Extensive use of the programming, learning and configuration functions of the remote may consume significantly more battery power than normal remote operation. While the batteries should last for four to six months in normal operation, you may find that they need to be changed sooner after the remote is programmed for the first time.
- When the batteries approach a level below which the remote will not function, the remote's LCD screen will display a **LOW BATTERY** warning as shown in Figure 78. We strongly recommend replacing the batteries as soon as this message appears to avoid the loss of programming and configuration settings. These settings are *not* lost when the batteries are changed quickly.

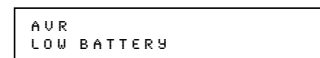

Figure 78

- The remote has a built-in backlight that may be activated by pressing the **Light Button 26**. This button is made from a special "glow" material so that it is easier to find in dark rooms. This glow feature does not consume any electricity, but the glow will fade when the remote is kept in a dark location for an extended period of time. The "glow" feature may be restored by placing the remote in normal room light for a few hours.
- The remote's backlight will remain lit for approximately five seconds after the **Light Button 26** is pressed, and it will stay lit for another five seconds if any key is pressed while the backlight is on. You may keep the backlight lit by holding the Light Button, but extensive use of the backlight will reduce battery life.
- The LCD display will remain on for ten seconds after a key is pressed and then turn off to conserve battery life.
- When any button is held for more than thirty seconds the LCD will turn off and the remote will stop transmitting the codes to conserve battery life.

TROUBLESHOOTING GUIDE

SYMPTOM	CAUSE	SOLUTION
Unit does not function when Main Power Switch is pushed.	<ul style="list-style-type: none"> No AC Power 	<ul style="list-style-type: none"> Make certain AC power cord is plugged into a live outlet. Check to see whether outlet is switch-controlled.
Display lights, but there is no sound or picture.	<ul style="list-style-type: none"> Intermittent input connections Mute is on Volume control is down 	<ul style="list-style-type: none"> Make certain that all input and speaker connections are secure. Press Mute button. Turn up volume control.
Unit turns on, but front panel display does not light up.	<ul style="list-style-type: none"> Display brightness is turned off 	<ul style="list-style-type: none"> Follow the instructions in the Display Brightness section on page 30 so that the display is set to VFD FULL.
No sound from any speaker; light around power switch is red.	<ul style="list-style-type: none"> Amplifier is in protection mode due to possible short Amplifier is in protection mode due to internal problems 	<ul style="list-style-type: none"> Check speaker wire connections for shorts at receiver and speaker ends. Contact your local Harman Kardon service center.
No sound from surround or center speakers.	<ul style="list-style-type: none"> Incorrect surround mode Input is monaural Incorrect configuration 	<ul style="list-style-type: none"> Select a mode other than Stereo. There is no surround information from mono sources. Check speaker configuration. (See pages 19–21.)
Receiver does not play correct soundtrack from DTS or Dolby Digital DVDs.	<ul style="list-style-type: none"> DVD disc or player menus set incorrectly 	<ul style="list-style-type: none"> Check the setup menu in your DVD player or the "Audio" menu in the disc being played to make certain that the player is set for the desired output signal.
Unit does not respond to remote commands.	<ul style="list-style-type: none"> Weak batteries in remote Wrong device selected Remote sensor is obscured 	<ul style="list-style-type: none"> Change remote batteries. Press the AVR selector. Make certain front panel sensor is visible to remote, or connect remote sensor.
Intermittent buzzing in tuner.	<ul style="list-style-type: none"> Local interference 	<ul style="list-style-type: none"> Move unit or antenna away from computers, fluorescent lights, motors or other electrical appliances.
Speaker Channel Input indicators flash and digital audio stops.	<ul style="list-style-type: none"> Digital audio feed paused 	<ul style="list-style-type: none"> Resume play for DVD. Check that Digital Input is selected.

Processor Reset

In the rare case in which the unit's operation or the displays seem abnormal, the cause may involve the erratic operation of the system's memory or microprocessor.

To correct this problem, first unplug the unit from the AC wall outlet and wait at least three minutes. After the pause, reconnect the AC power cord and check the unit's operation. If the system still malfunctions, a system reset may clear the problem.

To totally reset the DPR 1001's processor and clear all setting and configuration data, including all tuner presets, output level settings, delay times, surround mode choices, speaker configuration and crossover data, follow these steps:

1. Turn the unit completely off by pressing the **Main Power Switch 19** so that it is in the OFF position.

2. Press and hold the **Tuning Mode Selector 7** and the **Tuning ▼ Button 8**, and at the same time press the **Main Power Switch 19** in so that it is in the ON position.
3. When the **Upper Display Line F** reads **RESET**, release the **Tuning Mode Selector 7** and **Tuning ▼ Button 8**.
4. After a few seconds the unit will go into a display test mode that will illuminate all segments of the **Main Information Display 16**.
5. Press the **Standby/On Button 2** to return the DPR to normal operation.

When the reset is complete you may return to normal operation, but remember that all system configuration settings and tuner presets will have to be reentered.

NOTE: Resetting the processor will erase any configuration settings you have made for speakers, output levels, surround modes and digital input assignments,

as well as the tuner presets. After a reset, the unit will be returned to the factory presets, and all settings for these items must be reentered.

If the system is still operating incorrectly, there may have been an electronic discharge or severe AC line interference that has corrupted the memory or microprocessor.

If these steps do not solve the problem, consult an authorized Harman Kardon service center.

DPR 1001 TECHNICAL SPECIFICATIONS

Audio Section

Continuous Average Power (FTC)

All Channels: 50 Watts per channel @ 8 ohms, 1kHz, 0.19% THD

Power Output per EIA 490A: 65 Watts x 7 @ 8 ohms

Input Sensitivity/Impedance

Linear (High-Level) 200mV/47k ohms

Signal-to-Noise Ratio (IHF-A) 90dB

Surround System Adjacent Channel Separation

Pro Logic I, II 40dB

Dolby Digital 55dB

DTS 55dB

Frequency Response

@ 1W (+0dB, -3dB) 20Hz - 22kHz

Transient Intermodulation

Distortion (TIM) None

Negative Feedback None

FM Tuner Section

Frequency Range 87.5MHz - 108MHz

Usable Sensitivity IHF 1.3µV/13.2dBf

Signal-to-Noise Ratio Mono/Stereo 70dB/68dB

Distortion Mono/Stereo 0.2%/0.3%

Stereo Separation 40dB @ 1kHz

Selectivity ±400kHz, 70dB

Image Rejection 80dB

IF Rejection 90dB

AM Tuner Section

Frequency Range 520kHz - 1710kHz

Signal-to-Noise Ratio 45dB

Usable Sensitivity Loop 500µV

Distortion 1kHz, 50% Mod 0.8%

Selectivity ±10kHz, 30dB

Video Section

Television Format NTSC

Input Level/Impedance 1Vp-p/75 ohms

Output Level/Impedance 1Vp-p/75 ohms

Video Frequency Response (Composite and S) 10Hz - 8MHz (-3dB)

Video Frequency Response (Component) 10Hz - 30MHz (-3dB)

General

Power Requirement AC 120V/60Hz

Power Consumption 7.6W standby, 550W @ rated output, all channels driven

Dimensions Width 17.3 inches (440mm)

Height 4.75 inches (120mm)

Depth 18.75 inches (476mm)

Weight 17 lb (7.7kg)

Depth measurement includes knobs, buttons and terminal connections.

Height measurement includes feet and chassis.

All features and specifications are subject to change without notice.

Harman Kardon and Power for the Digital Revolution are registered trademarks of Harman International Industries, Incorporated.

ExSet is a trademark of Harman International Industries, Incorporated (patent no. 5,386,478).

*Manufactured under license from Dolby Laboratories.

"Dolby," "Pro Logic" and the Double-D symbol are trademarks of Dolby Laboratories. Confidential Unpublished Works. ©1992-1999 Dolby Laboratories, Inc. All rights reserved.

Surround EX is a jointly developed technology of THX and Dolby Laboratories, Inc., and is a trademark of Dolby. Used under authorization.

DTS, DTS Surround, DTS-ES and DTS Neo:6 are trademarks of Digital Theater Systems, Inc.

Cirrus and Cirrus Logic are trademarks of Cirrus Logic Inc.

VMAx is a registered trademark of Harman International Industries, Incorporated, and is an implementation of Cooper Bauck Transaural Stereo under patent license.

Logic 7 is a registered trademark of Harman International Industries, Incorporated.

TiVo is a registered trademark of TiVo, Inc.

ReplayTV is a registered trademark of SONICblue, Inc.

harman/kardon®



H A Harman International Company
250 Crossways Park Drive, Woodbury, New York 11797
www.harmankardon.com
© 2003 Harman International Industries, Incorporated
Part No.: YIAR-L2000-01A

Free Manuals Download Website

<http://myh66.com>

<http://usermanuals.us>

<http://www.somanuals.com>

<http://www.4manuals.cc>

<http://www.manual-lib.com>

<http://www.404manual.com>

<http://www.luxmanual.com>

<http://aubethermostatmanual.com>

Golf course search by state

<http://golfingnear.com>

Email search by domain

<http://emailbydomain.com>

Auto manuals search

<http://auto.somanuals.com>

TV manuals search

<http://tv.somanuals.com>