

Grizzly **Industrial, Inc.**®

MODEL G0631 79" X 28" DOWNDRAFT TABLE OWNER'S MANUAL



COPYRIGHT © FEBRUARY, 2007 BY GRIZZLY INDUSTRIAL, INC.
**WARNING: NO PORTION OF THIS MANUAL MAY BE REPRODUCED IN ANY SHAPE
OR FORM WITHOUT THE WRITTEN APPROVAL OF GRIZZLY INDUSTRIAL, INC.**
#BL8792 PRINTED IN TAIWAN

WARNING!

This manual provides critical safety instructions on the proper setup, operation, maintenance and service of this machine/equipment.

Failure to read, understand and follow the instructions given in this manual may result in serious personal injury, including amputation, electrocution or death.

The owner of this machine/equipment is solely responsible for its safe use. This responsibility includes but is not limited to proper installation in a safe environment, personnel training and usage authorization, proper inspection and maintenance, manual availability and comprehension, application of safety devices, blade/cutter integrity, and the usage of personal protective equipment.

The manufacturer will not be held liable for injury or property damage from negligence, improper training, machine modifications or misuse.

WARNING!

Some dust created by power sanding, sawing, grinding, drilling, and other construction activities contains chemicals known to the State of California to cause cancer, birth defects or other reproductive harm. Some examples of these chemicals are:

- **Lead from lead-based paints.**
- **Crystalline silica from bricks, cement and other masonry products.**
- **Arsenic and chromium from chemically-treated lumber.**

Your risk from these exposures varies, depending on how often you do this type of work. To reduce your exposure to these chemicals: Work in a well ventilated area, and work with approved safety equipment, such as those dust masks that are specially designed to filter out microscopic particles.

Table of Contents

INTRODUCTION.....	2
Foreword	2
Contact Info.....	2
Machine Data Set.....	3
Identification	4
SECTION 1: SAFETY	5
Safety Instructions for Machinery.....	5
SECTION 2: CIRCUIT REQUIREMENTS	8
110V Operation	8
SECTION 3: SETUP	9
Setup Safety.....	9
Items Needed for Setup	9
Unpacking	9
Inventory.....	10
Hardware Recognition Chart.....	11
Site Considerations	12
Moving & Placing Base Unit.....	12
Assembly.....	13
Test Run.....	15
SECTION 4: OPERATIONS	16
Operation Safety	16
Dust Drawers	16
Operation.....	16
SECTION 5: ACCESSORIES	17
SECTION 6: MAINTENANCE	19
Schedule	19
Cleaning	19
Filters.....	19
SECTION 7: SERVICE	20
Troubleshooting.....	20
Electrical Components	21
Wiring Diagram	22
Parts Breakdown.....	23
Parts List	24
Safety Label Placement and Parts List.....	25
WARRANTY AND RETURNS	26

INTRODUCTION

Foreword

We are proud to offer the Model G0631 79" x 28" Downdraft Table. This machine is part of a growing Grizzly family of fine woodworking machinery. When used according to the guidelines set forth in this manual, you can expect years of trouble-free, enjoyable operation and proof of Grizzly's commitment to customer satisfaction.

The specifications, drawings, and photographs illustrated in this manual represent the Model G0631 when the manual was prepared. However, owing to Grizzly's policy of continuous improvement, changes may be made at any time with no obligation on the part of Grizzly.

For your convenience, we always keep current Grizzly manuals available on our website at **www.grizzly.com**. Any updates to your machine will be reflected in these manuals as soon as they are complete. Visit our site often to check for the latest updates to this manual!

Contact Info

If you have any comments regarding this manual, please write to us at the address below:

Grizzly Industrial, Inc.
c/o Technical Documentation Manager
P.O. Box 2069
Bellingham, WA 98227-2069
Email: manuals@grizzly.com

We stand behind our machines. If you have any service questions or parts requests, please call or write us at the location listed below.

Grizzly Industrial, Inc.
1203 Lycoming Mall Circle
Muncy, PA 17756
Phone: (570) 546-9663
Fax: (800) 438-5901
E-Mail: techsupport@grizzly.com
Web Site: <http://www.grizzly.com>





MACHINE DATA SHEET

Customer Service #: (570) 546-9663 • To Order Call: (800) 523-4777 • Fax #: (800) 438-5901

MODEL G0631 79" X 28" VACUUM SANDING TABLE

Overall Dimensions:

Table Size	25¼" L X 76¼" W
Table Height	31½"
Overall Size	27¾" L x 78¾" W x 39¾" H
Base Footprint	27¾" L x 78¾" W
Shipping Weight	486 lbs.
Net Weight	442 lbs.
Crate Size	28¾" L x 80¼" W x 41" H

Capacities:

Air Suction Capacity Per Side With Filters	1076 CFM
First Stage Filter Micron	1
First Stage Efficiency	70%
Second Stage Filter Micron	0.3
Second Stage Efficiency	85%
Number of Impellers	2
Impeller Type	Aluminum Squirrel Cage
Impeller Inlet Size	9"
Impeller Squirrel Cage Size	9½" x 10½"
Outlet Size	9⅞" x 13"
Operating Sound Level	68 dB

Construction:

Table	Formed Steel
Table Top	Formed Steel with Non-Marring Rubber Grommets
Paint	Powder Coated

Motors:

Number of Motors	2
Horsepower Per Motor	1 HP
Type	ODP Capacitor Start Induction
Phase / Voltage	1-Phase / 110V
Amps per Motor	12A
Speed	1175 RPM
Cycle	60 Hz
Number of Speeds	1
Power Transfer	Direct Drive
Bearings	Shielded and Lubricated

Switch Information:

Switch	Grizzly Toggle with Lockout Key
Cord Length	12 ft.
Plug	Yes

Filter Information:

Number of First Stage Filters	2
First Stage Dimensions	16" L x 25" W x 1" H
Number of Second Stage Filters	2
Second Stage Dimensions	16" L x 25" W x 2" H

Features:

.....	Non-Marring Rubber Grommets Support Workpiece
.....	Durable Powder Coated Paint
.....	Sheet Metal Table Construction
.....	Two Convenient Dust Drawers
.....	Quiet Operation



Identification



Figure 1. Identification, Model G0631.

- A. Left Panel
- B. Center Panels
- C. Downdraft Plates
- D. Right Panel
- E. ON/OFF Switch
- F. Dust Drawer
- G. Outlet Plates



SECTION 1: SAFETY

WARNING

For Your Own Safety, Read Instruction Manual Before Operating this Machine

The purpose of safety symbols is to attract your attention to possible hazardous conditions. This manual uses a series of symbols and signal words intended to convey the level of importance of the safety messages. The progression of symbols is described below. Remember that safety messages by themselves do not eliminate danger and are not a substitute for proper accident prevention measures.



Indicates an imminently hazardous situation which, if not avoided, **WILL** result in death or serious injury.



Indicates a potentially hazardous situation which, if not avoided, **COULD** result in death or serious injury.



Indicates a potentially hazardous situation which, if not avoided, **MAY** result in minor or moderate injury. It may also be used to alert against unsafe practices.

NOTICE

This symbol is used to alert the user to useful information about proper operation of the machine.

WARNING

Safety Instructions for Machinery

- 1. READ THE ENTIRE MANUAL BEFORE STARTING MACHINERY.** Machinery presents serious injury hazards to untrained users.
- 2. ALWAYS USE ANSI APPROVED SAFETY GLASSES WHEN OPERATING MACHINERY.** Everyday eyeglasses only have impact resistant lenses—they are NOT safety glasses.
- 3. ALWAYS WEAR A NIOSH APPROVED RESPIRATOR WHEN OPERATING MACHINERY THAT PRODUCES DUST.** Wood dust can cause severe respiratory illnesses.
- 4. ALWAYS USE HEARING PROTECTION WHEN OPERATING MACHINERY.** Machinery noise can cause permanent hearing loss.
- 5. WEAR PROPER APPAREL. DO NOT** wear loose clothing, gloves, neckties, rings, or jewelry that can catch in moving parts. Wear protective hair covering to contain long hair and wear non-slip footwear.
- 6. NEVER OPERATE MACHINERY WHEN TIRED OR UNDER THE INFLUENCE OF DRUGS OR ALCOHOL.** Be mentally alert at all times when running machinery.



WARNING

Safety Instructions for Machinery

7. **ONLY ALLOW TRAINED AND PROPERLY SUPERVISED PERSONNEL TO OPERATE MACHINERY.** Make sure operation instructions are safe and clearly understood.
8. **KEEP CHILDREN AND VISITORS AWAY.** Keep all children and visitors a safe distance from the work area.
9. **MAKE WORKSHOP CHILDPROOF.** Use padlocks, master switches, and remove start switch keys.
10. **NEVER LEAVE WHEN MACHINE IS RUNNING.** Turn power **OFF** and allow all moving parts to come to a complete stop before leaving machine unattended.
11. **DO NOT USE IN DANGEROUS ENVIRONMENTS.** DO NOT use machinery in damp, wet locations, or where any flammable or noxious fumes may exist.
12. **KEEP WORK AREA CLEAN AND WELL LIGHTED.** Clutter and dark shadows may cause accidents.
13. **USE A GROUNDED EXTENSION CORD RATED FOR THE MACHINE AMPERAGE.** Grounded cords minimize shock hazards. Undersized cords create excessive heat. Always replace damaged extension cords.
14. **ALWAYS DISCONNECT FROM POWER SOURCE BEFORE SERVICING MACHINERY.** Make sure switch is in OFF position before reconnecting.
15. **MAINTAIN MACHINERY WITH CARE.** Keep blades sharp and clean for best and safest performance. Follow instructions for lubricating and changing accessories.
16. **MAKE SURE GUARDS ARE IN PLACE AND WORK CORRECTLY BEFORE USING MACHINERY.**
17. **REMOVE ADJUSTING KEYS AND WRENCHES.** Make a habit of checking for keys and adjusting wrenches before turning machinery **ON**.
18. **CHECK FOR DAMAGED PARTS BEFORE USING MACHINERY.** Check for binding or misaligned parts, broken parts, loose bolts, and any other conditions that may impair machine operation. Repair or replace damaged parts before operation.
19. **USE RECOMMENDED ACCESSORIES.** Refer to the instruction manual for recommended accessories. Improper accessories increase risk of injury.
20. **DO NOT FORCE MACHINERY.** Work at the speed for which the machine or accessory was designed.
21. **SECURE WORKPIECE.** Use clamps or a vise to hold the workpiece when practical. A secured workpiece protects your hands and frees both hands to operate the machine.
22. **DO NOT OVERREACH.** Maintain stability and balance at all times.
23. **MANY MACHINES CAN EJECT WORKPIECES TOWARD OPERATOR.** Know and avoid conditions that cause the workpiece to "kickback."
24. **ALWAYS LOCK MOBILE BASES (IF USED) BEFORE OPERATING MACHINERY.**
25. **CERTAIN DUST MAY BE HAZARDOUS** to the respiratory systems of people and animals, especially fine dust. Be aware of the type of dust you are exposed to and always wear a respirator designed to filter that type of dust.



WARNING

Additional Safety for Downdraft Tables

- 1. FILTER CAPABILITIES.** This downdraft table is to be used for wood dust collection only. DO NOT use this machine to filter or collect liquids (especially flammables), metal shavings, lead paint, or asbestos or collect burning or smoking material, including matches, cigarettes, and hot ashes. DO NOT use this machine to dissipate smoke or fumes.
- 2. IMPELLER EXPOSURE.** Always operate the machine with the filters in place. Unplug the machine before removing the filters.
- 3. MAINTENANCE/SERVICE.** Problems concerned with any moving parts or accessories MUST be investigated and corrected with the power disconnected and after everything has come to a complete stop.
- 4. EXPLOSION RISK.** Suspended dust particles in conjunction with an ignition source may cause an explosion. Do not operate this machine in areas where explosion risks would be high if dust were dispersed into the area. Areas of high risk include, but are not limited to, areas near pilot lights or open flames. NEVER use this downdraft table where paint fumes exist, or within a paint spray booth.
- 5. EMPTYING DUST DRAWER.** When emptying dust from the dust drawers, wear a respirator and safety glasses. Empty dust into an approved container and dispose properly.
- 6. WOOD TOXICITY.** Research the dangers of the specific species of wood you are working with as dust from some woods are toxic and can make you sick, cause cancer, and lead to long-term respiratory problems.
- 7. LEAD AND ASBESTOS.** This machine will not protect against lead-paint dust or asbestos fibers. These materials must be collected with special equipment because of the high hazard to human health. DO NOT attempt to collect these materials with this machine.
- 8. EXPERIENCING DIFFICULTIES.** If at any time you are experiencing difficulties performing the intended operation, stop using the machine! Contact our Technical Support Department at (570) 546-9663.

WARNING

Like all machines there is danger associated with this machine. Accidents are frequently caused by lack of familiarity or failure to pay attention. Use this machine with respect and caution to lessen the possibility of operator injury. If normal safety precautions are overlooked or ignored, serious personal injury may occur.

CAUTION

No list of safety guidelines can be complete. Every shop environment is different. Always consider safety first, as it applies to your individual working conditions. Use this and other machinery with caution and respect. Failure to do so could result in serious personal injury, damage to equipment, or poor work results.



SECTION 2: CIRCUIT REQUIREMENTS

110V Operation

!WARNING

Serious personal injury could occur if you connect the machine to the power source before you have completed the set up process. **DO NOT** connect the machine to the power source until instructed to do so.

Amperage Draw

Each Model G0631 motor draws the following amps under maximum load:

Motor Draw 12 Amps

Circuit Recommendations

We recommend connecting EACH motor to a dedicated and grounded circuit that is rated for the amperage given below. Never replace a circuit breaker on an existing circuit with one of higher amperage without consulting a qualified electrician to ensure compliance with wiring codes. **If you are unsure about the wiring codes in your area or you plan to connect your machine to a shared circuit, consult a qualified electrician.**

110V Circuit..... 15 Amps (Each Motor)

Plug/Receptacle Type

Included Plug Type..... NEMA 5-15

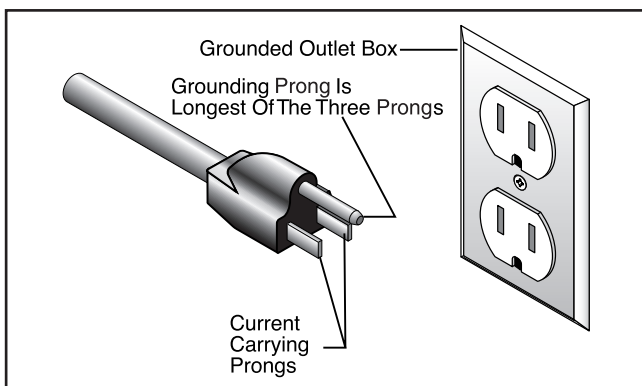

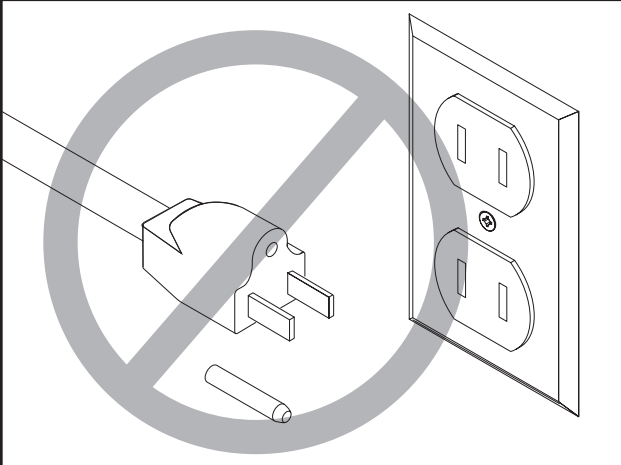

Figure 2. Typical type 5-15 plug and receptacle.



!WARNING
Electrocution or fire could result if this machine is not grounded correctly or if your electrical configuration does not comply with local and state codes. Ensure compliance by checking with a qualified electrician!



!CAUTION
This machine must have a ground prong in the plug to help ensure that it is grounded. **DO NOT** remove ground prong from plug to fit into a two-pronged outlet! If the plug will not fit the outlet, have the proper outlet installed by a qualified electrician.

Extension Cords

We do not recommend the use of extension cords, but if you find it absolutely necessary:

- Use at least a 14 gauge cord that does not exceed 50 feet in length!
- The extension cord must also contain a ground wire and plug pin.
- A qualified electrician **MUST** size cords over 50 feet long to prevent motor damage.



SECTION 3: SETUP

Setup Safety

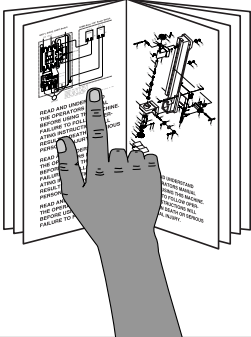

!WARNING
This machine presents serious injury hazards to untrained users. Read through this entire manual to become familiar with the controls and operations before starting the machine!



!WARNING
Wear safety glasses during the entire set up process!



!WARNING
The Model G0631 is a heavy machine. DO NOT over-exert yourself while unpacking or moving your machine—get assistance.

Items Needed for Setup

The following items are needed to complete the setup process, but are not included with your machine:

Description	Qty
• Assistant for Lifting Help	As Needed
• Safety Glasses (for each person)	1
• Phillips Screwdriver #2	1

Unpacking

The Model G0631 was carefully packed when it left our warehouse. If you discover the machine is damaged after you have signed for delivery, *please immediately call Customer Service at (570) 546-9663 for advice.*

Save the containers and all packing materials for possible inspection by the carrier or its agent. *Otherwise, filing a freight claim can be difficult.*

When you are completely satisfied with the condition of your shipment, inventory the contents.



Inventory

After all the parts have been removed from the box and inside of the downdraft table, you should have the following items:

Box 1: (Figure 3)	Qty
A. Downdraft Table (Not Shown)	1
B. Left Center Panel	1
C. Right Center Panel	1
D. Filters 16" x 25" x 2" (0.3 micron).....	2
E. Filters 16" x 25" x 1" (1 micron)	2
F. Downdraft Plates	10
G. Center Downdraft Plate	1
H. Right Panel.....	1
I. Left Panel	1
J. Hardware (Not Shown)	
—Pins (Panels)	8
—Handles (Outlet Plate)	2
—Phillips Head Screws 1/4"-20 x 5/8" (Outlet Plate).....	4

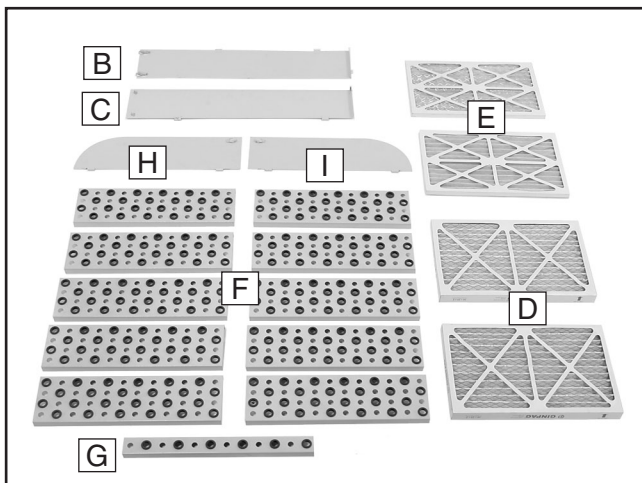

Figure 3. Model G0631 inventory.

If any nonproprietary parts are missing (e.g. a nut or a washer), we will gladly replace them; or for the sake of expediency, replacements can be obtained at your local hardware store.

NOTICE

Some hardware/fasteners on the inventory list may arrive pre-installed. Check mounting locations before assuming that any items from the inventory list are missing.



WARNING

SUFFOCATION HAZARD!
Immediately discard all plastic bags and packing materials to eliminate choking/suffocation hazards for children and animals.



Hardware Recognition Chart

USE THIS CHART TO MATCH UP HARDWARE DURING THE ASSEMBLY PROCESS.

MEASURE BOLT DIAMETER BY PLACING INSIDE CIRCLE

- #10
- 1/4"
- 5/16"
- 3/8"
- 7/16"
- 1/2"

- 4mm
- 6mm
- 8mm
- 10mm
- 12mm
- 16mm

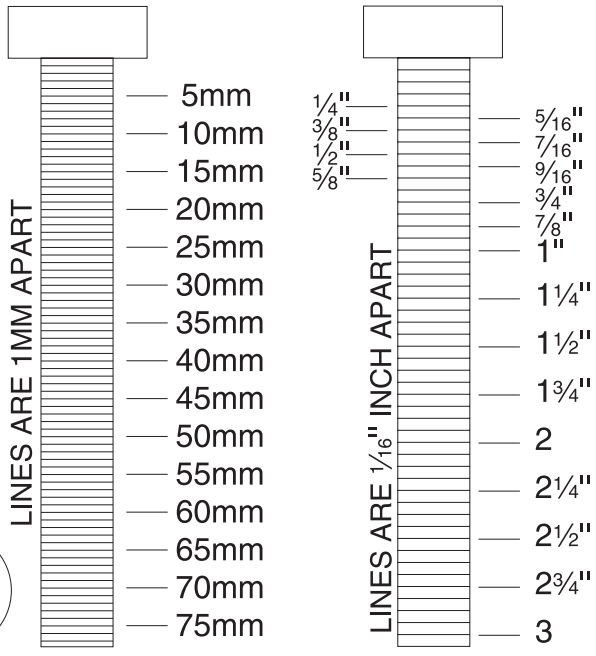
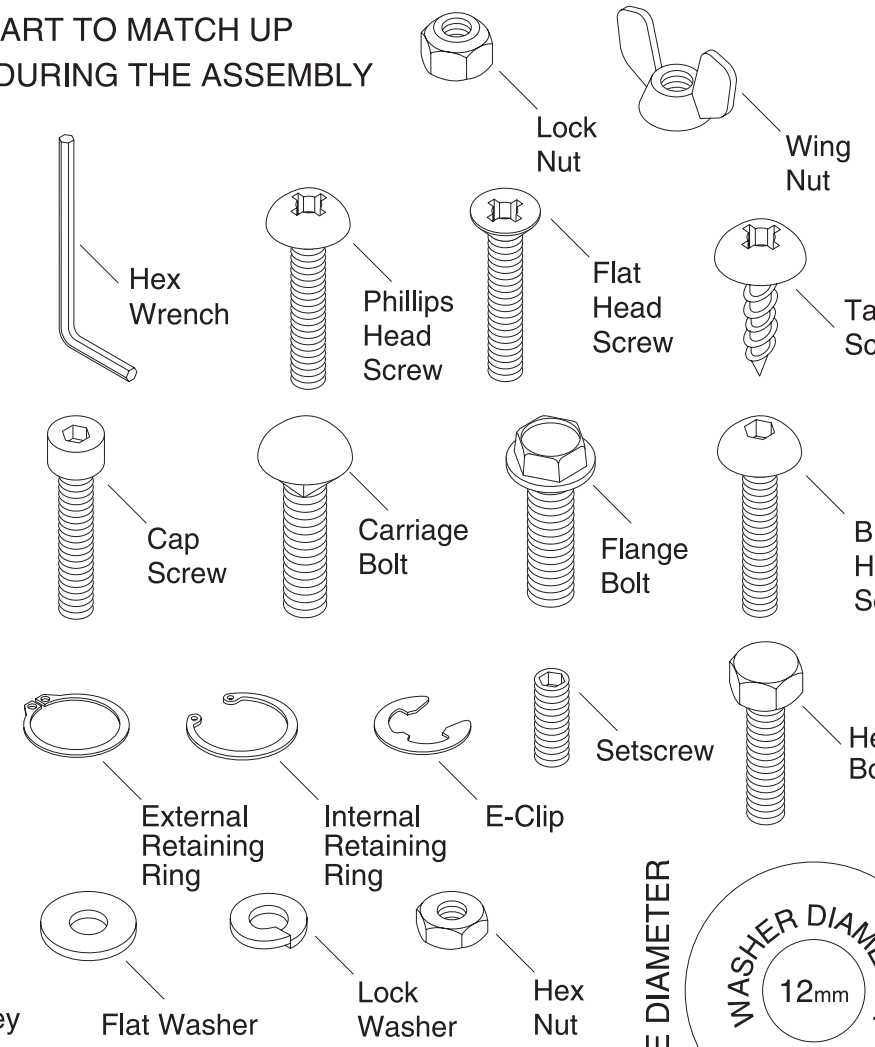

WASHERS ARE MEASURED BY THE INSIDE DIAMETER

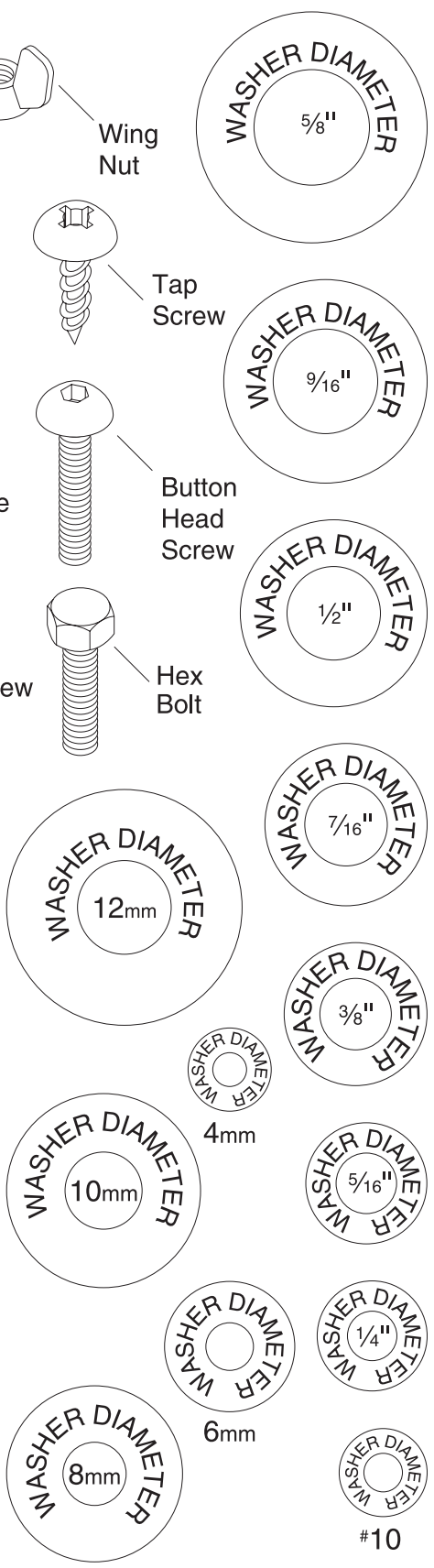

Site Considerations

Floor Load

Refer to the **Machine Data Sheet** on **Page 3** for the weight and footprint specifications of your machine. Some residential floors may require additional reinforcement to support both the machine and operator.

Placement Location

Consider existing and anticipated needs, size of material to be processed through each machine, and space for auxiliary stands, work tables or other machinery when establishing a location for your new machine. See **Figure 4** for the minimum working clearances.

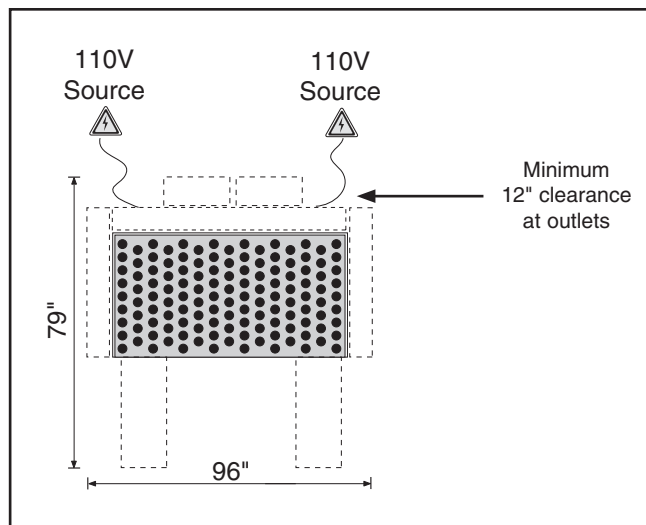

Figure 4. Minimum working clearances.



Moving & Placing Base Unit



Use a forklift to lift the machine to a suitable location, and with the help of several people, place the downdraft table into position on the floor.

Assembly

Components and Hardware Needed:	Qty
Filters 16" x 25" x 1"	2
Filters 16" x 25" x 2"	2
Downdraft Plates	10
Center Downdraft Plate	1
Pins	8
Left Center Panel	1
Right Center Panel	1
Left Panel	1
Right Panel	1
Handles	2
Phillips Head Screws 1/4"-20 x 5/8"	2

To assemble the downdraft table:

1. Install the 2" thick filters in the filter bay on both sides of the downdraft table cabinet as shown in **Figure 5**, then install the 1" thick filters in front of them.

Note: Be sure to remove the plastic wrapping from the filters before installing. Also, to ensure that the filters function correctly, orient the filters so the metal webbing points toward the impeller.

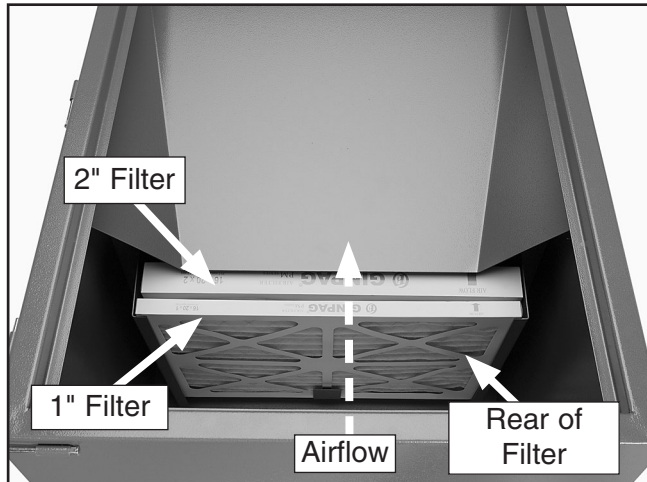

Figure 5. Filters installed in filter bay (one side shown).

2. Install the downdraft plates as shown in **Figure 6**, placing the thinner center downdraft plate in the middle.

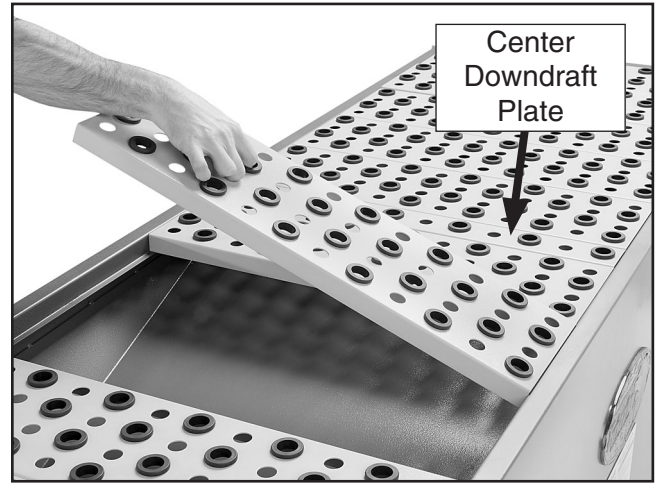

Figure 6. Installing downdraft plates.

3. Align the right and left center panels with the rear downdraft table hinges, and secure with four pins as shown in **Figure 7**.

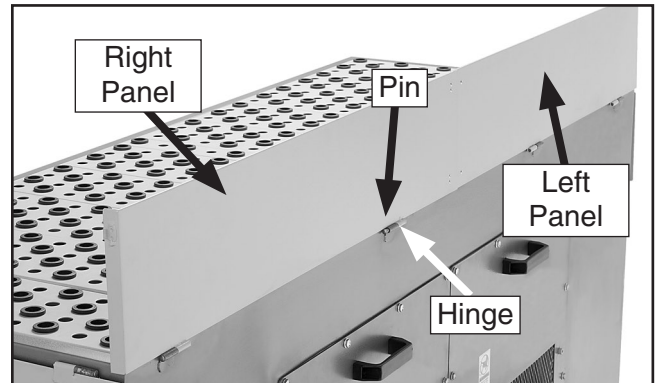

Figure 7. Center panels installed.

4. Fasten the center panels in the middle with the latches.

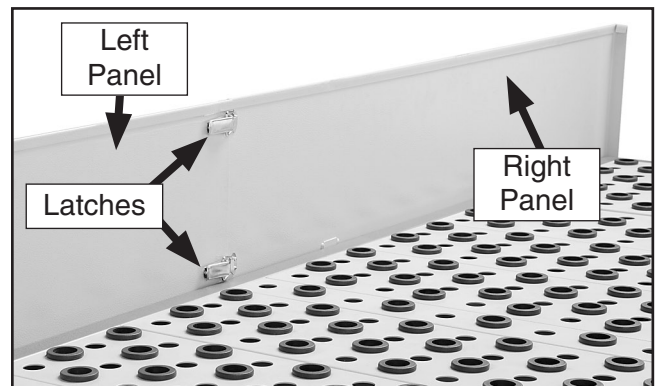

Figure 8. Center panels secured with latches.

- Secure the right and left panels with the remaining pins (**Figure 9**).

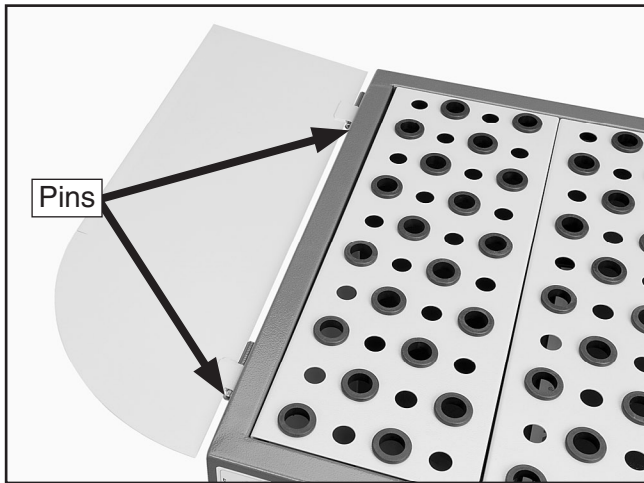

Figure 9. Left panel installed.

- With the side panels in the upright position, slide the center panel brackets (**Figure 10**) over the side panels and secure with the latches.

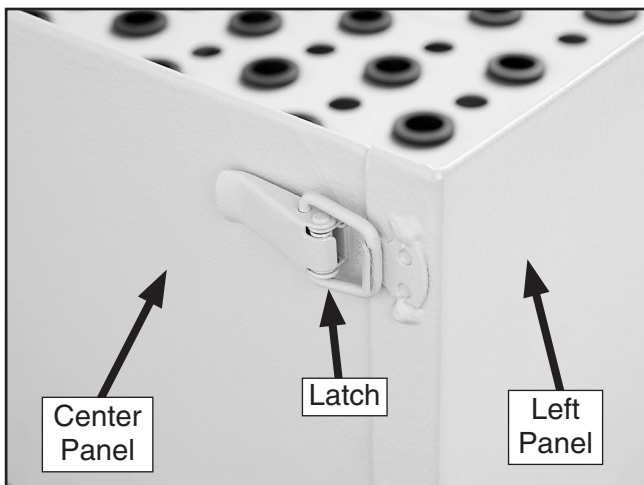

Figure 10. Panels secured with latches (one shown).

- Using $\frac{1}{4}$ "-20 x $\frac{5}{8}$ Phillips head screws, mount the handles on the outlet plates at the rear of the downdraft table as shown in **Figure 11**.

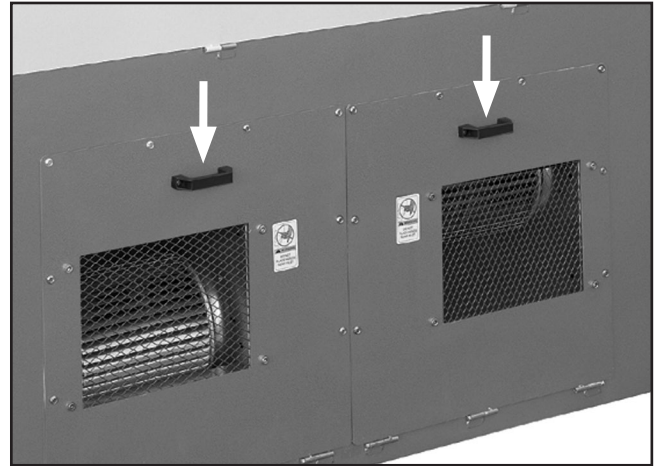

Figure 11. Outlet plate handles mounted.

Test Run

Once the assembly is complete, test run your downdraft table to make sure it runs properly and verify safety features are in working order.

If, during the test run, you cannot easily locate the source of an unusual noise or vibration, stop using the machine immediately, then review the **Troubleshooting** on **Page 20**.

If you still cannot remedy a problem, contact our Tech Support at (570) 546-9663 for assistance.

To test run the downdraft table:

1. Ensure that anyone in the vicinity of the downdraft table, including yourself, is wearing safety glasses.
2. Make sure you have read the safety instructions at the beginning of the manual and that the machine is set up properly.
3. Connect EACH motor to a dedicated 110V circuit (see **CIRCUIT REQUIREMENTS, Page 8**).

4. Flip both paddle switches up to turn the downdraft table **ON**. Make sure that your hand stays poised over the switches in case you need to quickly turn the machine **OFF**.

—When operating correctly, the machine runs smoothly with little or no vibration or rubbing noises.

—Investigate and correct strange or unusual noises or vibrations before operating the machine further. Always disconnect the machine from power before investigating or correcting potential problems.

5. Turn the downdraft table **OFF**.

6. Remove the safety keys (**Figure 12**) and attempt to turn the machine **ON**.

—If the machine starts, stop it. The switch disabling feature is not working. This safety feature must work properly before proceeding. Call Tech Support for help.

—If the machine does not start, the switch disabling feature is working.

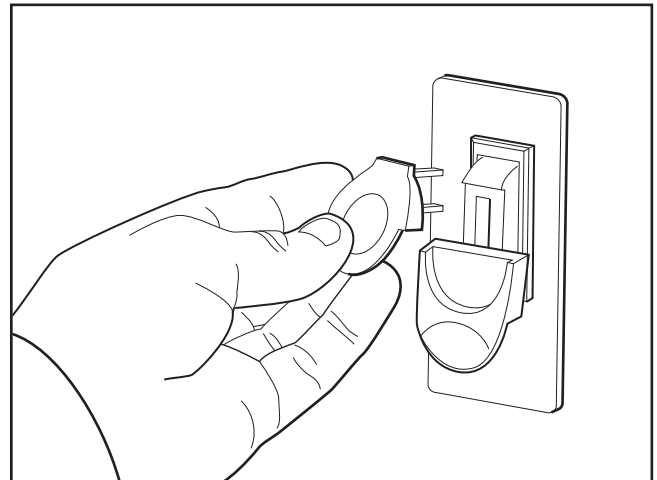

Figure 12. Disabling switch.

SECTION 4: OPERATIONS

Operation Safety

!WARNING

Damage to your eyes, lungs, and ears could result from using this machine without proper protective gear. Always wear safety glasses, a respirator, and hearing protection when operating this machine.

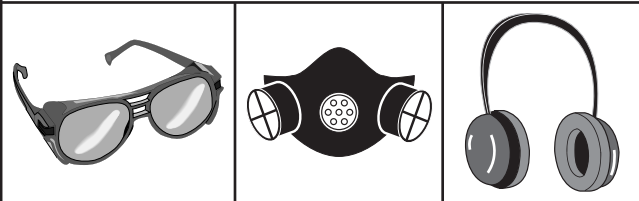

!WARNING

Loose hair and clothing could get caught in machinery and cause serious personal injury. Keep loose clothing and long hair away from moving machinery.

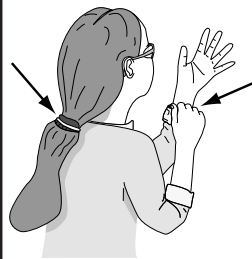

!WARNING

A fire/explosion could occur if this machine is used to collect paint fumes or overspray! Do not use downdraft table as a paint spray bench.



NOTICE

If you have never used this type of machine or equipment before, WE STRONGLY RECOMMEND that you read books, trade magazines, or get formal training before beginning any projects. Regardless of the content in this section, Grizzly Industrial will not be held liable for accidents caused by lack of training.

Dust Drawers

Frequently monitor and empty the dust drawers of accumulated sawdust (**Figure 13**).

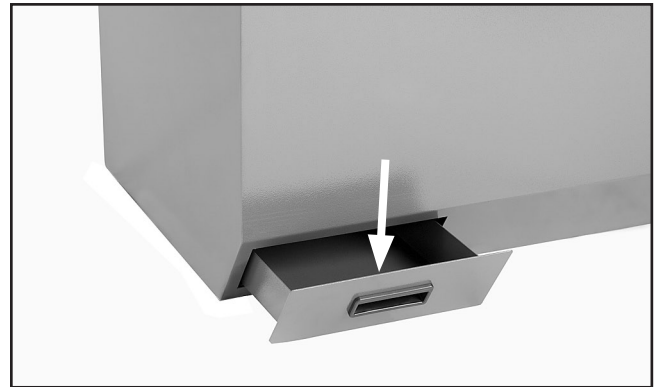

Figure 13. Dust drawer (one shown).

Operation

To use the Model G0631:

1. Place the panels in the upright position and latch them in place; or fold them down when sanding larger workpieces that extend beyond the table.
2. Place the workpiece on the rubber support grommets as you sand your workpiece as shown in **Figure 14**.



Figure 14. Typical sanding operation set up.

SECTION 5: ACCESSORIES

H4961—16" x 25" x 1" (1 Micron) Prefilter for G0631

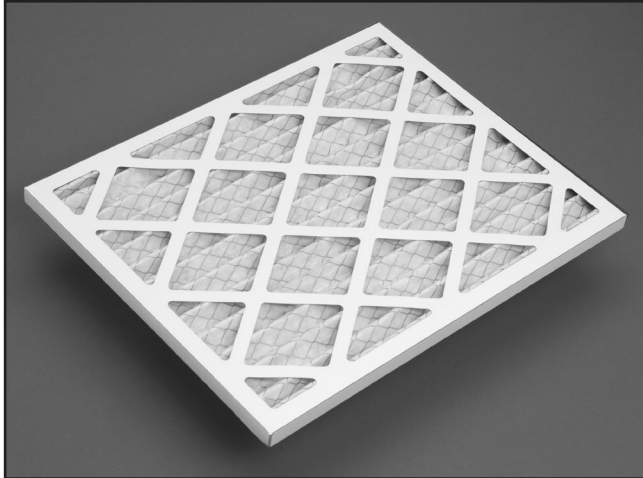

Figure 15. Model H4961.

H4938—16" x 25" x 2" (0.3 Micron) Filter for G0631

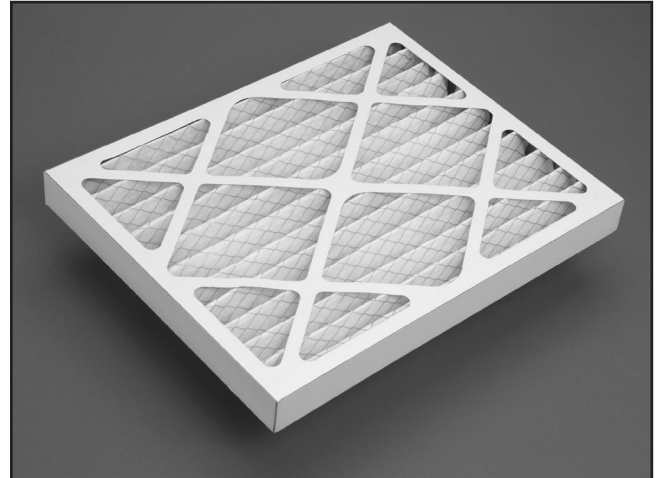

Figure 17. Model H4938.

H3120—Palm Detail Sander

This hook and loop orbital Palm Sander is just the tool for working tight corners and all-around finish sanding. Includes sander, dust bag, vacuum adapter, 3-pcs. 60 grit, 3-pcs. 120 grit, 4-pcs. 240 grit, steel wool pad, foam pad and scuff pad. Comes in a handy carry case.



Figure 16. Model H3120.

G5970—Electric Palm Sander

This quarter-sheet palm sander features a built-in dust collection bag and sealed On/Off switch for long dependable life. Swirl-free 10,000 orbits per minute make this double insulated sander an indispensable part of any shop.



Figure 18. Model G5970.

H5916—60 Grit 10 Pack Sandpaper for H3120

H5917—120 Grit 10 Pack for H3120

H5918—180 Grit 10 Pack for H3120

H5919—240 Grit 10 Pack for H3120

Call 1-800-523-4777 To Order

- G7984—Face Shield**
- H1298—Dust Sealed Safety Glasses**
- H1300—UV Blocking, Clear Safety Glasses**
- H2347—Uvex® Spitfire Safety Glasses**
- H0736—Shop Fox® Safety Glasses**

Safety Glasses are essential to every shop. If you already have a pair, buy extras for visitors or employees. You can't be too careful when it comes to shop safety!



Figure 19. Our most popular safety glasses.

- H2499—Small Half-Mask Respirator**
- H3631—Medium Half-Mask Respirator**
- H3632—Large Half-Mask Respirator**
- H3633—Disposable Cartridge Filter Pair**
- H3635—Disposable Cartridge Filter Pair**

This lightweight elastomeric facepiece has cradle suspension, easy adjust headstraps and low profile for greater field of vision and compatibility with normal use of glasses or goggles. Purchase cartridges separately depending upon intended application.

Model H3633 protects against organic vapor, sulfur dioxide, hydrogen chloride and chlorine. Model H3635 protects against all particulate aerosols.



Figure 20. Half-mask respirator and disposable cartridge filters.

SECTION 6: MAINTENANCE

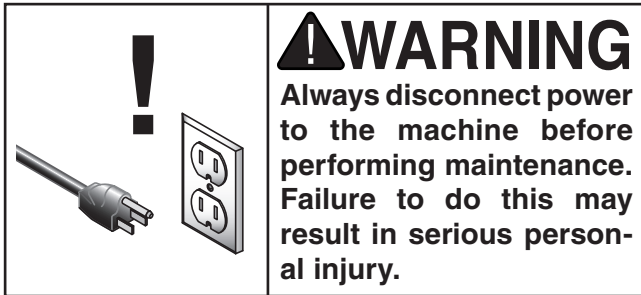

Schedule

For optimum performance from your machine, follow this maintenance schedule and refer to any specific instructions given in this section.

Daily Check:

- Check filters.
- Dust drawers.
- Loose mounting bolts.
- Worn or damaged wires.
- Any other unsafe condition.

Weekly Maintenance:

- Check filters.
- Dust drawers.

Monthly Check:

- Clean/vacuum dust buildup from inside cabinet and off motors.

Cleaning

Cleaning the Model G0631 is relatively easy. Vacuum excess sawdust, and wipe off the remaining dust with a dry cloth. If any resin has built up, use a resin dissolving cleaner to remove it.

Filters

The filters may need to be serviced or replaced if suction is noticeably reduced. The amount of use has a direct bearing on how often you must service or change the 1" prefilter and 2" filter.

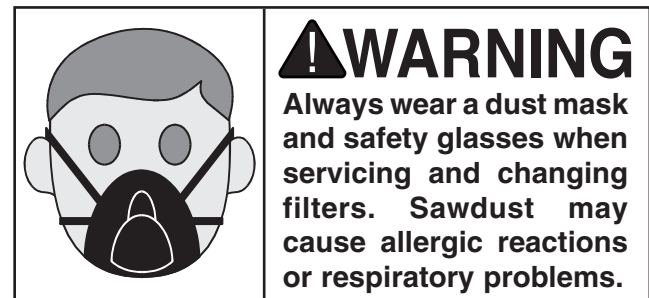

To service the filters:

1. DISCONNECT POWER TO THE DOWNDRAFT TABLE!
2. Remove the two outside downdraft plates, remove the filters, and gently knock the filters out inside a garbage can.

Note: Generally this technique will work two or three times, then you will have to replace the filter.

3. Reinstall the filters and the downdraft plates.

To change a filter:

1. DISCONNECT POWER TO THE DOWNDRAFT TABLE!
2. Remove the outside downdraft plates, remove the filters, install new filters, and reinstall the plates.



SECTION 7: SERVICE

Review the troubleshooting and procedures in this section to fix or adjust your machine if a problem develops. If you need replacement parts or you are unsure of your repair skills, then feel free to call our Technical Support at (570) 546-9663.

Troubleshooting

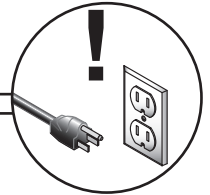

Motor & Electrical

Symptom	Possible Cause	Possible Solution
Machine does not start or a fuse/breaker trips.	<ol style="list-style-type: none">1. Fuse/breaker has blown.2. Switch disabling key is removed or at fault.3. Motor is at fault.4. Capacitor is at fault.	<ol style="list-style-type: none">1. Correct short/replace fuse/replace breaker.2. Install/replace switch disabling key; replace switch.3. Correct motor wiring connections or replace bad motor.4. Replace capacitor.
Machine has vibration or noisy operation.	<ol style="list-style-type: none">1. Fan is bent or loose.2. Motor or component is loose.	<ol style="list-style-type: none">1. Adjust fan balance or replace fan.2. Inspect/replace stripped or damaged bolts/nuts, and re-tighten with thread locking fluid.

Operations

Symptom	Possible Cause	Possible Solution
Downdraft table does not adequately collect dust; poor performance.	<ol style="list-style-type: none">1. Dust collection drawer is full.2. Filter is dirty.	<ol style="list-style-type: none">1. Empty collection drawer.2. Knock dust off filter. If this has no effect, replace with new filter unit.



Electrical Components

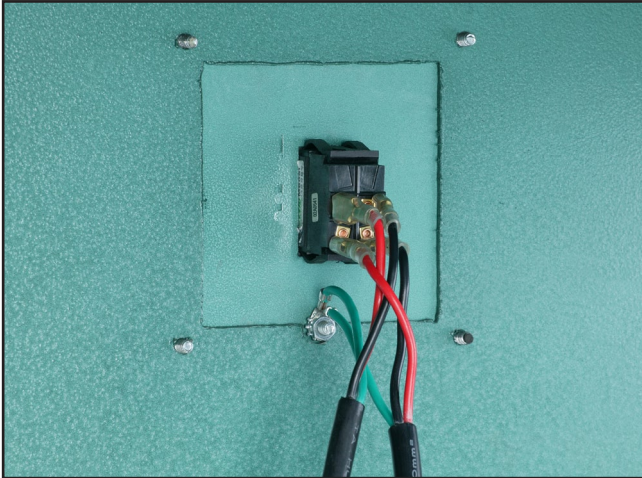

Figure 21. Right Switch wiring.

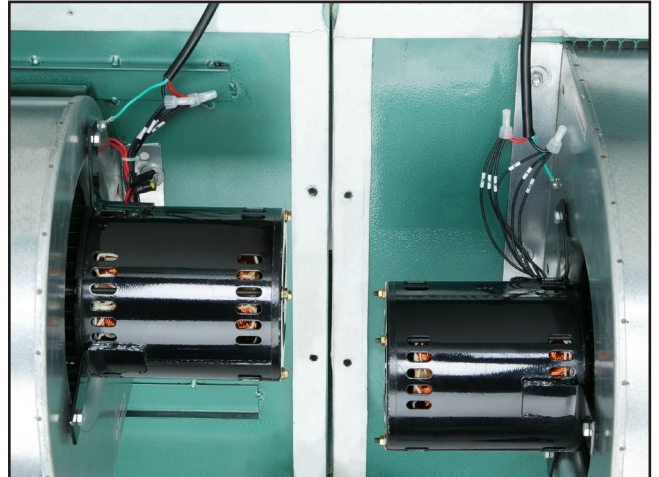

Figure 23. Wiring for both motors.

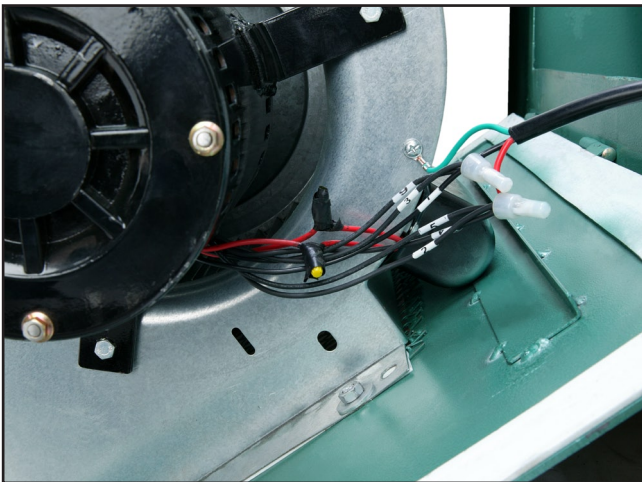

Figure 22. Left motor wiring.

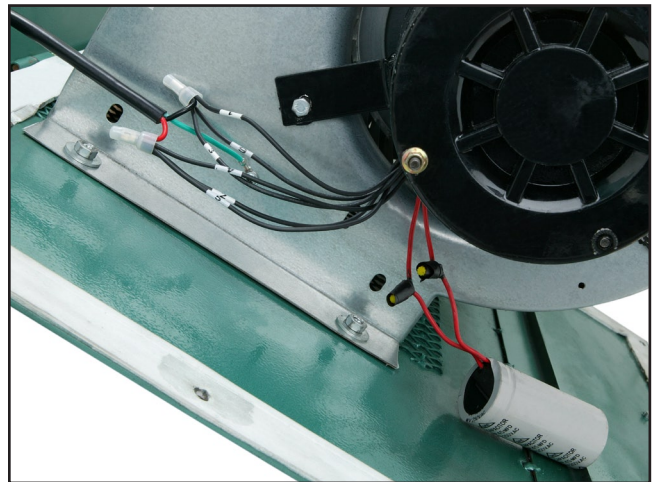

Figure 24. Right Motor Wiring.

Wiring Diagram



COLOR KEY	
BLACK	
GREEN	
RED	

⚠ DANGER
 Disconnect power before performing any electrical service. Electricity presents serious shock hazards that will result in severe personal injury and even death!



LEFT PADDLE SWITCH
 (viewed from behind)

RIGHT PADDLE SWITCH
 (viewed from behind)

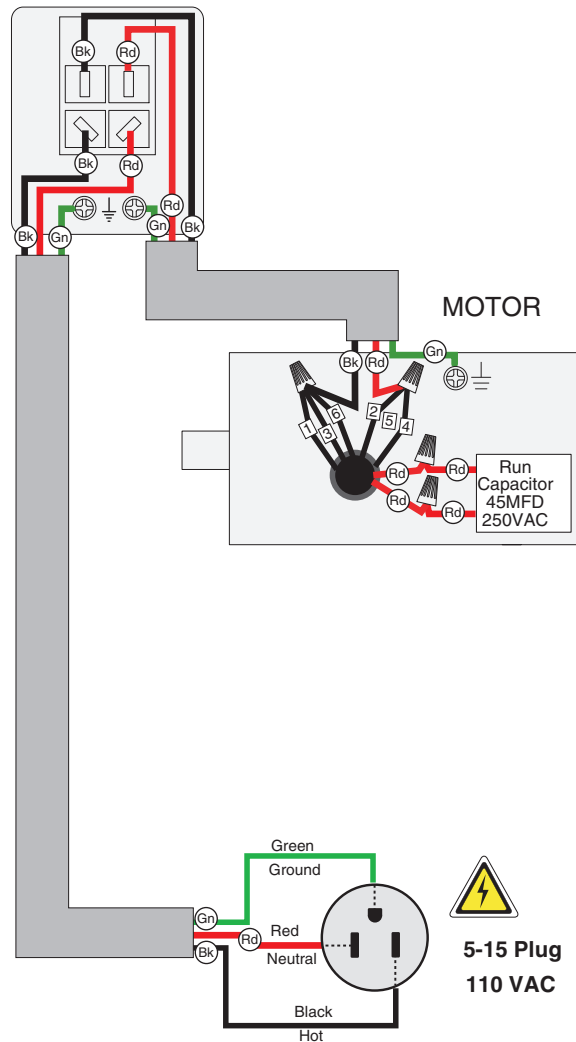
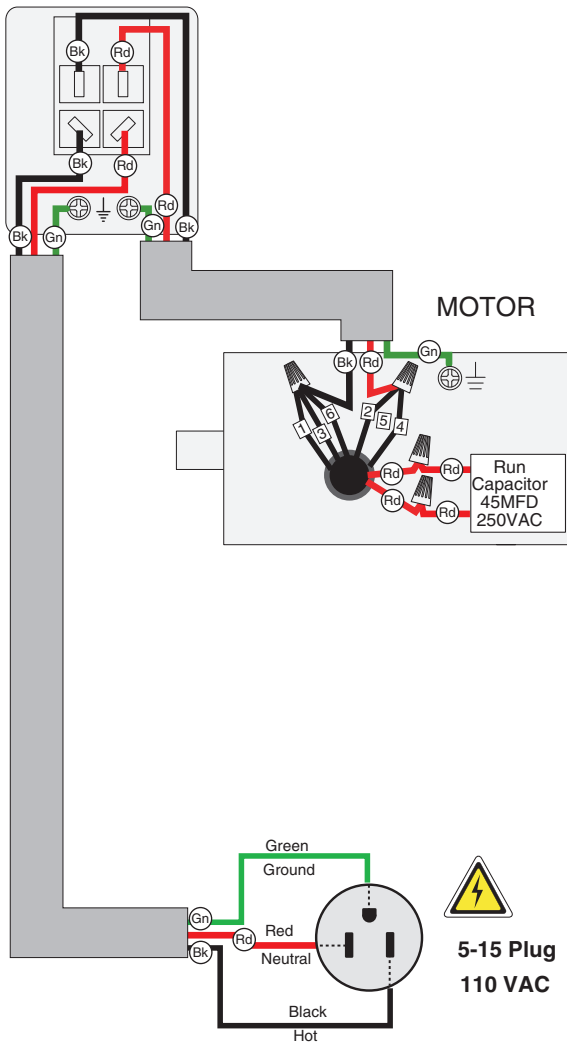

Parts Breakdown

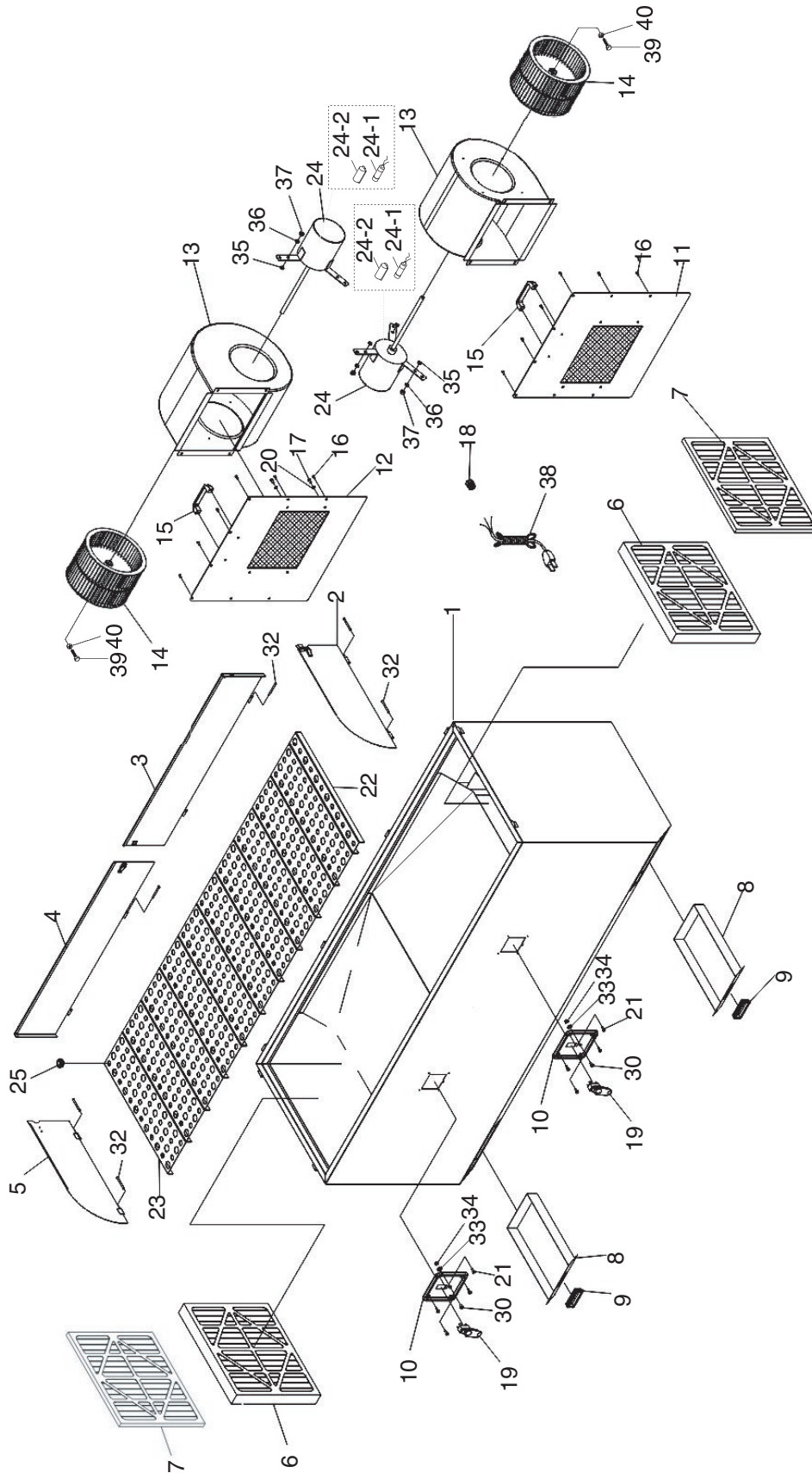

Parts List

REF	PART #	DESCRIPTION
1	P0631001	MAIN BASE
2	P0631002	RIGHT PANEL
3	P0631003	RIGHT CENTER PANEL
4	P0631004	LEFT CENTER PANEL
5	P0631005	LEFT PANEL
6	P0631006	FILTER 16" X 25" X 2" (0.3 MICRONS)
7	P0631007	FILTER 16" X 25" X 1" (1 MICRONS)
8	P0631008	DRAWER
9	P0631009	HANDLE
10	P0631010	SWITCH PLATE
11	P0631011	LEFT OUTLET PLATE
12	P0631012	RIGHT OUTLET PLATE
13	P0631013	FAN HOUSING
14	P0631014	IMPELLER
15	P0631015	HANDLE
16	PB19	HEX BOLT 1/4-20 X 1/2
17	PSB30	CAP SCREW 5/16-18 X 1/2
18	P0631018	STRAIN RELIEF
19	P0631019	PADDLE SWITCH

REF	PART #	DESCRIPTION
20	PW03	FLAT WASHER #10
21	PS06	PHLP HD SCR 10-24 X 3/8
22	P0631022	SMALL DUST COLLECTING PLATE
23	P0631023	BIG DUST COLLECTING PLATE
24	P0631024	MOTOR 110V, 1HP
24-1	P0631024-1	CAPACITOR 45MFD 250VAC
24-2	P0631024-2	CAPACITOR COVER
25	P0631025	RUBBER PAD
30	PS06	PHLP HD SCR 10-24 X 3/8
32	P0631032	PIN 6 X 66
33	PTLW01	EXT TOOTH WASHER #10
34	PN07	HEX NUT 10-24
35	P0631035	RUBBER PACKING 6.5 x 18 x 3
36	PW06	FLAT WASHER 1/4
37	PLN02	LOCK NUT 1/4-20
38	P0631038	POWER CORD
39	PB09M	HEX BOLT M8-1.25 X 20
40	PN03M	HEX NUT M8-1.25



Safety Label Placement and Parts List

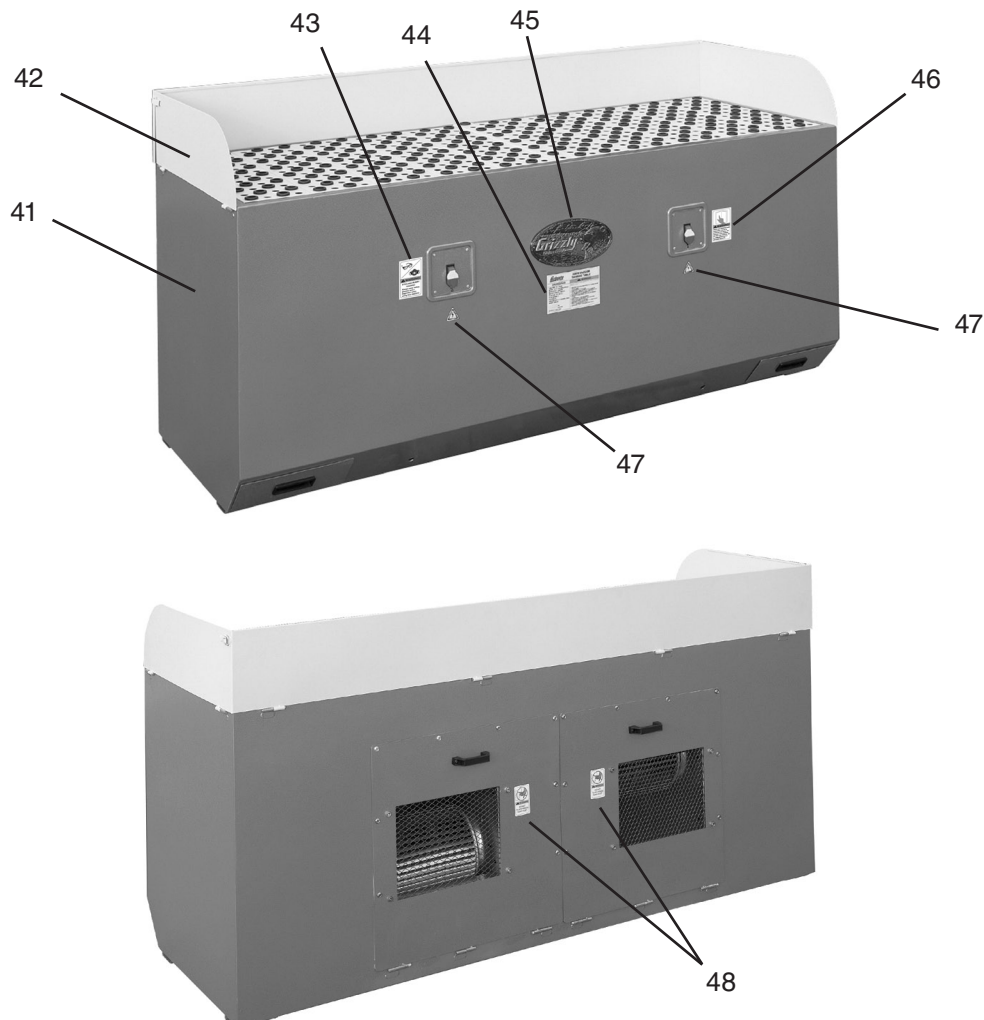

REF	PART #	DESCRIPTION
41	PPAINT-1	PAINT-GRIZZLY GREEN
42	PPAINT-11	PUTTY TOUCH UP PAINT
43	P0631043	EYE-LUNG INJURY LABEL
44	P0631044	G0631 MACHINE ID LABEL
45	G8589	GRIZZLY NAMEPLATE-LARGE
46	PLABEL-12A	READ MANUAL LABEL
47	PLABEL-14	ELECTRICITY LABEL
48	P0631048	NO HANDS IN OUTLET LABEL

WARNING

Safety labels warn about machine hazards and ways to prevent injury. The owner of this machine **MUST** maintain the original location and readability of the labels on the machine. If any label is removed or becomes unreadable, **REPLACE** that label before using the machine again. Contact Grizzly at (800) 523-4777 or www.grizzly.com to order new labels.

WARRANTY AND RETURNS

Grizzly Industrial, Inc. warrants every product it sells for a period of **1 year** to the original purchaser from the date of purchase. This warranty does not apply to defects due directly or indirectly to misuse, abuse, negligence, accidents, repairs or alterations or lack of maintenance. This is Grizzly's sole written warranty and any and all warranties that may be implied by law, including any merchantability or fitness, for any particular purpose, are hereby limited to the duration of this written warranty. We do not warrant or represent that the merchandise complies with the provisions of any law or acts unless the manufacturer so warrants. In no event shall Grizzly's liability under this warranty exceed the purchase price paid for the product and any legal actions brought against Grizzly shall be tried in the State of Washington, County of Whatcom.

We shall in no event be liable for death, injuries to persons or property or for incidental, contingent, special, or consequential damages arising from the use of our products.

To take advantage of this warranty, contact us by mail or phone and give us all the details. We will then issue you a "Return Number," which must be clearly posted on the outside as well as the inside of the carton. We will not accept any item back without this number. Proof of purchase must accompany the merchandise.

The manufacturers reserve the right to change specifications at any time because they constantly strive to achieve better quality equipment. We make every effort to ensure that our products meet high quality and durability standards and we hope you never need to use this warranty.

Please feel free to write or call us if you have any questions about the machine or the manual.

Thank you again for your business and continued support. We hope to serve you again soon.





WARRANTY CARD

Name _____
 Street _____
 City _____ State _____ Zip _____
 Phone # _____ Email _____ Invoice # _____
 Model # _____ Order # _____ Serial # _____

The following information is given on a voluntary basis. It will be used for marketing purposes to help us develop better products and services. **Of course, all information is strictly confidential.**

1. How did you learn about us?

Advertisement Friend Catalog
 Card Deck Website Other:

2. Which of the following magazines do you subscribe to?

<input type="checkbox"/> Cabinet Maker	<input type="checkbox"/> Popular Mechanics	<input type="checkbox"/> Today's Homeowner
<input type="checkbox"/> Family Handyman	<input type="checkbox"/> Popular Science	<input type="checkbox"/> Wood
<input type="checkbox"/> Hand Loader	<input type="checkbox"/> Popular Woodworking	<input type="checkbox"/> Wooden Boat
<input type="checkbox"/> Handy	<input type="checkbox"/> Practical Homeowner	<input type="checkbox"/> Woodshop News
<input type="checkbox"/> Home Shop Machinist	<input type="checkbox"/> Precision Shooter	<input type="checkbox"/> Woodsmith
<input type="checkbox"/> Journal of Light Cont.	<input type="checkbox"/> Projects in Metal	<input type="checkbox"/> Woodwork
<input type="checkbox"/> Live Steam	<input type="checkbox"/> RC Modeler	<input type="checkbox"/> Woodworker West
<input type="checkbox"/> Model Airplane News	<input type="checkbox"/> Rifle	<input type="checkbox"/> Woodworker's Journal
<input type="checkbox"/> Modeltec	<input type="checkbox"/> Shop Notes	<input type="checkbox"/> Other:
<input type="checkbox"/> Old House Journal	<input type="checkbox"/> Shotgun News	

3. What is your annual household income?

\$20,000-\$29,000 \$30,000-\$39,000 \$40,000-\$49,000
 \$50,000-\$59,000 \$60,000-\$69,000 \$70,000+

4. What is your age group?

20-29 30-39 40-49
 50-59 60-69 70+

5. How long have you been a woodworker/metalworker?

0-2 Years 2-8 Years 8-20 Years 20+ Years

6. How many of your machines or tools are Grizzly?

0-2 3-5 6-9 10+

7. Do you think your machine represents a good value? Yes No

8. Would you recommend Grizzly Industrial to a friend? Yes No

9. Would you allow us to use your name as a reference for Grizzly customers in your area?
Note: We never use names more than 3 times. Yes No

10. Comments: _____

CUT ALONG DOTTED LINE

FOLD ALONG DOTTED LINE



Place
Stamp
Here



GRIZZLY INDUSTRIAL, INC.
P.O. BOX 2069
BELLINGHAM, WA 98227-2069



FOLD ALONG DOTTED LINE

Send a Grizzly Catalog to a friend:

Name _____
Street _____
City _____ State _____ Zip _____

TAPE ALONG EDGES--PLEASE DO NOT STAPLE

grizzly.com

TOOL WEBSITE

Buy Direct and Save with Grizzly® – Trusted, Proven and a Great Value!

*Visit Our Website Today And Discover
Why Grizzly® Is The Industry Leader!*

- SECURE ORDERING
- ORDERS SHIPPED WITHIN 24 HOURS
- E-MAIL RESPONSE WITHIN ONE HOUR

-OR-

Call Today For A **FREE**
Full Color Catalog

1-800-523-4777



Free Manuals Download Website

<http://myh66.com>

<http://usermanuals.us>

<http://www.somanuals.com>

<http://www.4manuals.cc>

<http://www.manual-lib.com>

<http://www.404manual.com>

<http://www.luxmanual.com>

<http://aubethermostatmanual.com>

Golf course search by state

<http://golfingnear.com>

Email search by domain

<http://emailbydomain.com>

Auto manuals search

<http://auto.somanuals.com>

TV manuals search

<http://tv.somanuals.com>