

Model G4672 Magnetic Switch Instruction Sheet

COLOR KEY	
BLACK	
GREEN	
RED	
YELLOW	
WHITE	

View this page in color at www.grizzly.com.

⚠ WARNING
Electrocution or fire could occur if this switch is not installed by a qualified electrician!

220 Volt
3-Phase
Power Source



MAGNETIC SWITCH ASSEMBLY

← Contactor
TECO
CN-16
(220V Coil) →

← Thermal Overload Relay
TECO
RHN-10K
(5.5-8.5A) →

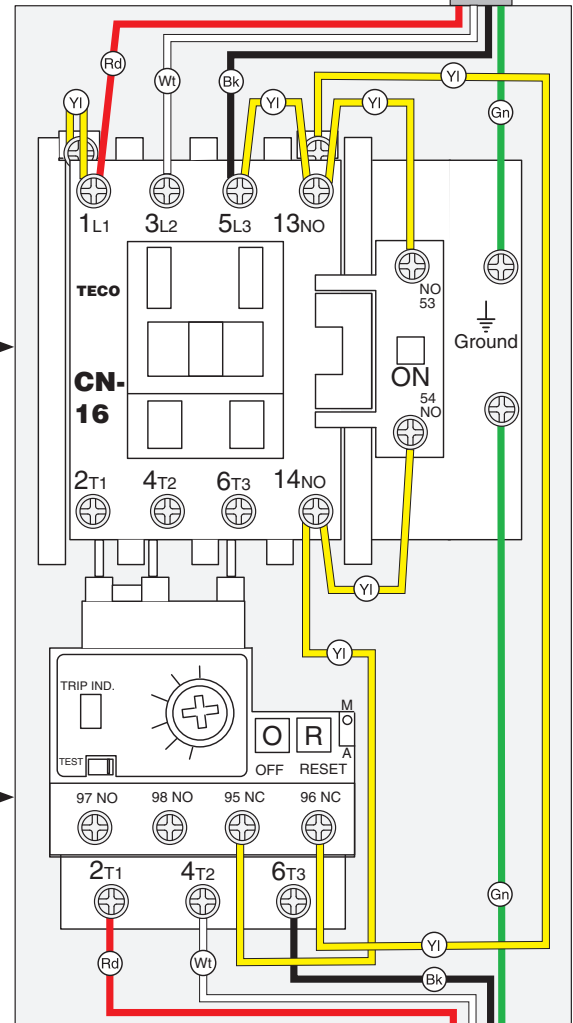

2 HP 3-Phase
220V Motor

IMPORTANT: This magnetic switch toggles a motor ON and OFF, and helps provide thermal overload protection for the motor if operating temperature gradually increases due to heavy work loads. The thermal overload relay inside is not designed to cut power in the event of a sudden motor overload or stall. To help protect a motor from this type of overload, this magnetic switch **MUST** be connected to a properly sized power supply circuit with a correct fuse or circuit breaker.

OPERATION: The green push button switch allows current to go to the magnetic coil which pulls the contactor closed. Main current now passes through the thermal overload relay and then to the motor. This relay monitors motor current draw. If the motor begins to overheat, this relay breaks the magnetic field, which opens the contactor and cuts current to the motor. The red push button breaks the magnetic field, which opens the contactor and disconnects the current to the motor.



Thermal Relay Overload Amp Adjustment Dial:

Turn this dial to meet your motor manufacturer's thermal overload amp setting specification. Typically this setting is 100-110% of what is listed on the motor data plate as the max amp load. Remember, turning this dial has no effect on increasing motor horsepower. If this dial is turned to an amp setting that is too high, the motor can overheat and be damaged before the relay trips.

Trip Indicator: If the window is flagged yellow, the thermal relay has tripped.

Manual Trip Test Lever: If the thermal relay function is in question, use a wooden toothpick to slide the yellow test lever to the left. If the motor shuts off, the thermal relay has tripped and is functional.

OFF Button:

When pushed, the current going to the magnetic field coil is cut, which opens the contactor and cuts power to the motor.

Manual Contactor Override Lug: When pushed, the contactor is manually closed for troubleshooting purposes only.

ON Button:

When pushed, power is sent to the magnetic field coil and the contactor closes and sends power to the motor.

Manual/Auto Reset Lever:

In the up position, the thermal relay is in manual reset mode, where if tripped, you must first push the red and then the green ON button reset button on the outside of the main cover to reset the thermal relay. In the down position, the thermal relay will automatically reset when it has cooled.

Reset Button:

When pushed, the thermal relay is reset and the yellow flag shown in the trip indicator window is cleared.

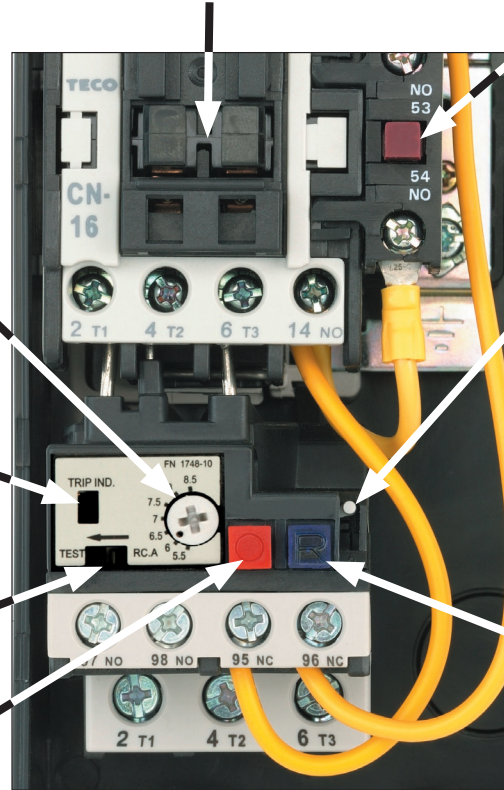

Parts Breakdown

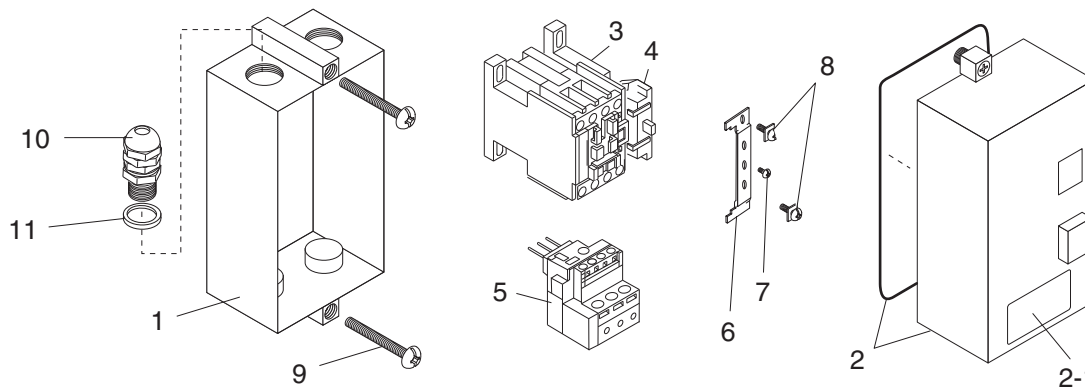

REF	PART #	DESCRIPTION
1	P4571001	SWITCH BOX
2	P4571002	SWITCH BOX COVER ASSEMBLY
2-1	P4672002-1	DATA LABEL, HNFB-16KK
3	P4571003	CONTACTOR TECO CN-16 230V
4	P4571004	FIELD SWITCH TECO CNA-1
5	P4672005	RELAY TECO RHN-10K 5.5-8.5A

REF	PART #	DESCRIPTION
6	P4571006	CONTACTOR RETAINER
7	PS55M	PHLP HD SCR M3-.5 X 10
8	P4571008	CAPTURED GROUND SCR M4-.7 X 10
9	PS10	PHLP HD SCR 10-24 X 1-1/2
10	P4571010	LIQUID-TITE STRAIN RELIEF
11	P4571011	RUBBER SEAL

COPYRIGHT © JANUARY, 2008 BY GRIZZLY INDUSTRIAL, INC. WARNING: NO PORTION OF THIS MANUAL MAY BE REPRODUCED IN ANY SHAPE OR FORM WITHOUT THE WRITTEN APPROVAL OF GRIZZLY INDUSTRIAL, INC.
#CR10358 PRINTED IN TAIWAN



Free Manuals Download Website

<http://myh66.com>

<http://usermanuals.us>

<http://www.somanuals.com>

<http://www.4manuals.cc>

<http://www.manual-lib.com>

<http://www.404manual.com>

<http://www.luxmanual.com>

<http://aubethermostatmanual.com>

Golf course search by state

<http://golfingnear.com>

Email search by domain

<http://emailbydomain.com>

Auto manuals search

<http://auto.somanuals.com>

TV manuals search

<http://tv.somanuals.com>