

Grizzly

Industrial, Inc.®

MODEL T10006

50 Kg DIGITAL CRANE SCALE

OWNER'S MANUAL



COPYRIGHT © OCTOBER, 2007 BY GRIZZLY INDUSTRIAL, INC.
WARNING: NO PORTION OF THIS MANUAL MAY BE REPRODUCED IN ANY SHAPE OR FORM WITHOUT THE WRITTEN APPROVAL OF GRIZZLY INDUSTRIAL, INC.
#JM9992 PRINTED IN CHINA

SECTION 1: SAFETY

WARNING!

This manual provides critical safety instructions on the proper setup, operation, maintenance and service of this machine/equipment.

Failure to read, understand and follow the instructions given in this manual may result in serious personal injury, including amputation, electrocution or death.

The owner of this machine/equipment is solely responsible for its safe use. This responsibility includes but is not limited to proper installation in a safe environment, personnel training and usage authorization, proper inspection and maintenance, manual availability and comprehension, application of safety devices, blade/cutter integrity, and the usage of personal protective equipment.

The manufacturer will not be held liable for injury or property damage from negligence, improper training, machine modifications or misuse.

WARNING

For Your Own Safety Read Instruction Manual Before Operating This Equipment

The purpose of safety symbols is to attract your attention to possible hazardous conditions. This manual uses a series of symbols and signal words which are intended to convey the level of importance of the safety messages. The progression of symbols is described below. Remember that safety messages by themselves do not eliminate danger and are not a substitute for proper accident prevention measures.

DANGER

Indicates an imminently hazardous situation which, if not avoided, WILL result in death or serious injury.

WARNING

Indicates a potentially hazardous situation which, if not avoided, COULD result in death or serious injury.

CAUTION

Indicates a potentially hazardous situation which, if not avoided, MAY result in minor or moderate injury. It may also be used to alert against unsafe practices.

NOTICE

This symbol is used to alert the user to useful information about proper operation of the equipment.

WARNING

Safety Instructions for Crane Scales

1. **READ THROUGH THE ENTIRE MANUAL BEFORE USING.** This crane scale presents serious injury hazards to untrained users.
2. **NEVER ALLOW UNQUALIFIED PERSONNEL TO SERVICE THIS SCALE.** Servicing the scale incorrectly may reduce the maximum holding capacity of the load cell or cause the scale to give incorrect readings, which may result in overloading.
3. **DO NOT LIFT MORE THAN THE MAXIMUM SUGGESTED CAPACITY.** Be aware that the load weight, harnesses and load bearing equipment all contribute to the total load weight. Overloading may cause the load to fall.
4. **NEVER LIFT HEAVY LOADS WHEN TIRED, OR UNDER THE INFLUENCE OF DRUGS OR ALCOHOL.** Be mentally alert at all times when lifting or moving heavy loads.
5. **ONLY ALLOW TRAINED AND PROPERLY SUPERVISED PERSONNEL TO OPERATE SCALE.** Make sure operation instructions are safe and clearly understood.
6. **NEVER LEAVE A LOAD WHILE SUSPENDED.** Lower the load to the ground and un-hook all loads and harnesses before leaving the crane scale unattended.
7. **NEVER SUSPEND THE LOAD OVER OR NEAR A PERSON.** Loads may fall at any given time due to overloading, improper loading procedures, or failure of a component.
8. **ALWAYS DISCONNECT FROM POWER SOURCE BEFORE SERVICING.** Make sure switch is in OFF position, charger is unplugged, and battery disconnected before servicing.
9. **CHECK FOR DAMAGED PARTS BEFORE USING SCALE.** Check for broken parts, loose bolts, cracked or worn components and any other conditions that may affect machine operation. Repair or replace damaged parts.
10. **USE RECOMMENDED ACCESSORIES.** Refer to the instruction manual for recommended accessories. The use of improper accessories may increase risk of injury.
11. **NEVER LET LOADS SWING.** Unsteady loads may become unbalanced and fall. Swinging motions cause wear on components and may cause them to break.
12. **USE CORRECT HARNESES.** Never use oversized or multiple harnesses.
13. **CHARGE ONLY USING THE SUPPLIED CHARGER AND BATTERY.** Do not use with other batteries, chargers or scales.
14. **DO NOT EXPOSE BATTERY OR CHARGER TO WET OR RAINY CONDITIONS.** Moisture greatly increases the risk of a shock hazard.
15. **DO NOT STORE BATTERY WITH CONDUCTIVE MATERIALS.** Storing the battery in a box of screws or nails can cause shorting across the battery poles.

SECTION 2: INTRODUCTION

Foreword

It is our pleasure to provide this manual with the Model T10006. It was written to encourage safety considerations and guide you through general operating procedures and maintenance.

The specifications, details, and photographs in this manual represent the Model T10006 as supplied when the manual was prepared. However, owing to Grizzly's policy of continuous improvement, changes may be made at any time with no obligation on the part of Grizzly.

Machine Data

Maximum Capacity.....50 Kg (110 lbs.)
Minimum Load.....0.4 Kg (0.88 lbs.)
Crane Battery.....Rechargeable 6V/5Ah
Crane Battery Life.....50+ hrs.
Crane Battery Adapter.....DC9V/1500mA
Operating Temperature.....-10°C – 40°C/
14°F – 104°F
Operating Humidity.....85% or Less
Remote Control Battery.....#5, 1.5Vx2
Digital Display.....5 Digit LCD/LED
Character Display.....30mm High
Scale Body.....Die-Cast Aluminum Case
Scale Weight 10.35 lbs.

Contact Info

If you have any comments regarding this manual, please contact us:

Grizzly Industrial, Inc.
C/O Technical Documentation Manager
P.O. Box 2069
Bellingham, WA 98227-2069
Email: manuals@grizzly.com

Most importantly, we stand behind our tools. If you have any service questions or parts requests, please call or write us at the location listed below.

Grizzly Industrial, Inc.
1203 Lycoming Mall Circle
Muncy, PA 17756
Phone: (570) 546-9663
Fax: (800) 438-5901
E-Mail: techsupport@grizzly.com
Web Site: <http://www.grizzly.com>

⚠ WARNING

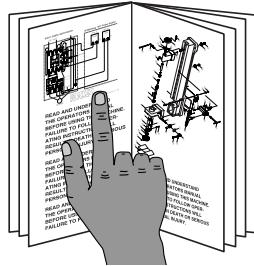

Read the manual before operation. Become familiar with this scale, its safety instructions, and its operation before beginning any work. Serious personal injury may result if safety or operational information is not understood or followed.

SECTION 3: SETUP

Unpacking

Your crane scale was carefully packaged for safe shipping. If you discover any damage after you have signed for delivery, *immediately call Customer Service at (570) 546-9663 for advice.*

Save the containers and all packing materials for possible inspection by the carrier or its agent. *Otherwise, filing a freight claim can be difficult.*

When you are completely satisfied with the condition of the shipment, you should inventory the contents.

Inventory

Model T10006 Inventory (Figure 1)

- A. Crane Scale 1
- B. Remote Control 1
- C. Scale Battery Charger 1

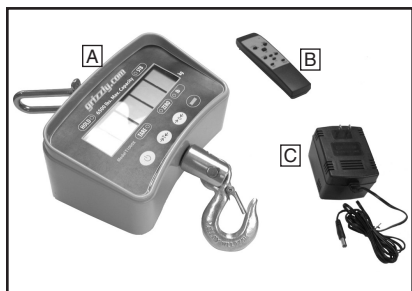

Figure 1. Model T10006 inventory

Site Consideration

Weight Capacity

The Model T10006 crane scale has a maximum capacity of 50 Kg (110 lbs.). When choosing a mounting site, verify that the hardware and the site can withstand at least the maximum loading capacity as well as any possible overloading that may occur.

Working Clearances

Consider existing and anticipated needs, dimensions of your weighing platform, size of material to be processed, and whether you need the scale to be mobile or in a stationary location when establishing an installation site for your crane scale. For an accurate reading, there must not be any items near the scale or weighing platform that may lean or fall and add weight.

Power Outlets

The Model T10006 crane scale includes a remote control and scale battery charger. When establishing a site for your scale, make sure outlets are located near the scale so power or extension cords are clear of high-traffic areas.

Do not place crane scale in areas of high electrical fields. Electrical fields can prevent scale accuracy.

⚠ CAUTION

No list of safety guidelines is complete, because every work environment is different. Always consider safety first and use common sense. Failure to use this tool with caution and respect could result in serious personal injury.

Loading Hardware

When attaching your crane scale:

1. DO NOT use multiple chains or harnesses. Only one point of contact should be used on the hook and shackle to lessen the chance of the load falling and to allow proper load alignment.
2. DO NOT use oversized items or harnesses. Oversized items creates multiple points of contact and will not fit properly with the crane scale hardware. Inaccurate readings, uneven, and dangerous loads may result.

Refer to **Figures 2 & 3** for Model T10006 dimensions.

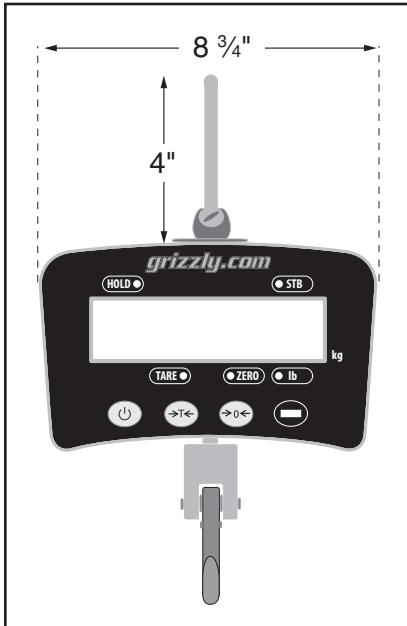

Figure 2. Scale front view measurements.

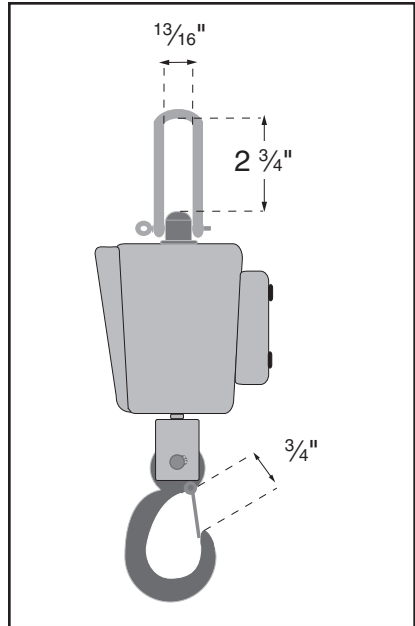

Figure 3. Scale side view measurements.

⚠ WARNING

Like all tools there is potential danger when operating this tool. Accidents are frequently caused by lack of familiarity or failure to pay attention. If normal safety precautions are overlooked or ignored, serious personal injury may occur.

NOTICE

To maintain accuracy, the scale should remain hanging and not be allowed to rest on the ground for a significant amount of time.

SECTION 4: OPERATIONS

Scale Functions

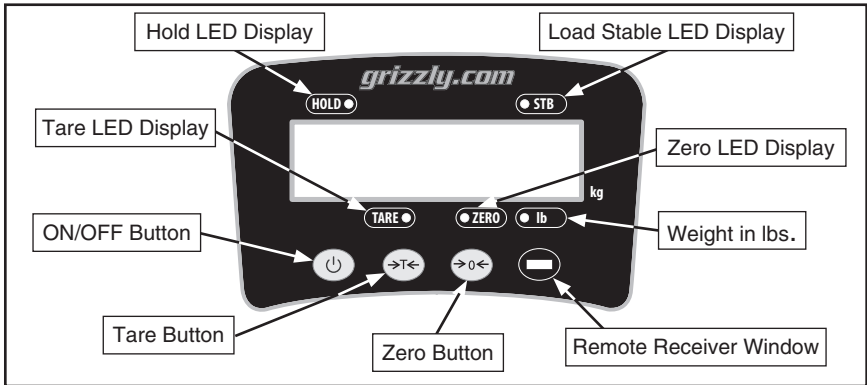



Figure 4. Scale face.



Turning the Scale ON

After your crane scale has been properly mounted, familiarize yourself with the functions both on the scale and on the remote control. Begin by holding down the  button on the scale to turn it **ON** (Figure 4). Each time the scale is turned on, it will flash a series of displays. Use the table below to familiarize yourself with the display and its meanings.

Function	Display	Action
Off/On	8.8.8.8.8	Start up, display twice
	110.25	Maximum capacity, display twice
	U X.XX	Current battery voltage
	----	Wait signal
	0.00	STB light will engage, ready

To guarantee accuracy for your crane scale, allow it warm up without a load for 3-5 minutes.

Zero Function

Generally, your scale will read the weight of the hook. To return your scale to zero, press the  button on the scale (Figure 4), or on the  0  button on the remote control.

Tare Function

The tare function will allow you to automatically deduct the weight of the weighing platforms or containers, resulting in a final weight of only the items that you want weighed (the net weight). When your scale is ready, attach your weighing platform to the lifting hook at the bottom of the scale, then wait until the "STB" light comes on. Before placing any items on the platform, deduct the weight of the platform by pressing the  button on the scale (Figure 4), or by pressing Tare on the remote control. After you have selected the Tare function for the platform, the scale will return to 0.00 between loads until you turn off the scale.

Power Saving

If the load is left at stable status, ("STB" as shown in Figure 4) for longer than 15 minutes, the screen will flash "—" to save power and will return to normal weighing readings when the load is changed. If the load is left at stable status for over 60 minutes, the scale will turn **OFF** automatically.

Overload Warning

If the load exceeds the maximum capacity (net + tare weight), -OL- will be displayed on the screen. DO NOT overload the scale. Failure to stay below the maximum load rating may result in injury, damage the scale, and void your warranty.

Turning the Scale OFF

To turn the scale **OFF**, hold down the  button on the scale or hold down the OFF button on the remote control.

Note: The scale will not turn off unless it is at the main weighing screen.

NOTICE

Do not use this scale during lightning and rain storms or other inclement weather. Turn the scale off, unplug any charging equipment and remove the battery.

NOTICE

If this scale is used for the selling of goods, it must be "Legal for Trade" and calibrated regularly.

Remote Control Functions

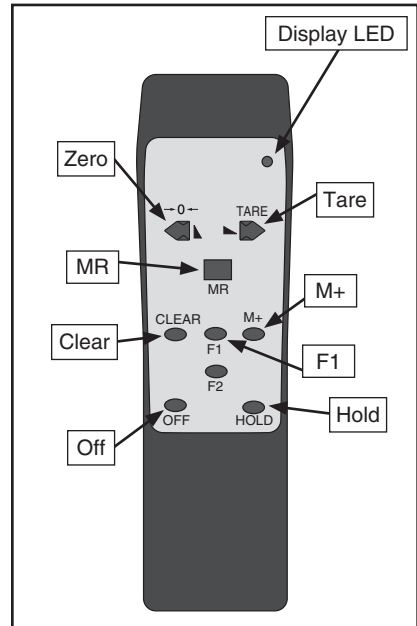

Figure 5. Remote control buttons.

Lb/Kg Conversion

The crane scale can display either in pounds or kilograms. To change between the measures of weight, press MR button on the remote and the screen will display SHIFT. Press HOLD and the screen will display UN=0 if converting to kilograms, or UN=1 if converting to pounds. If the current weight is in pounds, the "lb" light on the scale will light up. If the current weight is in kilograms then the "lb" light will be off.

Scale Battery

The scale will automatically display the current scale battery voltage when you turn the scale **ON** and **OFF**. To check the voltage during use, press the MR button on the remote control and the screen will display SHIFT. Press the F1 button and the screen will display U X.XX. To return to the main display, press MR again.

When the battery voltage is lower than U 5.80, the screen will flash to alert you. The scale will continue to display for approximately one minute longer until -Lb- is displayed on the screen, and then turn **OFF** automatically. The scale will need to be charged before further use.

To recharge the battery:

1. Turn the scale **OFF**.
2. Connect the supplied adapter into the socket located in the back of the scale, then into a grounded 110V outlet. The light turns orange while charging and turns red when charging is complete.

Note: *The battery should re-charge for at least 8 hours.*

Hold Function

When the load has been added to the scale, wait until the STB light goes off signifying that the load is stable (**Figure 4**). If you would like the weight value to remain on the screen, press the HOLD button on the remote control. To clear the screen, press the HOLD button again.

Current Zero Value:

The current zero value is the tare weight that was selected. To view the current zero scale value, press the MR button and the screen will display SHIFT. Press the $\rightarrow 0 \leftarrow$ button on the remote control to display the current zero value.

Advance Tare Weight

To input a known tare weight before weighing an item, press MR and the screen will display SHIFT. Press TARE, and the screen will display 000.00. To input the desired weight, scroll to the right by pressing the right arrow (TARE) on the remote control until you come to the number that you would like to change. To increase the number from zero, press the left button ($\rightarrow 0 \leftarrow$) on the remote control. To decrease the number, press CLEAR on the remote control. When you are satisfied with the current number, press the M+ to move to the left. To submit the tare amount, press MR and the TARE light will come on the scale, automatically deducting the imputed tare weight. The tare weight will stay the same until the scale is turned **OFF**.

Clear Function

To clear, press the CLEAR button and the screen will flash CLr. If you would like to approve the clear command, press MR and the screen will display 888.88, confirming the deletion. If you would like to cancel the clear command, press the CLEAR button again. The screen will display noCLr canceling the deletion.

Search Overload Times

To review how many instances the scale has been overloaded, press the MR button and the screen will display SHIFT. Press the CLEAR button and the screen will display OL=XX, showing how many times the scale has exceeded its maximum capacity.

Display Function

To change the brightness of the display, press F1. Display brightness ranges from 1 (minimum light) to 5 (maximum light). The default display setting is 2.

Note: The remote control is a generic remote and may contain buttons that will not be used with this particular model. Should you lose the included remote control, these functions can not be completed. To obtain a replacement controller from Grizzly; call 1-800-523-4777.

Reference Guide

For quick references and questions about scale displays, use the charts below for assistance.

Display	Action
----	Wait signal
Err10	Accumulated weight below capacity
Err11	Accumulated times exceed (30+)
Err12	Accumulated weight exceed (999.99)
CLr	Delete weight?
noCLr	Cancel deletion
88888	Confirm deletion
noACC	No accumulated value
SHIFt	Weight conversion
UX.XX	Current battery voltage
SCALE	Enter weight adjustment
SETUP	Enter parameter adjustment
UAdJ	Enter voltage adjustment
-OL-	Overload warning
-Lb-	Low battery warning
End	Parameter adjustment ready
OFF	Turn off

Function	Button	Display	Action
ON		8.8.8.8.8	
		110.25	
		U X.XX	

		0	Scale is ready for use

OFF	OFF/	U X.XX	
		OFF	Scale is OFF

Zero		0.00	Display reads 0, "Zero" LED is on
------	--	------	-----------------------------------

Tare	TARE/	0.00	Display reads 0, Tare LED is on
------	-------	------	---------------------------------

Hold	HOLD	XXX.XX	Weight is held, press HOLD to exit
------	------	--------	------------------------------------

Brightness	F1	1 through 5	1=lowest, 5=highest setting
------------	----	-------------	-----------------------------

Function	Button	Display	Button	Action
Lb/Kg Conversion	MR	SHIFT	HOLD	UN=0 (weight in Kg, "lb" LED is off)
				UN=1 (weight in lb, "lb" LED is on)

Battery Voltage	MR	SHIFT	F1	U X.XX, press MR to exit
-----------------	----	-------	----	--------------------------

Current Zero Value	MR	SHIFT	0	XXX.XX Current zero value
--------------------	----	-------	---	---------------------------

Advance Tare	MR	SHIFT	TARE/	TARE to scroll right
			0	→ 0 ← to increase number
			CLEAR	CLEAR to decrease number
			M+	M+ to submit and scroll left
			MR	MR to submit total, "TARE" LED is on

Overload Review	MR	SHIFT	CLEAR	OL=XX (Overload= XX times)
-----------------	----	-------	-------	----------------------------

Clear	CLEAR	CLR	MR	888.88 = confirmation of clear
			CLEAR	noCLR = cancel clear

SECTION 5: MAINTENANCE

General

Regularly check mounting hardware for cracks, unsafe wear, deformation, or warping. DO NOT attempt to fix these items! Discard and replace all damaged hardware. Regularly check for loose pins, rings, screws, and safety latches. Tighten or replace any loose items. Damaged or loose parts may cause the load to fall and may result in serious injury.

Always keep the scale in a hanging position to relieve strain on the load cell. Never leave a load or weighing equipment on the scale when not in use. This may cause excessive strain on the precision weighing device and may result in inaccurate readings and shorten the life of your scale.

When re-charging the scale battery, charge for at least 8 hours. Excessive charging will not damage the battery. Batteries must be recycled or disposed of properly.

If your scale malfunctions permanently, do not attempt to fix it yourself. Contact a certified professional for any electrical or detailed calibration work.

If the scale becomes dirty, clean the screen with a soft cloth using a mild window cleaner or detergent. Avoid using paper towels. DO NOT use solvents, chemicals or other corrosive materials to clean the scale.

If the scale will not be used for a prolonged amount of time, remove the battery. Hang the scale at all times and do not allow it to rest on the ground.

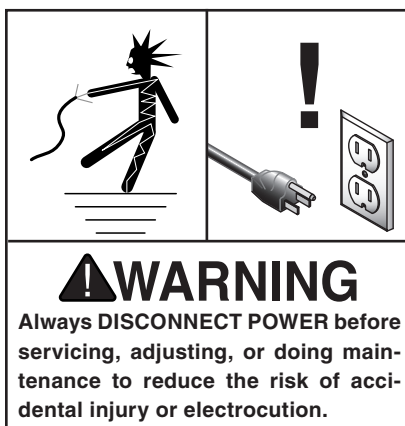

BATTERY MUST BE RECYCLED OR DISPOSED OF PROPERLY. Consult your local disposal company for recycling options in your area.

SECTION 6: SERVICE

Troubleshooting

Symptom	Possible Cause	Solution
No display when the scale is turned ON .	<ol style="list-style-type: none">1. Battery is dead or damaged.2. Battery contact is loose.	<ol style="list-style-type: none">1. Check and charge or replace battery.2. Tighten the battery contact.
Display flashes.	<ol style="list-style-type: none">1. Low battery.	<ol style="list-style-type: none">1. Recharge battery.
Scale will not turn ON or OFF .	<ol style="list-style-type: none">1. ON/OFF button is damaged.2. Scale is still in function mode.	<ol style="list-style-type: none">1. Check and clean the button and button contact.2. Exit out of the function to the main screen, then turn OFF the scale.
Display will not show a stable weight.	<ol style="list-style-type: none">1. The load is unstable.2. Load cell cable is damaged.3. The scale has been in a damp environment for a prolonged amount of time.	<ol style="list-style-type: none">1. Stabilize the load.2. Check and replace load cell.3. Put the scale in a dry environment.
Recharge indicator light will not turn ON .	<ol style="list-style-type: none">1. Damaged adaptor.2. The adaptor is not fully plugged into the scale or outlet.	<ol style="list-style-type: none">1. Check or replace the adaptor.2. Insert the plug again.
Scale unable to tare.	<ol style="list-style-type: none">1. Damaged TARE button.	<ol style="list-style-type: none">1. Check and clean the button and button contact.
Large weight error.	<ol style="list-style-type: none">1. Scale is not hung properly.	<ol style="list-style-type: none">1. Check the scale, harnesses, etc. Review Setup section on Page 4.
Battery unable to charge.	<ol style="list-style-type: none">1. Battery is damaged.2. Outlet is damaged.	<ol style="list-style-type: none">1. Replace the battery.2. Replace the outlet.
Remote will not work.	<ol style="list-style-type: none">1. Remote control is too far away from the scale2. Dirty receiver window.3. Remote control batteries are low.	<ol style="list-style-type: none">1. Move the remote closer to the scale.2. Check and clean window.3. Replace controller batteries.
The display will not show "0" with an empty load.	<ol style="list-style-type: none">1. The scale has not had enough time to warm up.2. The scale has been placed on the ground and not hung for a prolonged time.	<ol style="list-style-type: none">1. Allow the scale to warm up for 3-5 minutes after turning it on.2. Hang the scale.

T10006 Parts Breakdown

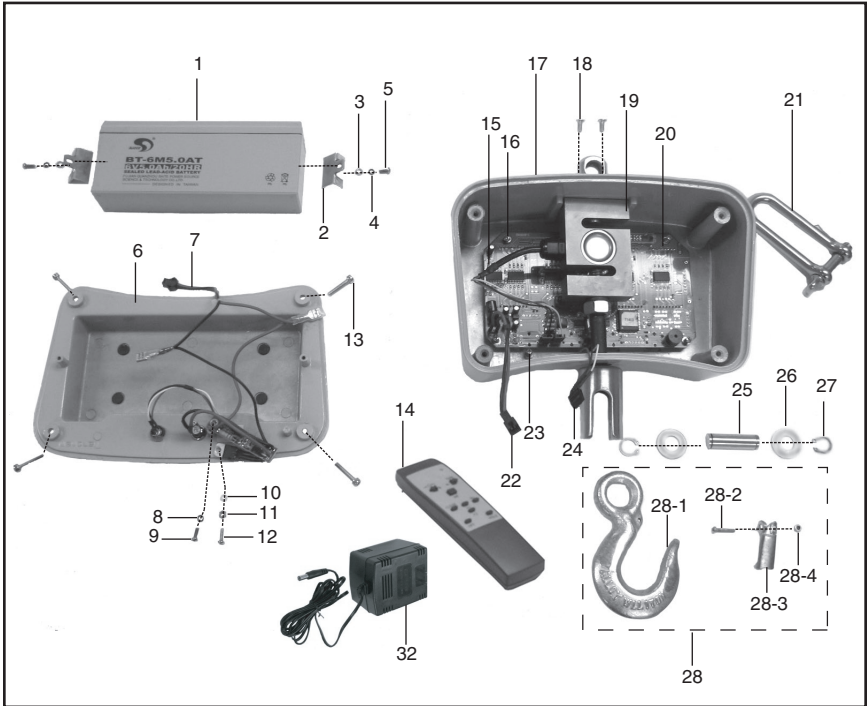

REF PART #	DESCRIPTION
1	PT10006001 SCALE BATTERY 6V
2	PT10006002 BRACKET
3	PW07M FLAT WASHER 3MM
4	PLW09M LOCK WASHER 3MM
5	PS79M PHLP HD SCR M3-.5 X 8
6	PT10006006 BACK PANEL
7	PT10006007 BACK PANEL WIRE ASSEMBLY
8	PLW09M LOCK WASHER 3MM
9	PS79M PHLP HD SCR M3-.5 X 8
10	PT10006010 SPACER
11	PN07M HEX NUT M3-5
12	PS55M PHLP HD SCR M3-.5 X 10
13	PSB39M CAP SCREW M4-.7 X 20
14	PT10006014 REMOTE CONTROL
15	PT10006015 LOAD CELL WIRE ASSEMBLY
16	PS79M PHLP HD SCR M3-.5 X 8
17	PT10006017 FRONT PANEL

REF PART #	DESCRIPTION
18	PFH07M FLAT HD SCR M5-8 X 10
19	PT10006019 LOAD CELL ASSEMBLY
20	PT10006020 CIRCUIT BOARD
21	PT10006021 LONG BOW SHACKLE ASSEMBLY
22	PT10006022 TWO WIRE ASSEMBLY
23	PS111M PHLP HD SCR M3-.5 X 4
24	PT10006024 THREE WIRE ASSEMBLY
25	PT10006025 GRVD HDLESS CLEVIS PIN 12 X 40
26	PW06M FLAT WASHER 12MM
27	PR48M EXT RETAINING RING 11MM
28	PT10006028 HOOK ASSEMBLY
28-1	PT10006028-1 HOOK
28-2	PS98M PHLP HD SCR M3-.5 X 16
28-3	PT10006028-3 SAFETY LATCH
28-4	PLN13M LOCK NUT M3-.5
32	PT10006032 BATTERY CHARGER

WARRANTY

Grizzly Industrial, Inc. warrants every product it sells for a period of **1 year** to the original purchaser from the date of purchase. This warranty does not apply to defects due directly or indirectly to misuse, abuse, negligence, accidents, repairs or alterations or lack of maintenance. This is Grizzly's sole written warranty and any and all warranties that may be implied by law, including any merchantability or fitness, for any particular purpose, are hereby limited to the duration of this written warranty. We do not warrant or represent that the merchandise complies with the provisions of any law or acts unless the manufacturer so warrants. In no event shall Grizzly's liability under this warranty exceed the purchase price paid for the product and any legal actions brought against Grizzly shall be tried in the State of Washington, County of Whatcom.

We shall in no event be liable for death, injuries to persons or property or for incidental, contingent, special, or consequential damages arising from the use of our products.

To take advantage of this warranty, contact us by mail or phone and give us all the details. We will then issue you a "Return Authorization Number," which must be clearly posted on the outside as well as the inside of the carton. We will not accept any item back without this number. Proof of purchase must accompany the merchandise.

The manufacturers reserve the right to change specifications at any time because they constantly strive to achieve better quality equipment. We make every effort to ensure that our products meet high quality and durability standards and we hope you never need to use this warranty.

Please feel free to write or call us if you have any questions about the machine or the manual.

Grizzly Industrial, Inc.
1203 Lycoming Mall Circle
Muncy, PA 17756
Phone: (570) 546-9663
Fax: (800) 438-5901

E-Mail:
techsupport@grizzly.com

Web Site: <http://www.grizzly.com>

Thank you again for your business and continued support. We hope to serve you again soon!

Free Manuals Download Website

<http://myh66.com>

<http://usermanuals.us>

<http://www.somanuals.com>

<http://www.4manuals.cc>

<http://www.manual-lib.com>

<http://www.404manual.com>

<http://www.luxmanual.com>

<http://aubethermostatmanual.com>

Golf course search by state

<http://golfingnear.com>

Email search by domain

<http://emailbydomain.com>

Auto manuals search

<http://auto.somanuals.com>

TV manuals search

<http://tv.somanuals.com>