



MODEL W1713 16" Scroll Saw



INSTRUCTION MANUAL

Phone: 1-360-734-3482 • On-Line Technical Support: tech-support@woodstockint.com

COPYRIGHT © AUGUST, 2003 BY WOODSTOCK INTERNATIONAL, INC.

WARNING: NO PORTION OF THIS MANUAL MAY BE REPRODUCED IN ANY SHAPE OR FORM WITHOUT
THE WRITTEN APPROVAL OF WOODSTOCK INTERNATIONAL, INC.

Printed in China

WARNING

Some dust created by power sanding, sawing, grinding, drilling, and other construction activities contains chemicals known to the State of California to cause cancer, birth defects or other reproductive harm. Some examples of these chemicals are:

- Lead from lead-based paints.
- Crystalline silica from bricks, cement, and other masonry products.
- Arsenic and chromium from chemically treated lumber.

Your risk from these exposures varies, depending on how often you do this type of work. To reduce your exposure to these chemicals: work in a well ventilated area, and work with approved safety equipment, such as those dust masks that are specially designed to filter out microscopic particles.

CONTENTS

INTRODUCTION	2
About Your New Scroll Saw	2
Woodstock Service And Support	2
Warranty And Returns.....	3
Specifications	3
SAFETY	4
Standard Safety Instructions	4
Know Your Machine	6
Safety Instructions for Your Scroll Saw.....	7
ELECTRICAL REQUIREMENTS	8
110V Operation.....	8
Extension Cords	8
Grounding	8
ASSEMBLY	9
Unpacking	9
Inventory	9
Shop Preparation	10
Dust Collection	10
Initial Cleaning	10
Mounting Scroll Saw	11
Table Prep	11
Blade Guard	11
Installing Pin-End Blades	12
Installing Pain-End Blades.....	13
ADJUSTMENTS	14
Drop Foot	14
Sawdust Blower	14
Scale Calibration	15
Blade Tension	15
OPERATIONS	16
Test Run	16
Blade Information	17
Blade Speed	17
Blade Selection Table	17
Standard Scroll Cutting	18
Interior Scroll Cutting	18
MAINTENANCE	19
General.....	19
Arm Bearings	19
Motor Brushes.....	19
Parts	21



INTRODUCTION

About Your New Scroll Saw

Your new **SHOP FOX**® Model W1713 16" Scroll Saw is specially designed to provide many years of trouble-free service. Close attention to engineering detail, ruggedly built parts, and a rigid quality control program assure safe and reliable operation.

The **SHOP FOX**® Model W1713 16" Scroll Saw features variable speed blade control, extra large working table, and cast iron construction. The **SHOP FOX**® Scroll Saw also offers a gooseneck work light, a dust blower, a dust port, a 45° table tilt capacity, and an easy blade change system. Uses standard plain and pin end saw blades.

For more features and details, refer to the **Specifications** section in this manual.

Woodstock International, Inc. is committed to customer satisfaction in providing this manual. It is our intent to include all the information necessary for safety, ease of assembly, practical use and durability of this product.

If you need the latest edition of this manual, you can download it from <http://www.shopfox.biz>.
If you still have questions after reading the latest manual, or if you have comments please contact us at:

Woodstock International, Inc.
Attn: Technical Support Department
P.O. Box 2309
Bellingham, WA 98227

Woodstock Service And Support

We stand behind our machines! In the event that a defect is found, parts are missing or questions arise about your machine, please contact Woodstock International Service and Support at 1-360-734-3482 or send e-mail to: tech-support@shopfox.biz. Our knowledgeable staff will help you troubleshoot problems, order parts or arrange warranty returns.

Warranty And Returns

Woodstock International, Inc. warrants all **SHOP FOX**® machinery to be free of defects from workmanship and materials for a period of 2 years from the date of original purchase by the original owner. This warranty does not apply to defects due directly or indirectly to misuse, abuse, negligence or accidents, lack of maintenance, or to repairs or alterations made or specifically authorized by anyone other than Woodstock International, Inc.

Woodstock International, Inc. will repair or replace, at its expense and at its option, the **SHOP FOX**® machine or machine part which in normal use has proven to be defective, provided that the original owner returns the product prepaid to the **SHOP FOX**® factory service center or authorized repair facility designated by our Bellingham, WA office, with proof of their purchase of the product within 2 years, and provides Woodstock International, Inc. reasonable opportunity to verify the alleged defect through inspection. If it is determined there is no defect, or that the defect resulted from causes not within the scope of Woodstock International Inc.'s warranty, then the original owner must bear the cost of storing and returning the product.

This is Woodstock International, Inc.'s sole written warranty and any and all warranties that may be implied by law, including any merchantability or fitness, for any particular purpose, are hereby limited to the duration of this written warranty. We do not warrant that **SHOP FOX**® machinery complies with the provisions of any law or acts. In no event shall Woodstock International, Inc.'s liability under this warranty exceed the purchase price paid for the product, and any legal actions brought against Woodstock International, Inc. shall be tried in the State of Washington, County of Whatcom. We shall in no event be liable for death, injuries to persons or property or for incidental, contingent, special or consequential damages arising from the use of our products.

Every effort has been made to ensure that all **SHOP FOX**® machinery meets high quality and durability standards. We reserve the right to change specifications at any time because of our commitment to continuously improve the quality of our products.

Specifications

Motor Size	1/8 HP
Motor Speed.....	Variable
No Load Speed	550-1700 SPM
Amp Draw	0.8 A
Blade Stroke.....	3/4"
Maximum Cutting Width.....	16"
Minimum Cutting Thickness	2"
Machine Weight	31 lbs

SAFETY

**READ MANUAL BEFORE OPERATING MACHINE.
FAILURE TO FOLLOW INSTRUCTIONS BELOW WILL
RESULT IN PERSONAL INJURY.**



Indicates an imminently hazardous situation which, if not avoided, WILL result in death or serious injury.



Indicates a potentially hazardous situation which, if not avoided, COULD result in death or serious injury.



Indicates a potentially hazardous situation which, if not avoided, MAY result in minor or moderate injury, MAY result in property damage.

NOTICE

This symbol is used to alert the user to useful information about proper operation of the equipment.

Standard Safety Instructions

1. **Thoroughly read the instruction manual before operating your machine.** Learn the applications, limitations and potential hazards of this machine. Keep manual in a safe, convenient place for future reference.
2. **Keep work area clean and well lit.** Clutter and inadequate lighting invite potential hazards.
3. **Ground all tools.** If a machine is equipped with a three-prong plug, it must be plugged into a three-hole grounded electrical receptacle or grounded extension cord. If using an adapter to aid in accommodating a two-hole receptacle, ground using a screw to a known ground.
4. **Wear eye protection at all times.** Use safety glasses with side shields or safety goggles that meet the appropriate standards of the American National Standards Institute (ANSI).
5. **Avoid dangerous environments. DO NOT** operate this machine in wet or open flame environments. Airborne dust particles could cause an explosion and severe fire hazard.
6. **Ensure all guards are securely in place** and in working condition.
7. **Make sure the machine power switch is in the OFF position** before connecting power to machine.
8. **Keep the work area clean, free of clutter, grease, etc.**
9. **Keep children and visitors away.** Visitors should be kept at a safe distance while operating unit.
10. **Childproof your workshop** with padlocks, master switches or by removing starter keys.
11. **Stop and disconnect the machine when cleaning, adjusting or servicing.**

12. **DO NOT force tool.** The machine will do a safer and better job at the rate for which it was designed.
13. **Use correct tool. DO NOT force machine or attachment to do a job for which it was not designed.**
14. **Wear proper apparel. DO NOT wear loose clothing, neck ties, gloves, jewelry, and secure long hair away from moving parts.**
15. **Remove adjusting keys, rags, and tools.** Before turning the machine on, make it a habit to check that all adjusting keys and wrenches have been removed.
16. **Avoid using an extension cord.** But if you must, examine the extension cord to ensure it is in good condition. Use the "Extension Cord Requirements" table below to determine the correct length and gauge of extension cord needed for your particular needs. The amp rating of the motor can be found on its nameplate. If the motor is dual voltage, be sure to use the amp rating for the voltage you will be using. If you use an extension cord with an undersized gauge or one that is too long, excessive heat will be generated within the circuit, increasing the chance of a fire or damage to the circuit. Always use an extension cord that uses a ground pin and connected ground wire. Immediately replace a damaged extension cord.
17. **Keep proper footing and balance at all times and lock mobile base from freely rolling before using your machine.**
18. **DO NOT leave machine unattended.** Wait until it comes to a complete stop before leaving the area.
19. **Perform machine maintenance and care.** Follow lubrication and accessory attachment instructions in the manual.
20. **Keep machine away from open flame.** Operating machines near pilot lights and/or open flames creates a high risk if dust is dispersed in the area. Dust particles and an ignition source may cause an explosion. **DO NOT** operate the machine in high-risk areas, including but not limited to, those mentioned above.
21. **If at any time you are experiencing difficulties performing the intended operation, stop using the machine!** Contact our service department or ask a qualified expert how the operation should be performed.
22. **Habits are hard to break.** Develop good habits in your shop and consistent safety practices will become second-nature to you.

Extension Cord Requirements

Amp Rating	Length And Gauge		
	25ft	50ft	100ft
0-6	#16	#16	#16
7-10	#16	#16	#14
11-12	#16	#16	#14
13-16	#14	#12	#12
17-20	#12	#12	#10
21-30	#10	#10	No

⚠ WARNING

Operating this equipment creates the potential for flying debris to cause eye injury. Always wear safety glasses or goggles when operating equipment. Everyday glasses or reading glasses only have impact resistant lenses, they are not safety glasses. Be certain the safety glasses you wear meet the appropriate standards of the American National Standards Institute (ANSI).





Know Your Machine

An important part of safety is knowing your machine and its components. Please take the time to learn the items shown in the pictures below. The letters in the picture correspond to the following descriptions in the list.

SAFETY

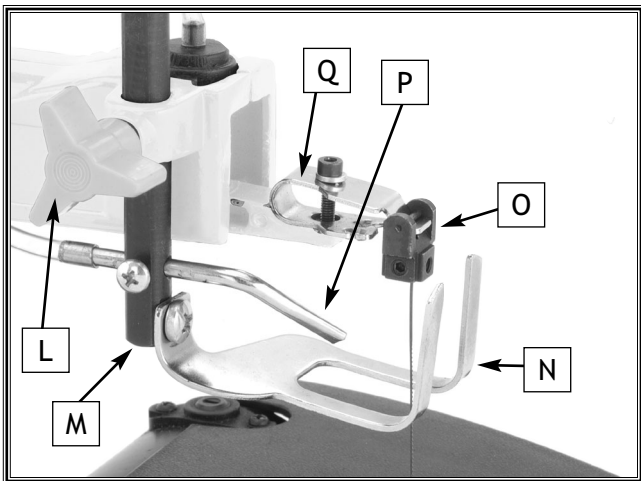
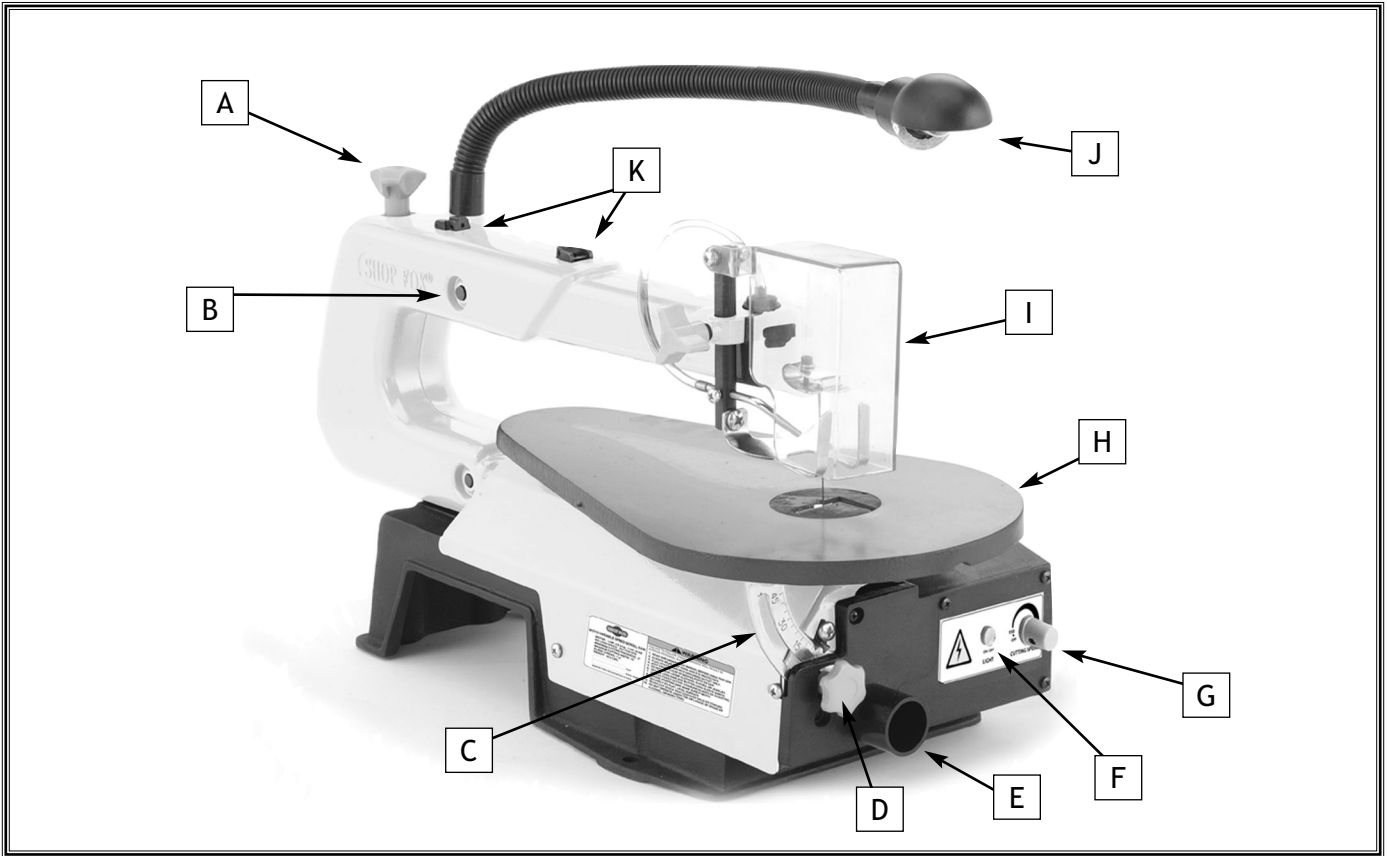

- A. Blade Tension Knob
- B. Arm Bearing
- C. Table Bevel Scale
- D. Table Lock Knob
- E. Dust Port
- F. Light Button
- G. Variable Speed/Power Knob
- H. Table
- I. Blade Guard
- J. Work Light
- K. Blade Adapter
- L. Drop Foot Rod Lock Knob
- M. Drop Foot Rod
- N. Drop Foot
- O. Blade Adapter (Mounted)
- P. Sawdust Blower
- Q. Upper Blade Holder

Safety Instructions for Your Scroll Saw



⚠️ WARNING
 READ and understand this entire instruction manual before using this machine. Serious personal injury may occur if safety and operational information is not understood and followed. **DO NOT** risk your safety by not reading!

⚠️ CAUTION
 Use this and other machinery with caution and respect. Always consider safety first, as it applies to your individual working conditions. No list of safety guidelines can be complete—every shop environment is different. Failure to follow guidelines could result in serious personal injury, damage to equipment or poor work results.

SAFETY

1. **SAW SAFETY BEGINS WITH YOUR LUMBER.** Inspect your workpiece carefully before you feed it into the saw. If you have any doubts about the stability or structural integrity of your workpiece, **DO NOT SAW IT!**
2. **AVOID AWKWARD OPERATIONS AND HAND POSITIONS** where a sudden slip could cause your hand to move into the blade. Always make sure you have good balance.
3. **KEEP HANDS AWAY FROM CUTTING AREA.** **DO NOT** hand hold pieces so small that your fingers go under the blade guard. **DO NOT** reach underneath work or in blade cutting path with your hands and fingers for any reason.
4. **FIRMLY CLAMP OR BOLT** your saw to a stable, level workbench or table. The best height is waist level.
5. **USE ONLY CORRECT BLADES.** Use the correct blade size, style and cutting speed for the material and type of cut.
6. **ALWAYS SUPPORT LARGE WORKPIECES** while cutting to minimize blade pinching and blade breakage. The saw may slip, walk or slide when cutting large or heavy workpieces.
7. **DO NOT REMOVE JAMMED CUT-OFF PIECES UNTIL THE BLADE HAS COME TO A COMPLETE STOP.**
8. **NEVER START THE SAW WHEN THE BLADE IS IN CONTACT WITH THE WORKPIECE.**
9. **BEFORE CHANGING THE SETUP, REMOVING COVERS, GUARDS OR BLADES,** unplug the saw from the power source and remove the switch safety key.
10. **NEVER PERFORM CUTTING OPERATIONS WITH THE BLADE GUARD REMOVED.**
11. **BE AWARE THAT CERTAIN WOODS MAY CAUSE AN ALLERGIC REACTION** in people and animals, especially when exposed to fine dust. Make sure you know what type of wood dust you will be exposed to and always wear an approved respirator

ELECTRICAL REQUIREMENTS

110V Operation

The SHOP FOX® Model W1713 motor draws approximately 0.8 amps.

Since other machines may be using the same circuit, make sure the circuit, circuit breaker, or fuse can carry the total load without tripping. If the total amperage load of all machines and the scroll saw exceeds the amperage rating of the circuit breaker or fuse, use a different circuit that can carry the load.

DO NOT modify an existing low-amperage circuit by only replacing the circuit breaker with a breaker rated for a higher amperage. The breaker and the complete circuit must be replaced by a qualified electrician, otherwise the wires can overheat and cause a fire.

Extension Cords

If you must use an extension cord with the Model W1713, please follow these requirements:

- Use a cord rated for Standard Service (Grade S).
- Use a 16 AWG cord that is 100 feet or less
- Use a cord with a ground pin
- Use an undamaged cord only

Grounding

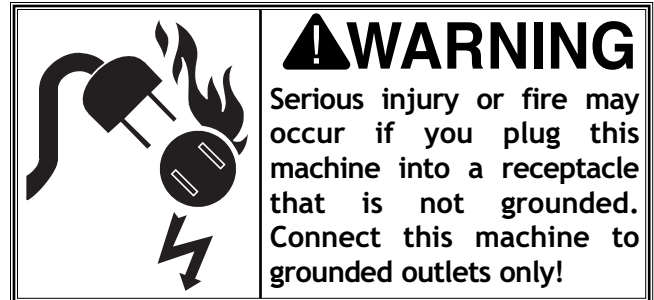

Ground this machine! The electrical cord supplied with the SHOP FOX® Model W1713 Scroll saw has a three prong plug for grounded outlets. See Figure 1. If your power receptacle does not have a ground pin hole, have the receptacle replaced by a qualified electrician, or have an appropriate adapter installed and grounded properly. NEVER cut the ground pin off so your scroll saw will plug into a non-grounded receptacle.

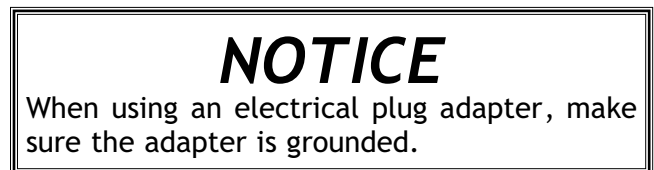

Remember, an adapter with a grounding wire does not guarantee the scroll saw is grounded. A ground source must always be verified in the electrical circuit within the wall or conduit.

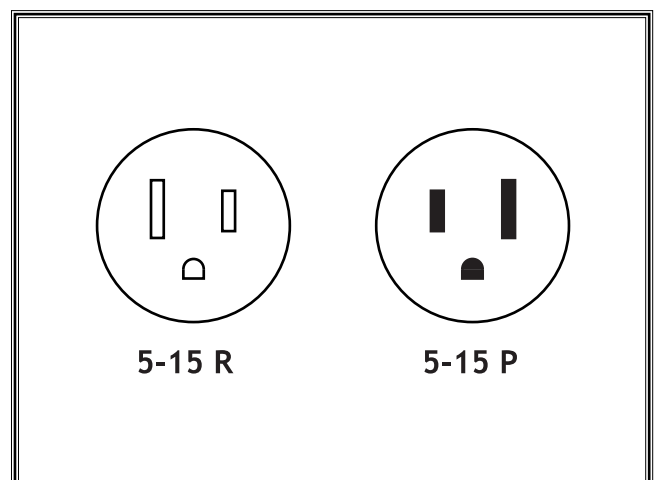

Figure 1. NEMA-style 5-15 plug and receptacle.

ASSEMBLY

Unpacking

The Model W1713 was carefully packed when it left our warehouse. If you receive it damaged or missing any parts, please contact Woodstock International Service and Support at 1-360-734-3482 or send e-mail to: tech-support@shopfox.biz.

Inventory

Layout and inventory the package contents listed below and familiarize, yourself with the components shown in **Figure 8** to ease assembly.

Item	Qty.
1. Scroll Saw Unit	1
2. 4mm Allen Wrench	1
3. 3mm T-Handle Allen Wrench	1
4. Saw Blades	2
5. Blade Guard	1
6. Blade Adapters	2



⚠ WARNING

Read and understand this entire instruction manual before performing any operations with your machine. Serious personal injury may occur if safety and operational information is not understood and followed.



⚠ CAUTION

The Model W1713 is a heavy machine at 31 lbs. Use assistance when lifting or moving the machine.

ASSEMBLY

Shop Preparation

	<p>⚠ CAUTION ONLY ALLOW TRAINED PEOPLE in your shop! Make sure shop entrances are locked and machines are correctly turned off with lock-out devices when not in use. Otherwise, injury or death can occur.</p>
--	--

- **Lighting:** Lighting should be bright enough to eliminate shadows and prevent eye strain.
- **Working Clearances:** Consider your current and future shop needs with respect to the safe operation of this machine.
- **Outlets:** Make sure the electrical circuits have the capacity to handle the amperage requirements for your Model W1713. Refer to **page 8** for more information. Electrical outlets should be located near the lathe, so power or extension cords are clear of high-traffic areas.

Dust Collection

	<p>⚠ CAUTION THIS MACHINE produces sawdust that may cause allergic reactions or respiratory problems. Wear a respirator in addition to using a dust collection system.</p>
--	---

For information on the correct dust collection components for the scroll saw, contact your Woodstock International dealer for a copy of the Dust Collection Basics handbook and available accessories.

Initial Cleaning

The exposed and unpainted scroll saw surfaces are coated with a waxy oil to prevent rust during storage and shipment. **DO NOT** use chlorine based solutions or solvents to remove the this waxy oil, or you will damage the painted surfaces. Remove the waxy oil with a solvent based degreaser before you use the scroll saw. Always follow all usage and safety instructions of the product that you are using.

	<p>⚠ WARNING DO NOT use flammables such as gas or other petroleum-based solvents to clean your machine. These products have low flash points and present the risk of explosion and severe personal injury!</p>
--	---

	<p>⚠ WARNING DO NOT smoke while using cleaning solvents. Smoking may cause explosion or risk of fire when exposed to these products!</p>
--	---

	<p>⚠ CAUTION ALWAYS work in a well ventilated area when using solvents with fumes, and keep away from any potential ignition sources (pilot lights). Most solvents used to clean machinery are toxic when inhaled or ingested. Always dispose of waste rags in a sealed container to make sure they do not cause fire or environmental hazards.</p>

Mounting Scroll Saw

The scroll saw can be mounted to a workbench two ways:

- Permanent mounting can be accomplished by bolting the base to the workbench. *Because workbench table thickness can vary, fasteners have not been supplied.*
- Temporary mounting can be accomplished by securing the base of the scroll saw to a piece of $\frac{3}{4}$ " plywood that measures at least 21" x 14". The scroll saw/plywood assembly can then be temporarily clamped to a workbench or other suitable working surface.

Vibration caused by operating the scroll saw can be reduced by placing a foam pad or piece of carpet between the saw base and the workbench.

Table Prep

To prepare the table surface for workpieces, do these steps:

Clean the table surface with a rust preventative such as SLIPIT®.

Blade Guard

The blade guard must be installed before turning the scroll saw ON and before performing a cutting operation.

To install the blade guard, do these steps:

1. **UNPLUG THE SCROLL SAW!**
2. Using the supplied screw, nut, and washers, install the clear blade guard onto the drop foot rod (**Figure 2**). *Over-tightening the bolt could break the clear plastic arms of the blade guard.*
3. Swing the blade guard up and down to ensure that it moves smoothly.

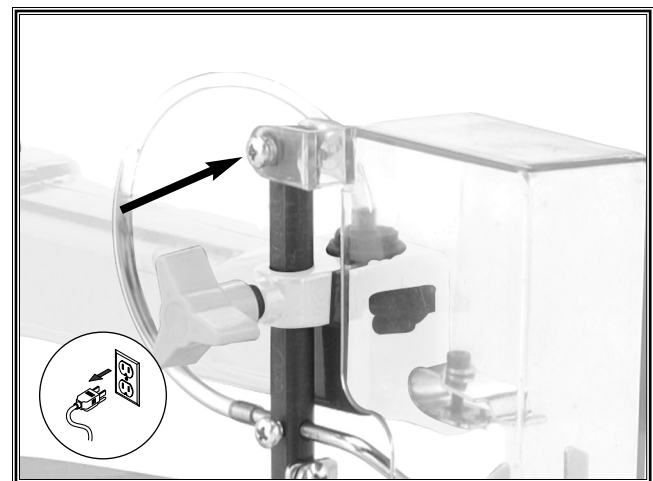
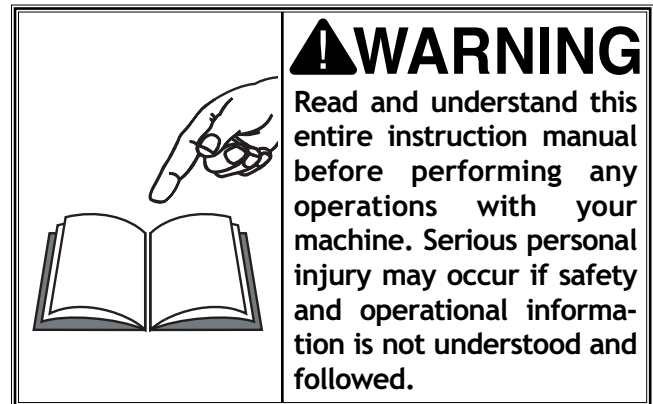
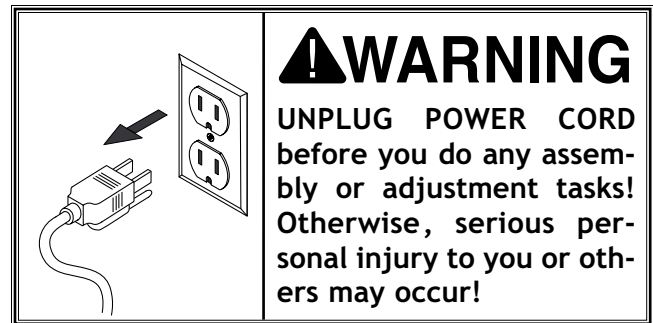

Figure 2. Blade guard mounting location.

Installing Pin-End Blades

Scroll saw blades are classified as either “pin end” or “plain end.” The blade included with this saw is a pin end blade.

To install a pin end blade, do these steps:

1. **UNPLUG THE SCROLL SAW!**
2. Turn the tension adjustment knob counter-clockwise to decrease the tension.
3. Remove the throat plate and slide the saw blade down through the table insert hole so the teeth face forward and down.
4. Slide the lower blade end through the V-notch on the lower blade holder (**Figure 3**).
5. Press the upper blade holder downward and slide the upper blade end through the V-notch (**Figure 4**).
6. Turn the tension adjustment knob clockwise to increase the blade tension to the desired amount.
7. Replace the throat plate removed in **step 3**.



Figure 3. V-notch on lower blade holder.

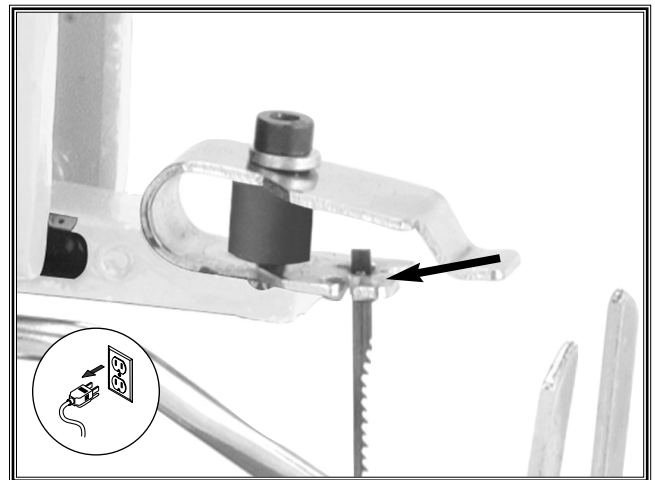

Figure 4. V-notch on upper blade holder.

ASSEMBLY

Installing Plain-End Blades

Using plain end blades requires the use of blade adapters. The blade adapters attach to each end of the saw blade, allowing plain end blade to be installed on the upper and lower blade holders.

To install a plain end blade, do these steps:

1. **UNPLUG THE SCROLL SAW!**
2. Turn the tension adjustment knob counter-clockwise to decrease the tension.
3. Loosen the setscrews (**Figure 5**) on the blade adapters to allow the saw blade ends to slide through the mounting holes. *The setscrews can be threaded into either set of holes depending on whether side cutting or straight cutting is desired.*
4. Position the blade adapters in the gauge on top of the scroll saw (**Figure 6**) to correctly set the blade length.
5. Tighten the blade adapter setscrews to securely position the blade in the center of the mounting holes
6. Remove the throat plate and slide the saw blade down through the table insert hole so the teeth face forward and down.
7. Slide the lower blade adapter over the mounting arm of the lower blade holder. Then, press the upper blade holder downward and slide the upper blade adapter over the mounting arm of the upper blade holder (**Figure 7**).
8. Turn the tension adjustment knob clockwise to increase the blade tension to the desired amount.
9. Replace the throat plate removed in **step 6**.

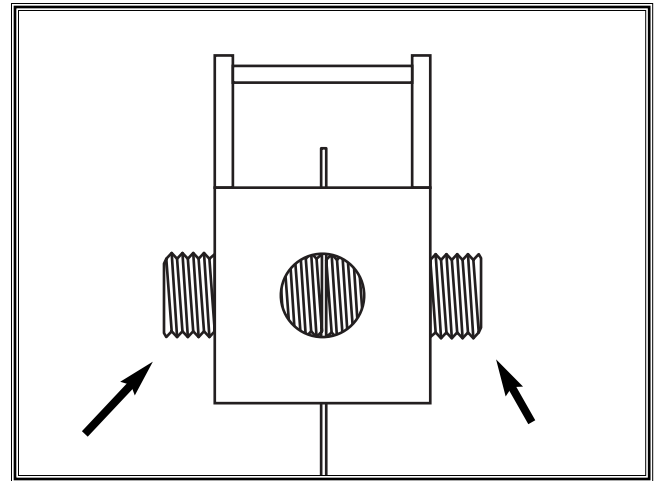

Figure 5. Blade adapter setscrews.

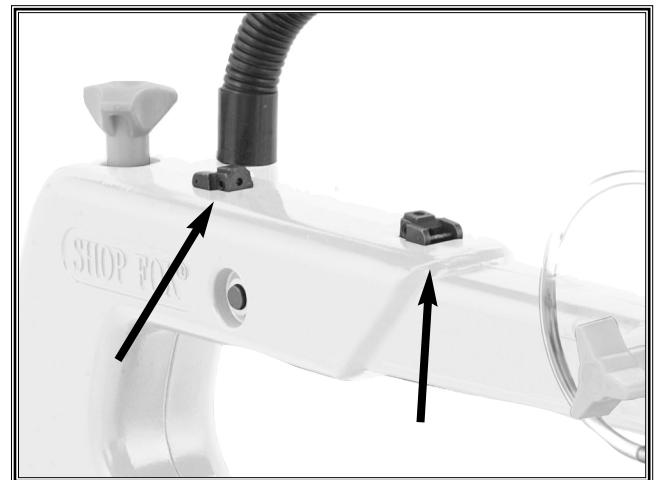

Figure 6. Blade adapters in the gauge on top of the scroll saw.

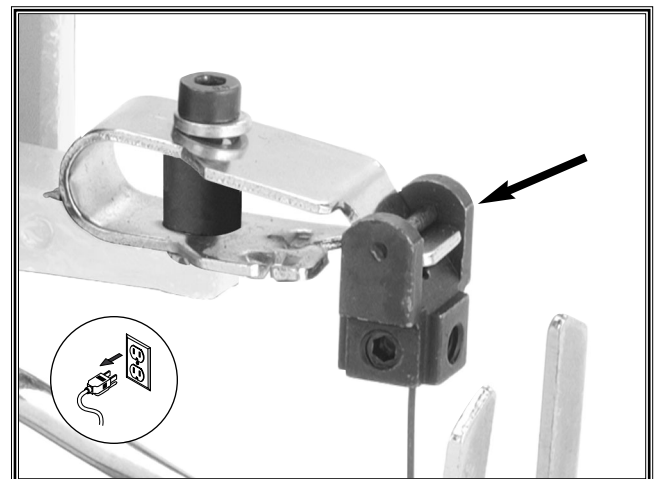

Figure 7. Blade adapter on the upper blade holder.

ADJUSTMENTS

Drop Foot

The drop foot must be adjusted to hold the workpiece against the table during cutting operations. The front of the drop foot also acts as a blade guard, preventing the operator's fingers from coming into contact with the blade.

To adjust the drop foot, do these steps:

1. Loosen the drop foot lock knob (Figure 8).
2. Adjust the drop foot so it makes contact with the workpiece.
3. Retighten the drop foot lock knob.

The bottom face of the drop foot must always be parallel to the top face of the table.

Sawdust Blower

The sawdust blower directs a current of air onto the cut line, blowing the sawdust from the workpiece.

To adjust the sawdust blower, do these steps:

1. Loosen the phillips head screw on the side of the drop foot rod (Figure 8).
2. Adjust the sawdust blower to the desired position.

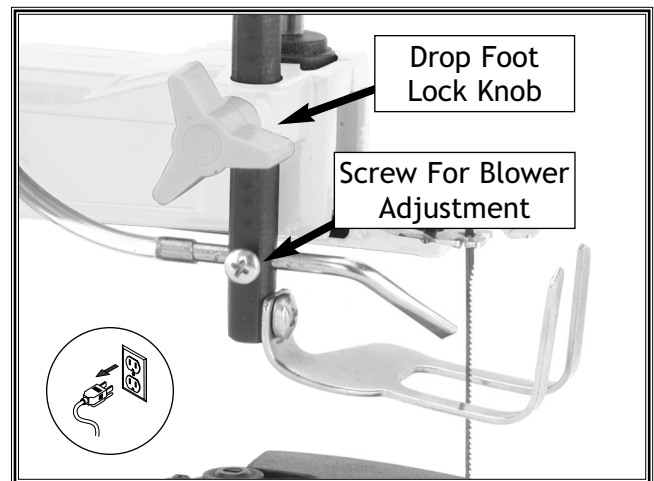
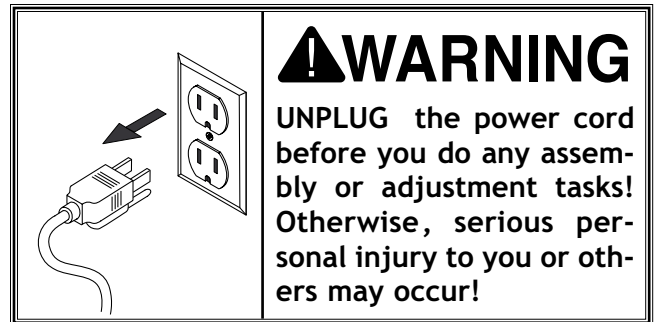

Figure 8. Upper saw adjustments.

ASSEMBLY

Scale Calibration

To calibrate the scale, do these steps:

1. Loosen the table lock knob (Figure 9).
2. Using a machinist's square, adjust the table square to the saw blade. Retighten the table lock knob.
3. Adjust the angle scale pointer to the 0° mark (Figure 9).
4. Adjust the table stop bolt so it makes contact with the underside of the table.

The angle scale is only a rough scale and should not be used to set the table for precise angle cuts.

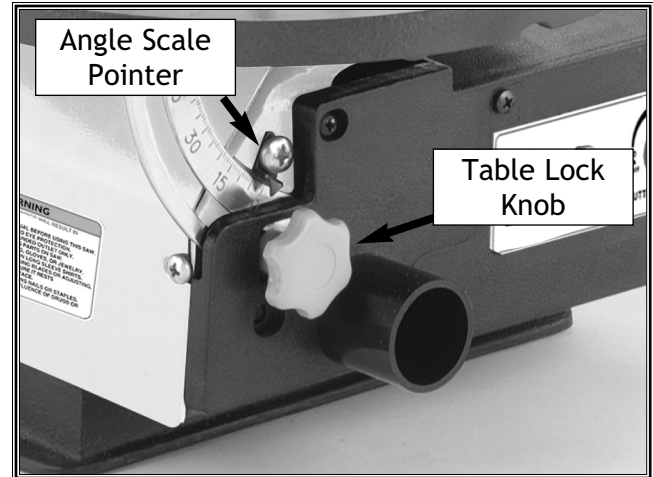

Figure 9. Lower saw adjustments.

Blade Tension

Correct blade tension is essential to maximizing the performance of the scroll saw. Blades that are tensioned correctly will also last longer and are less likely to break during a cutting operation; however, finding the correct amount of tension for the saw blade is a subjective matter that often results in trial-and-error adjustments.

Having too little tension on the blade is safer than having too much. If the blade is tensioned too tight, the blade could break, causing serious personal injury. If the blade is tensioned too loose, the blade will more than likely fall off during the cutting operation.

To adjust the blade tension, do these steps:

- Turn the blade tension knob (Figure 10) clockwise to increase the blade tension.
- Turn the blade tension knob counter-clockwise to decrease the blade tension.

Get into the habit of plucking the saw blade every time the blade is replaced or re-installed. With time and experience, a distinct sound will be recognized as the "correct" blade tension.



Figure 10. Blade tension knob.

OPERATIONS

Test Run

Once assembly is complete, the machine is ready for a test run. The purpose of a test run is to identify any unusual noises and vibrations, as well as to confirm that the machine is performing as intended.

To test run the Model W1713, do these steps:

1. Make sure that all tools have been removed from the scroll saw.
2. Turn the variable speed/power knob clockwise to turn the scroll saw ON.
3. Once the scroll saw is running, listen for any unusual noises. The machine should run smoothly with little or no vibrations.
 - If there are any unusual noises or vibrations, stop the scroll saw immediately by pushing the paddle switch down.
4. Unplug the scroll saw and investigate the source of the noise or vibration. DO NOT make any adjustments to the scroll saw while it is plugged in. The scroll saw should not be run any further until the problems are corrected.

	<p>! WARNING THIS MACHINE throws wood chips and sawdust. Wear safety glasses or a face shield during all operations.</p>
--	---

	<p>! WARNING KEEP loose clothing rolled up and out of the way of machinery and keep hair pulled back.</p>
--	--

	<p>! CAUTION THIS MACHINE produces sawdust that may cause allergic reactions or respiratory problems. Wear a respirator in addition to using a dust collector.</p>
---	---

Blade Information

Important issues regarding blade performance:

- Scroll saw blades wear out and must be replaced frequently. Typically a blade will stay sharp anywhere from 1/2 to 2 hours depending on how the blade is used and what type of material is being cut.
- Best cutting results will be achieved when cutting material less than 1" thick.
- When cutting material thicker than 1", use a very slow feed rate.
- Blades will become dull quickly whenever making cuts in plywood, hardwoods, and laminates.
- Exerting excessive side pressure on the blade greatly increases the chance of blade breakage.

Blade Speed

To change the blade speed:

The blade speed is variable between 400 and 1600 strokes-per-minute (SPM). Blade speed adjustments are made using the variable speed /power knob (Figure 11) on the front of the scroll saw.

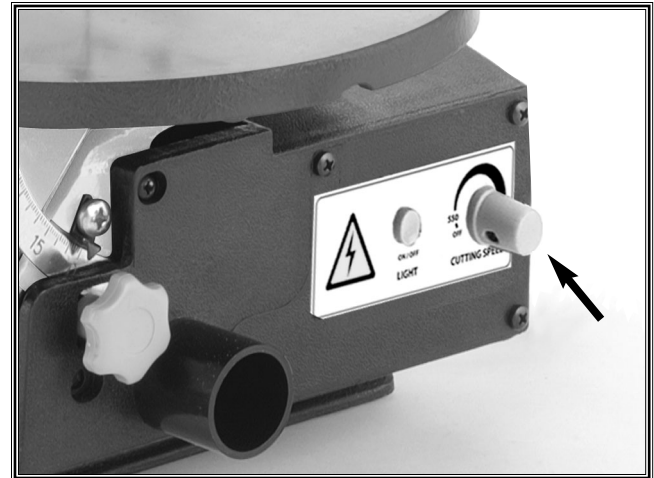

Figure 11. Variable speed/power knob.

Blade Selection Table

Teeth Per Inch	Width	Thickness	Strokes-Per-Minute	Material Being Cut
10	0.110"	0.020"	1200-1600	General purpose blade for cutting hard and soft woods between 3/16" and 2". Also good for plastics, paper, felt, and bone.
15	0.110"	0.020"	600-1200	Good for cutting very thin wood and plastic between 3/32" and 1/2".
18	0.095"	0.010"	400-600	Good for tight radius cutting in thin hard and soft woods between 3/32" and 1/8". Also good for veneer, bone, ivory, and plastics

Standard Scroll Cutting

To perform a standard scroll cutting operation:

For standard scroll cutting, follow the pattern lines on the workpiece by pushing and turning the workpiece at the same time. DO NOT turn the workpiece without pushing it at the same time; otherwise, the blade could twist and break.

Interior Scroll Cutting

The scroll saw can also make internal scroll cuts without having to cut through the perimeter of the workpiece.

To perform an interior scroll cutting operation:

1. **UNPLUG THE SCROLL SAW!**
2. Remove the saw blade.
3. Drill a $\frac{1}{4}$ " hole in the workpiece.
4. Place the hole in the workpiece over the blade hole in the table insert.
5. Re-install the blade by sliding the bottom end of the blade through the workpiece hole. *Note—If a plain end blade is being used, the lower blade adapter may need to be installed after the blade is slid through the workpiece.*
6. Adjust the drop foot onto the surface of the workpiece.
7. Plug the scroll saw in and perform the cutting operation.
8. When the cutting operation is complete, unplug the scroll saw and remove the saw blade.

MAINTENANCE

General

Regular periodic maintenance on your Model W1713 will ensure its optimum performance. Make a habit of inspecting your machine each time you use it. Check for the following conditions and repair or replace when necessary:

- Loose mounting bolts.
- Worn switch.
- Worn or damaged cords and plugs.
- Any other condition that could hamper the safe operation of this machine.

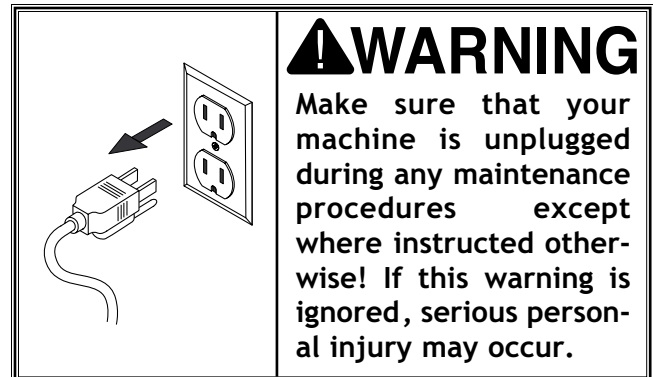

Arm Bearings

The arm bearings (Figure 12) on each side of the scroll saw need to be lubricated after every 6-10 hours of use. Unplug the saw, lay it on its side, and apply a generous amount of SAE 20 oil. Let stand overnight. Perform the same procedure to the opposite side bearings.

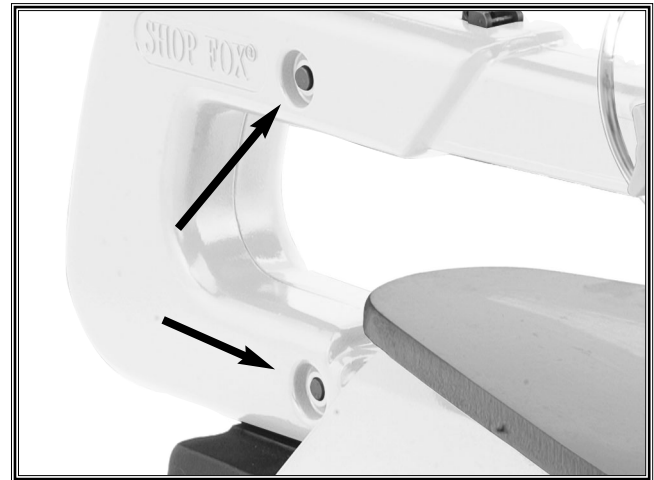

Figure 12. Arm bearings.

Motor Brushes

To replace the motor brushes, do these steps:

1. Using a flat-head screwdriver, remove the motor brush caps. The top cap is accessible from the top of the scroll saw and the bottom cap is accessible through a hole on the bottom of the base (Figure 13).
2. Replace the motor brushes if they are damaged or severely blackened by carbon build-up.
3. Re-install the motor brush caps.



Figure 13. Motor brush cap (1 of 2).

Closure

The following pages contain parts diagrams/lists and a warranty card for your **SHOP FOX®** Model W1713.

If you need parts or help in assembling your machine, or if you need operational information, we encourage you to call our Service Department. Our trained service technicians will be glad to help you.

If you have comments dealing specifically with this manual, please write to us using the address in the General Information. The specifications, drawings, and photographs illustrated in this manual represent the Model W1713 as supplied when the manual was prepared. However, due to Woodstock International, Inc.'s policy of continuous improvement, changes may be made at any time with no obligation on the part of Woodstock International, Inc. Whenever possible, though, we send manual updates to all owners of a particular tool or machine that have registered their purchase with our warranty card. Should you receive one, add the new information to this manual and keep it for reference.

We have included some important safety measures that are essential to this machine's operation. While most safety measures are generally universal, we remind you that each workshop is different and safety rules should be considered as they apply to your specific situation.

We recommend you keep this manual for complete information regarding Woodstock International, Inc.'s warranty and return policy. Should a problem arise, we recommend that you keep your proof of purchase with your manual. If you need additional technical information relating to this machine, or if you need general assistance or replacement parts, please contact the Service Department at 1-360-734-3482 or e-mail: tech-support@shopfox.biz.

Additional information sources are necessary to realize the full potential of this machine. Trade journals, woodworking magazines, and your local library are good places to start.

The Model W1713 is specifically designed for cutting operations. **DO NOT MODIFY AND/OR USE THIS MACHINE FOR ANY OTHER PURPOSE. MODIFICATIONS OR IMPROPER USE OF THIS TOOL WILL VOID THE WARRANTY.** If you are confused about any aspect of this machine, **DO NOT** use it until all your questions have been answered.

Parts

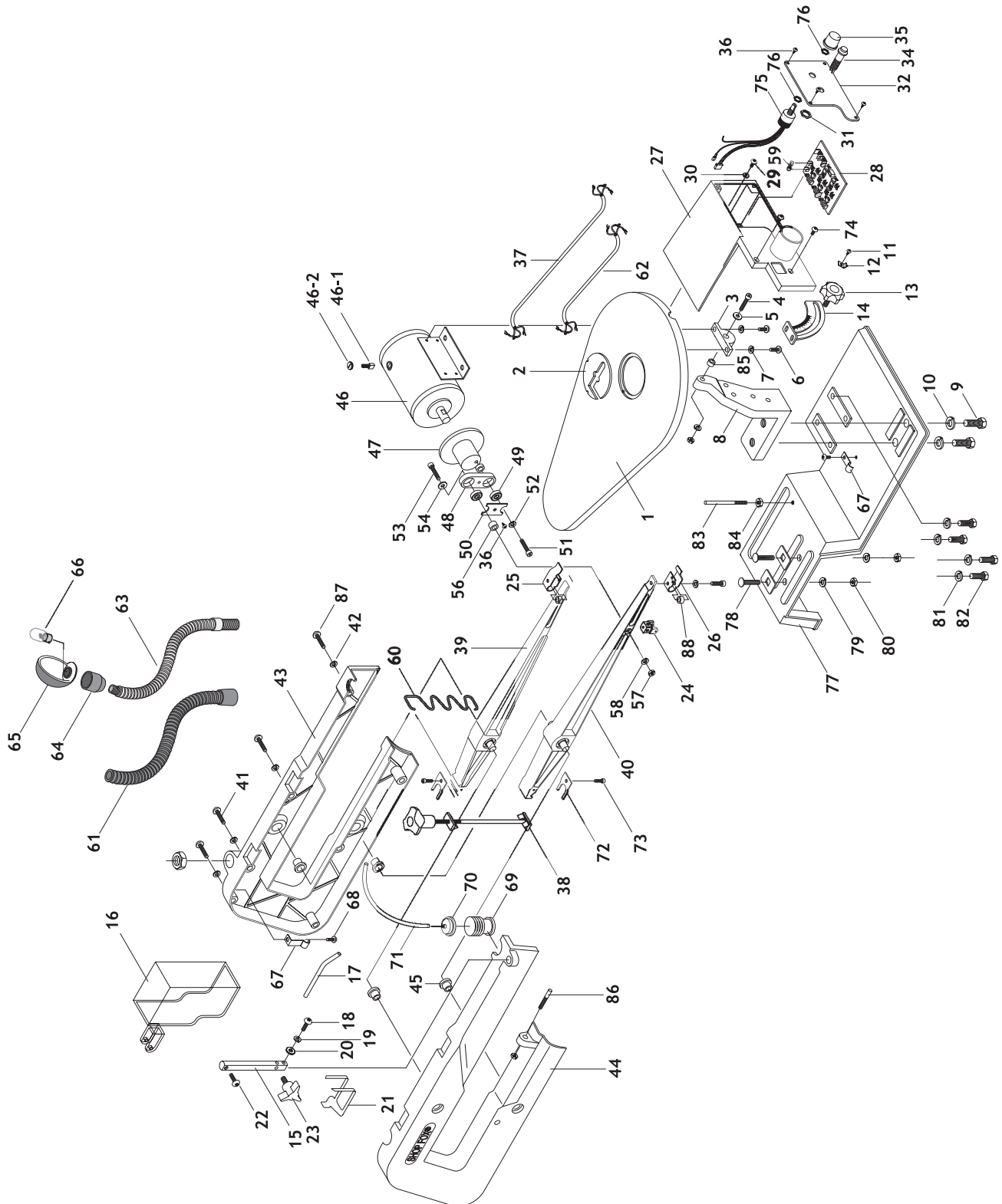

REF	PART #	DESCRIPTION
1	X1713001	TABLE
2	X1713002	TABLE INSERT
3	X1713003	TABLE PIVOT BRACKET
4	XPSB48M	CAP SCREW M6-1 X 35
5	XPW03M	FLAT WASHER 6MM
6	XPS09M	PHLP HD SCR M5-.8 X 10
7	XPLW01M	LOCK WASHER 5MM
8	X1713008	TABLE PEDESTAL
9	XPB07M	HEX BOLT M8-1.25 X 25
10	XPLW04M	LOCK WASHER 8MM
11	XPS65M	PHLP HD SCR M6-1 X 10
12	X1713012	SCALE INDICATOR
13	X1713013	MALE KNOB M6 X 14
14	X1713014	GRADUATED SCALE 0-45°
15	X1713015	AIR HOSE POST
16	X1713016	BLADE GUARD
17	X1713017	AIR HOSE
18	XPS65M	PHLP HD SCR M6-1. X 10
19	XPLW03M	LOCK WASHER 6MM
20	XPW03M	FLAT WASHER 6MM
21	X1713021	HOLD DOWN SHOE
22	XPS09M	PHLP HD SCR M5-.8 X 10
23	X1713023	KNOB BOLT M6-1 X 13
24	X1713024	BLADE CLAMP
25	X1713025	UPPER BLADE GUIDE
26	X1713026	LOWER BLADE GUIDE
27	X1713027	SWITCH BOX HOUSING
28	X1713028	CIRCUIT BOARD
29	XPS02M	PHLP HD SCR M4-.7 X 12
30	XPW05M	FLAT WASHER 4MM
31	XPNO9M	HEX NUT M12-1.75
32	XPLW05M	LOCK WASHER 12MM
33	X1713033	SWITCH BOX COVER
34	X1713034	LIGHT SWITCH
35	X1713035	SPEED CONTROL DIAL
36	XPHTEK7	TAP SCREW #8 X 3/8"
37	X1713037	POWER CORD
38	X1713038	BLADE TENSION ASSEMBLY
39	X1713039	UPPER ARM
40	X1713040	LOWER ARM
41	XPS75M	PHLP HD SCR M5-.8 X 35
42	XPLW01M	LOCK WASHER 5MM
43	X1713043	RIGHT ARM COVER
44	X1713044	LEFT ARM COVER
45	X1713045	BUSHING 3/8"

REF	PART #	DESCRIPTION
46	X1713046	MOTOR
46-1	X1713046-1	CARBON BRUSH
46-2	X1713046-2	CARBON BRUSH CAP
47	X1713047	FLYWHEEL
48	X1713048	LINK
49	XP625	BALL BEARING 625ZZ
50	X1713050	RETAINER
51	XPSB24M	CAP SCREW M5-.8 X 16
52	XPLW01M	LOCK WASHER 5MM
53	XPSB38M	CAP SCREW M5-.8 X 25
54	XPW02M	FLAT WASHER 5MM
55	XPLW02M	LOCK WASHER 4MM
56	X1713056	SPACER 5MM ID X 6MM
57	XPNO6M	HEX NUT M5-.8
58	XPLW01M	LOCK WASHER 5MM
59	X1713059	6 AMP FUSE
60	X1713060	BLADE TENSION SPRING
61	X1713061	FLEXIBLE NECK GUARD
62	X1713062	MOTOR CORD
63	X1713063	FLEXIBLE NECK
64	X1713064	LAMP HOUSING
65	X1713065	LAMP
66	X1713066	BULB
67	X1713067	CORD CLAMP
68	XPS07M	PHLP HD SCR M4-.7 X 8
69	X1713069	BELLOWS
70	X1713070	BELLOWS LOCK
71	X1713071	PVC TUBE
72	X1713072	FORKED RETAINER
73	XPSB17M	CAP SCREW M4-.7 X 10
74	XPS05M	PHLP HD SCR M5-.8 X 8
75	X1713075	VARIABLE SPEED SWITCH
76	X1713076	THIN PROFILE HEX NUT 10MM
77	X1713077	BASE
78	XPCB13M	CARRIAGE BOLT M6-1 X 20
79	XPLW03M	LOCK WASHER 6MM
80	XPNO1M	HEX NUT M6-1
81	XPLW03M	LOCK WASHER 6MM
82	XPB08M	HEX BOLT M6-1 X 20
83	X1713083	STUD BOLT M6-1 X 95
84	XPNO1M	HEX NUT M6-1
85	X1713085	SPACER
86	X1713086	STUD BOLT HINGE PIN M6-1 X 18
87	XPS62M	PHLP HD SCR M6-1 X 30
88	X1713088	BLADE GUIDE SPACER

WARRANTY CARD

Name _____
Street _____
City _____ State _____ Zip _____
Phone Number _____ E-Mail _____ FAX _____
MODEL # _____ Serial # _____

The following information is given on a voluntary basis and is strictly confidential.

1. Where did you purchase your SHOP FOX® machine? _____
_____ Air Compressor _____ Panel Saw
_____ Band Saw _____ Planer
_____ Drill Press _____ Power Feeder
_____ Drum Sander _____ Radial Arm Saw
_____ Dust Collector _____ Machine
_____ Horizontal Boring Machine _____ Spindle Sander
_____ Scroll saw _____ Table Saw
_____ Machine _____ Vacuum Veneer Press
_____ Mortiser _____ Wide Belt Sander
_____ Other _____
2. How did you first learn about us?
_____ Advertisement _____ Friend
_____ Mail order Catalog _____ Local Store
_____ World Wide Web Site
_____ Other _____
3. Which of the following magazines do you subscribe to.
_____ American Woodworker _____ Today's Homeowner
_____ Cabinetmaker _____ Wood
_____ Family Handyman _____ Wooden Boat
_____ Fine Homebuilding _____ Woodshop News
_____ Fine Woodworking _____ Woodsmith
_____ Home Handyman _____ Woodwork
_____ Journal of Light Construction _____ Woodworker
_____ Old House Journal _____ Woodworker's Journal
_____ Popular Mechanics _____ Workbench
_____ Popular Science _____ American How-To
_____ Popular Woodworking
_____ Other _____
4. Which of the following woodworking/remodeling shows do you watch?
_____ Backyard America _____ The New Yankee Workshop
_____ Home Time _____ This Old House
_____ The American Woodworker _____ Woodwright's Shop
_____ Other _____
5. What is your annual household income?
_____ \$20,000-\$29,999 _____ \$60,000-\$69,999
_____ \$30,000-\$39,999 _____ \$70,000-\$79,999
_____ \$40,000-\$49,999 _____ \$80,000-\$89,999
_____ \$50,000-\$59,999 _____ \$90,000 +
6. What is your age group?
_____ 20-29 _____ 50-59
_____ 30-39 _____ 60-69
_____ 40-49 _____ 70 +
7. How long have you been a woodworker?
_____ 0 - 2 Years _____ 8 - 20 Years
_____ 2 - 8 Years _____ 20+ Years
8. How would you rank your woodworking skills?
_____ Simple _____ Advanced
_____ Intermediate _____ Master Craftsman
9. How many SHOP FOX® machines do you own? _____
10. What stationary woodworking tools do you own? Check all that apply.
_____ Air Compressor _____ Panel Saw
_____ Band Saw _____ Planer
_____ Drill Press _____ Power Feeder
_____ Drum Sander _____ Radial Arm Saw
_____ Dust Collector _____ Machine
_____ Horizontal Boring Machine _____ Spindle Sander
_____ Scroll saw _____ Table Saw
_____ Machine _____ Vacuum Veneer Press
_____ Mortiser _____ Wide Belt Sander
_____ Other _____
11. Which benchtop tools do you own? Check all that apply.
_____ 1" x 42" Belt Sander _____ 6" - 8" Grinder
_____ 5" - 8" Drill Press _____ Mini Machine
_____ 8" Table Saw _____ 10" - 12" Thickness Planer
_____ 8" - 10" Bandsaw _____ Scroll Saw
_____ Disc/Belt Sander _____ Spindle/Belt Sander
_____ Mini Scroll saw
_____ Other _____
12. Which portable/hand held power tools do you own? Check all that apply.
_____ Belt Sander _____ Orbital Sander
_____ Biscuit Joiner _____ Palm Sander
_____ Circular Saw _____ Portable Planer
_____ Detail Sander _____ Saber Saw
_____ Drill/Driver _____ Reciprocating Saw
_____ Miter Saw _____ Router
_____ Other _____
13. What machines/supplies would you like to see?

14. What new accessories would you like Woodstock International to carry?

15. Do you think your purchase represents good value?
_____ Yes _____ No
16. Would you recommend SHOP FOX® products to a friend?
_____ Yes _____ No
17. Comments: _____

CUT ALONG DOTTED LINE

FOLD ALONG DOTTED LINE

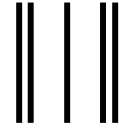
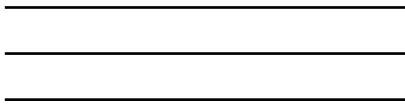

Place
Stamp
Here



WOODSTOCK INTERNATIONAL, INC.
P.O. BOX 2309
BELLINGHAM, WA 98227-2309



FOLD ALONG DOTTED LINE

TAPE ALONG EDGES--PLEASE DO NOT STAPLE

Free Manuals Download Website

<http://myh66.com>

<http://usermanuals.us>

<http://www.somanuals.com>

<http://www.4manuals.cc>

<http://www.manual-lib.com>

<http://www.404manual.com>

<http://www.luxmanual.com>

<http://aubethermostatmanual.com>

Golf course search by state

<http://golfingnear.com>

Email search by domain

<http://emailbydomain.com>

Auto manuals search

<http://auto.somanuals.com>

TV manuals search

<http://tv.somanuals.com>