

# *Grizzly* **Industrial, Inc.**®

## **10" HEAVY-DUTY TABLE SAW MODEL G1023Z, ZX & ZX3 INSTRUCTION MANUAL**



COPYRIGHT © NOVEMBER 2001 BY GRIZZLY INDUSTRIAL, INC  
**WARNING: NO PORTION OF THIS MANUAL MAY BE REPRODUCED IN ANY SHAPE  
OR FORM WITHOUT THE WRITTEN APPROVAL OF GRIZZLY INDUSTRIAL, INC.**  
REVISED NOVEMBER 2002, PRINTED IN TAIWAN

#### **ONLINE MANUAL DISCLAIMER**

THE INFORMATION IN THIS MANUAL REPRESENTS THE CONFIGURATION OF THE MACHINE AS IT IS CURRENTLY BEING SHIPPED. THE MACHINE CONFIGURATION CAN CHANGE AS PRODUCT IMPROVEMENTS ARE INCORPORATED. IF YOU OWN AN EARLIER VERSION OF THE MACHINE, THIS MANUAL MAY NOT EXACTLY DEPICT YOUR MACHINE. CONTACT CUSTOMER SERVICE IF YOU HAVE ANY QUESTIONS ABOUT DIFFERENCES. PREVIOUS VERSIONS ARE NOT AVAILABLE ONLINE.

# WARNING

Some dust created by power sanding, sawing, grinding, drilling, and other construction activities contains chemicals known to the State of California to cause cancer, birth defects or other reproductive harm. Some examples of these chemicals are:

- Lead from lead-based paints.
- Crystalline silica from bricks, cement, and other masonry products.
- Arsenic and chromium from chemically treated lumber.

Your risk from these exposures varies, depending on how often you do this type of work. To reduce your exposure to these chemicals: work in a well ventilated area, and work with approved safety equipment, such as those dust masks that are specially designed to filter out microscopic particles.

# TABLE OF CONTENTS

		PAGE
1.	<b>SAFETY</b>	
	SAFETY RULES FOR ALL TOOLS.....	2-3
	ADDITIONAL SAFETY INSTRUCTIONS FOR TABLE SAWS.....	4
	AVOIDING KICKBACK .....	5
	SAFETY ACCESSORIES .....	5-6
2.	<b>INTRODUCTION</b>	
	COMMENTARY .....	7
3.	<b>CIRCUIT REQUIREMENTS</b>	
	G1023Z .....	8
	G1023ZX .....	9
	G1023ZX3 .....	10
	GROUNDING .....	11
	EXTENSION CORDS .....	11
4.	<b>MACHINE FEATURES</b>	
	TERMS & DEFINITIONS .....	12-13
	MAIN FEATURES .....	13
5.	<b>SET UP</b>	
	UNPACKING .....	14
	PIECE INVENTORY .....	14-15
	HARDWARE RECOGNITION CHART .....	16
	CLEAN UP .....	17
	SITE CONSIDERATIONS.....	17
	BEGINNING ASSEMBLY .....	18
	EXTENSION WINGS .....	18-19
	FENCE & RAILS .....	19
	SWITCH .....	19
	DUST HOOD.....	20
	MOTOR COVER .....	20
	MOTOR BRACE .....	21
	GUARD BRACKET .....	21
	HANDWHEEL .....	22
	TABLE INSERT.....	22
	SAW BLADE .....	23
	BLADE GUARD/SPLITTER .....	23-25
	MITER GAUGE .....	26
	START UP.....	27
	RECOMMENDED ADJUSTMENTS .....	27
6.	<b>OPERATIONS</b>	
	BLADE SELECTION .....	28-29
	CROSSCUTTING .....	30
	RIPPING .....	31
	DADO OPERATIONS .....	32-34
	RABBET OPERATIONS .....	34-37
7.	<b>MAINTENANCE</b>	
	GENERAL .....	38
	LUBRICATION .....	39
	TABLES.....	39
	V-BELT.....	39-40
	MAINTENANCE LOG .....	41
8.	<b>SERVICE AGREEMENT</b>	
	45° & 90° STOPS .....	42
	BLADE PARALLELISM .....	43-44
	BLADE ALIGNMENT .....	45-46
	WIRING DIAGRAM .....	47-49
9.	<b>CLOSURE</b> .....	50
	DATA SHEET .....	51
	PARTS BREAKDOWNS & LIST.....	52-54
	TROUBLESHOOTING.....	55
	PUSH STICK PATTERN .....	57
	WARRANTY AND RETURNS .....	58-60

# SECTION 1: SAFETY

## WARNING

### For Your Own Safety Read Instruction Manual Before Operating This Equipment

The purpose of safety symbols is to attract your attention to possible hazardous conditions. This manual uses a series of symbols and signal words which are intended to convey the level of importance of the safety messages. The progression of symbols is described below. Remember that safety messages by themselves do not eliminate danger and are not a substitute for proper accident prevention measures.



Indicates an imminently hazardous situation which, if not avoided, **WILL** result in death or serious injury.



Indicates a potentially hazardous situation which, if not avoided, **COULD** result in death or serious injury.



Indicates a potentially hazardous situation which, if not avoided, **MAY** result in minor or moderate injury, or **MAY** cause property damage.

## NOTICE

This symbol is used to alert the user to useful information about proper operation of the equipment.

## WARNING

### Safety Instructions For Power Tools

- KEEP GUARDS IN PLACE** and in working order.
- REMOVE ADJUSTING KEYS AND WRENCHES.** Form habit of checking to see that keys and adjusting wrenches are removed from tool before turning on.
- KEEP WORK AREA CLEAN.** Cluttered areas and benches invite accidents.
- DO NOT USE IN DANGEROUS ENVIRONMENT.** Do not use power tools in damp or wet locations, or where any flammable or noxious fumes may exist. Keep work area well lighted.
- KEEP CHILDREN AND VISITORS AWAY.** All children and visitors should be kept at a safe distance from work area.
- MAKE WORKSHOP CHILD PROOF** with padlocks, master switches, or by removing starter keys.
- DO NOT FORCE TOOL.** It will do the job better and safer at the rate for which it was designed.
- USE RIGHT TOOL.** Do not force tool or attachment to do a job for which it was not designed.

# WARNING

## Safety Instructions For Power Tools

- 9. USE PROPER EXTENSION CORD.** Make sure your extension cord is in good condition. Conductor size must be in accordance with the chart below. The amperage rating is listed on the motor or tool nameplate. An undersized cord will cause a drop in line voltage resulting in loss of power and overheating. Your extension cord must also contain a ground wire and plug pin. Always repair or replace damaged extension cords.

Minimum Gauge for Extension Cords

AMP RATING	LENGTH		
	25ft	50ft	100ft
0-6	16	16	16
7-10	16	16	14
11-12	16	16	14
13-16	14	12	12
17-20	12	12	10
21-30	10	10	No

- 10. WEAR PROPER APPAREL.** Do not wear loose clothing, gloves, neckties, rings, bracelets, or other jewelry which may get caught in moving parts. Non-slip footwear is recommended. Wear protective hair covering to contain long hair.
- 11. ALWAYS USE ANSI-APPROVED SAFETY GLASSES.** Also use face or dust mask if cutting operation is dusty. Everyday eyeglasses only have impact resistant lenses, they are NOT safety glasses.
- 12. SECURE WORK.** Use clamps or a vise to hold work when practical. It is safer than using your hand and frees both hands to operate tool.
- 13. NEVER OVERREACH.** Keep proper footing and balance at all times.
- 14. MAINTAIN TOOLS WITH CARE.** Keep tools sharp and clean for best and safest performance. Follow instructions for lubricating and changing accessories.
- 15. DISCONNECT TOOLS** before servicing and changing accessories, such as blades, bits, cutters, and any other item.
- 16. REDUCE THE RISK OF UNINTENTIONAL STARTING.** Make sure switch is in off position before plugging in. Also, the magnetic switch on this machine may start if the switch gets bumped hard enough.
- 17. USE RECOMMENDED ACCESSORIES.** Consult the owner's manual for recommended accessories. The use of improper accessories may cause risk of injury.
- 18. CHECK DAMAGED PARTS.** Before further use of the tool, a guard or other part that is damaged should be carefully checked to determine that it will operate properly and perform its intended function. Check for alignment of moving parts, binding of moving parts, breakage of parts, mounting, and any other conditions that may affect its operation. A guard or other part that is damaged must be properly repaired or replaced.
- 19. NEVER LEAVE TOOL RUNNING UNATTENDED. TURN POWER OFF.** Do not leave tool until it comes to a complete stop.
- 20. NEVER USE UNDER THE INFLUENCE** of alcohol or drugs, or when tired.
- 21. IF AT ANY TIME YOU ARE EXPERIENCING DIFFICULTIES** performing the intended operation, stop using the machine! Then contact our service department or ask a qualified expert how the operation should be performed.

## WARNING

# Additional Safety Instructions For Table Saws

1. **THRU-SAWING:** Use blade guard, splitter, and anti-kickback fingers on all thru-sawing operations. See **Page 12** for the definition of thru-sawing.
2. **KICKBACK:** Use anti-kickback devices during ALL cutting operations. If you do not have a complete understanding of how kickback occurs, or how to prevent it, Do not operate this table saw. See **Page 12** for the definition of kickback.
3. **DANGEROUS REACHING:** Do not reach behind or over the saw blade with either hand while the saw is running.
4. **PUSHSTICK:** Use a push stick when ripping narrow stock.
5. **FREE-HAND CUTTING:** The fence or the miter gauge must support the workpiece during all cutting operations.
6. **BODY POSITION WHEN CUTTING:** Do not stand or have any part of your body in-line with the path of the saw blade.
7. **WORKPIECE CONTROL:** Hold the workpiece firmly against the miter gauge or fence and hold the workpiece firmly against the table.
8. **CROSSCUTTING:** Move the rip fence out of the way when crosscutting.
9. **MITER GAUGE/RIP FENCE:** Never use the miter gauge and rip fence at the same time.
10. **STALLED BLADE:** Never attempt to free a stalled saw blade without first turning the saw off.
11. **CUTOFF TABLES:** Use adequate support to the rear and sides of the saw table for wide or long workpieces.
12. **HAND SAFETY:** Avoid awkward cutting operations and hand positions where a sudden slip could cause your hand to move into the saw blade.
13. **SAW BLADE:** Lower the saw blade below the table when not in use.
14. **DAMAGED SAW BLADE:** Never use a damaged saw blade or one that has been dropped.
15. **DADO CUTTING:** There is a high degree of risk involved with any dado operation. See **Page 12** for the definition of dado.

## WARNING

Unfamiliarity with this manual could result in serious personal injury. Become familiar with the contents of this manual, including all the safety warnings.

## WARNING

No list of safety guidelines can be complete. Operating this machinery may require additional safety precautions specific to your shop environment. Failure to use reasonable caution while operating this machine could result in serious personal injury.

# Avoiding Kickback

## **!WARNING**

Failure to understand how and why kickback occurs could cause serious personal injury. **DO NOT** operate this table saw if you do not have a clear understanding of kickback, and how it occurs.

Statistics prove that most common accidents among table saw users can be linked to kickback.

Kickback is typically defined as the high-speed expulsion of stock from the table saw toward its operator.

In addition to the danger of the operator or others in the area being struck by the flying stock, it is often the case that the operator's hands are forced into the blade during the kickback.

### The following can help minimize kickbacks:

- Use your blade guard and splitter.
- Never for any reason place your hand behind the blade. Should kickback occur, your hand will be pulled into the blade.
- Inspect splitter for alignment between it and your blade.
- Never use the fence as a guide for crosscutting.
- Never attempt freehand cuts.
- Use a push stick or featherboard to maintain control of your workpiece.
- Feed cuts through to completion.
- Stand to the side when ripping.
- Ensure your fence and miter slot are parallel to the blade.

If you do not have a clear understanding of kickback and how it occurs, do not operate this table saw.



# Safety Accessories

## **!WARNING**

Not using safety accessories could cause serious personal injury. Learn how to correctly use each safety accessory.

### Push Sticks

The use of push sticks, particularly when cutting small or narrow workpieces, provides a double benefit for saw operators. The push stick provides added leverage, enabling the operator to keep the workpiece firmly supported against the fence and table. At the same time, the push stick keeps the operator's hand safely away from the rotation of the saw blade as shown in **Figure 1**. See the template on **Page 57** of the manual for construction details, or purchase one from the Grizzly catalog or website.



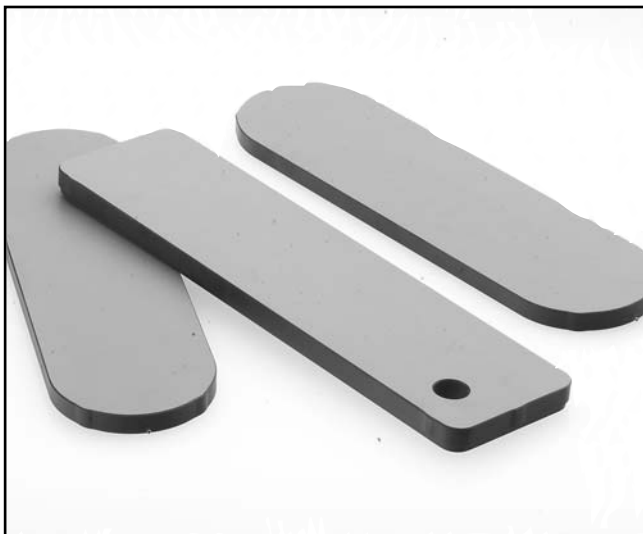
**Figure 1.** Push Stick.

### Zero Clearance Table Inserts

Ideal for use when ripping thin strips or making bevel cuts, these prevent tearout and jammed blades by supporting material close to the blade.

Use the standard table insert as a template when creating additional inserts from wood or plywood. Slots can be custom cut for specific blade angles by raising the running blade into an uncut insert at the angle you desire. Be sure to make an additional slot for the blade splitter.

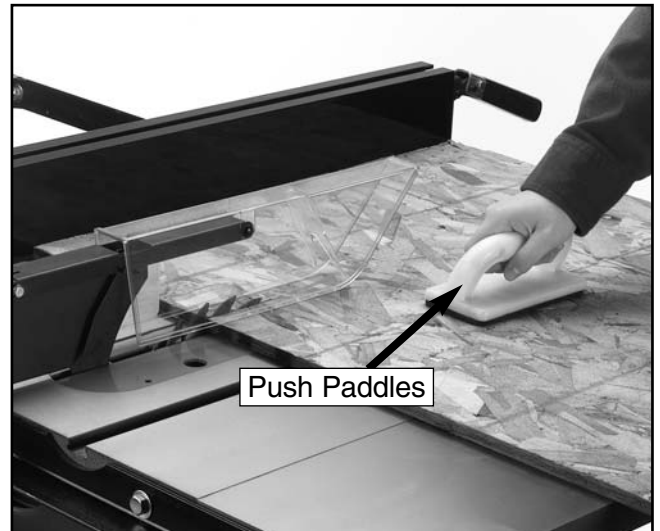
We also carry a wide selection of table inserts (**Figure 2**) in the Grizzly catalog or website. Be sure to hold the insert firmly in place with a piece of wood when creating slots. Never hold the table insert with your hand while cutting new slots.



**Figure 2.** Zero Clearance Table Inserts.

### Push Paddles

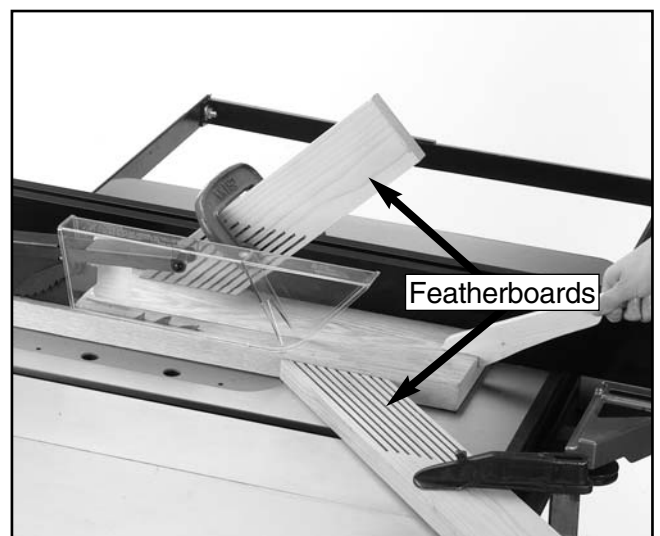
Push paddles provide added leverage and support when ripping or crosscutting wide workpieces as shown in **Figure 3**. We offer a number of push paddles in the Grizzly catalog.



**Figure 3.** Push Paddles.

### Featherboards

Easily made from scrap stock, featherboards provide an added degree of protection against kick-back as shown in **Figure 4**. To make a featherboard, cut a 30-40° angle at one end of the board and make a number of end cuts at approximately 1/4" apart and 2" to 3" deep. We also offer a number of featherboards in the Grizzly catalog.



**Figure 4.** Featherboards.





# SECTION 2: INTRODUCTION

## Commentary

We are proud to offer the Grizzly Model G1023Z Series Table Saw. The Model G1023Z Series is part of a growing Grizzly family of fine wood-working machinery. When used according to the guidelines set forth in this manual, you can expect years of trouble-free, enjoyable operation and proof of Grizzly's commitment to customer satisfaction.

The Model G1023Z Series is an industrial grade table saw intended for professional use. Features include cast iron trunnions, triple V-belt drive, magnetic switch, and the Shop Fox® Fence. The G1023Z features a 3 HP 220V single-phase motor and the Model G1023ZX features a 5 HP 220V single-phase motor. The Model G1023ZX3 makes the step up to a 5 HP 220V 3-phase motor.

Grizzly offers many accessories for the table saws including blades, extension rails, outfeed rollers and mobile bases. Please refer to the current Grizzly catalog or website for prices and ordering information.

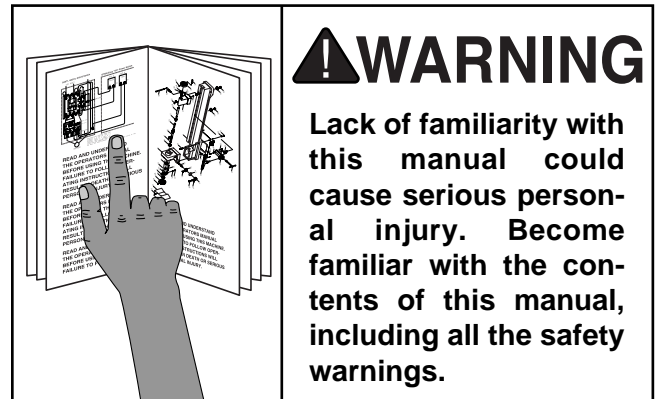
Grizzly is also pleased to provide this manual with the Model G1022 Series Table Saws. It was written to guide you through assembly, review safety considerations, and cover general operating procedures. If you have any comments regarding this manual, please write to us at the address below:

Grizzly Industrial, Inc.  
c/o Technical Documentation  
P.O. Box 2069  
Bellingham, WA 98227-2069

Most importantly, we stand behind our machines. If you have any service questions or parts requests, please call or write us at the location listed below:

Grizzly Industrial, Inc.  
1203 Lycoming Mall Circle  
Muncy, PA 17756  
Phone: (570) 546-9663  
Fax: (800) 438-5901  
E-Mail: [techsupport@grizzly.com](mailto:techsupport@grizzly.com)  
Web Site: <http://www.grizzly.com>

The specifications, drawings, and photographs illustrated in this manual represent the Model G1023Z Series Table Saws as supplied when the manual was prepared. However, owing to Grizzly's policy of continuous improvement, changes may be made at any time with no obligation on the part of Grizzly. Current Grizzly machine manuals can be viewed and printed at: [www.grizzly.com](http://www.grizzly.com).



# SECTION 3: CIRCUIT REQUIREMENTS

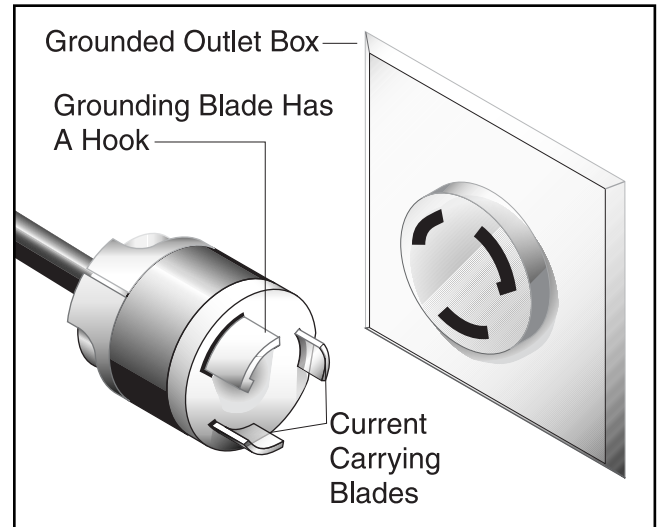
## G1023Z

### **⚠️ WARNING**

If the machine is not wired correctly a fire could result. Make sure your wiring, receptacle, plug, and circuit breaker can handle the current draw of the machine. If you are not sure that your electrical circuit can handle the current draw, get a qualified electrician to test your electrical system and do any required upgrades. **DO NOT** attempt to modify an existing circuit by only replacing the circuit breaker with one rated for a higher amperage draw than the wiring, receptacle, and plug are rated for.

The motor supplied with the Model Z is a 3 HP 220V single-phase motor. Under normal 220V use, the motor draws approximately 18 amps. Use a 20 amp circuit breaker or a 20 amp slow-blow fuse for 220V operation.

The Model Z does not come with a plug. When operating at 220V, use a NEMA-style L6-20 plug and receptacle as shown in **Figure 5**.



**Figure 5.** NEMA-style L6-20 plug and outlet.

The circuit you use should be dedicated, (i.e., the machine should provide the only draw from that circuit). If frequent circuit failures occur when using this machine, contact our Service Department or your local electrical contractor.



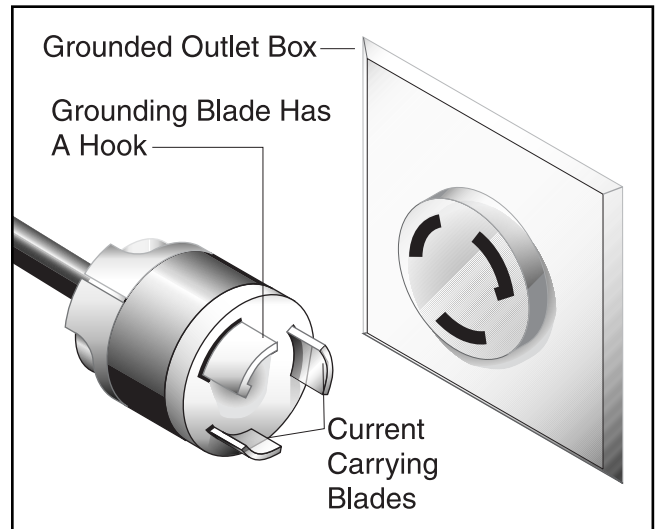
# G1023ZX

## **⚠️ WARNING**

If the machine is not wired correctly a fire could result. Make sure your wiring, receptacle, plug, and circuit breaker can handle the current draw of the machine. If you are not sure that your electrical circuit can handle the current draw, get a qualified electrician to test your electrical system and do any required upgrades. **DO NOT** attempt to modify an existing circuit by only replacing the circuit breaker with one rated for a higher amperage draw than the wiring, receptacle, and plug are rated for.

The motor supplied with the Model ZX is a 5 HP 220V single-phase motor. Under normal 220V use, the motor draws approximately 25 amps. Use a 30 amp circuit breaker or a 30 amp slow-blow fuse for 220V operation.

The Model ZX does not come with a plug. When operating at 220V, use a NEMA-style L6-30 plug and receptacle as shown in **Figure 6**.



**Figure 6.** NEMA-style L6-30 plug and outlet.

The circuit you use should be dedicated, (i.e., the machine should provide the only draw from that circuit). If frequent circuit failures occur when using this machine, contact our Service Department or your local electrical contractor.



# G1023ZX3

---

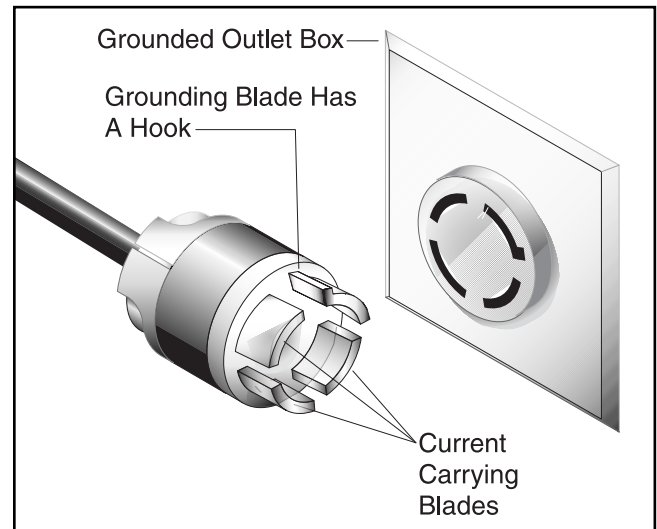
---

## **⚠️ WARNING**

If the machine is not wired correctly a fire could result. Make sure your wiring, receptacle, plug, and circuit breaker can handle the current draw of the machine. If you are not sure that your electrical circuit can handle the current draw, get a qualified electrician to test your electrical system and do any required upgrades. **DO NOT** attempt to modify an existing circuit by only replacing the circuit breaker with one rated for a higher amperage draw than the wiring, receptacle, and plug are rated for.

The motor supplied with the Model ZX3 is a 5 HP 220V 3-phase motor. Under normal 220V use, the motor draws approximately 15 amps. Use a 20 amp circuit breaker or a 20 amp slow-blow fuse for 220V operation.

The Model ZX3 does not come with a plug. When operating at 220V, use a NEMA-style L15-20 plug and receptacle as shown in **Figure 7**.

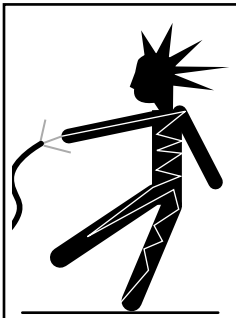


**Figure 7.** NEMA-style L15-20 plug and outlet.

The circuit you use should be dedicated, (i.e., the machine should provide the only draw from that circuit). If frequent circuit failures occur when using this machine, contact our Service Department or your local electrical contractor.



# Grounding



## **⚠️ WARNING**

Electrocution or a fire can result if the band-saw is not grounded correctly. Make sure all electrical circuits are grounded. Do not use the machine if it is not grounded.

## **NOTICE**

The wire on the power cord with green or green and yellow striped insulation is the grounding conductor.

In the event of an electrical short, grounding provides electric current a path of least resistance to reduce the risk of electrical shock to the operator. Ground the power cord and this machine in accordance with all local codes and ordinances.

Operating this machine when it is not properly grounded can result in electric shock or electrocution.



# Extension Cord

Should it be necessary to use an extension make sure the cord is rated Hard Service (grade S) or better. Refer to the chart in *Section 1: Safety Instructions* to determine the minimum gauge for the extension cord. The extension cord must also contain a ground wire and plug pin. Always repair or replace extension cords when they become worn or damaged.



## **⚠️ CAUTION**

No single list of electrical guidelines can be comprehensive for all shop environments. Operating this machinery may require additional electrical upgrades specific to your machine and shop environment. It is your responsibility to make sure your electrical systems comply with all local electrical codes and ordinances.

# SECTION 4: MACHINE FEATURES

---

## Terms & Definitions

---

The following is a list of common definitions, terms and phrases used throughout this manual as they relate to this table saw and woodworking in general. It is important that you read and become familiar with them before assembling, adjusting or operating this machine. Your safety is **VERY** important to us at Grizzly!

**Arbor:** Metal shaft extending from the drive mechanism, to which the cutting blade is attached.

**Bevel Edge Cut:** Tilting the saw arbor and blade to an angle between 0° and 45° to perform an angled cutting operation.

**Blade Guard:** Metal or plastic mechanism that mounts over the saw blade to prevent accidental contact with the cutting edge.

**Crosscut:** Table saw operation in which the miter gauge is used to cut across the grain of a piece of wood.

**Dado Blade:** Blade or set of blades that attach to the arbor and are used for cutting grooves and rabbets.

**Dado Cut:** Table saw operation that uses a dado blade to cut a flat bottomed groove into the face of wood stock.

**Featherboard:** Safety device used to keep the workpiece against the rip fence or table during a cutting operation. The featherboard also allows the operator to keep his/her hands at a safe distance away from the saw blade while cutting the workpiece.

**Kerf:** The resulting cut or gap made by a saw blade.

**Kickback:** A condition in which the wood is thrown back towards an operator at a high rate of speed.

**Miter Gauge:** A component that controls the wood stock movement while performing a crosscut. Allows for variation of angle cuts such as miter cuts used on a picture frame.

**Moulding Head:** A cutterhead attached to the arbor that accepts interchangeable moulding knives for profile cutting. We **DO NOT** recommend the use of moulding head cutters.

**Parallel:** Being an equal distance apart at every point. i.e. the rip fence face is parallel to the side face of the saw blade.

**Non-Thru Cut:** A sawing operation that requires the removal of the blade guard and splitter. Dado and rabbet cuts are considered Non-Thru Cuts because the blade does not protrude above the top face of the wood stock. Always remember to reinstall the blade guard and splitter after performing a non-thru cut.

**Perpendicular:** Intersecting and forming right angles; at right angles to the vertical and horizontal planes. i.e. the blade is perpendicular to the table surface.

**Push Paddle:** Safety aid used to push a piece of wood stock through a cutting operation.

**Push Stick:** Safety aid used to push a piece of wood stock through a cutting operation. Usually used when rip cutting.

**Rabbet:** Cutting operation that creates an L-shaped channel along the edge of wood stock.

**Splitter:** Metal plate attached to the back of the blade guard that maintains the kerf opening in the wood when performing a cutting operation.

**Standard Kerf:**  $\frac{1}{8}$ " gap made with a standard blade.

**Straightedge:** A tool used to check the flatness, parallelness, or consistency of a surface(s).

**Thru-Sawing:** A sawing operation where the wood stock thickness is completely sawn through. Proper blade height usually allows  $\frac{1}{4}$ " of the top of the blade to extend above the wood stock.

**Thin Kerf:**  $\frac{3}{32}$ " gap made with a thin kerf blade.

**Rip Cut:** A cut made along the grain of the wood.

**Sacrificial Fence:** A piece of wood attached to the face of the rip fence that is designed to extend the fence face away from the metal portion of the fence. Used primarily when making rabbet cuts with a dado blade.



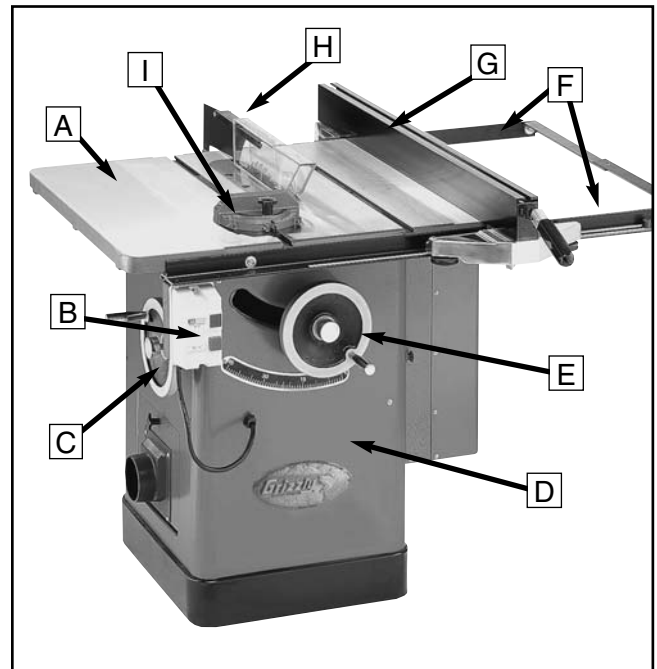
---

---

## Main Features

Set up and operation instructions will be easier to understand if you become familiar with the location and names of the basic features.

Match up the feature list below with the letters in **Figure 8** to identify the table saw feature locations.



**Figure 8.** The front of the table saw.

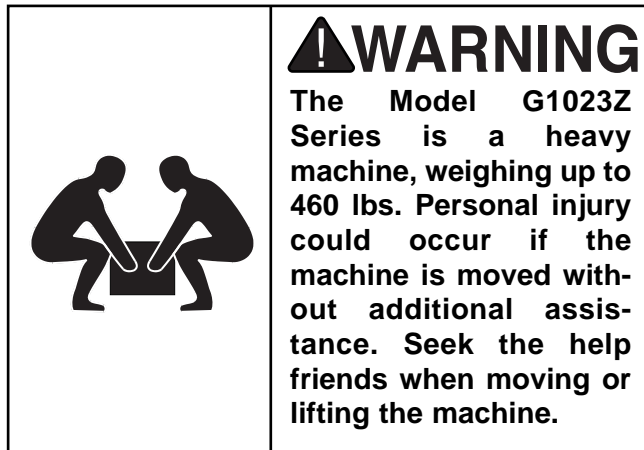
- A. Extension Wing
- B. On/Off Switch
- C. Blade Height Handwheel
- D. Base
- E. Blade Angle Handwheel
- F. Rip Fence Rails
- G. Rip Fence
- H. Blade Guard/Splitter Assembly
- I. Miter Gauge



# SECTION 5: SET UP

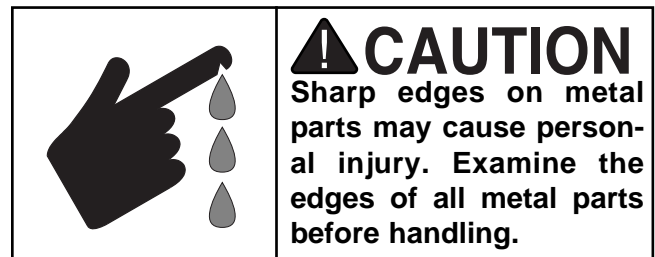
## Unpacking

The Model G1023Z Series Table Saws are shipped from the manufacturer in three carefully packed boxes. If you discover the machine is damaged after you have signed for delivery, immediately call our Customer Service for advice.



## Piece Inventory

When you are completely satisfied with the condition of your shipment of boxes, you should inventory their parts.



Box 1:



Figure 9A. Shop Fox® fence components.

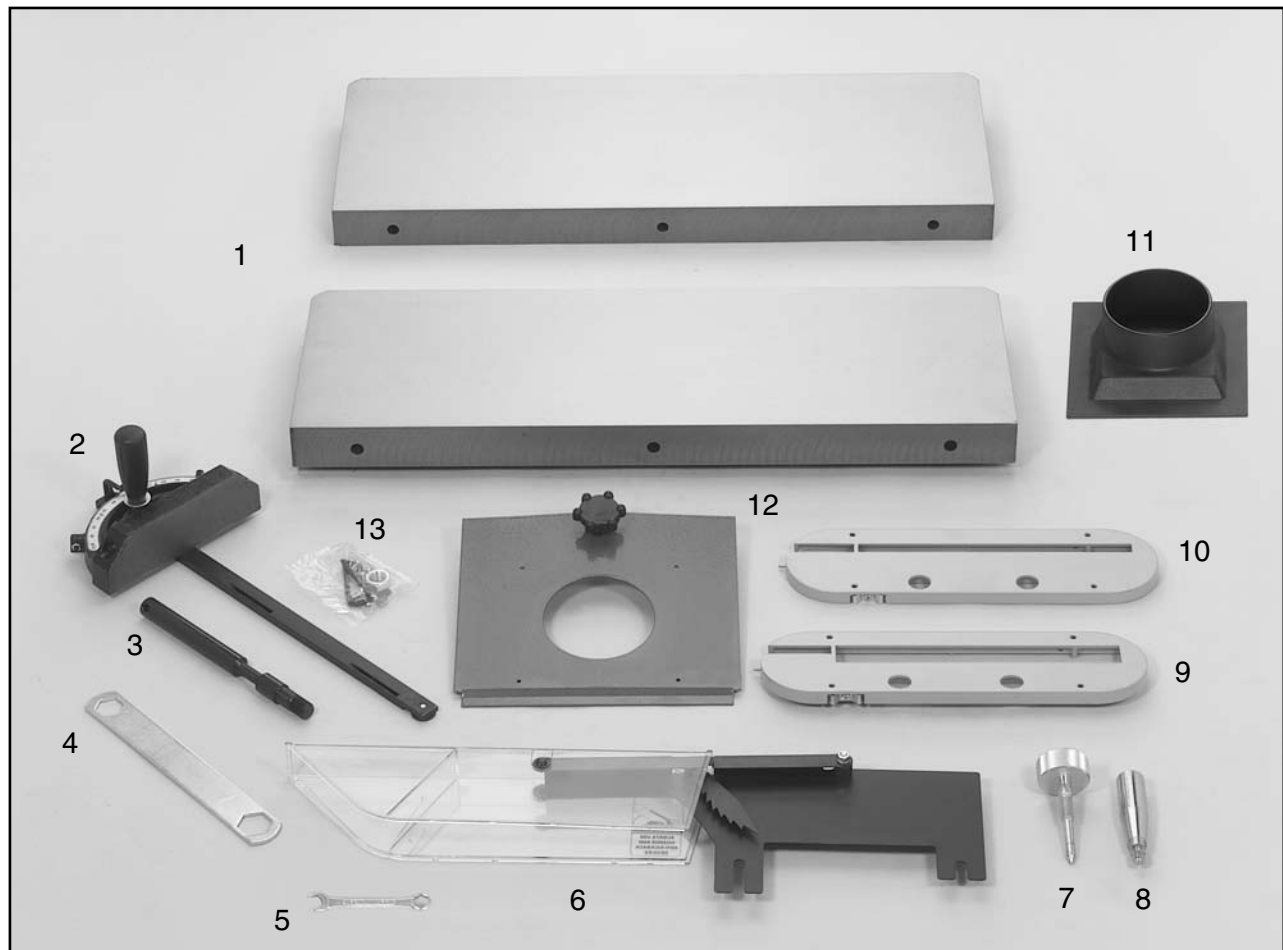
Box 2:



Figure 9B. Motor cover assembly.



**Box 3:**



**Figure 9C.** G1023Z Series component layout.

**After all the parts have been removed from Box 3, you should have:**

1. Extension Wings (2)
2. Miter Gauge
3.  $\frac{5}{8}$ "-18 Blade Guard Mounting Shaft
4. Arbor Wrench
5.  $\frac{5}{8}$ " Combo Wrench
6. Blade Guard Assembly
7. Handwheel Knob Bolt
8. Handwheel Handle
9. Dado Blade Table Insert
10. Standard Blade Table Insert
11. Dust Port
12. Cleanout Door
13. Hardware Bag
14. Table Saw Unit (Not Shown)

**The hardware bag should contain the following:**

- (1) 3mm Allen Wrench
- (1) 4mm Allen Wrench
- (1) Combo Wrench  $\frac{5}{8}$ "
- (1)  $\frac{5}{8}$ "-18 Blade Guard Mounting Shaft
- (1)  $\frac{5}{8}$ "-18 Hex Nut
- (4) #8 x  $\frac{3}{8}$ " Self Tapping Screw
- (4) #8 Flat Washer
- (2)  $\frac{1}{4}$ "-20 x  $\frac{3}{8}$ " Phillip Head Screw
- (2)  $\frac{1}{4}$ " Lock Washer



# Hardware Recognition Chart

Use this chart to match up hardware pieces during the assembly process!

MEASURE BOLT DIAMETER BY PLACING INSIDE CIRCLE

#10

1/4"

5/16"

3/8"

7/16"

1/2"

5/8"

4mm

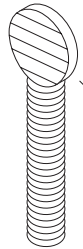
6mm

8mm

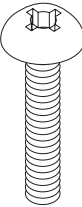
10mm

12mm

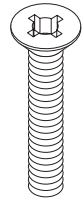
16mm



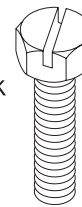
Thumb Screw



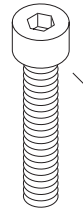
Phillips Head Screw



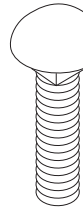
Countersunk Phillips Head Screw



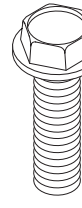
Slotted Screw



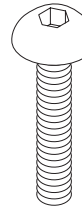
Cap Screw



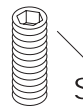
Carriage Bolt



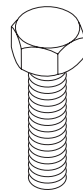
Flange Bolt



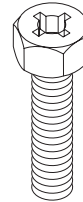
Button Head Screw



Setscrew



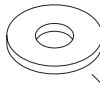
Hex Head Bolt



Phillips Head Hex Bolt



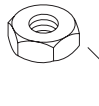
Phillips Head Sheet Metal Screw



Washer



Lock Washer



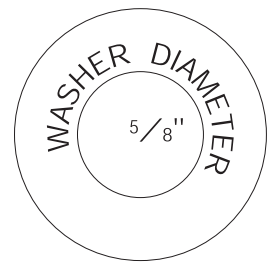
Hex Nut



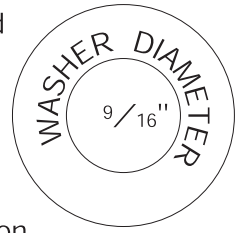
Lock Nut



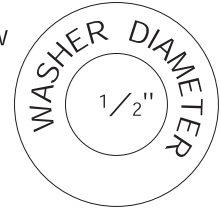
Wing Nut



WASHER DIAMETER  
5/8"



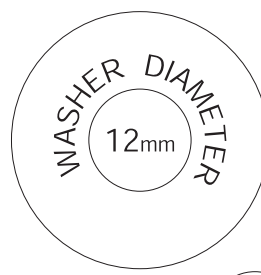
WASHER DIAMETER  
9/16"



WASHER DIAMETER  
1/2"



WASHER DIAMETER  
7/16"



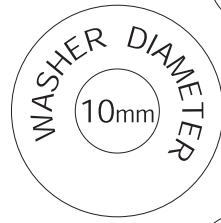
WASHER DIAMETER  
12mm



WASHER DIAMETER  
3/8"



WASHER DIAMETER  
4mm



WASHER DIAMETER  
10mm



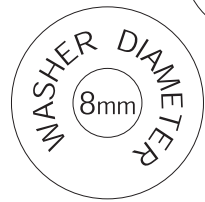
WASHER DIAMETER  
5/16"



WASHER DIAMETER  
6mm



WASHER DIAMETER  
1/4"

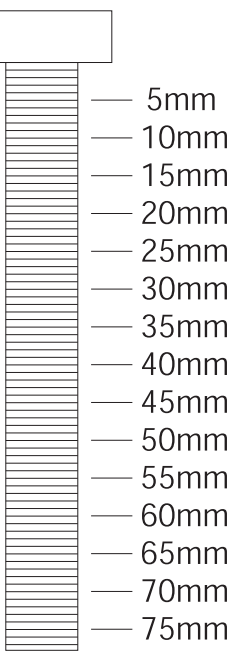


WASHER DIAMETER  
8mm

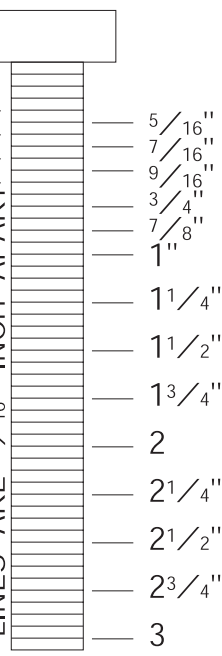


WASHER DIAMETER  
#10

LINES ARE 1MM APART




LINES ARE 1/16" APART




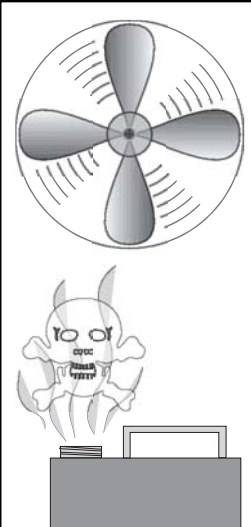
WASHERS ARE MEASURED BY THE INSIDE DIAMETER

# Clean Up

The unpainted surfaces are coated with a waxy oil to protect them from corrosion during shipment. Remove this waxy oil with a solvent cleaner or citrus-based degreaser such as Grizzly's G7895 Degreaser. To clean thoroughly, some parts may need to be removed. **The machine will operate best when the waxy oil is removed from all moving and sliding parts.** Chlorine-based cleaners and solvents will damage the painted surfaces of the machine. Follow the manufacturer's instructions when using any type of cleaning product.

	<b>!WARNING</b> Gasoline or petroleum products used to clean the machinery could explode causing serious personal injury. <b>DO NOT</b> use gasoline or petroleum products to clean the machinery.
--	---

	<b>!WARNING</b> Smoking near solvents could ignite an explosion or fire causing serious injury. <b>DO NOT</b> smoke while using solvents.
---	--

	<b>!WARNING</b> Lack of ventilation while using solvents could cause serious personal health risks, fire, or environmental hazards. Always work in a well ventilated areas to prevent the accumulation of dangerous fumes. Supply the work area with a constant supply of fresh air using a fan.
---	---

# Site Considerations

## Floor Load

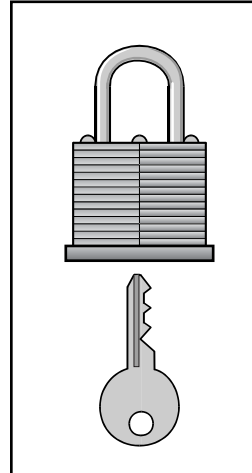
The Model G1023Z Series Table Saws are a heavy load with a medium footprint. Most commercial or home shop floors should be sufficient to carry the weight of the machine. Reinforce the floor if you question its ability to support the weight.

## Working Clearance

Working clearances can be thought of as the distances between machines and obstacles that allow safe operation of every machine without limitation. Consider existing and anticipated machine needs, size of material to be processed through each machine, and space for auxiliary stands or work tables. Also, consider the relative position of each machine to one another for efficient material handling. Be sure to allow yourself sufficient room to safely run your machines in any foreseeable operation and keep dust collection hoses off the floor and out of the way.

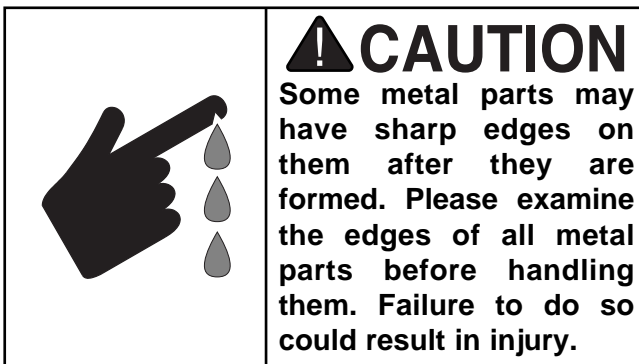
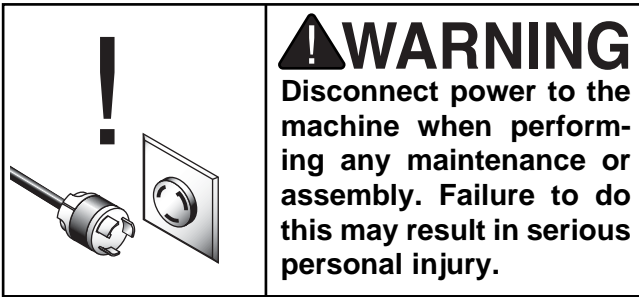
## Lighting

Lighting should be bright enough to eliminate shadows and prevent eye strain. Electrical circuits should be dedicated or large enough to handle combined motor amp loads. Be sure to follow local electrical codes for proper installation of new lighting or circuits.

	<b>!WARNING</b> Unsupervised children and visitors entering a shop could receive serious personal injury. Ensure child and visitors safety by keeping all entrances to the shop locked at all times. <b>DO NOT</b> allow unsupervised children or visitors in the shop at any time.
--	--



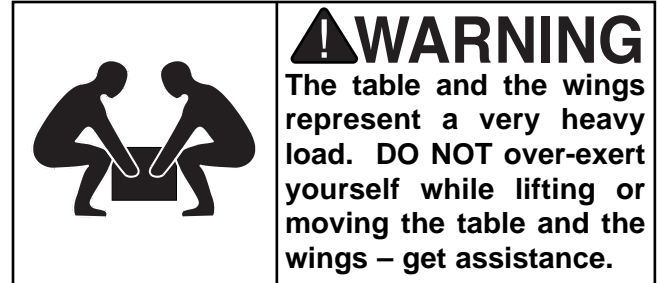
# Beginning Assembly



**TOOLS REQUIRED:** You will need a high quality square, a long straightedge, 10mm, 12mm, 14mm open end wrenches and a 3mm Allen® wrench.



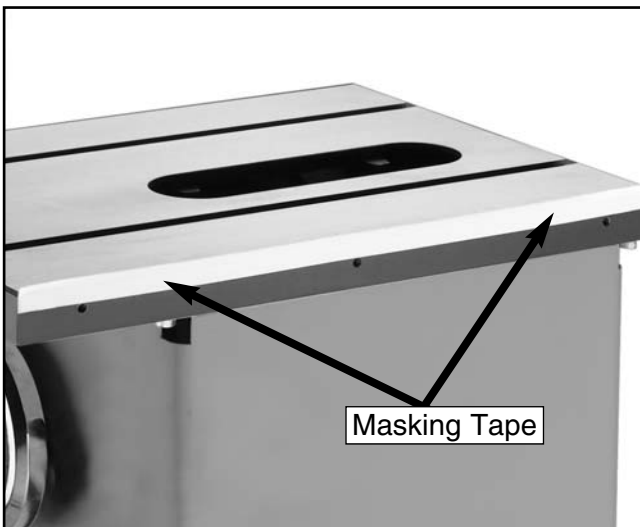
# Extension Wings



To attach the extension wings to the saw:

1. Attach the left wing to the table using the (3)  $\frac{3}{8}$ "-16 x 1 $\frac{1}{4}$ " Hex Bolts and  $\frac{3}{8}$ " Flat Washers provided. Adjust the wing reasonably flush with the table and do not tighten the bolts completely at this time.
2. Attach the right wing to the table using the (3)  $\frac{3}{8}$ "-16 x 1 $\frac{1}{4}$ " Hex Bolts and  $\frac{3}{8}$ " Flat Washers provided. Adjust the wing reasonably flush with the table and do not tighten the bolts completely at this time.
3. Align the top of the wings flush with the table top directly above the front bolts and flush with the front edge of the table. Tighten the front bolts.
4. Raise or lower the rear of the extension wings until the middle of the wings are flush with the table top. Tighten the middle bolts.
5. Raise or lower the rear of the wings until the wings and table are flush. Tighten the rear bolts.
6. Re-check the flushness of the wings against the table above each bolt. Re-adjust if necessary.

7. Check the alignment of the table and both wings with a straightedge. The straightedge should run flat across both wings and the table top. If the straightedge contacts both wings and the table evenly, you are finished with this section. If the straightedge does not contact them evenly, continue to **Step 9**.
8. If the extension wings tilt up or down at the outside edges, remove the wings and shim them with masking tape as shown in **Figure 10**.
  - A) If a wing tilts down, stick layers of masking tape along the bottom edge of the table and retighten.
  - B) If a wing tilts up, stick layers of masking tape along the top edge of the wing and retighten. *Allow the tape to extend above table surface and trim the extended tape with a sharp knife after final assembly.*
9. Re-check the alignment of the table and both wings with a straightedge and re-adjust if necessary.



**Figure 10.** Using tape to shim for wing alignment.

## Fence & Rails

Your Model G1023Z Series comes with a Shop Fox® Brand Fence & Rails. Refer to the manual included in the fence box for assembly instructions.



## Switch

The switch comes prewired to the motor and can be easily mounted to the rail.

### To mount the switch:

1. Line the switch bracket holes up with the holes on the underside of the rail.
2. Secure the switch and bracket to the underside of the rail using the (2) ¼"-20 x ⅜" Phillip Head Screws and ¼" Lock Washers.
3. **Disconnect the machine from the power source!**
4. Connect the plug on the cord between the switch and motor.



---

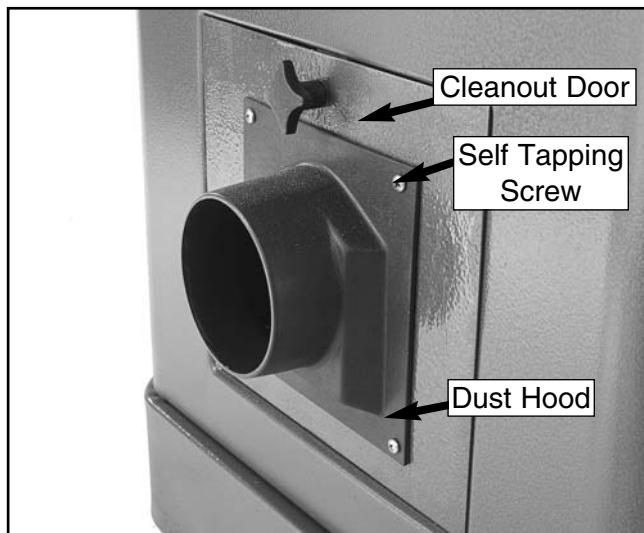
---

## Dust Hood

The Model G1023Z Series comes with a 4" dust hood and a cleanout door.

### To mount the dust hood and cleanout door:

1. Mount the cleanout door into the square hole on the lower left side of the saw base.
2. Using (4) #8 x  $\frac{3}{8}$ " Self Tapping Screws and #8 Flat Washer, screw the dust hood to the cleanout door.
3. Be sure to orient the dust hood so the 4" flange is on the lower half of the dust hood when installed as shown in **Figure 11**.



**Figure 11.** Installing dust hood.

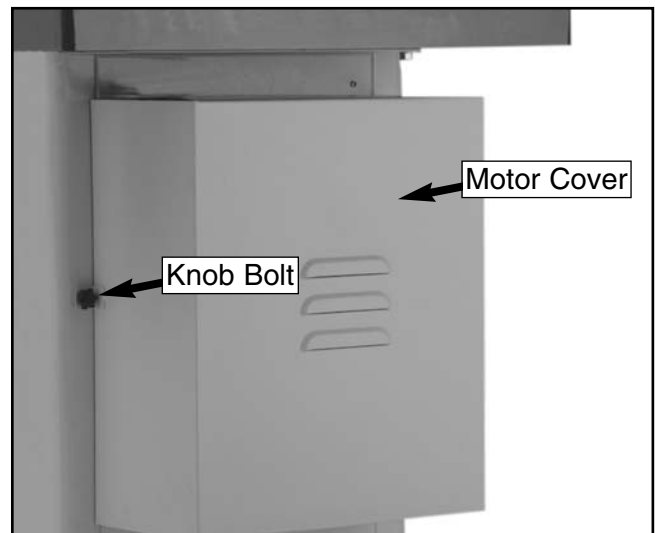


---

---

## Motor Cover

The Model G1023Z Series motor cover is designed to increase the efficiency of dust collection. The motor cover is packaged and shipped in a separate box. It is held shut by a  $\frac{1}{4}$ "-20 x  $\frac{1}{2}$ " knob bolt as shown in **Figure 12a**.



**Figure 12a.** Installed motor cover.



# Motor Brace

A red motor brace has been installed for shipping purposes. Remove this brace before continuing with assembly. The bolts that secure the brace should be screwed back in at the locations from which they came.



Figure 12b. Motor brace.



# Guard Bracket

## NOTICE

The blade guard mounting bracket (Figure 13) is supplied with the Shop Fox® Fence.

To install the blade guard assembly:

1. Thread the  $\frac{5}{8}$ "-18 blade guard mounting shaft into the mounting location on the back of the table saw base as shown in **Figure 13**.
2. Secure the blade guard mounting shaft with the included  $\frac{5}{16}$ "-18 hex bolt.
3. Slide the loosely assembled bracket onto the blade guard mounting shaft and temporarily hand tighten the nuts as shown in **Figure 14**.

G1023Z Series Heavy-Duty 10" Table Saw



Figure 13. Attaching the  $\frac{5}{8}$ "-18 blade guard mounting shaft.

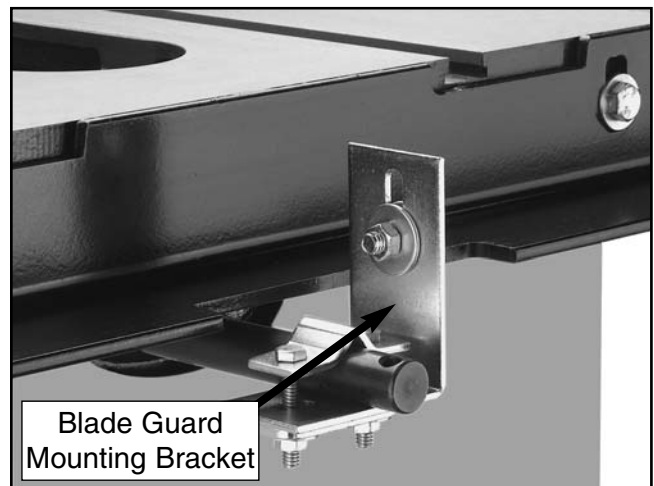


Figure 14. Blade guard mounting bracket



---

---

# Handwheel

---

---

One handwheel has been removed for shipping. To install, place the handwheel over the threads and screw the lock knob into the center. Next insert the handle into the handwheel and tighten it as shown in **Figure 15**. Install the other handle onto the other handwheel.



**Figure 15.** Tightening handle onto handwheel.



---

---

# Table Insert

---

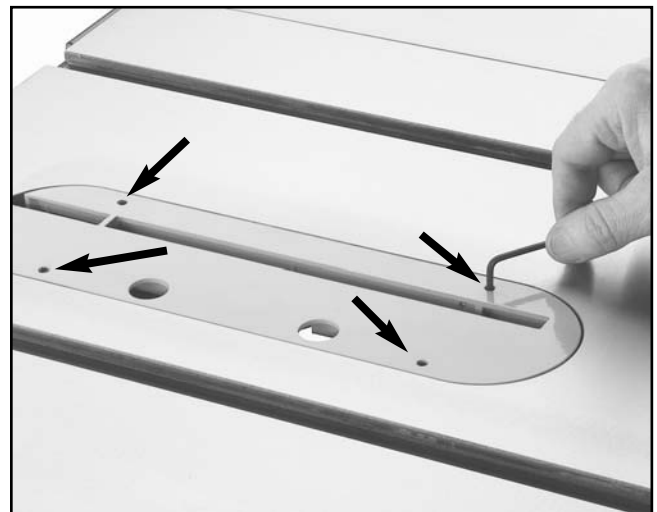
---

The table insert provides support for the material being cut. It must be installed flush with the cast iron table surface.

## To install the table insert:

1. **Disconnect the machine from the power source!**
2. Using the front handwheel, move the blade to its lowest position.

3. Set the table insert into the recessed area on the table surface.
4. Ensure that all four table insert setscrews (**Figure 16**) are firmly in contact with the table casting.
5. Using an allen wrench, raise or lower each of the four setscrews until the insert is flush with the table top.
6. Using the side handwheel, position the blade 90° to the table surface.
7. Wearing leather gloves, rotate the blade while raising and lowering it through its full range of motion. Make sure it never contacts any part of the table insert.
8. Repeat **Step 6** with the blade in the 45° position.



**Figure 16.** Setscrews on each corner of insert.

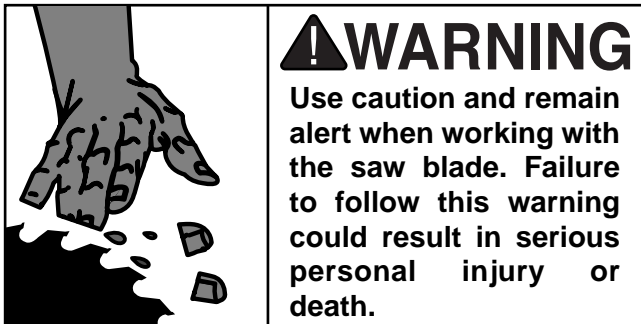




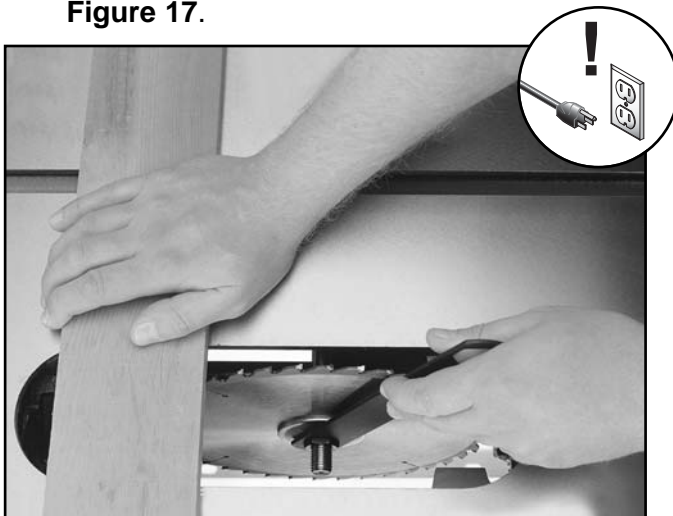
# Saw Blade

To install a saw blade:

1. **Disconnect the machine from the power source!**
2. **The arbor nut has left-hand threads.** Loosen the arbor nut clockwise and remove the outside flange from the arbor. Remove and discard the  $\frac{3}{4}$ " diameter spacer on the arbor shaft.



3. Install the saw blade onto the arbor. Ensure that the blade teeth point toward you as you stand at the front of the saw.
4. Slide on the flange and thread the arbor nut back on.
5. Use the arbor wrench provided with the saw to tighten the arbor nut. Wedge a block of wood in the teeth of the blade to keep it from turning when tightening the nut as shown in **Figure 17**.



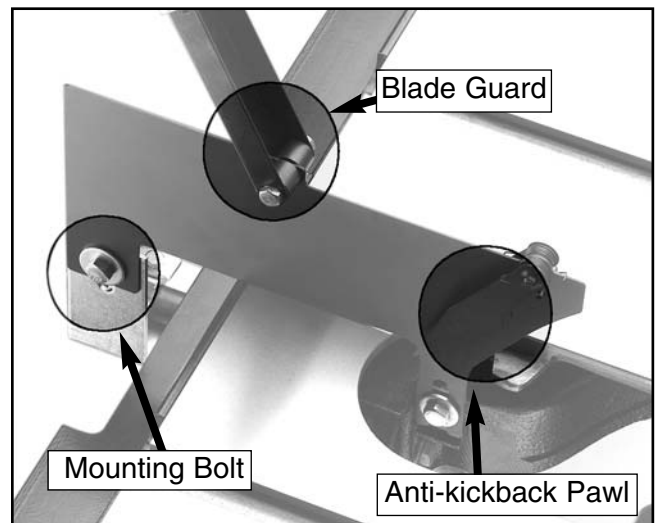
**Figure 17.** Changing saw blade.



# Blade Guard/Splitter

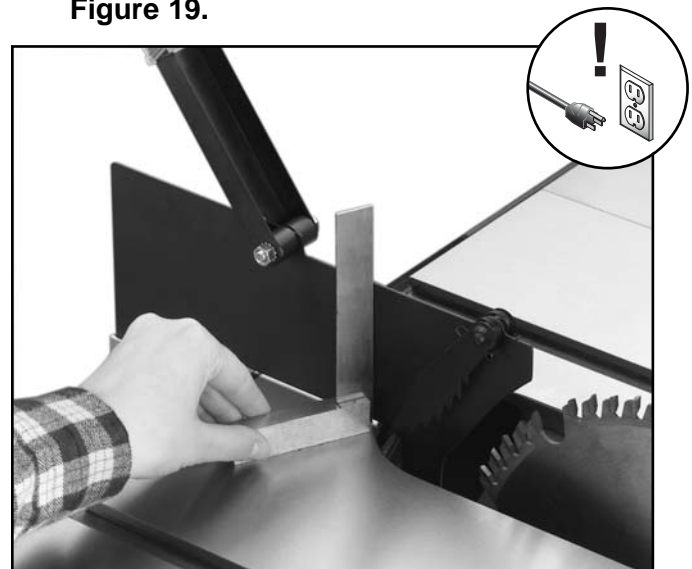
To install a blade guard/splitter:

1. **Disconnect the machine from the power source!**
2. Slip the blade guard/splitter over the mounting bolts as shown in **Figure 18**. The washers should be between the bolt head and the slots. Tighten the bolts to secure the blade guard/splitter.

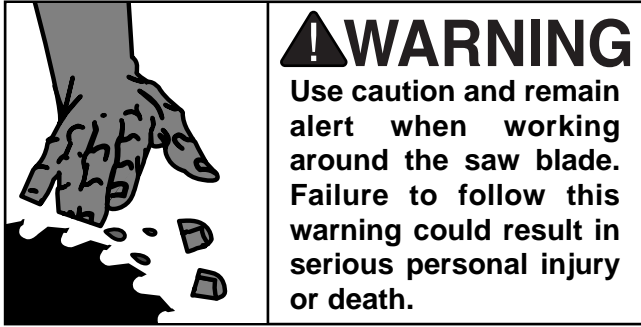


**Figure 18.** Blade guard and splitter in place.

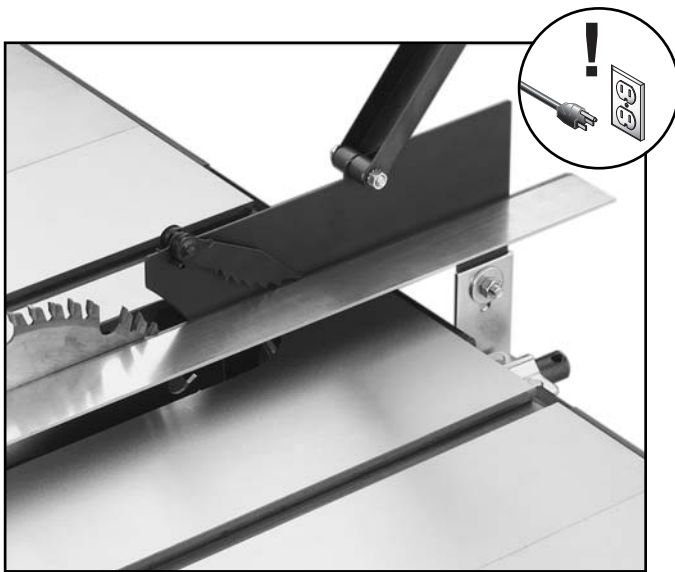
3. Set a machinist's square against the face of the blade splitter. Slightly rotate the rear bracket to adjust the face of the blade splitter perpendicular to the table top as shown in **Figure 19**.



**Figure 19.** Blade splitter square to table.

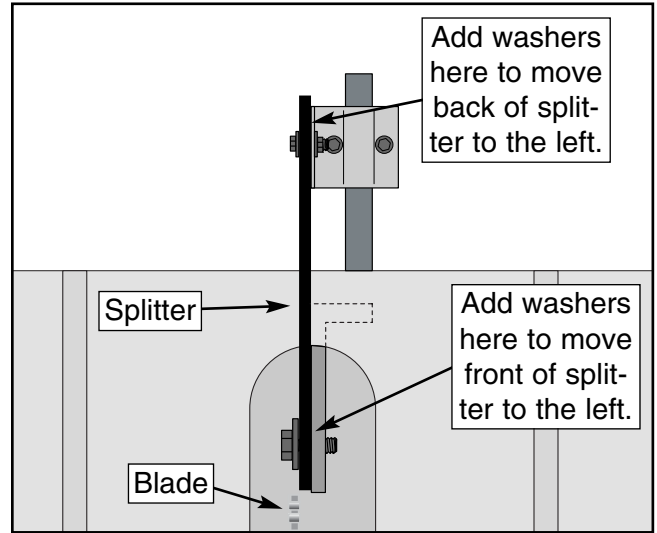


- Next, set a straightedge against the face of the saw blade and the blade splitter as shown in **Figure 20**. If the blade splitter is properly aligned, please skip ahead to **Page 26**; otherwise, continue with the next step.

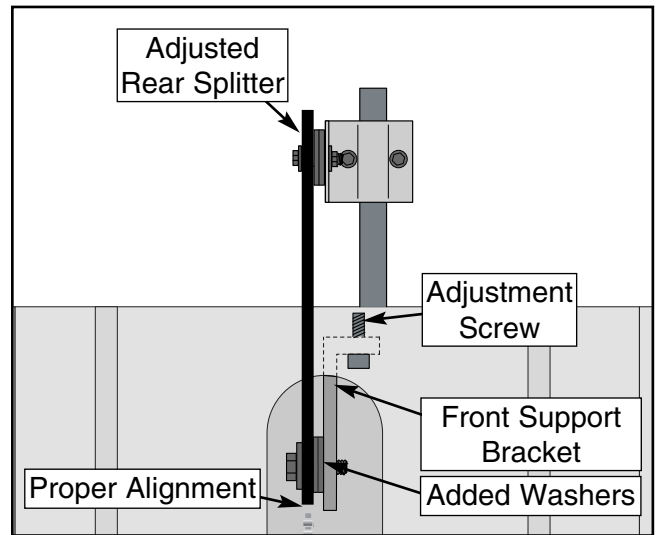


**Figure 20.** Guard in line with blade.

- If the blade splitter is to the right of the blade as shown in **Figure 21**, simply add washers between the splitter and the front mounting bracket, and adjust the rear splitter support as shown in **Figure 22**.



**Figure 21.** Improper splitter/blade alignment.



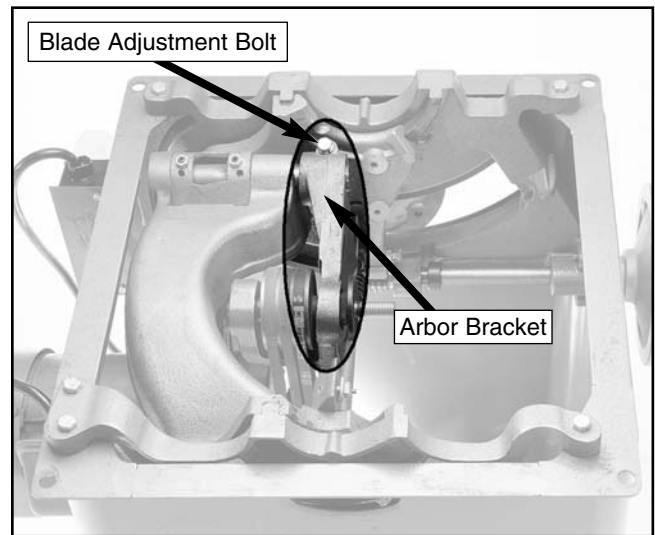
**Figure 22.** Proper splitter/blade alignment.

6. Recheck the splitter alignment to the blade and to the table top. Adjust as necessary and tighten all the bolts before use. If the blade guard is properly aligned, please skip ahead to **Step 13**; otherwise, continue with the next step.
7. If the splitter is positioned to the left of the blade, alignment cannot be achieved by washer placement. Adjustment of the front support bracket is required. See **Figure 21** for adjustment details. Loosen the 2 adjustment screws and move left or right.
8. If this adjustment does not allow enough movement of the splitter, remove the table and wings, and set them to one side. *Be sure to note the position of the table shims. Replace them to their original position before re-attaching the table.*



**The arbor bracket and motor pulley now need to be adjusted:**

9. Loosen the adjustment bolt shown in **Figure 23**, and slowly slide the arbor bracket towards the end of the shaft. *Only move the arbor bracket a distance equal to the amount of misalignment between the blade and the splitter, or a little more. You can always adjust the splitter back to the left with washers.*
10. Tighten the adjustment bolt securely.



**Figure 23.** Arbor bracket adjustment locations.

11. Moving the arbor bracket moves the V-belts and pulleys out of alignment, so adjustment of the motor pulley is required. Simply loosen the setscrew in the middle groove of the pulley, and slowly slide the pulley toward the end of the motor shaft. Once the V-belts are back in alignment, tighten the setscrew securely.
12. Recheck the guard alignment to the blade and to the table top. Adjust as necessary and tighten down all the bolts before use. If the blade guard is properly aligned, re-attach the table, making sure there is adequate blade clearance through all blade adjustments.
13. Adjust the blade to 45°. Raise and lower it through the full range. Re-adjust the blade to 90°, then raise and lower it through the full range. There should be no contact between the blade, the base, the table insert, or any other part of the saw. If there is contact, repeat **Steps 8-12**.



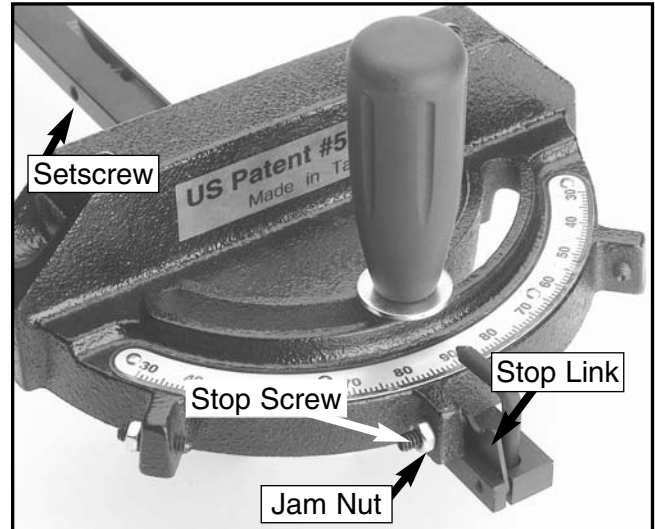
# Miter Gauge

The miter gauge for the Model G1023Z Series has two setscrews in the miter bar which can be set to remove any loose movement between the miter bar and the T-slot.

## To adjust the miter gauge:

1. Loosen or tighten the two miter bar setscrews (**Figure 23**) until the miter gauge slides freely in the slot, but has no loose movement.
2. Loosen the lock knob on the miter gauge and place a square against the face of the miter body and the miter bar.
3. Adjust the miter body until there is no space between the square and the miter bar.
4. Tighten the lock knob.
5. With the stop link (**Figure 23**) in the up position, loosen the jam nut and adjust the stop screw until it is seated against the stop link.
6. Loosen the setscrew on the left front side of the miter bar, adjust the pointer to 90° and retighten the setscrew.

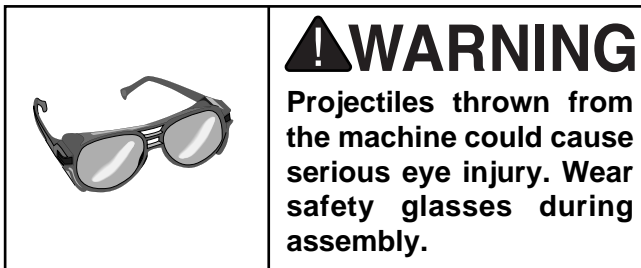
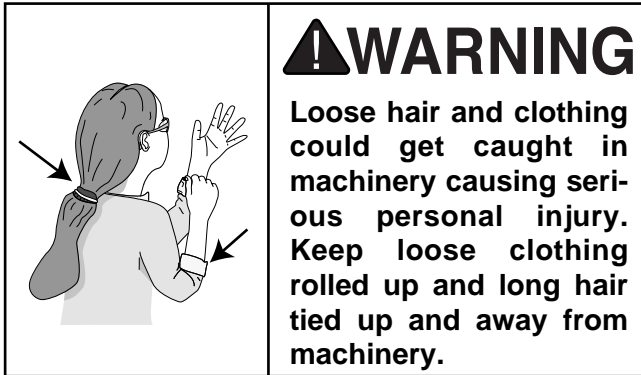
7. To adjust to 45°, follow **Steps 1-6** while using an adjustable square.
8. After rotating the miter body from 45° to 90° and back a few times, double check your adjustments at both angles to ensure that you have accurately set your miter gauge.



**Figure 23.** Miter gauge adjustment points.



# Start Up



## Before starting the machine:

1. Read this manual and make sure you take all safety precautions before operating this machine.
2. Make sure the blade guard and splitter have been correctly installed and are adjusted properly as shown on **Pages 23-25**.
3. Make sure that any tools or foreign objects have been removed from the machine.
4. Review *Section 3: Circuit Requirements* beginning on **Page 8** and make sure all wiring is correct.
5. Keep your finger on the *STOP* button during the entire test run of the machine.

## Starting the machine:

Turn the machine on and make sure your hand is on the *STOP* button in case you need to shut the machine off immediately. The machine should run smoothly with little or no vibration.



# Recommended Adjustments

For your convenience, the adjustments listed below have been performed at the factory and no further setup is required to operate your machine.

However, because of the many variables involved with shipping, we recommend that you at least check the following adjustments to ensure the best possible results from your new machine.

All of these adjustments are covered in step-by-step detail in *Section 8: Service Adjustments*.

## Recommended adjustment checklist:

- 45° & 90° Stops (**Page 39**)
- Blade Parallelism (**Page 40**)
- Blade Alignment (**Page 42**)



# SECTION 6: OPERATIONS

## WARNING

Wear safety glasses, a dust mask, and hearing protection while the machine is running. Failure to do this could result in serious personal injury.



## Blade Selection

Choosing the correct blade for the job is essential for the safe and efficient use of your table saw.

**Rip Blade:** Used for cutting with the grain. 10" rip blades have between 20-40 teeth (Figure 25), flat-top ground tooth profile (Figure 30) and large gullets to allow for large chip removal.



Figure 25. Ripping blade.

**Cross-cut Blade:** Used for cutting across the grain. 10" cross-cut blades have between 60-80 teeth (Figure 26), alternate top bevel or steep alternate top bevel tooth profiles (Figure 30), small hook angle and a shallow gullet.



Figure 26. Crosscutting blade.

**Combination Blade:** Used for cutting with and across the grain. A compromise between a rip blade and a cross-cut blade, a 10" combination blade will typically have between 40-50 teeth (Figure 27), an alternate top bevel and flat or alternate top bevel (Figure 30) and raker tooth profile. The teeth are arranged in groups of five. The gullets are small and shallow within the groups of five teeth, similar to a cross-cut blade; then large and deep between the groups, like a ripping blade.



Figure 27. Combination blade.

**Plywood Blade:** Used for cutting plywood or veneers. 10" plywood blades have 40-80 teeth (Figure 28), a steep alternate top bevel tooth profile (Figure 30) and very shallow gullet.



Figure 28. Plywood blade.

**Thin-kerf:** Designed for saws with smaller motors and for reducing material waste, thin-kerf blades are thinner than standard blades. Performance and accuracy can be maintained by the use of blade stabilizers.

## ⚠ WARNING

Some blade guards/splitters are thicker than thin-kerf blades. DO NOT use the thin-kerf blade if this is the case or serious personal injury could result.

**Dado Blades:** There are two types of dado blades: stacked and wobble.

- **Stacked Dado Blade**—These dedicated dado cutting blades consist of a set of up to 8 individual blades. Multiple cutters are "stacked" between two outside blades. The width of the dado is determined by the combination of cutters that are "stacked" together. The dado is cut in a single pass leaving a smooth and square channel in the face of the workpiece as shown on Page 32. Stacked dado blades are the most expensive option but are worth considering if your projects require a lot of visible dado cuts. A typical stacked dado blade is shown in Figure 29.

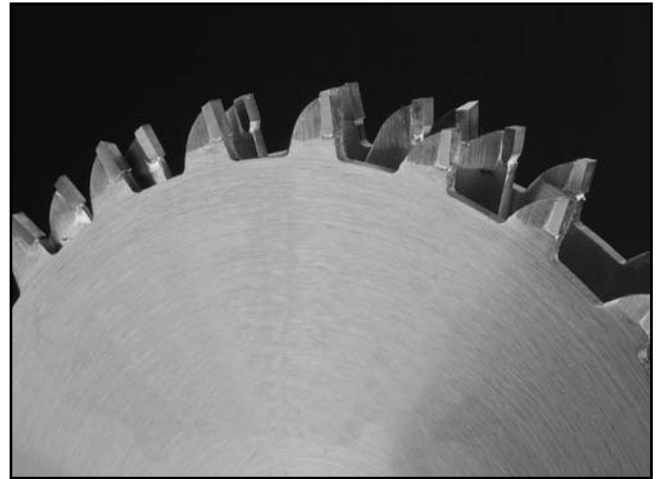


Figure 29. Optional dado blade.

- **Wobble Dado Blade**—Also a dedicated dado blade, a wobble blade usually consists of a single blade that is tilted on the arbor shaft while it is spinning. The channel is cut in the face of the workpiece as the blade passes through its pre-adjusted width of travel. Wobble blades are an inexpensive option when visibly pleasing channels are not a concern.

**Moulding Heads:** A moulding head is a cutter-head that attaches to the arbor and holds individual moulding knives. They should only be used by professional woodworkers with training beyond the scope of this manual.

This section on blade selection is by no means comprehensive. Always follow the saw blade manufacturer's recommendations to ensure safe and efficient operation of your table saw.

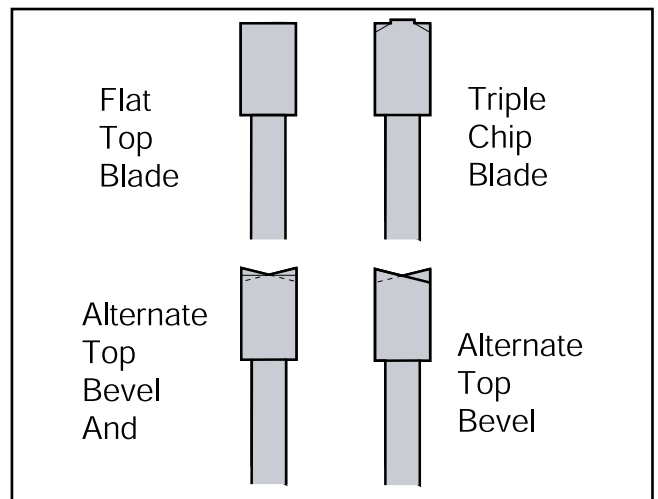
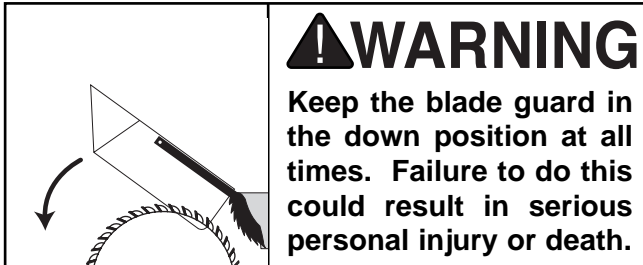


Figure 30. Various saw tooth cutting profiles.



# Crosscutting

A crosscut is a cut against the grain direction of the workpiece. Crosscutting man-made wood products like plywood is performed by cutting parallel to the shortest side.



**To make a 90° crosscut using the miter gauge:**

1. Adjust the miter gauge to the 90° position.
  2. Adjust the fence completely away from the cutting operation.
  3. Position the miter gauge in one of the two miter slots.
  4. Adjust the blade height so the highest saw tooth protrudes approximately ¼" above the workpiece.
  5. Hold the workpiece against the miter gauge and line up the cut with the blade.
6. Turn on the saw and allow it to come to full speed.
  7. Hold the workpiece firmly against the face of the miter gauge and ease it into the blade as shown in **Figure 31**.

## **!WARNING**

Turn off the saw and allow the blade to come to a complete stop before removing the cut-off piece. Failure to follow this warning could result in serious personal injury



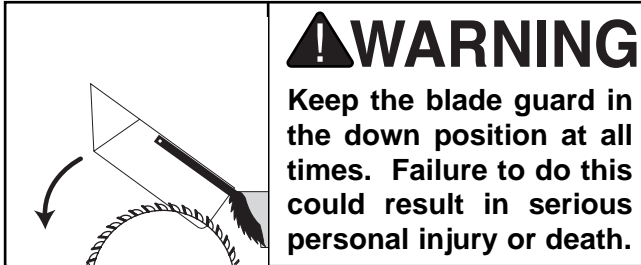
**Figure 31.** Cross-cut operation.





# Ripping

A rip cut is a cut with the grain direction of the workpiece. Ripping man-made wood products like plywood is performed by cutting parallel to the longest side.



## To make a rip cut:

1. Set the fence to the desired width of cut on the fence rail scale.
2. Adjust the blade height so the highest saw tooth protrudes approximately  $\frac{1}{4}$ " above the workpiece.
3. Joint one long edge of the workpiece on a jointer.
4. Set up any safety devices such as featherboards or other anti-kickback devices.
5. **With the saw disconnected from the power source**, rotate the blade to make sure it does not come into contact with any of the safety devices.
6. Plug the saw into the power source, and turn on the saw and allow it to come to full speed.
7. The jointed edge of the workpiece must be slide against the fence during the cutting operation.

## **!WARNING**

Stand to the left of the blade line-of-cut when ripping a board. Serious personal injury could occur if kickback results.

8. Using a push stick, feed the workpiece through the saw blade as shown in **Figure 32**, until the workpiece is completely past the saw blade. *When a small width is to be ripped and a push stick cannot be safely put between the blade and rip fence, rip a larger piece to obtain the desired piece.*

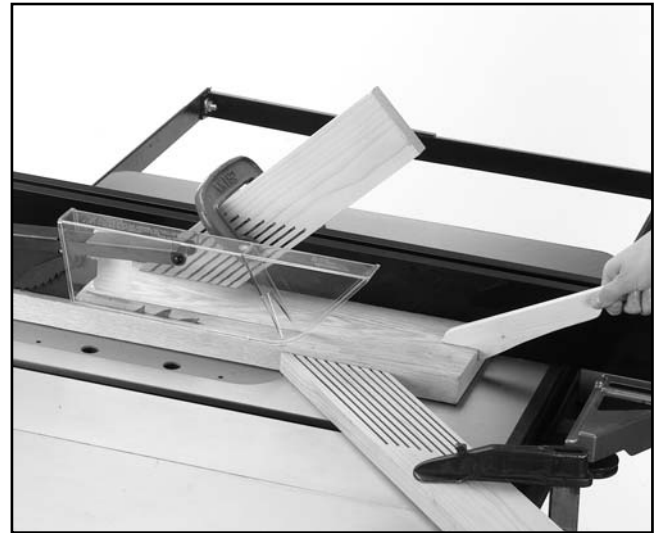


Figure 32. Ripping operation.

## **!WARNING**

Turn off the saw and allow the blade to come to a complete stop before removing the cut-off piece. Failure to follow this warning could result in serious personal injury



# Dado Cutting

Commonly used in furniture joinery, a dado is a straight channel cut in the face of the workpiece. Dadoes can be cut using either a dado blade (Figure 57) or a standard saw blade.

## **!WARNING**

Dado operations present very real hazards requiring proper procedures to avoid serious injury. The chance of kickback is always greater when dado blades are used so extra care must be taken. Any movement of the stock away from the fence will cause kickback. Be certain that stock is flat and straight. Failure to follow these warnings could result in serious personal injury.

To use a stacked or wobble dado blade:

1. Disconnect the machine from the power source!
2. Remove the table insert, splitter guard, and regular saw blade.
3. Attach and adjust the dado blade system as recommended in the dado blade manufacturer's instructions.
4. Install the dado table insert.
5. Raise the dado blade up to the desired depth of cut (depth of dado channel desired).

## **!WARNING**

Never perform a through cut operation with a dado blade. A dado blade was designed to make non-through cuts only. Failure to follow this warning could result in serious personal injury.

6. If dadoing along the long length of your workpiece, adjust the distance between the fence and the inside edge of the blade to suit your needs as shown in Figure 33.

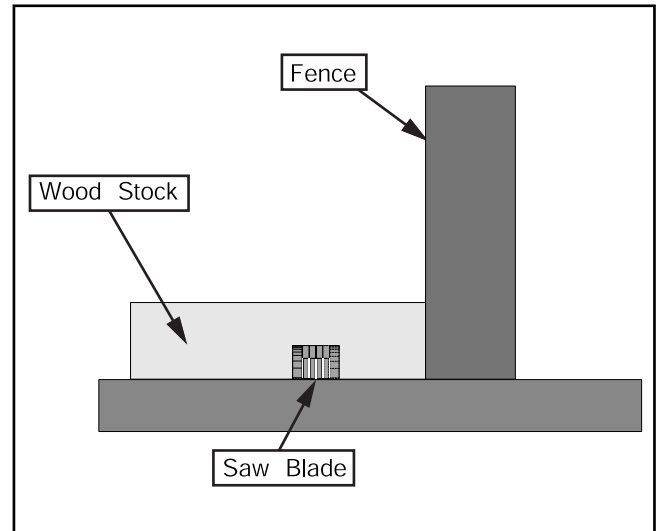


Figure 33. Single-blade dado cut.

## **!WARNING**

Never allow hands or arms to be above or behind the saw blade. Should kickback occur, the hands and arms could be pulled into the saw blade causing serious personal injury.

## **!WARNING**

Always use push sticks, featherboards, push paddles and other safety accessories whenever possible to increase safety and control during operations which require the blade guard and splitter to be removed from the saw. Failure to follow this warning could result in serious personal injury.

7. Reconnect the saw to the power source.
8. With one finger ready to push the *OFF* button, turn the saw on. The blade should run smooth with no vibrations or wobbling.
9. When the blade has reached full speed, perform a test cut with a scrap piece of wood.

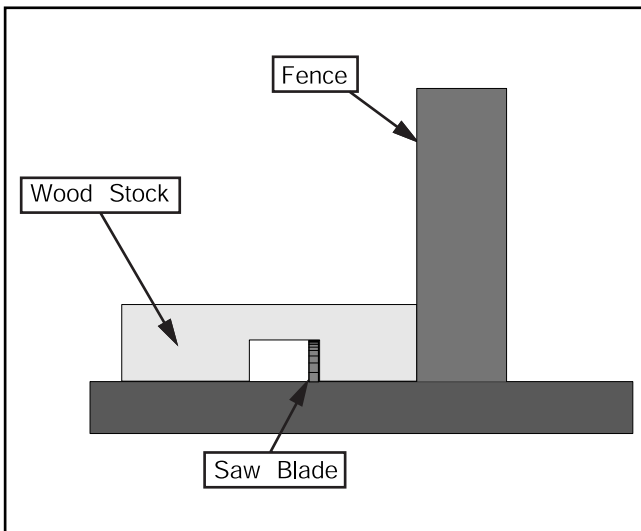
10. If the cut is satisfactory, repeat with your finish stock.

## **!WARNING**

**ALWAYS** replace the blade guard after dadoing is complete. Failure to follow this warning could result in serious personal injury.

### Using a standard saw blade:

1. Clearly mark the width of the dado cut on your workpiece. *Include marks on the edge of your workpiece so you can clearly identify your intended cut while the material is laying flat on the saw table.*
2. Raise the blade up to the desired depth of cut (depth of dado channel desired).
3. If dadoing along the long length of your workpiece, adjust the fence so the blade is aligned with the inside of your dado channel as shown in **Figure 34**.



**Figure 34.** Single-blade dado cut.

## **!WARNING**

Never allow hands or arms to be above or behind the saw blade. Should kickback occur, the hands and arms could be pulled into the saw blade causing serious personal injury.

## **!WARNING**

Always use push sticks, featherboards, push paddles and other safety accessories whenever possible to increase safety and control during operations which require the blade guard and splitter to be removed from the saw. Failure to follow this warning could result in serious personal injury.

4. Turn on the saw and allow the blade to reach full speed.
5. Perform a test cut on a scrap piece of wood. Determine if the depth of cut is correct.
6. If the cut is satisfactory, repeat with your finish stock.

## **!WARNING**

Always turn the saw off and wait until the blade has come to a complete stop before adjusting the fence. Failure to follow this warning could result in serious personal injury.

7. Re-adjust the fence so the blade is aligned with the other edge of the intended dado channel. *Be sure to keep the cuts within your marks; otherwise, the dado will be too big.*
8. Continue making cuts toward the center of the dado with your subsequent cuts until the dado is complete.

## **⚠ WARNING**

Always replace the blade guard after dadoing is complete. Failure to follow this warning could result in serious personal injury.



# Rabbet Cutting

Commonly used in furniture joinery, a rabbet is a straight groove cut in the edge of the workpiece. Rabbets can be cut using either a dado blade (Figure 29) or a standard saw blade.

## **⚠ WARNING**

Rabbet operations present very real hazards requiring proper procedures to avoid serious injury. The chance of kickback is always greater when dado blades are used so extra care must be taken. Any movement of the stock away from the fence will cause kickback. Be certain that stock is flat and straight. Failure to follow these warnings could result in serious personal injury.

### To attach a sacrificial fence:

Rabbet cutting with a dado blade requires the use of a sacrificial fence attachment as shown in Figure 35.

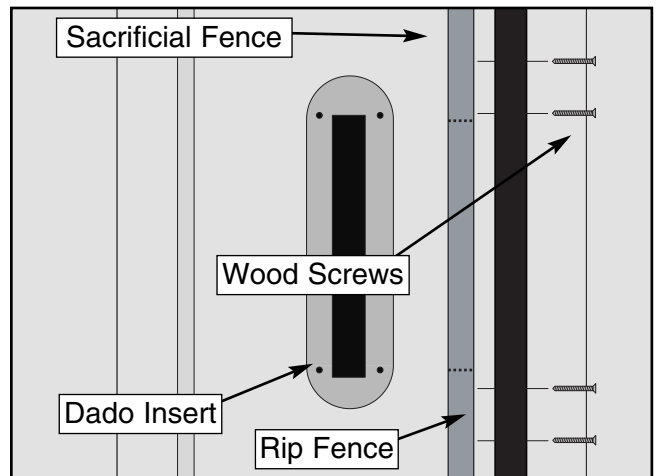


Figure 35. Sacrificial fence.

1. **Disconnect the machine from the power source!**
2. Cut a piece of wood that is as long and tall as the metal fence and  $\frac{3}{4}$ " thick. This will be the sacrificial fence. Make sure the wood is a uniform thickness and free of knots and defects.
3. Attach the sacrificial fence to the metal fence with screws or clamps.
4. Remove the blade guard/splitter assembly, the table insert, and the regular saw blade from the arbor.
5. Install and adjust the dado blade system as recommended in the dado blade instructions.
6. Adjust the saw blade to maximum height needed for the rabbeting operation.
7. Raise the blade an additional  $\frac{1}{4}$ ".
8. Slide the metal fence with the attached sacrificial fence along side the blade.
9. Using a felt pen, draw the blade profile onto the sacrificial fence.
10. Remove the sacrificial fence from the metal fence.
11. Using a bandsaw or jig saw, cut the marked blade profile from the sacrificial fence.
12. Re-attach the sacrificial fence to the metal fence with screws or clamps.

13. Slide the fence assembly over the saw blade. The blade should **NOT** touch the sacrificial fence.

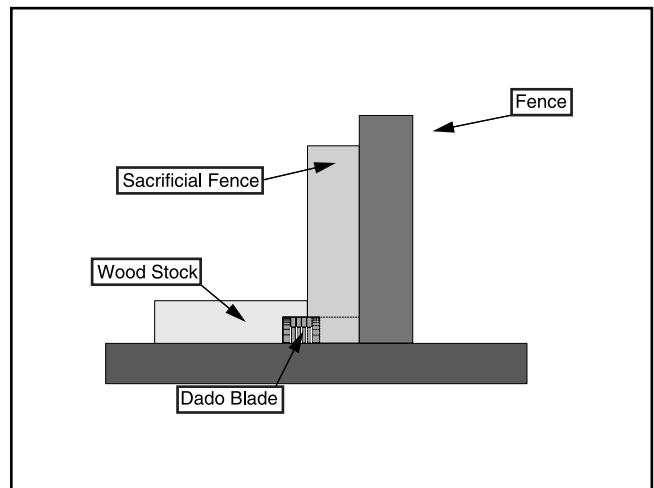
#### Cutting rabbets with the dado blade:

1. Adjust the saw blade to the maximum height needed for the rabbeting operation.

## **!WARNING**

**Never perform a through cut operation with a dado blade. A dado blade was designed to make non-through cuts only. Failure to follow this warning could result in serious personal injury.**

2. If rabbeting along the long length of your workpiece, adjust the distance between the fence and the workpiece to suit your needs as shown in **Figure 36**.



**Figure 36.** Rabbet cutting.

## **!WARNING**

Never allow hands or arms to be above or behind the saw blade. Should kickback occur, the hands and arms can be pulled into the saw blade. Serious personal injury could result.

## **!WARNING**

Always use push sticks, featherboards, push paddles and other safety accessories whenever possible to increase safety and control during operations which require the blade guard and splitter to be removed from the saw. Failure to follow this warning could result in serious personal injury.

3. Reconnect the saw to the power source and turn the saw on.
4. When the blade has reached full speed, perform a test cut with a scrap piece of wood.
5. If the cut is satisfactory, repeat with your finish stock.

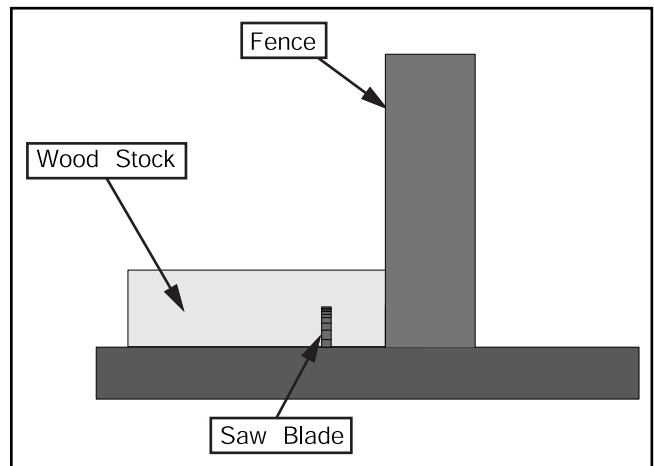
## **!WARNING**

Always replace the blade guard after rabbet cutting is complete. Failure to follow this warning could result in serious personal injury.

### **Cutting rabbets with the standard blade:**

Cutting rabbets with a standard saw blade DOES NOT require the use of a sacrificial fence.

1. Clearly mark the width of the rabbet cut on your workpiece. *Include marks on the edge of your workpiece so you can clearly identify your intended cut while the material is laying flat on the saw table.*
2. Raise the blade up to the desired depth of cut (depth of rabbet channel desired).
3. If the rabbet runs the length of the material, adjust the fence so the blade is aligned with the inside of your rabbet channel as shown in **Figure 37**.



**Figure 37.** Rabbet cutting.

## **!WARNING**

Never allow hands or arms to be above or behind the saw blade. Should kickback occur, the hands and arms can be pulled into the saw blade. Serious personal injury could result.

## **!WARNING**

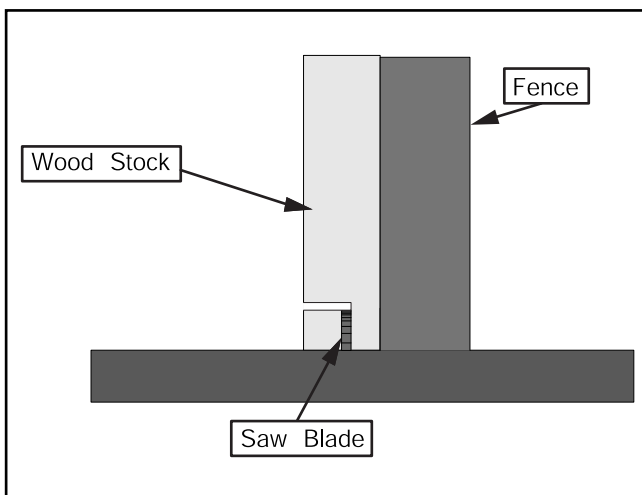
Always use push sticks, featherboards, push paddles and other safety accessories whenever possible to increase safety and control during operations which require the blade guard and splitter to be removed from the saw. Failure to follow this warning could result in serious personal injury.

4. Turn the saw on.
5. When the blade has reached full speed, perform a test cut with a scrap piece of wood.
6. If the cut is satisfactory, repeat with your finish stock.

## **!WARNING**

Always turn the saw off and wait until the blade has come to a complete stop before adjusting the fence. Failure to follow this warning could result in serious personal injury.

7. Rotate the workpiece as shown in **Figure 38**.



**Figure 38.** Rabbit cutting.

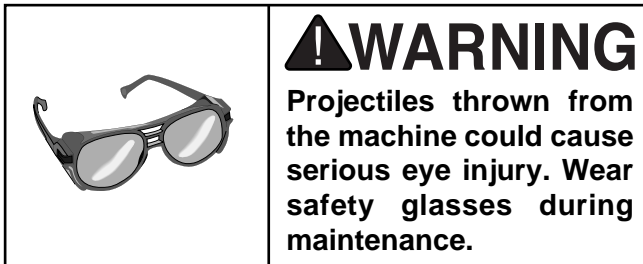
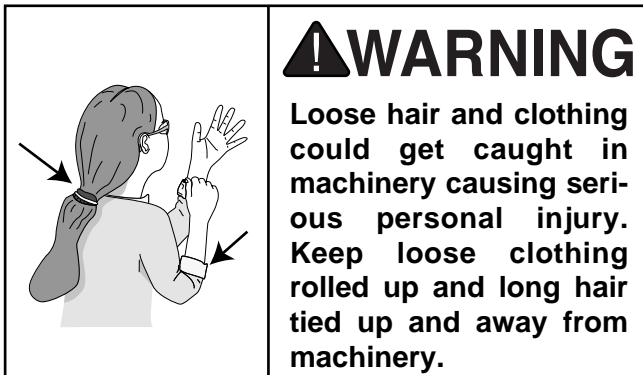
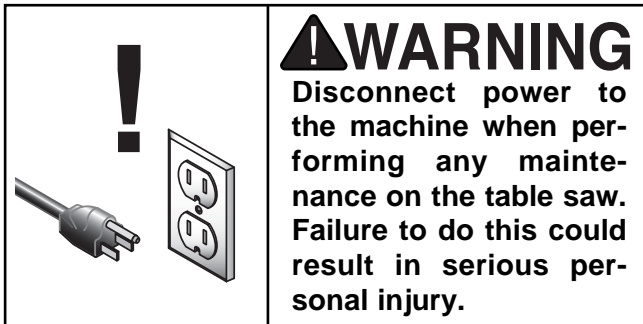
8. Perform the second cut to complete the rabbit cut.

## **!WARNING**

Always replace the blade guard after dadoing is complete. Failure to follow this warning could result in serious personal injury.



# SECTION 7: MAINTENANCE



## General

Regular periodic maintenance on your Model G1023Z Series Table Saw will ensure its optimum performance. Make a habit of inspecting your machine each time you use it.

**Check for the following conditions and repair or replace when necessary:**

1. Loose mounting bolts.
2. Worn switch.
3. Worn or damaged cords and plugs.
4. Damaged V-belt.
5. Any other condition that could hamper the safe operation of this machine.
6. Inspect blades for damage.
7. Guard alignment and operation.





# Lubrication

---

The sealed ball bearings in the motor and throughout the Model G1023Z Series require no maintenance during their lifetime. When they do wear out, replacements can be obtained through the Grizzly Parts Department.

**Lubricate the areas indicated below every 12 months:**

**BLADE ANGLING TRUNNION**—The front and back trunnions each have a semi-circle groove that needs to be lubricated with an automotive wheel bearing grease.

**BLADE HEIGHT TRUNNION**—The blade height trunnion pivots on a steel rod. This should be lubricated with 6 or 7 drops of light machine oil.

**WORM GEARS**—These should be lubricated with an automotive wheel bearing grease.



# Table

---

The table is made from cast iron. If preventative measures are not taken, the table surface will rust. Regularly wipe sawdust from the table to prevent rust causing moisture from becoming trapped against the table. Regular applications of products like SLIPIT® will prevent rust as the saw is used on a daily basis. For long term storage, use products such as Boeshield T-9®. Both of these products are available in the Grizzly catalog.



# V-Belt

---

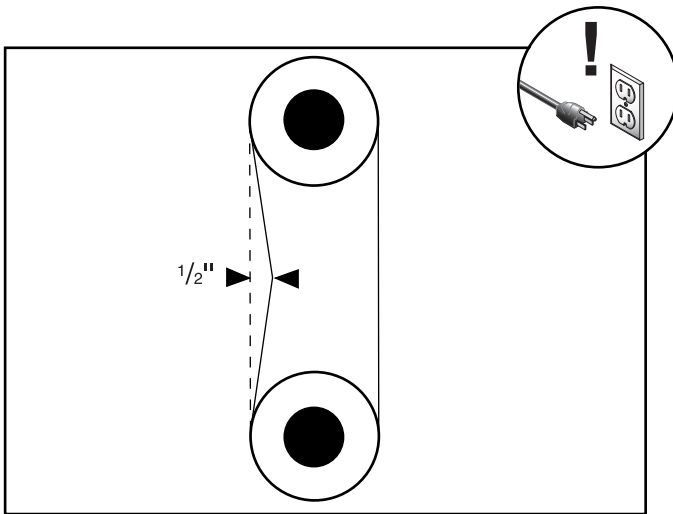
To ensure optimum power transmission from the motor to the blade, the V-belts must be in good condition and operate under the proper tension. When replacing V-belts, replace all three at the same time—even if they do not all appear worn.

Belt tension should be checked at least every 3 months; more often if using the table saw intensively.

The V-belts are accessed through the cavity on the right side of the saw. They link the arbor and motor pulleys.

**To check V-belt tension:**

- 1. Disconnect the machine from the power source!**
2. With moderate pressure, push the center of each V-belt.
3. Note the amount of deflection. Deflection should be approximately ½", similar to **Figure 39**.



**Figure 39.** V-belt deflection.

**To adjust V-belt tension:**

1. **Disconnect the machine from the power source!**
2. Loosen the motor mount bolt.
3. Shift the motor up or down to increase or decrease the V-belt tension. Tighten the motor mount bolt.
4. Check the V-belt tension again. Ensure that the motor pulley and arbor pulley are lined up.

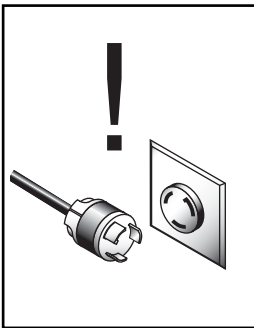
**To replace the V-belts:**

1. **Disconnect the machine from the power source!**
2. Remove the blade.
3. Adjust the arbor so it is up all the way and in the 90° position.
4. Place a board under the motor and loosen the motor mount bolt. Slowly lower the arbor until the motor rests on the board, allowing the belts to be loose on the pulleys.
5. Pull off the old V-belts and replace them with new ones. Have the number from the belt ready when calling the service department for replacements.
6. Raise the arbor and remove the board to adjust the V-belt tension.
7. Tighten the motor mount bolt.

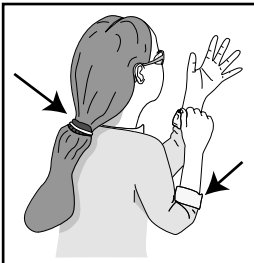




# SECTION 8: SERVICE ADJUSTMENTS



**⚠ WARNING**  
Disconnect power to the machine when performing any maintenance, assembly or adjustments. Failure to do this may result in serious personal injury.



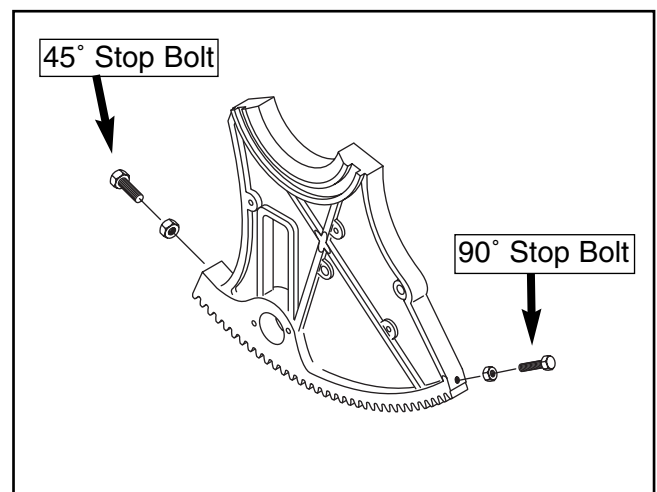
**⚠ WARNING**  
Keep loose clothing rolled up and out of the way of machinery and keep hair pulled back.



**⚠ WARNING**  
Wear safety glasses during the entire adjustment process. Failure to comply may result in serious personal injury.

## 45° & 90° Stops

1. Set your blade angle at zero as shown on the angle indicator on the front of the saw and raise the blade several inches above the table.
2. Place a machinist's square flat on the table and slide it alongside the blade. The square should contact the blade evenly from bottom to top. Make sure that a blade tooth does not obstruct the movement of the square.
3. Adjust the handwheel until the square is flush with the blade. Loosen the tilt indicator arrow, set to zero, and retighten. Loosen and adjust the stop bolt on the left side of the front trunnion to allow a 90° stop point. See **Figure 40** for details.
4. Turn the blade angle handwheel until the angle indicator points at the desired angle.
5. Tighten the handwheel locking knob.
6. Repeat **Steps 1-6** for setting the blade to 45° and adjust the 45° stop bolt on the right side of the front trunnion. Use the 45° side of a combo square or a bevel gauge set at 45°.



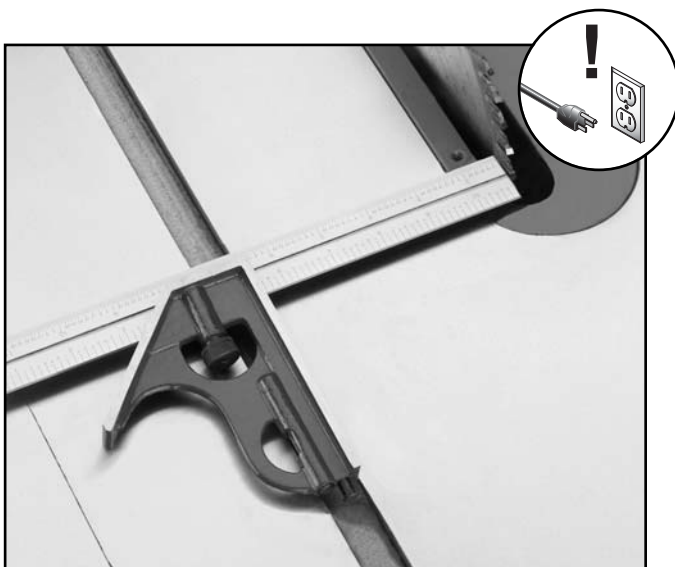
**Figure 40.** Geared trunnion.



# Blade Parallelism

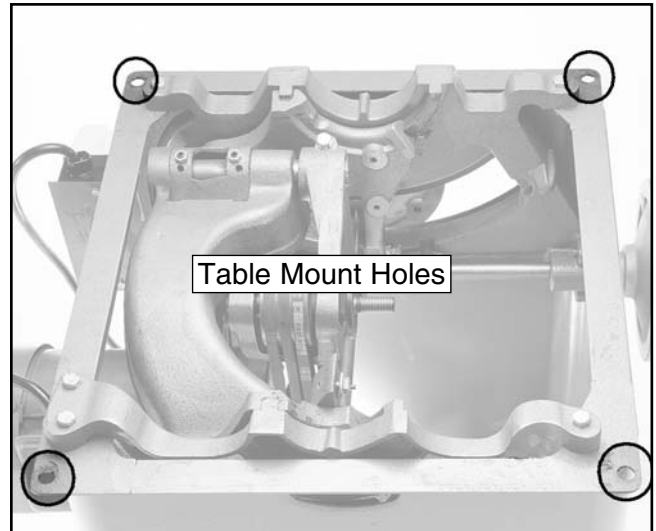
Your table saw will give the best results if the miter slot and the rip fence are adjusted parallel to the blade. If either of these are not exactly parallel, your cuts and your finished work will be lower in quality, but more important, this condition increases the risk of kickback. Take the time to adjust your table saw properly. A few minutes now will be time well spent.

1. **Disconnect the machine from the power source!**
2. Use an adjustable square to measure the distance from the miter slot to a carbide tip on the blade as shown in **Figure 41**. Make sure that the face of the adjustable square is even along the miter slot.
3. With the end of the adjustable square just touching the tip, lock the square in place. Now, mark the carbide tip with a magic marker where you made this measurement.
4. Rotate that tip to the other end of the table insert.
5. Slide the adjustable square down to the other end of the table insert, and compare the distance from the marked blade tip to the end of the adjustable square.



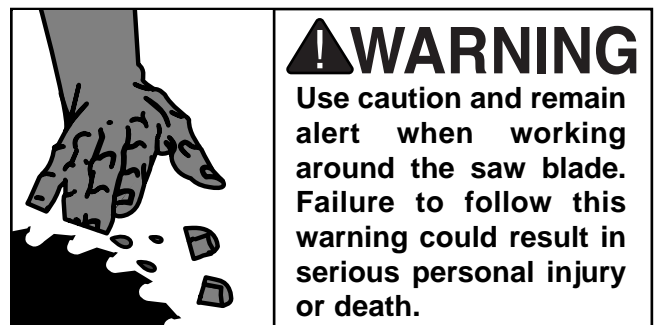
**Figure 41.** Adjusting blade to miter slot.

6. If the blade tip does not touch the end of the adjustable square similar to the first measurement, then the table will need to be adjusted.
7. To adjust the table, loosen the four bolts in the table mounting locations (see **Figure 42**) and slightly tap the table. Repeat **Steps 1-5** until satisfactory. Do not forget to tighten the table mounting bolts when finished.

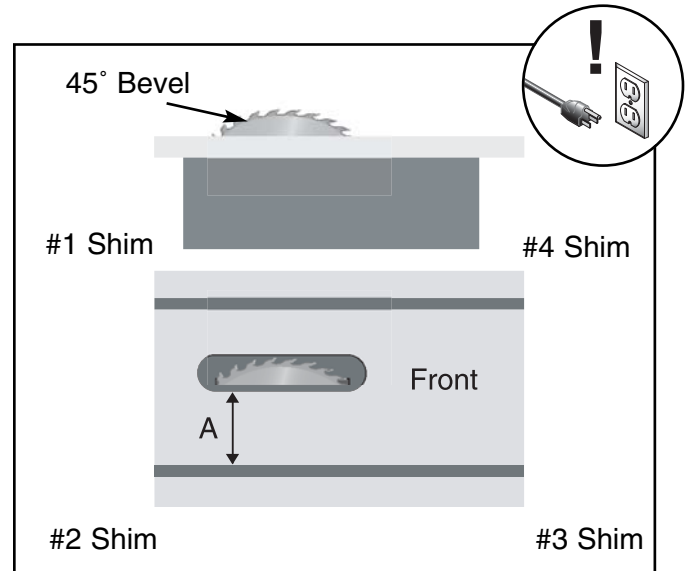


**Figure 42.** Table mounting bolt holes.

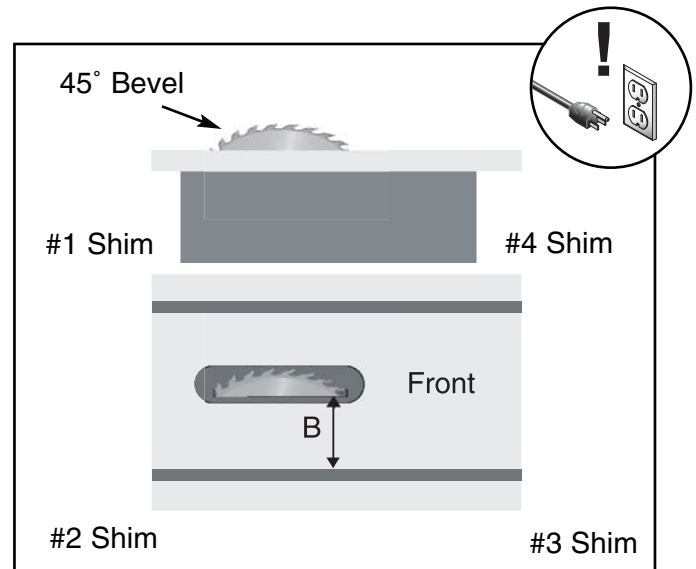
8. Now check to see if the blade remains parallel to the miter slot when tilted to 45°.
9. Tilt the blade to 45° and repeat **Steps 1-5**. If the blade is still parallel to the miter slot, continue on to the “Miter Gauge” instructions. Otherwise, continue with the next step.
10. If the blade was parallel to the miter slot at 90° but not at 45°, the table will need to be shimmed with metal shim stock. The shims are placed between the table and cabinet over each of the four table mounting bolts.



11. Refer to **Figures 43 & 44**, for shim placement. If the distance of A is shorter than B, shim(s) will need to be placed under corners #1 and #2. If the distance of B is shorter than A, shim(s) will need to be placed under corners #3 and #4. Very thin shim stock works well, just make sure they are all the same thickness, and you put an equal number under each of the two corners.
12. Tighten down one bolt a small amount and then move on to each of the others, tightening each down the same amount. Continue to rotate through the bolts, tightening them a little each time until they are all secure.
13. Now recheck the blade to miter slot at 90° and 45° by repeating **Steps 1-5**. If the distance of A and B are equal, continue to the “Miter Gauge” instructions. If the distances are still off, repeat **Steps 9-12**.
14. Once you feel you have the miter slot adjusted to the blade, recheck all measurements and be sure the table mounting bolts are secure. Repeat **Step 12** on **Page 25**. If the table is removed in the future, be sure to re-install the shims the same way they came off.



**Figure 43.** 45° blade parallelism measurement.



**Figure 44.** 45° blade parallelism measurement.

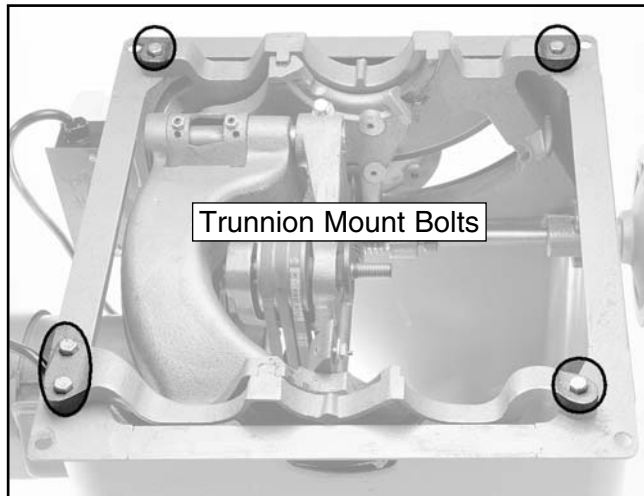


# Blade Alignment

The blade position can be adjusted slightly in case it contacts the table insert when raised or tilted. This adjustment can be made either by moving the whole trunnion assembly, or by just moving the arbor bracket. Try adjusting by moving the whole trunnion first, this is the easier of the two ways.

**To adjust the blade position by moving the trunnion:**

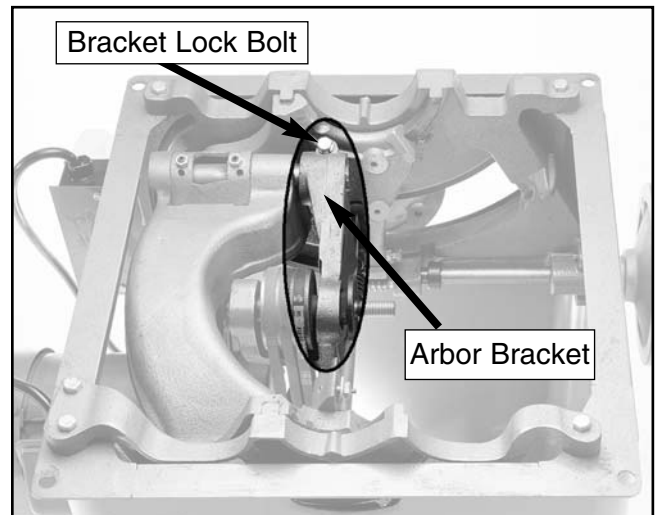
1. **Disconnect the machine from the power source!**
2. Remove the table and wings and set them to one side. Be sure to note the position of the table shims. Replace them to their original position before re-attaching the table.
3. Loosen the four trunnion mounting bolts as shown in **Figure 45**, and nudge to either the left or right depending on where the blade is hitting the saw.



**Figure 45.** Trunnion mounting bolts.



4. Reattach the table, making sure there is adequate blade clearance through all blade adjustments. Recheck guard alignment to the blade and to the table top. Adjust as necessary and tighten down all the bolts before use.
5. If the blade is still contacting the insert, repeat **Steps 1-4**. Check all other adjustments.
6. Recheck the blade to miter slot adjustments, and adjust as necessary.



**Figure 46.** Adjusting arbor bracket.

**To adjust the blade position by moving the arbor bracket:**

1. **Disconnect the machine from the power source!**
2. Remove the table and wings and set them to one side. Be sure to note the position of the table shims. Replace them to their original position before re-attaching the table.
3. Loosen the bracket lock bolt shown in **Figure 46**.
4. Slowly slide the arbor bracket towards the end of the shaft.

## NOTICE

If you make the adjustment described in this section, check and adjust the blade splitter to make sure it aligns with the blade.

5. Moving the arbor bracket moves the V-belts and pulleys out of alignment, so adjustment of the motor pulley is required. Simply loosen the setscrew in the middle motor groove pulley and slowly slide the pulley towards the end of the motor shaft. Once the V-belts are back in alignment, tighten the setscrew securely.
6. Re-attach the table, making sure there is adequate blade clearance through all blade adjustments. Recheck guard alignment to the blade and to the table top. Adjust as necessary and tighten down all the bolts before use.
7. If the blade is still contacting the insert, repeat **Steps 1-6**. Check all other adjustments.
8. Recheck the blade to miter slot adjustments, and adjust as necessary.



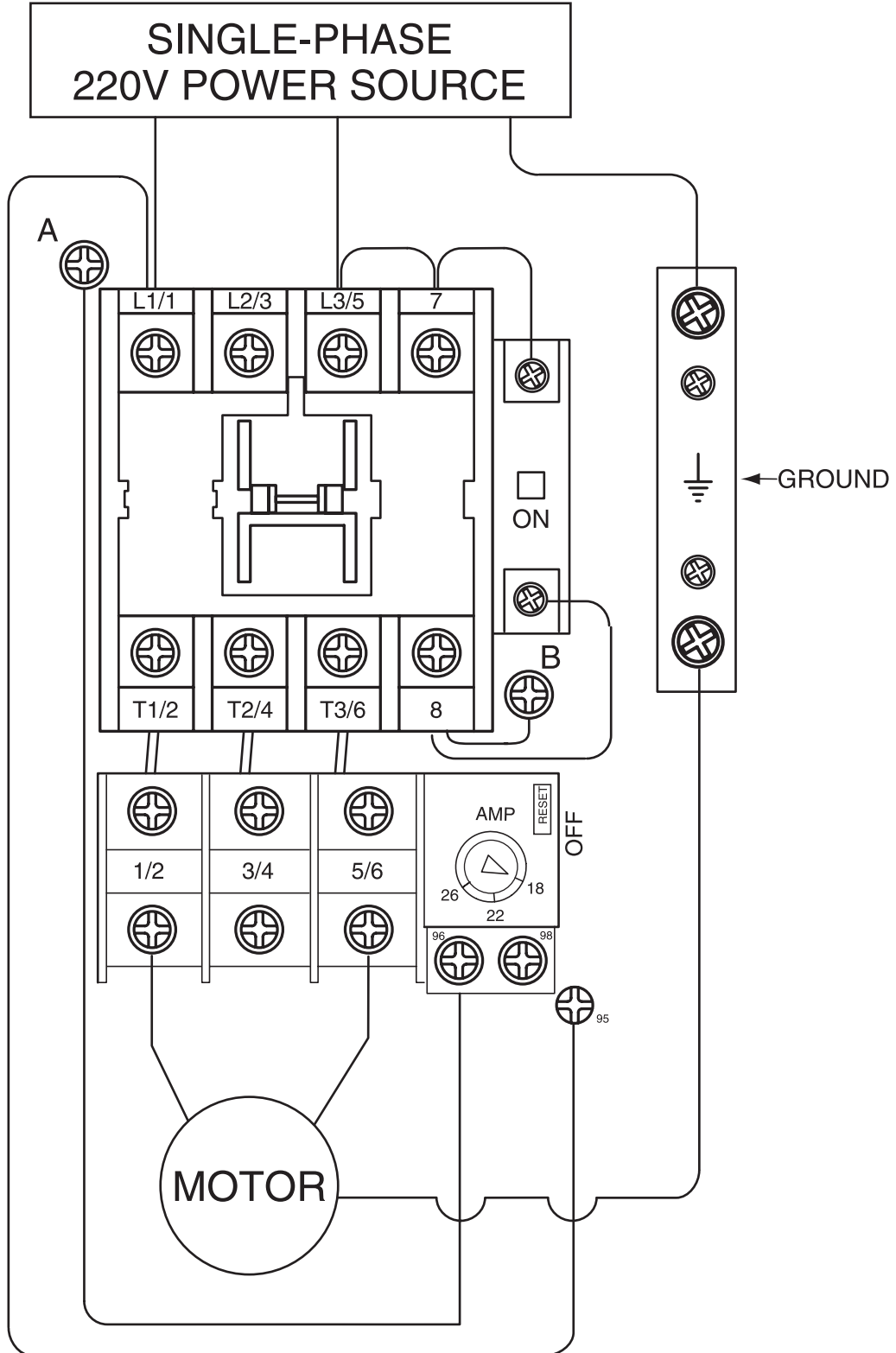


# G1023Z

## 3 HP

### Magnetic Switch

**⚠ DANGER**  
 Disconnect power before performing any electrical service. Electricity presents serious shock hazards that will result in severe personal injury and even death!

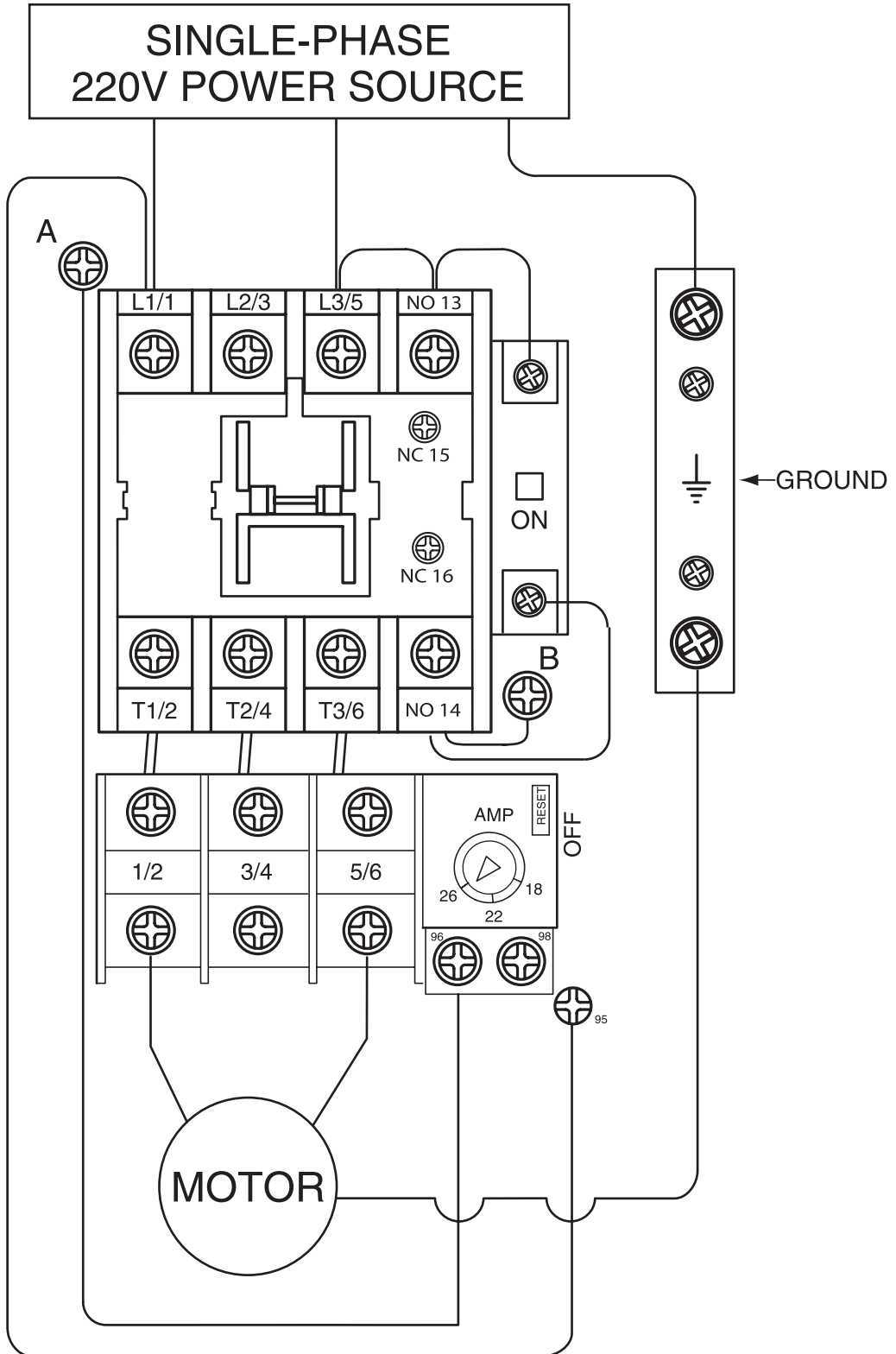


# G1023ZX

## 5 HP

### Magnetic Switch

**⚠ DANGER**  
 Disconnect power before performing any electrical service. Electricity presents serious shock hazards that will result in severe personal injury and even death!



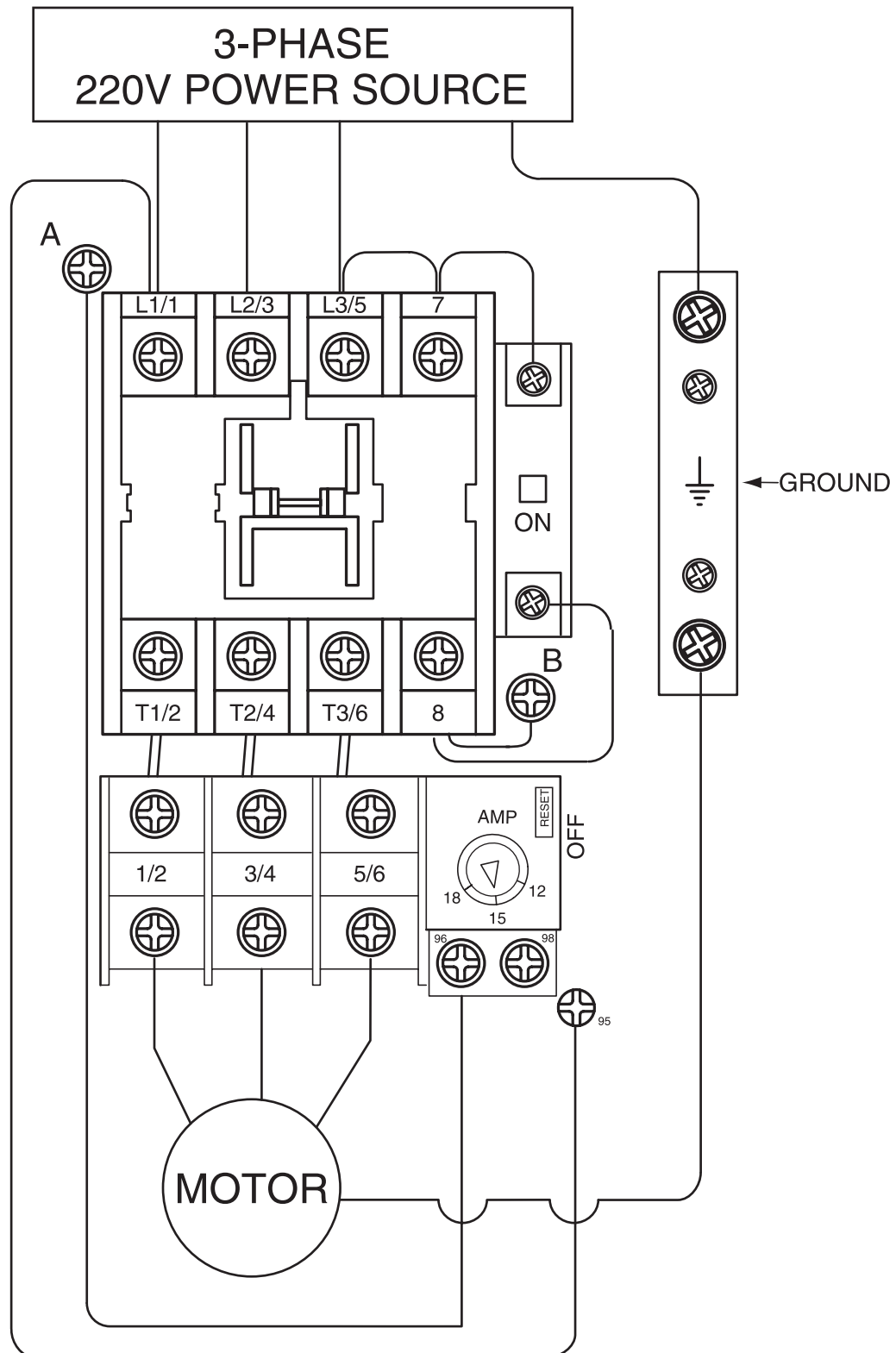
# G1023ZX3

## 5 HP - 3 Phase

### Magnetic Switch

**⚠ DANGER**

Disconnect power before performing any electrical service. Electricity presents serious shock hazards that will result in severe personal injury and even death!



# SECTION 9: CLOSURE

---

The following pages contain general machine data, parts diagrams/lists, a troubleshooting guide and Warranty/Return information.

If you need parts or help in assembling your machine, or if you need operational information, call the Grizzly Service Department. Trained service technicians will be glad to help you.

If you have any comments regarding this manual, please write to Grizzly at the address below:

Grizzly Industrial, Inc.  
c/o Technical Documentation  
P.O. Box 2069  
Bellingham, WA 98227-2069

Important safety measures that are essential to the operation of this machine have been explained in *Section 1: Safety*. While most safety measures are generally universal, Grizzly reminds you that each workshop is different and safety rules should be considered as they apply to your specific situation.

We recommend you keep a copy of our current catalog for complete information regarding Grizzly's warranty and return policy. If you need additional technical information relating to this machine, or if you need general assistance or replacement parts, please contact the Service Department at the location listed below.

Grizzly Industrial, Inc.  
1203 Lycoming Circle  
Muncy, PA 17756  
Phone: (570) 546-9663  
Fax: (800) 438-5901  
E-Mail: [techsupport@grizzly.com](mailto:techsupport@grizzly.com)  
Web Site: <http://www.grizzly.com>.

Additional information sources are necessary to realize the full potential of this machine. Trade journals, woodworking magazines, and your local library are good places to start.





# MACHINE DATA SHEET

Customer Service #: (570) 546-9663 • To Order Call: (800) 523-4777 • Fax #: (800) 438-5901

## G1023Z / G1023ZX / G1023ZX3 10" HEAVY-DUTY CABINET SAW

Design Type ..... Floor Model, 10" Tilting Arbor

### Overall Dimensions:

Table Height Above Floor .....34"  
 Table Size .....27" Deep x 20<sup>1</sup>/<sub>8</sub>" Wide  
 Table Size w/ Extension Wings.....27" Deep x 40<sup>1</sup>/<sub>8</sub>" Wide  
 With Wings and Fence Rails and Fence.....50" W x 46<sup>1</sup>/<sub>2</sub>" D  
 Weight (Shipping) Z .....460 lbs.  
 Weight (Shipping) ZX .....475 lbs.  
 Weight (Shipping) ZX3.....475 lbs.  
 Miter Gauge Slot .....T-Slot <sup>3</sup>/<sub>8</sub>" x <sup>3</sup>/<sub>4</sub>"  
 Footprint .....20" x 20"  
 Overall Height .....38"

### Capacities:

Maximum Blade Diameter .....10"  
 Maximum Depth of Cut at 90° .....3<sup>1</sup>/<sub>8</sub>"  
 Blade Tilt.....0 - 45° Right  
 Maximum Depth of Cut at 45° .....2<sup>1</sup>/<sub>8</sub>"  
 Maximum Rip to Right of Blade (Standard).....25"  
 Maximum Rip to Right of Blade (Optional) .....48"  
 Maximum Rip to Left of Blade .....8<sup>1</sup>/<sub>2</sub>"  
 Distance Front of Table to Center of Blade.....17"  
 Table in Front of Blade at Maximum Cut .....12"  
 Maximum Width of Dado .....1<sup>9</sup>/<sub>16</sub>"

### Construction:

Table ..... Precision Ground Cast Iron  
 Stand .....Pre-Formed Steel  
 Miter Gauge .....Cast Iron / Steel Bar  
 Trunnions .....Cast Iron  
 Spindle Bearings .....Sealed and Lubricated Ball Bearings  
 Fence.....Single Lever, Front & Rear Locking, Steel and Cast Aluminum  
 Rails.....47" x 1<sup>1</sup>/<sub>2</sub>" Steel Angle  
 Guard .....Steel and Clear Plastic  
 Wings .....Ground Cast Iron

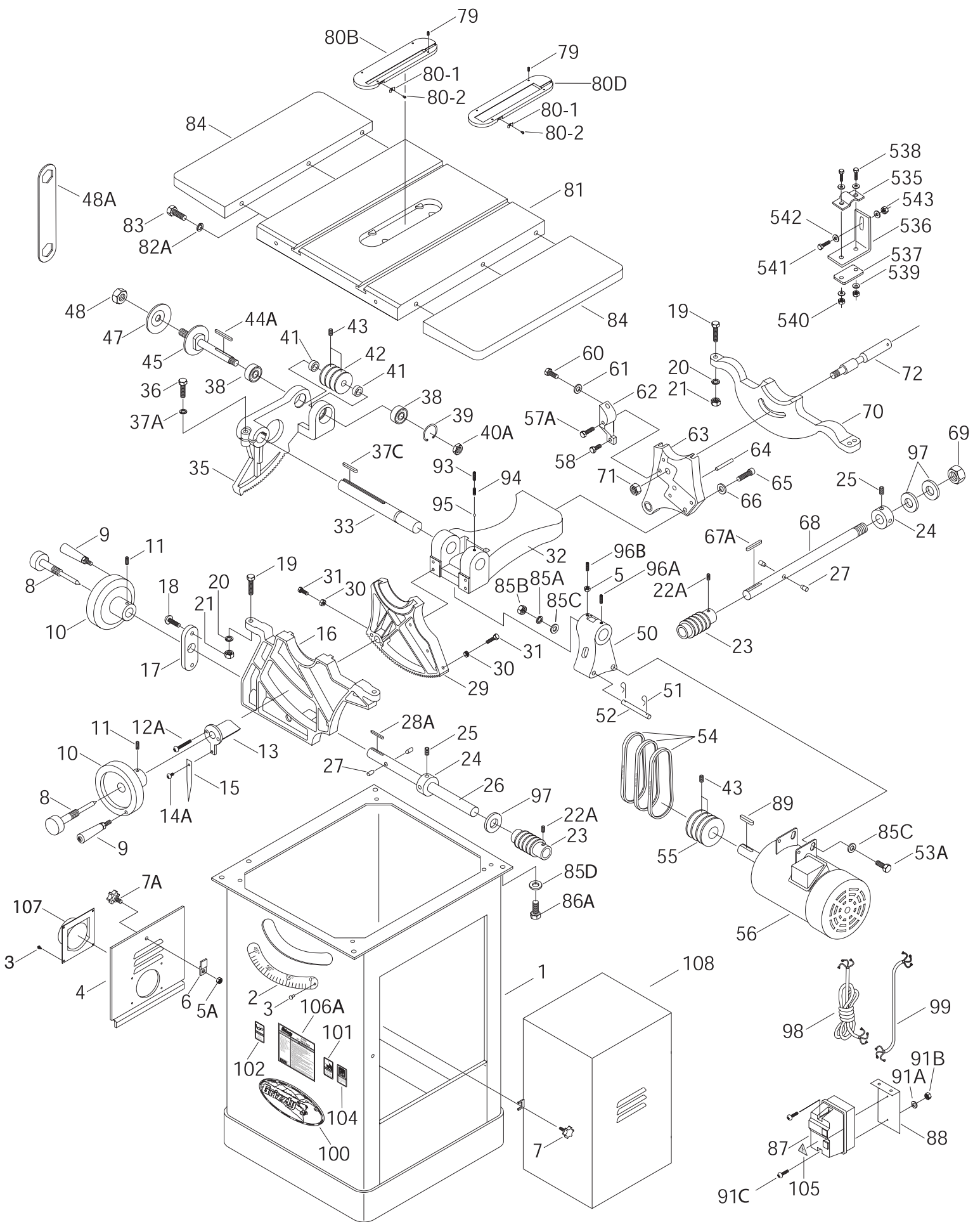
### Motor:

Type (G1023Z & ZX / G1023ZX3) .....TEFC Capacitor Start Induction / Three-Phase  
 Horsepower (G1023Z / G1023ZX / G1023ZX3) .....3 HP / 5 HP / 5 HP  
 Phase (G1023Z / G1023ZX / G1023ZX3) .....Single / Single / Three  
 Voltage .....220V  
 Amps (G1023Z / G1023ZX / G1023ZX3) .....18A / 25A / 15A  
 Motor RPM.....3450 RPM  
 Power Transfer .....Triple Belt Drive  
 Switch .....Magnetic with Thermal Overload Protector

### Features:

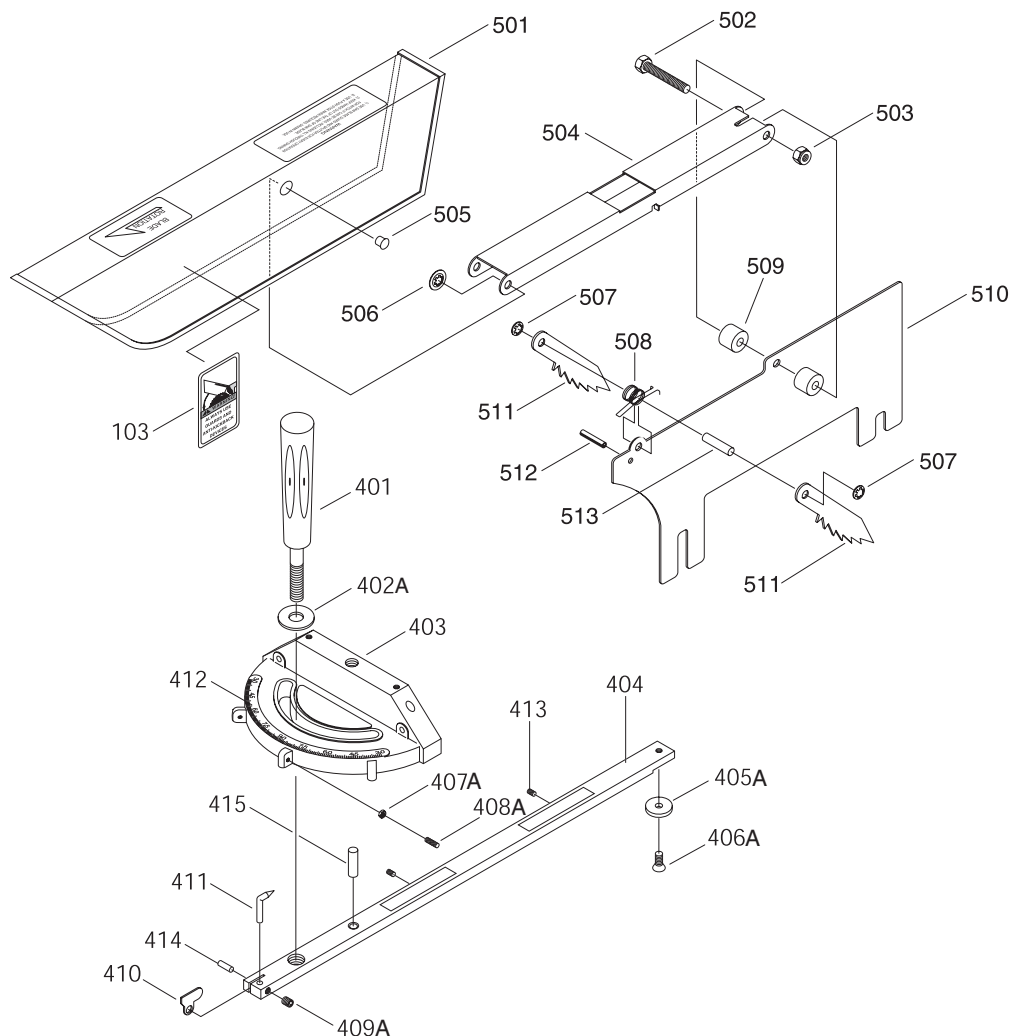
.....Shop Fox® Fence System  
 .....4" Dust Port  
 .....Enclosed Motor Cover, Hinged

*Specifications, while deemed accurate, are not guaranteed.*



REF#	PART#	DESCRIPTION
001	P1023001	CABINET
002	P1023002	SCALE
003	P1023003	SELF TAPPING SCREW
004	P1023004	CLEANOUT DOOR
005A	PN08	HEX NUT 3/8"-16
006	P1023006	DOOR LATCH
007	P1023007	KNOB 3/8"-16 X 1 1/2"
008	P1023008	HAND WHEEL LOCK
009	P1023009	HANDLE
010	P1023010	HAND WHEEL
011	PSS04	SETSCREW 1/4"-20 X 5/16"
012	PSB65	CAP SCREW 10-24 X 2"
013	P1023013	POINTER BRACKET
014	PS27	PHLP HD SCR 5/16"-18 X 3/8"
015	P1023015	POINTER
016	P1023016	FRONT TRUNNION
017	P1023017	PLATE
018	PS05	PHLP HD SCR 5/16"-18 X 1"
019	PB16	HEX BOLT 3/8"-16 X 1 1/2"
020	PLW04	LOCK WASHER 3/8"
021	PN08	HEX NUT 3/8"-16
22A	PSS03	SETSCREW 1/4"-20 X 3/8"
023	P1023023	WORM
024	P1023024	COLLAR
025	PSS05	SETSCREW 5/16"-18 X 1/4"
026	P1023026	SHAFT
027	P1023027	PIN
028	PK02M	KEY 5 X 5 X 40
029	P1023029	GEARED TRUNNION
030	PN02	HEX NUT 5/16"-18
031	PB03	HEX BOLT 5/16"-18 X 1"
032	P1023032	FLANGE
033	P1023033	SHAFT
035	P1023035	GEARED BEARING HOUSING
036	PB16	HEX BOLT 3/8"-16 X 1 1/2"
37A	PLW04	LOCK WASHER 3/8"
37B	PK9	KEY 1/4" X 1/4" X 1 3/4"
038	P6203	BEARING 62032RS
039	PR23M	SNAP RING 40
040	P1023040	LOCK NUT 5/8"-18
041	P1023041	COLLAR
042	P1023042	ARBOR PULLEY
043	PSS07	SETSCREW 1/4" - 20 x 1/2"
044	PK02M	KEY 5 X 5 X 45
045	P1023045	BLADE ARBOR
047	P1023047	ARBOR FLANGE
048	P1023048	ARBOR NUT
48A	P1023048A	ARBOR WRENCH
050	P1023050	MOTOR FRAME SUPPORT
051	P1023051	CLIP
052	P1023052	PIVOT PIN
053	PB75	HEX BOLT 1/2"-13 X 4"
054	P1023054	V-BELTS, SET OF 3
055	P1023055	MOTOR PULLEY
056	P1023056	MOTOR 3 HP 220V
56A	P1023056A	MOTOR 5 HP 220V
56B	P1023056B	MOTOR 5 HP 3-PHASE

REF#	PART#	DESCRIPTION
057	PB76	HEX BOLT 5/16"-18 X 1 5/8"
058	PB03	HEX BOLT 5/16"-18 X 1"
060	PB07	HEX BOLT 5/16"-18 X 3/4"
061	PW07	FLAT WASHER 5/16"
062	P1026062	SUPPORT BRACKET
063	P1023063	FLANGE CASTING
064	PRP03	ROLL PIN 5/16" X 5/8"
065	PSB14	CAP SCREW 3/8"-10 X 1"
066	PW02	FLAT WASHER 3/8"
067	PK02M	KEY 5 X 5 X 40
068	P1023068	SHAFT
069	PLN05	LOCK NUT 3/4"-16
070	P1023070	REAR TRUNNION
071	P1023040	LOCK NUT 5/8"-18
072	P1023072	BLADE GUARD SUPPORT
079	PSS07	SETSCREW 1/4"-20 X 1/2"
80-1	P1023080-1	SPRING CLIP
80-2	PS06	PHLP HD SCREW 10-24 X 3/8"
80B	P1023080B	STD TABLE INSERT
80D	P1023080D	DADO INSERT
081	P1023081	TABLE
082	PLW04	LOCK WASHER 3/8"
083	PB24	HEX BOLT 3/8"-16 X 1 1/4"
084	P1023084	EXTENSION WING
085	PLW05	LOCK WASHER 7/16"
85A	PLW07	LOCK WASHER 1/2"
85B	PN13	HEX NUT 1/2"-13
85C	PW01	FLAT WASHER 1/2"
086	PB77	HEX BOLT 7/16"-20 X 1"
087	G4573(3HP)	SWITCH G1023Z
87A	G4668(5HP)	SWITCH G1023ZX
87B	G4674(5HP3)	SWITCH G1023ZX3
088	P1023088	SWITCH MOUNT BRACKET
089	PK02M	KEY 5 X 5 X 40
090	PS201-1	SWITCH COVER SCREW
091	PS08	PHLP HD SCR 10-24 X 3/4"
91A	PW03	FLAT WASHER #10
91B	PN07	HEX NUT 10-24
093	PSS02	SETSCREW 5/16"-18 X 3/8"
094	P1023094	SPRING
095	P1023095	BALL
096	P1023096	SPECIAL SETSCREW 5/16"-18 X 1/4"
96A	PSS08	SETSCREW 5/16"-18 X 1/2"
097	P1023097	BRASS WASHER
098	P1023098	POWER CORD
099	P1023099	MOTOR CORD
100	P1023100	LOGO PLATE
101	P1023101	DISCONNECT PWR LABEL
102	P1023102	SAFETY GLASSES LABEL
103	P1023103	USE GUARD LABEL
104	P1023104	READ MANUAL LABEL
105	P1023105	ELECTRICITY LABEL
106A	P1023Z106A	WARNING ID LABEL G1023Z
106A	P1023ZX106A	WARNING ID LABEL G1023ZX
106A	P1023ZX3106A	WARNING ID LABEL G1023ZX3
107	P1023107	DUST HOOD
108	P1023108	MOTOR COVER



REF#	PART#	DESCRIPTION
400	P1023400	COMPLETE MITER GAUGE
401	P1023401A	KNOB
402A	PW07	FLAT WASHER 5/16"
403	P1023403	MITER GAUGE BODY
404	P1023404A	MITER BAR
405A	P1023405	RING
406A	PFH26	FLAT HD SCR 10-24 X 1/4"
407A	PN07	HEX NUT 10-24
408A	PSS32	SETSCREW 10-24 X 3/4"
409A	PSS29	SETSCREW 10-24 X 1/4"
410	P1023410	STOP
411	P1023411	POINTER
412	P1023412	SCALE
413	P1023SL413	SETSCREW 10-24 X 5/8"
414	P1023SL414	ROLL PIN 1.5 X 13
415	P1023SL415	MITER HINGE PIN
501	P1022174	GUARD
502	P1022171	HEX BOLT M6-1.0 X 40
503	PLN03M	LOCK NUT M6-1.0

REF#	PART#	DESCRIPTION
504	P1022162	SUPPORTING ARM
505	P1022173	PIVOT PIN
506	P1022175	RETAINER
507	P1022163	RETAINER
508	P1022176	SPRING
509	P1022167	SPACER
510	P1022073	SPLITTER
511	P1022164	PAWL
512	PRP20M	ROLL PIN 4 X 22
513	P1022166	PIN
535	P1023535	U-CLAMP
536	P1023536	L-BRACKET
537	P1023537	LOCKING PLATE
538	PB26	HEX BOLT 1/4"-20 X 1 1/2"
539	PW06	FLAT WASHER 1/4"
540	PN05	HEX NUT 1/4"-20
541	PB07	HEX BOLT 5/16"-18 X 3/4"
542	PW07	FLAT WASHER 5/16"
543	PN02	HEX NUT 5/16"-18



# TROUBLESHOOTING GUIDE

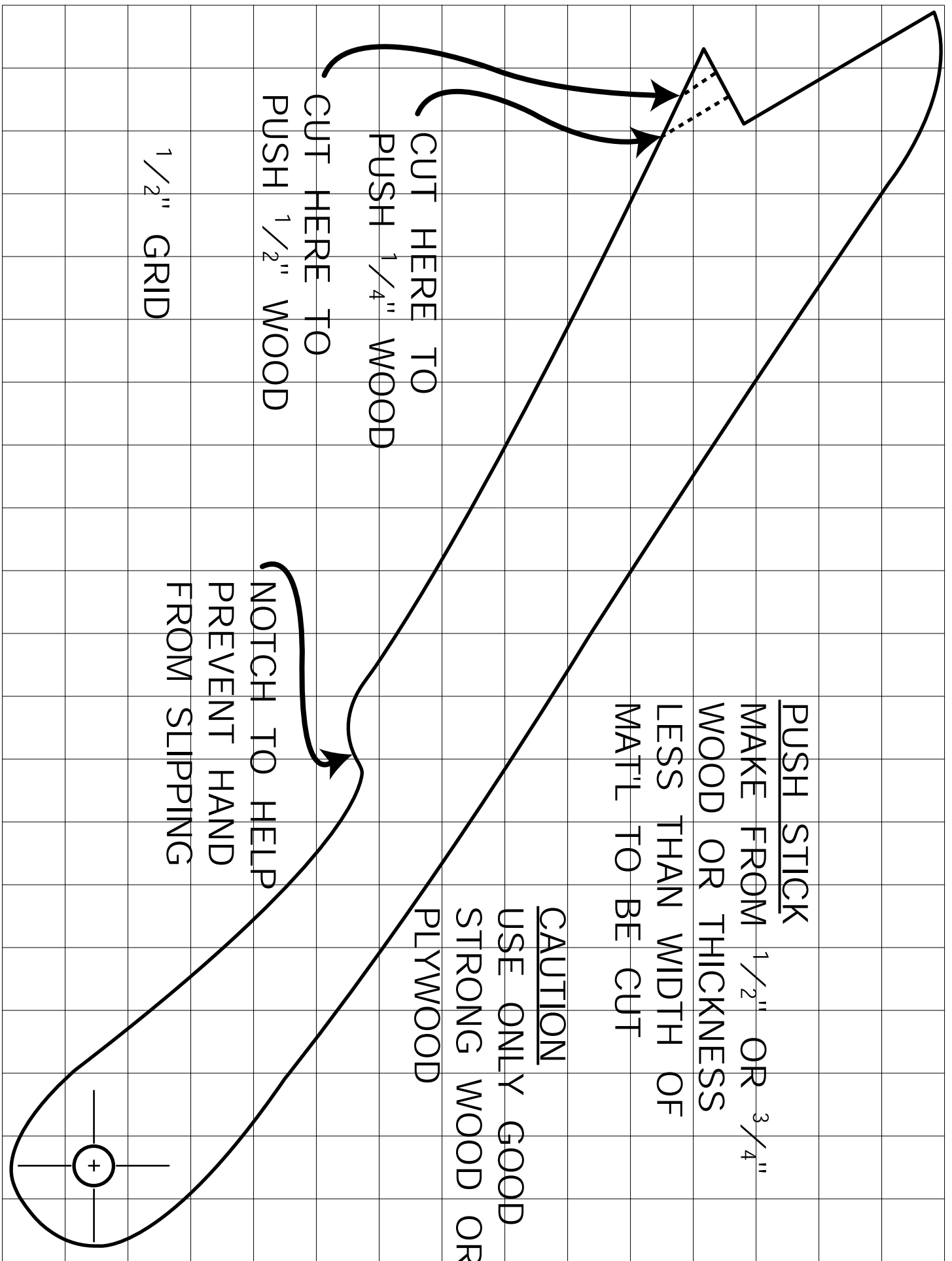
SYMPTOM	POSSIBLE CAUSE	CORRECTIVE ACTION
Motor will not start.	<ol style="list-style-type: none"> <li>1. Low voltage.</li> <li>2. Open circuit in motor or loose connections.</li> </ol>	<ol style="list-style-type: none"> <li>1. Check power line for proper voltage.</li> <li>2. Inspect all lead connections on motor for loose or open connections.</li> </ol>
Motor will not start; fuses or circuit breakers blow.	<ol style="list-style-type: none"> <li>1. Short circuit in line cord or plug.</li> <li>2. Short circuit in motor or loose connections.</li> <li>3. Incorrect fuses or circuit breakers in power line.</li> </ol>	<ol style="list-style-type: none"> <li>1. Inspect cord or plug for damaged insulation and shorted wires.</li> <li>2. Inspect all connections on motor for loose or shorted terminals or worn insulation.</li> <li>3. Install correct fuses or circuit breakers.</li> </ol>
Motor overheats.	<ol style="list-style-type: none"> <li>1. Motor overloaded.</li> <li>2. Air circulation through the motor restricted.</li> </ol>	<ol style="list-style-type: none"> <li>1. Reduce load on motor.</li> <li>2. Clean out motor to provide normal air circulation.</li> </ol>
Motor stalls (resulting in blown fuses or tripped circuit).	<ol style="list-style-type: none"> <li>1. Short circuit in motor or loose connections.</li> <li>2. Low voltage.</li> <li>3. Incorrect fuses or circuit breakers in power line.</li> <li>4. Motor overloaded.</li> </ol>	<ol style="list-style-type: none"> <li>1. Inspect connections on motor for loose or shorted terminals or worn insulation.</li> <li>2. Correct the low voltage conditions.</li> <li>3. Install correct fuses or circuit breakers.</li> <li>4. Reduce load on motor.</li> </ol>
Machine slows when operating.	<ol style="list-style-type: none"> <li>1. Applying too much pressure to workpiece.</li> <li>2. Belts loose.</li> </ol>	<ol style="list-style-type: none"> <li>1. Feed workpiece slower.</li> <li>2. Tighten belts.</li> </ol>
Loud, repetitious noise coming from machine.	<ol style="list-style-type: none"> <li>1. Pulley setscrews or keys are missing or loose.</li> <li>2. Motor fan is hitting the cover.</li> <li>3. V-belts are defective.</li> </ol>	<ol style="list-style-type: none"> <li>1. Inspect keys and setscrews. Replace or tighten if necessary.</li> <li>2. Tighten fan or shim cover.</li> <li>3. Replace V-belts. See <b>Maintenance</b>.</li> </ol>
Blade is not square w/miter slot or fence is not square to blade.	<ol style="list-style-type: none"> <li>1. Blade is warped.</li> <li>2. Table top is not parallel to blade.</li> <li>3. Fence is not parallel to blade.</li> </ol>	<ol style="list-style-type: none"> <li>1. Replace blade.</li> <li>2. Make table parallel to blade. See <b>Adjustments</b>.</li> <li>3. Make fence parallel to blade. See <b>Adjustments</b>.</li> </ol>
Fence hits table top when sliding on to the table.	<ol style="list-style-type: none"> <li>1. Front rail is bolted too low on table.</li> <li>2. Rear rail is bolted too low on the table.</li> </ol>	<ol style="list-style-type: none"> <li>1. Raise front rail.</li> <li>2. Raise rear rail.</li> </ol>
Blade does not reach 90°.	<ol style="list-style-type: none"> <li>1. 90° stop bolt is out of adjustment.</li> <li>2. Pointer bracket is hitting before the blade reaches 90°.</li> </ol>	<ol style="list-style-type: none"> <li>1. Adjust 90° stop bolt. See <b>Adjustments</b>.</li> <li>2. File down the right side of the pointer bracket until the blade can reach 90°.</li> </ol>
Blade hits insert at 45°.	<ol style="list-style-type: none"> <li>1. Hole in insert is inadequate.</li> <li>2. Table out of alignment.</li> <li>3. Blade position is incorrect.</li> </ol>	<ol style="list-style-type: none"> <li>1. File or mill the hole in the insert.</li> <li>2. Align table. See <b>Adjustments</b>.</li> <li>3. Adjust blade position. See <b>Adjustments</b>.</li> </ol>
Blade won't go beneath table surface.	Table top too low.	Raise table top w/washers.
Hand wheels won't turn.	<ol style="list-style-type: none"> <li>1. Hand wheel key is inserted too far.</li> <li>2. Bullets are wedged.</li> <li>3. Roll pin or setscrew in worm gear is contacting geared trunnion.</li> </ol>	<ol style="list-style-type: none"> <li>1. Remove hand wheel and adjust key.</li> <li>2. Remove hand wheel and adjust bullets.</li> <li>3. Inspect roll pins and setscrews in the worm gear. Tighten if necessary.</li> </ol>

# Notes

---

---





# WARRANTY AND RETURNS

---

---

Grizzly Industrial, Inc. warrants every product it sells for a period of **1 year** to the original purchaser from the date of purchase. This warranty does not apply to defects due directly or indirectly to misuse, abuse, negligence, accidents, repairs or alterations or lack of maintenance. This is Grizzly's sole written warranty and any and all warranties that may be implied by law, including any merchantability or fitness, for any particular purpose, are hereby limited to the duration of this written warranty. We do not warrant or represent that the merchandise complies with the provisions of any law or acts unless the manufacturer so warrants. In no event shall Grizzly's liability under this warranty exceed the purchase price paid for the product and any legal actions brought against Grizzly shall be tried in the State of Washington, County of Whatcom.

We shall in no event be liable for death, injuries to persons or property or for incidental, contingent, special, or consequential damages arising from the use of our products.

To take advantage of this warranty, contact us by mail or phone and give us all the details. We will then issue you a "Return Number," which must be clearly posted on the outside as well as the inside of the carton. We will not accept any item back without this number. Proof of purchase must accompany the merchandise.

The manufacturers reserve the right to change specifications at any time because they constantly strive to achieve better quality equipment. We make every effort to ensure that our products meet high quality and durability standards and we hope you never need to use this warranty.

Please feel free to write or call us if you have any questions about the machine or the manual.

Thank you again for your business and continued support. We hope to serve you again soon.

# WARRANTY CARD

Name \_\_\_\_\_  
Street \_\_\_\_\_  
City \_\_\_\_\_ State \_\_\_\_\_ Zip \_\_\_\_\_  
Phone Number \_\_\_\_\_ E-Mail \_\_\_\_\_ FAX \_\_\_\_\_  
MODEL # G1023Z Series 10" Table Saw Order # \_\_\_\_\_

The following information is given on a voluntary basis. It will be used for marketing purposes to help us develop better products and services. Of course, all information is strictly confidential.

- How did you learn about us?  
 Advertisement  Friend  
 Catalog  Card Deck  
 World Wide Web  
 Other \_\_\_\_\_
- Which of the following magazines do you subscribe to.  
 American Woodworker  Practical Homeowner  
 Cabinetmaker  Shop Notes  
 Family Handyman  Today's Homeowner  
 Fine Homebuilding  WOOD  
 Fine Woodworking  Wooden Boat  
 Home Handyman  Woodshop News  
 Journal of Light Construction  Woodsmith  
 Old House Journal  Woodwork  
 Popular Mechanics  Woodworker  
 Popular Science  Woodworker's Journal  
 Popular Woodworking  Workbench  
 Other \_\_\_\_\_
- Which of the following woodworking/remodeling shows do you watch?  
 Backyard America  The New Yankee Workshop  
 Home Time  This Old House  
 The American Woodworker  Woodwright's Shop  
 Other \_\_\_\_\_
- What is your annual household income?  
 \$20,000-\$29,999  \$60,000-\$69,999  
 \$30,000-\$39,999  \$70,000-\$79,999  
 \$40,000-\$49,999  \$80,000-\$89,999  
 \$50,000-\$59,999  \$90,000 +
- What is your age group?  
 20-29  50-59  
 30-39  60-69  
 40-49  70 +
- How long have you been a woodworker?  
 0 - 2 Years  8 - 20 Years  
 2 - 8 Years  20+ Years
- How would you rank your woodworking skills?  
 Simple  Advanced  
 Intermediate  Master Craftsman
- What stationary woodworking tools do you own? Check all that apply.  
 Air Compressor  Panel Saw  
 Band Saw  Planer  
 Drill Press  Power Feeder  
 Drum Sander  Radial Arm Saw  
 Dust Collector  Shaper  
 Horizontal Boring Machine  Spindle Sander  
 Jointer  Table Saw  
 Lathe  Vacuum Veneer Press  
 Mortiser  Wide Belt Sander  
 Other \_\_\_\_\_
- How many of your woodworking machines are Grizzly? \_\_\_\_\_
- Which benchtop tools do you own? Check all that apply.  
 1" x 42" Belt Sander  6" - 8" Grinder  
 5" - 8" Drill Press  Mini Lathe  
 8" Table Saw  10" - 12" Thickness Planer  
 8" - 10" Bandsaw  Scroll Saw  
 Disc/Belt Sander  Spindle/Belt Sander  
 Mini Jointer  
 Other \_\_\_\_\_
- How many of the machines checked above are Grizzly? \_\_\_\_\_
- Which portable/hand held power tools do you own? Check all that apply.  
 Belt Sander  Orbital Sander  
 Biscuit Joiner  Palm Sander  
 Circular Saw  Portable Planer  
 Detail Sander  Saber Saw  
 Drill/Driver  Reciprocating Saw  
 Miter Saw  Router  
 Other \_\_\_\_\_
- What machines/supplies would you like Grizzly Industrial to carry?  
\_\_\_\_\_  
\_\_\_\_\_
- What new accessories would you like Grizzly Industrial to carry?  
\_\_\_\_\_  
\_\_\_\_\_
- What other companies do you purchase your tools and supplies from?  
\_\_\_\_\_  
\_\_\_\_\_
- Do you think your purchase represents good value?  
 Yes  No
- Would you recommend Grizzly Industrial to a friend?  
 Yes  No
- Would you allow us to use your name as a reference for Grizzly customers in your area? **Note: We never use names more than three times.**  
 Yes  No
- Comments: \_\_\_\_\_  
\_\_\_\_\_  
\_\_\_\_\_

CUT ALONG DOTTED LINE

FOLD ALONG DOTTED LINE

\_\_\_\_\_

\_\_\_\_\_

\_\_\_\_\_

|||

Place Stamp Here



**GRIZZLY INDUSTRIAL, INC.**  
**P.O. BOX 2069**  
**BELLINGHAM, WA 98227-2069**



FOLD ALONG DOTTED LINE

Send a Grizzly Catalog to a friend:

Name \_\_\_\_\_

Street \_\_\_\_\_

City \_\_\_\_\_ State \_\_\_\_\_ Zip \_\_\_\_\_

TAPE ALONG EDGES--PLEASE DO NOT STAPLE

# *grizzly.com*

**TOOL WEBSITE**

Buy Direct and Save with Grizzly® – Trusted, Proven and a Great Value!

*Visit Our Website Today And Discover Why  
Grizzly® Is The Industry Leader!*

- SECURE ORDERING
- ORDERS SHIPPED WITHIN 24 HOURS
- E-MAIL RESPONSE WITHIN ONE HOUR

-OR-

Call Today For A **FREE**  
Full Color Catalog

**1-800-523-4777**



## Free Manuals Download Website

<http://myh66.com>

<http://usermanuals.us>

<http://www.somanuals.com>

<http://www.4manuals.cc>

<http://www.manual-lib.com>

<http://www.404manual.com>

<http://www.luxmanual.com>

<http://aubethermostatmanual.com>

Golf course search by state

<http://golfingnear.com>

Email search by domain

<http://emailbydomain.com>

Auto manuals search

<http://auto.somanuals.com>

TV manuals search

<http://tv.somanuals.com>