

Grizzly[®]

Industrial, Inc.

MODEL G0536 16" SCROLL SAW INSTRUCTION MANUAL

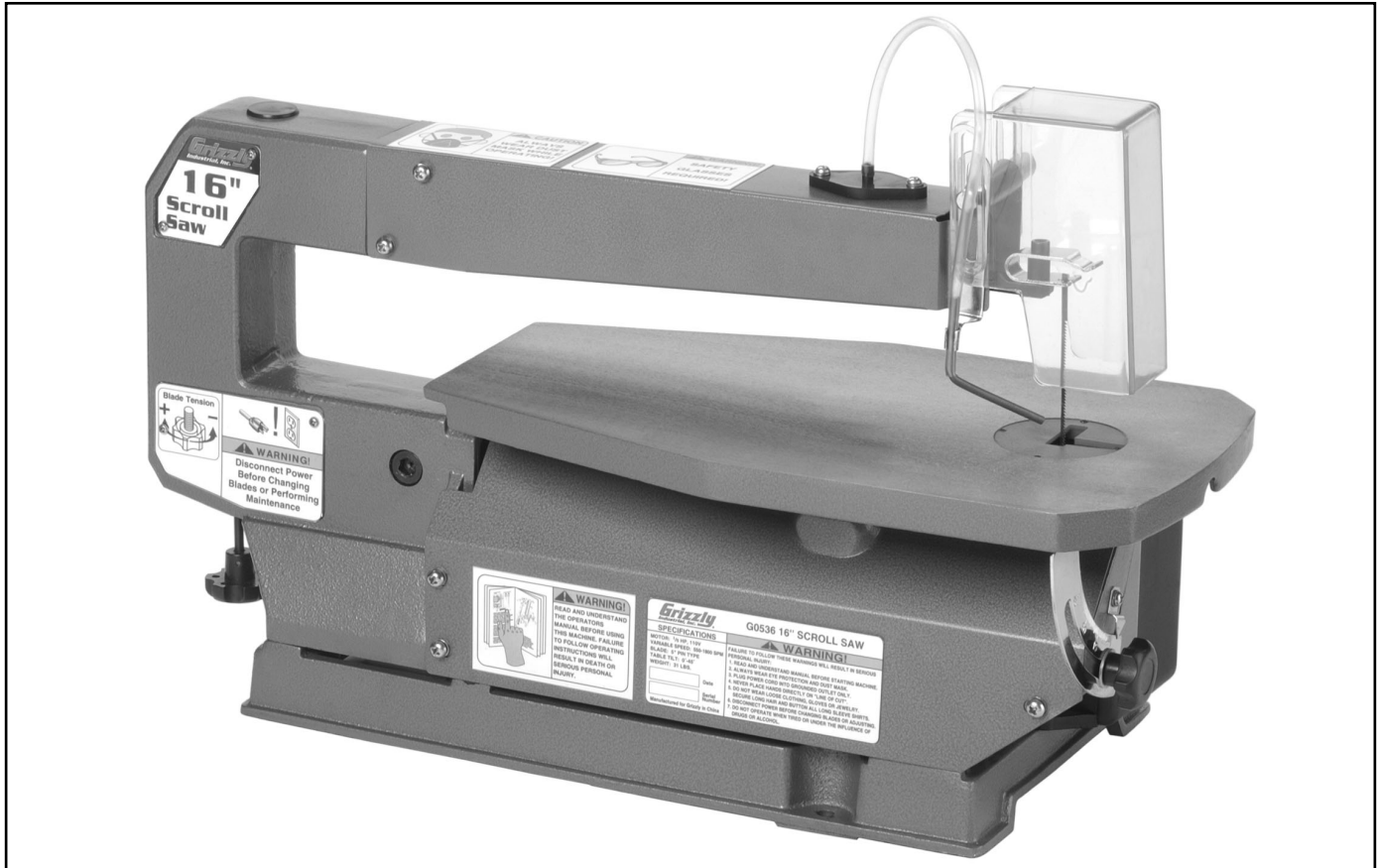

COPYRIGHT © OCTOBER 2003 BY GRIZZLY INDUSTRIAL, INC.

WARNING: NO PORTION OF THIS MANUAL MAY BE REPRODUCED IN ANY SHAPE OR FORM WITHOUT THE WRITTEN APPROVAL OF GRIZZLY INDUSTRIAL, INC.

#5763 PRINTED IN CHINA

ONLINE MANUAL DISCLAIMER

THE INFORMATION IN THIS MANUAL REPRESENTS THE CONFIGURATION OF THE MACHINE AS IT IS CURRENTLY BEING SHIPPED. THE MACHINE CONFIGURATION CAN CHANGE AS PRODUCT IMPROVEMENTS ARE INCORPORATED. IF YOU OWN AN EARLIER VERSION OF THE MACHINE, THIS MANUAL MAY NOT EXACTLY DEPICT YOUR MACHINE. CONTACT CUSTOMER SERVICE IF YOU HAVE ANY QUESTIONS ABOUT DIFFERENCES. PREVIOUS VERSIONS ARE NOT AVAILABLE ONLINE.

WARNING

Some dust created by power sanding, sawing, grinding, drilling, and other construction activities contains chemicals known to the State of California to cause cancer, birth defects or other reproductive harm. Some examples of these chemicals are:

- Lead from lead-based paints.
- Crystalline silica from bricks, cement, and other masonry products.
- Arsenic and chromium from chemically treated lumber.

Your risk from these exposures varies, depending on how often you do this type of work. To reduce your exposure to these chemicals: work in a well ventilated area, and work with approved safety equipment, such as those dust masks that are specially designed to filter out microscopic particles.

Table Of Contents

SECTION 1: SAFETY	2
Safety Instructions For Power Tools	2
Additional Safety Instructions For Scroll Saws	4
SECTION 2: INTRODUCTION	5
Commentary	5
SECTION 3: CIRCUIT REQUIREMENTS	6
110 Volt	6
Grounding	7
Extension Cords	7
SECTION 4: MACHINE FEATURES	8
SECTION 5: SET UP	10
Unpacking	10
G0536 Inventory	10
Site Considerations	11
Clean Up	11
Beginning Assembly	12
Attach Blade Guard.....	12
Installing Blades	13
Test Run	13
SECTION 6: OPERATIONS	14
General	14
Blade Speed	14
Changing Blades.....	15
Straight Cuts	16
Curved Cuts	16
Inside Cuts	17
Bevel Cuts.....	17
SECTION 7: MAINTENANCE	18
Maintenance Safety	18
General	18
Lubrication.....	19
Replacing Brushes	19
SECTION 8: SERVICE ADJUSTMENTS	20
About Service	20
Squaring Table	20
SECTION 9: REFERENCE INFO	21
General	21
Aftermarket Accessories	21
G0536 Parts Breakdown.....	22
G0536 Parts List	23
G0536 Machine Data Sheet	24
Troubleshooting Guide	25
Warranty & Returns.....	26

SECTION 1: SAFETY

WARNING

For Your Own Safety Read Instruction Manual Before Operating This Equipment

The purpose of safety symbols is to attract your attention to possible hazardous conditions. This manual uses a series of symbols and signal words which are intended to convey the level of importance of the safety messages. The progression of symbols is described below. Remember that safety messages by themselves do not eliminate danger and are not a substitute for proper accident prevention measures.



Indicates an imminently hazardous situation which, if not avoided, WILL result in death or serious injury.



Indicates a potentially hazardous situation which, if not avoided, COULD result in death or serious injury.



Indicates a potentially hazardous situation which, if not avoided, MAY result in minor or moderate injury. It may also be used to alert against unsafe practices.

NOTICE

This symbol is used to alert the user to useful information about proper operation of the equipment.

WARNING

Safety Instructions For Power Tools

1. **KEEP GUARDS IN PLACE** and in working order.
2. **REMOVE ADJUSTING KEYS AND WRENCHES.** Form a habit of checking to see that keys and adjusting wrenches are removed from tool before turning on.
3. **KEEP WORK AREA CLEAN.** Cluttered areas and benches invite accidents.
4. **NEVER USE IN DANGEROUS ENVIRONMENT.** DO NOT use power tools in damp or wet locations, or where any flammable or noxious fumes may exist. Keep work area well lighted.
5. **KEEP CHILDREN AND VISITORS AWAY.** All children and visitors should be kept at a safe distance from work area.
6. **MAKE WORKSHOP CHILD PROOF** with padlocks, master switches, or by removing starter keys.
7. **NEVER FORCE TOOL.** It will do the job better and safer at the rate for which it was designed.
8. **USE RIGHT TOOL.** DO NOT force tool or attachment to do a job for which it was not designed.

WARNING

Safety Instructions For Power Tools

9. **USE PROPER EXTENSION CORD.** Make sure your extension cord is in good condition. Conductor size should be in accordance with the chart below. The amperage rating should be listed on the motor or tool nameplate. An undersized cord will cause a drop in line voltage resulting in loss of power and overheating. Your extension cord must also contain a ground wire and plug pin. Always repair or replace extension cords if they become damaged.

Minimum Gauge for Extension Cords

AMP RATING	LENGTH		
	25ft	50ft	100ft
0-6	16	16	16
7-10	16	16	14
11-12	16	16	14
13-16	14	12	12
17-20	12	12	10
21-30	10	10	No

10. **WEAR PROPER APPAREL.** DO NOT wear loose clothing, gloves, neckties, rings, bracelets, or other jewelry which may get caught in moving parts. Non-slip footwear is recommended. Wear protective hair covering to contain long hair.
11. **ALWAYS USE SAFETY GLASSES.** Also use face or dust mask if cutting operation is dusty. Everyday eyeglasses only have impact resistant lenses, they are NOT safety glasses.
12. **SECURE WORK.** Use clamps or a vise to hold work when practical. It's safer than using your hand and frees both hands to operate tool.
13. **DO NOT OVER-REACH.** Keep proper footing and balance at all times.
14. **MAINTAIN TOOLS WITH CARE.** Keep tools sharp and clean for best and safest performance. Follow instructions for lubricating and changing accessories.

15. **USE RECOMMENDED ACCESSORIES.** Consult the owner's manual for recommended accessories. The use of improper accessories may cause risk of injury.

16. **REDUCE THE RISK OF UNINTENTIONAL STARTING.** On machines with magnetic contact starting switches there is a risk of starting if the machine is bumped or jarred. Always disconnect from power source before adjusting or servicing. Make sure switch is in OFF position before reconnecting.

17. **CHECK DAMAGED PARTS.** Before further use of the tool, a guard or other part that is damaged should be carefully checked to determine that it will operate properly and perform its intended function. Check for alignment of moving parts, binding of moving parts, breakage of parts, mounting, and any other conditions that may affect its operation. A guard or other part that is damaged should be properly repaired or replaced.

18. **NEVER LEAVE TOOL RUNNING UNATTENDED. TURN POWER OFF.** DO NOT leave tool until it comes to a complete stop.

19. **NEVER OPERATE A MACHINE WHEN TIRED, OR UNDER THE INFLUENCE OF DRUGS OR ALCOHOL.** Full mental alertness is required at all times when running a machine.

20. **NEVER ALLOW UNSUPERVISED OR UNTRAINED PERSONNEL TO OPERATE THE MACHINE.** Make sure any instructions you give in regards to machine operation are approved, correct, safe, and clearly understood.

21. **IF AT ANY TIME YOU ARE EXPERIENCING DIFFICULTIES** performing the intended operation, stop using the machine! Then contact our service department or ask a qualified expert how the operation should be performed.

WARNING

Additional Safety Instructions For Scroll Saws

1. **SCROLL SAW SAFETY BEGINS** with your lumber. Inspect your stock carefully before you begin a cut. If you have any doubts about the stability or structural integrity of your stock, **DO NOT CUT!**
2. **KEEP HANDS AWAY FROM BLADE.** DO NOT hold pieces so small that your fingers go under the blade guard. DO NOT reach underneath work or in blade cutting path with your hands or fingers for any reason.
3. **AVOID POSITIONS** where a slip could cause your hand to go into the blade.
4. **NEVER USE YOUR SCROLL SAW WITH THE BLADE GUARD REMOVED.**
5. **WAIT UNTIL BLADE IS STOPPED** before clearing away cut-off pieces.
6. **UNPLUG YOUR SCROLL SAW** and remove the safety switch key before changing blades, adjustments, or performing maintenance.
7. **USE BLADES APPROPRIATE FOR YOUR MACHINE,** material being cut, and the type of cut that you are performing.
8. **DO NOT START THE SAW WITH THE BLADE IN CONTACT WITH THE WORKPIECE.**
9. **SUPPORT LARGE WORKPIECES** to reduce blade breakage and pinching.
10. **FIRMLY SECURE YOUR SCROLL SAW** to a stable, level table or workbench using clamps or bolts. The saw may move when cutting large workpieces if not secured.
11. **HABITS — GOOD AND BAD — ARE HARD TO BREAK.** Develop good habits in your shop and safety will become second-nature to you.
12. **PROLONGED EXPOSURE TO WOOD DUST IS KNOWN TO CAUSE CANCER IN HUMANS.** Always wear an OSHA-approved respirator when working in an environment that could contain wood dust.

WARNING

Like all machines there is danger associated with the Model G0536 Scroll Saw. Accidents are frequently caused by lack of familiarity or failure to pay attention. Use this machine with respect and caution to lessen the possibility of operator injury. If normal safety precautions are overlooked or ignored, serious personal injury may occur.

CAUTION

No list of safety guidelines can be complete. Every shop environment is different. Always consider safety first, as it applies to your individual working conditions. Use this and other machinery with caution and respect. Failure to do so could result in serious personal injury, damage to equipment, or poor work results.

SECTION 2: INTRODUCTION

Commentary

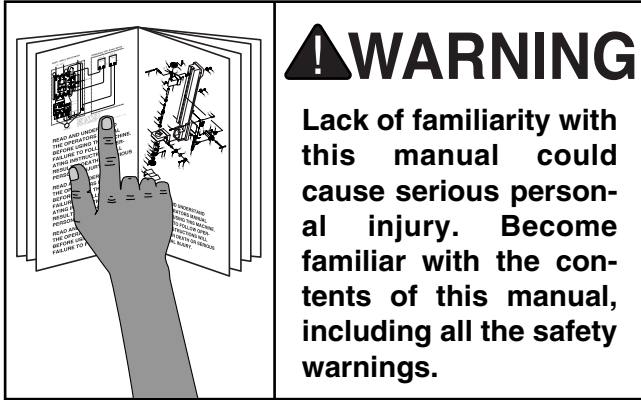

We are proud to offer the Model G0536 Scroll Saw. This machine is part of a growing Grizzly family of fine woodworking machinery. When used according to the guidelines set forth in this manual, you can expect years of trouble-free, enjoyable operation and proof of Grizzly's commitment to customer satisfaction.

We are pleased to provide this manual with the Model G0536. It was written to guide you through assembly, review safety considerations, and cover general operating procedures. It represents our effort to produce the best documentation possible. If you have any comments regarding this manual, please write to us at the address below:

Grizzly Industrial, Inc.
% Technical Documentation
P.O. Box 2069
Bellingham, WA 98227-2069

Most importantly, we stand behind our machines. If you have any service questions or parts requests, please call or write us at the location listed below.

Grizzly Industrial, Inc.
1203 Lycoming Mall Circle
Muncy, PA 17756
Phone: (570) 546-9663
Fax: (800) 438-5901
E-Mail: techsupport@grizzly.com
Web Site: <http://www.grizzly.com>

The specifications, drawings, and photographs illustrated in this manual represent the Model G0536 as supplied when the manual was prepared. However, owing to Grizzly's policy of continuous improvement, changes may be made at any time with no obligation on the part of Grizzly. For your convenience, we always keep current Grizzly manuals available on our website at www.grizzly.com. Any updates to your machine will be reflected in these manuals as soon as they are complete. Visit our site often to check for the latest updates to this manual!



SECTION 3: CIRCUIT REQUIREMENTS

110 Volt

Amperage Draw

The Model G0536 motor is wired to operate at 110V and draw the following load:

Motor Load1.4 Amps

Plug Type

The Model G0536 is supplied with a NEMA 5-15 plug. DO NOT modify the plug or power cord in any way. See **Figure 1** for a NEMA 5-15 plug and grounded outlet.

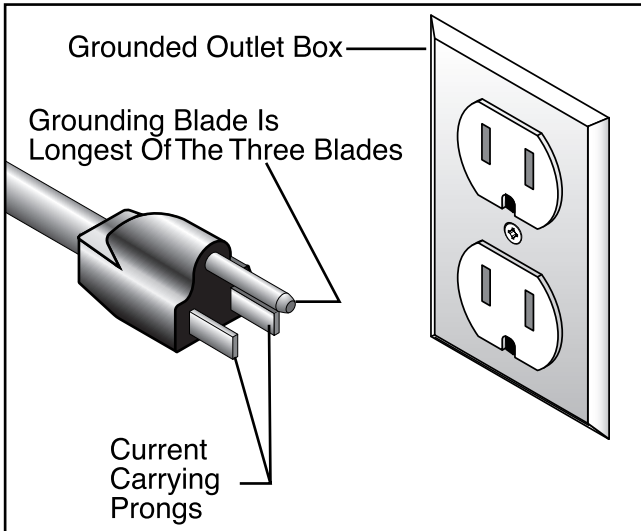

Figure 1. NEMA 5-15 plug and grounded outlet.

Circuit Breaker Requirements

Use the following guidelines when choosing a circuit breaker for your machine:

Recommended Circuit Breaker5 Amp

Your Circuit Capacity

Always check to see if the wires in your circuit are capable of handling the amperage load from your machine. If you are unsure, consult a qualified electrician.

If you operate this machine on any circuit that is already close to its capacity, it might blow a fuse or trip a circuit breaker. However, if an unusual load does not exist and a power failure still occurs, contact a qualified electrician or our Service Department at (570) 546-9663.

⚠ WARNING

Serious personal injury could occur if you connect your machine to the power source before you have completed the assembly process. DO NOT connect the machine to the power source until instructed to do so.



Grounding

In the event of an electrical short, grounding reduces the risk of electric shock by providing a path of least resistance to disperse electric current. This tool is equipped with a power cord that has an equipment-grounding prong. The outlet must be properly installed and grounded in accordance with all local codes and ordinances.

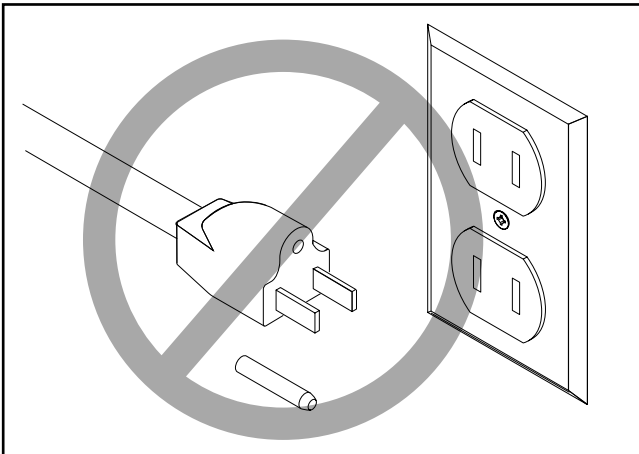
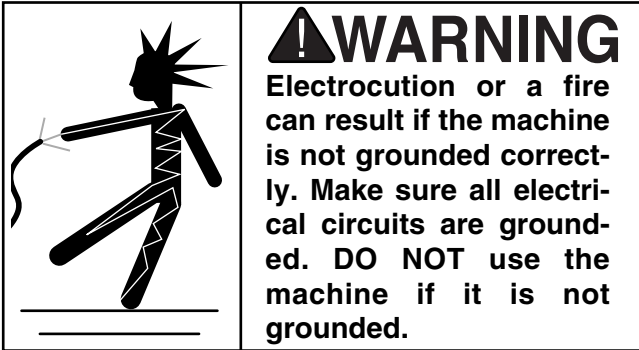

⚠ CAUTION

This machine must have a ground prong in the plug to help ensure that it is grounded. **DO NOT** remove ground prong from plug to fit into a two-pronged outlet! If the plug will not fit the outlet, have the proper outlet installed by a qualified electrician.

NOTICE

The wire on the power cord with green or green and yellow striped insulation is the grounding conductor.



Extension Cords

Operation

If you find it necessary to use an extension cord:

- Make sure the cord is rated Standard Service (grade S) or better.
- The extension cord must also contain a ground wire and plug pin.
- Use at least a 16 gauge cord.
- **DO NOT** use a cord longer than 100 feet!

⚠ CAUTION

No single list of electrical guidelines can be comprehensive for all shop environments. Operating this machinery may require additional electrical upgrades specific to your machine and shop environment. It is your responsibility to make sure your electrical systems comply with all local electrical codes and ordinances.



SECTION 4: MACHINE FEATURES

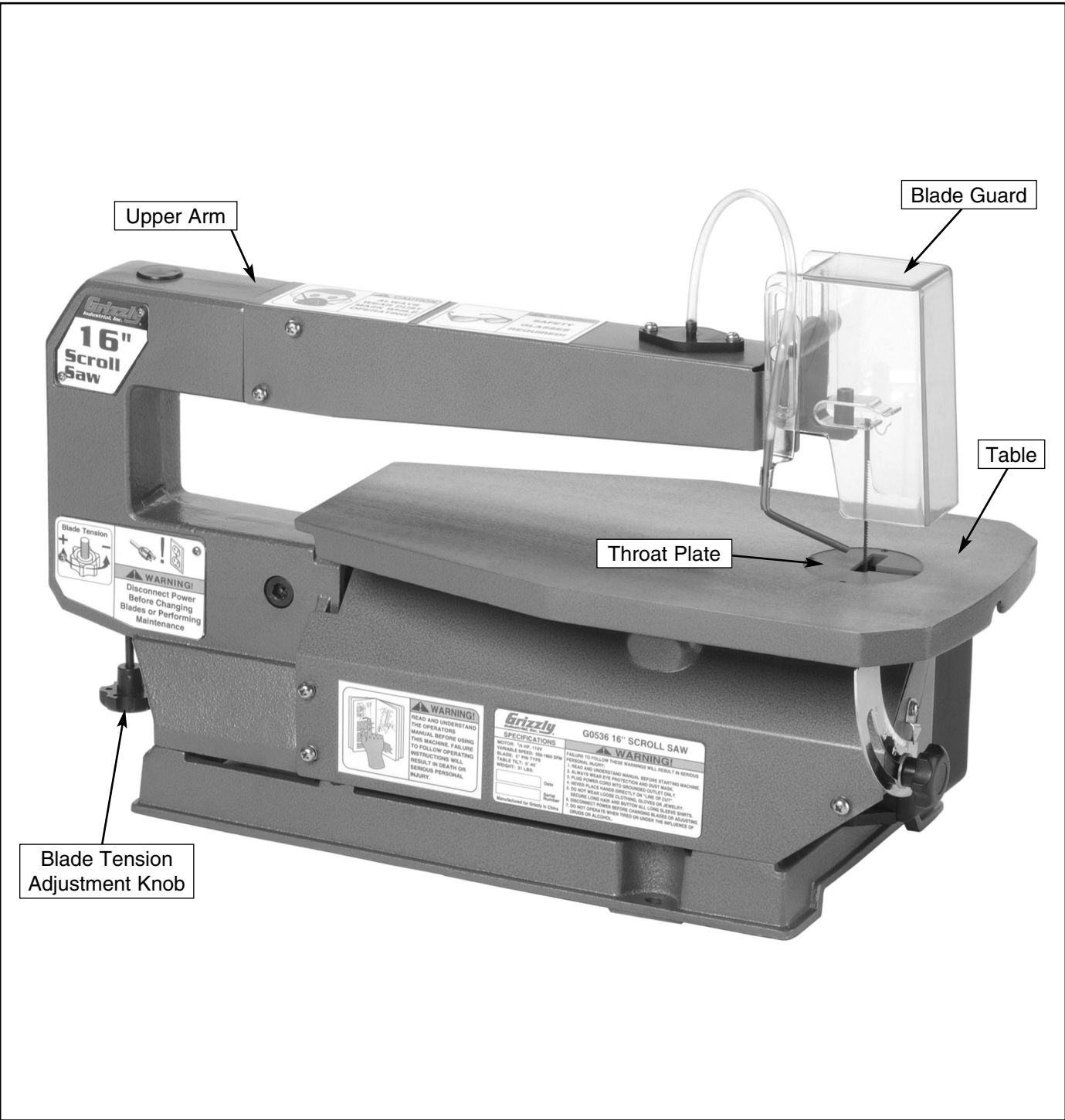

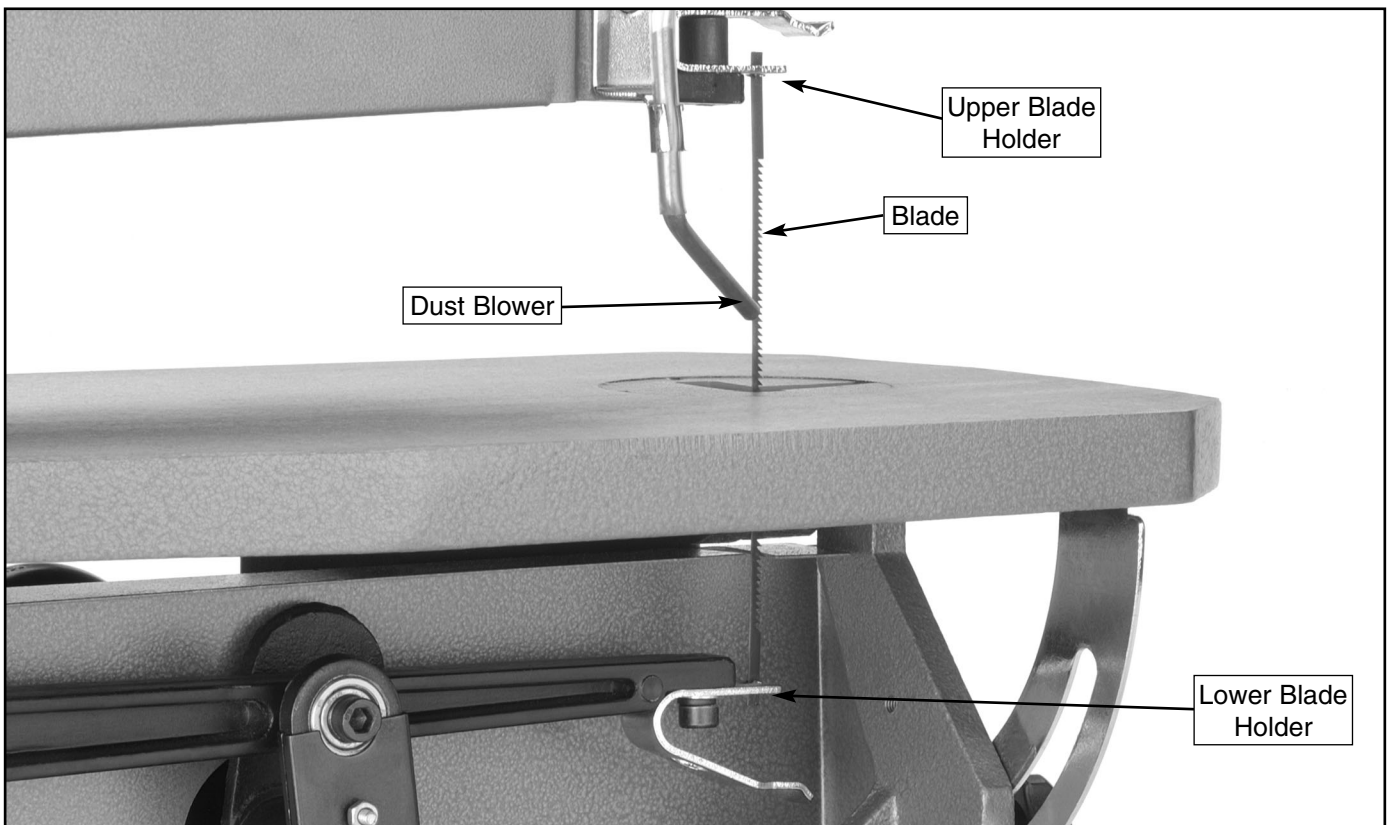
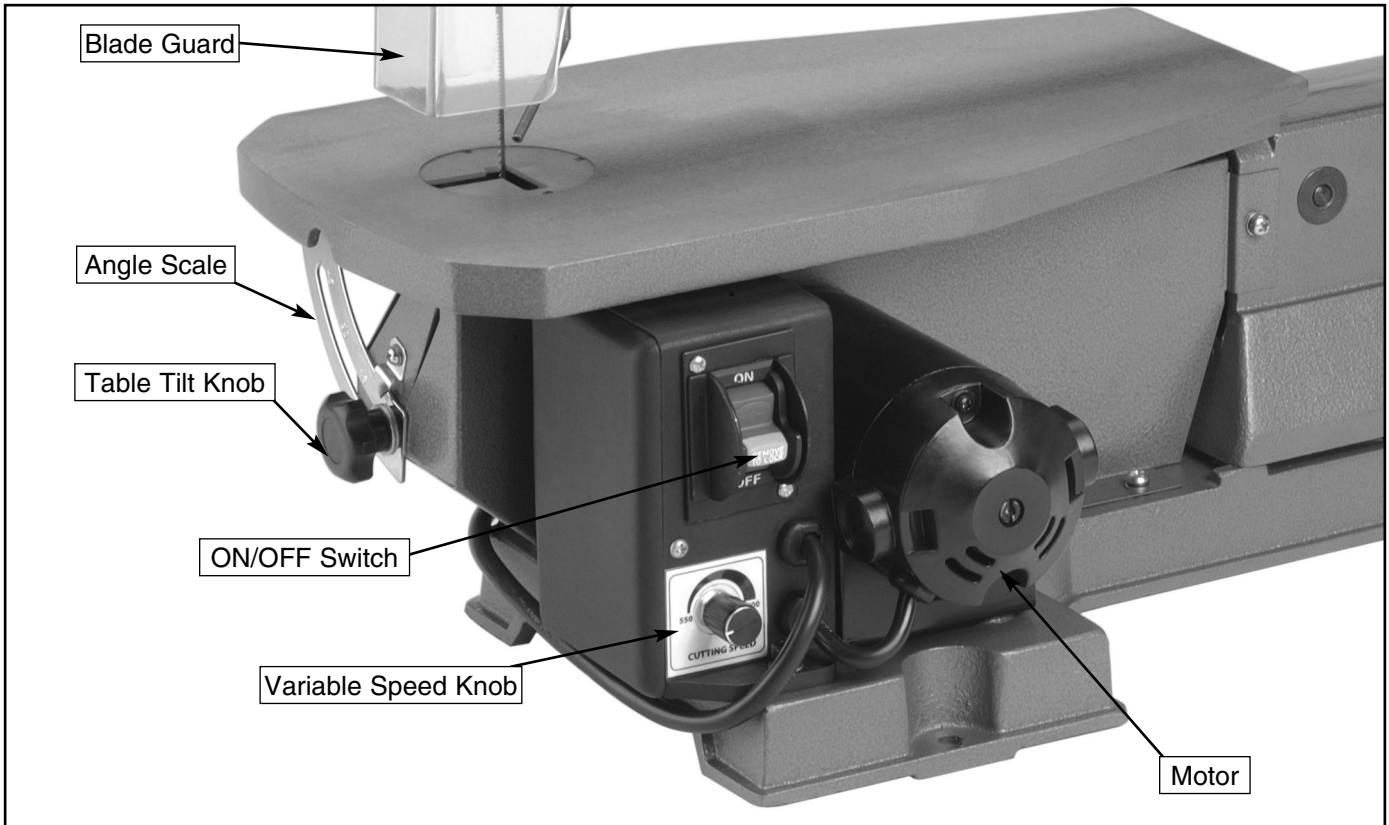



Figure 2. Machine features.

SECTION 5: SET UP

Unpacking

The machine was carefully packed when it left the Grizzly warehouse. If you discover the machine is damaged after you have signed for delivery, and the truck and driver are gone, you will need to file a freight claim with the carrier. Save the containers and all packing materials for possible inspection by the carrier or its agent. Without the packing materials, filing a freight claim can be difficult. If you need assistance determining whether you need to file a freight claim, or with the procedure to file one, please contact our Customer Service.

	<p>CAUTION Sharp edges on metal parts may cause personal injury. Examine the edges of all metal parts before handling.</p>
--	---

When you are completely satisfied with the condition of your shipment, inventory its parts.



G0536 Inventory

- A. Blade Guard1
- B. Blade1
- C. Dust Blower and Mounting Plate1
- D. Hex Bolt and Knurled Nut1

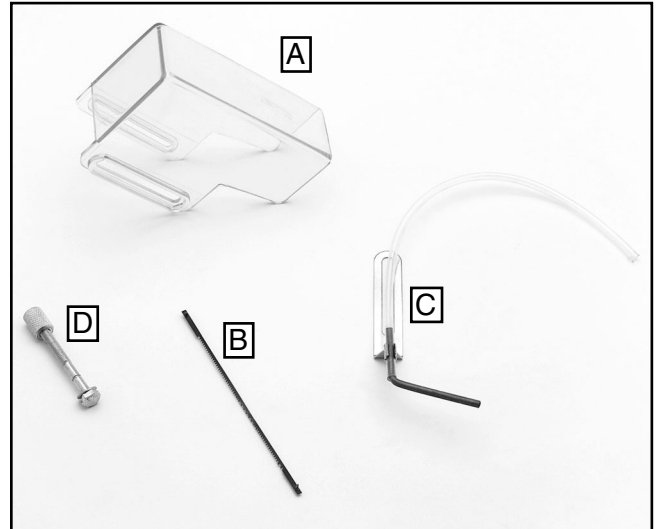

Figure 3. G0536 Inventory.



Site Considerations

Weight Load

The Model G0536 Scroll Saw is a small weight load with a small footprint. Most workbenches should be sufficient to carry the weight of the machine. Reinforce the workbench if you question its ability to support the weight.

Working Clearance

Working clearances can be thought of as the distances between machines and obstacles that allow safe operation of every machine without limitation. Consider existing and anticipated machine needs, size of material to be processed through each machine, and space for auxiliary stands or work tables. Also consider the relative position of each machine to one another for efficient material handling.

Lighting And Outlets Lighting should be bright enough to eliminate shadow and prevent eye strain. Electrical circuits should be dedicated or large enough to handle the amperage draw. Outlets should be located near each machine so power or extension cords are clear of high-traffic areas. Observe local electrical codes for proper installation of new lighting, outlets, or circuits.

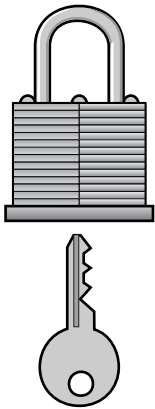
	<p>⚠️ WARNING</p> <p>Unsupervised children and visitors inside your shop could receive serious personal injury. Ensure child and visitor safety by keeping all entrances to the shop locked at all times. DO NOT allow unsupervised children or visitors in the shop at any time.</p>
---	---



Clean Up

The unpainted surfaces are coated with a waxy oil to protect them from corrosion during shipment. Remove this protective coating with a solvent cleaner or citrus-based degreaser such as Grizzly's G7895 Degreaser. To clean thoroughly, some parts may need to be removed. **For optimum performance from your machine, make sure you clean all moving parts or sliding contact surfaces that are coated.** Avoid chlorine-based solvents as they may damage painted surfaces should they come in contact.

	<p>⚠️ WARNING</p> <p>Gasoline and petroleum products have low flash points and could explode if used to clean machinery. DO NOT use gasoline or petroleum products to clean the machinery.</p>
---	--

	<p>⚠️ WARNING</p> <p>Smoking near solvents could ignite an explosion or fire and cause serious injury. DO NOT smoke while using solvents.</p>
--	---

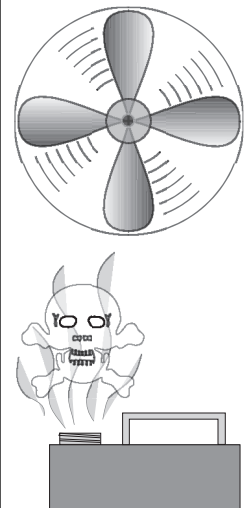
	<p>⚠️ WARNING</p> <p>Lack of ventilation while using solvents could cause serious personal health risks, fire, or environmental hazards. Always work in a well ventilated area to prevent the accumulation of dangerous fumes. Supply the work area with a constant source of fresh air.</p>
--	---



Beginning Assembly

This section covers the basic assembly and adjustment instructions needed to begin operation. Complete the assembly in the order provided in this manual and then read the remaining portion of the manual before attempting any type of operation.

Your safety is important! Please follow the warnings below during this entire section:

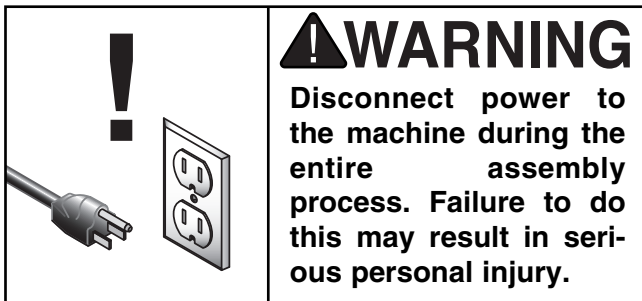
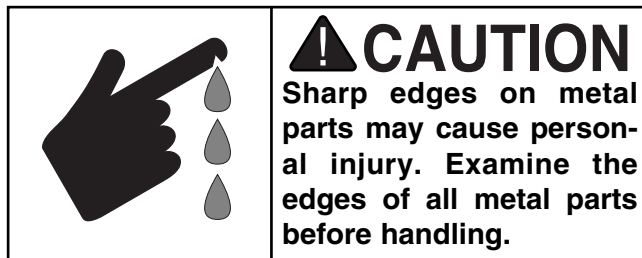

Mount Scroll Saw

To attach the scroll saw to a solid surface:

1. Locate a rectangular piece of $\frac{3}{4}$ " plywood that is at least 20"W x 16"D.
2. Mount the base of the scroll saw to the center of the plywood with $\frac{1}{4}$ " x 1" lag bolts and $\frac{1}{4}$ " washers.
3. Clamp the plywood securely to a workbench.
4. To permanently mount the scroll saw to the workbench, screw $\frac{1}{4}$ " x 1" (or longer) lag bolts with $\frac{1}{4}$ " washers directly to the workbench.



Attach Blade Guard

To attach the blade guard:

1. Set the blade guard on the scroll saw table and position it around the upper arm.
2. Thread the bolt through the blade guard components as shown in **Figure 4**, and screw it into the knurled nut.

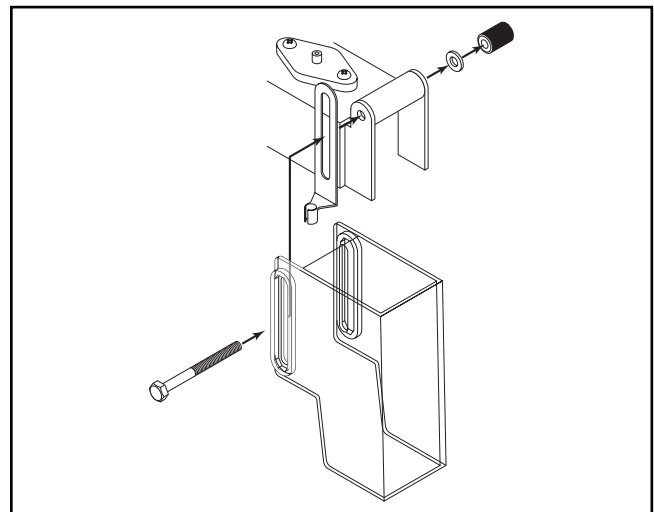

Figure 4. Blade guard assembly.

3. Adjust the dust blower mounting plate and the blade guard so that they ride just above the workpiece, and tighten the knurled nut shown in **Figure 5**.

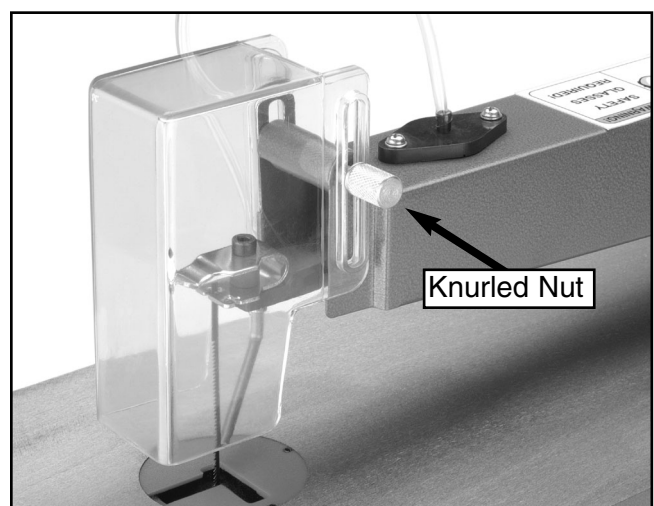

Figure 5. Blade guard adjustment.



Installing Blades

To install the blade:

1. **Disconnect the machine from the power source.**
2. Feed the blade through the table and hook into the lower blade holder as shown in **Figure 6**. The blade teeth should face forward and down.

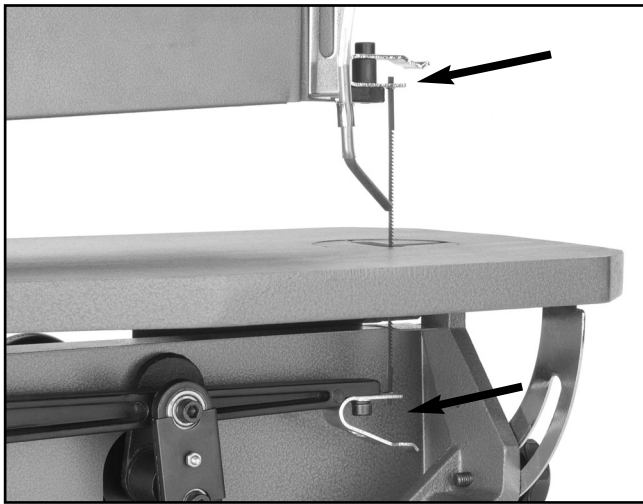

Figure 6. Blade attached to both holders.
(Guard removed for clarity)

3. Push down on the upper blade holder and slide the upper end of the blade into the holder. Make sure that the pins are seated into the grooves in both holders.
4. Increase the tension on the blade until the blade gives a musical sound when plucked.

Note—Determining correct blade tension is subjective and learned through experience. If the blade is loose, the blade will drift off the layout line when cutting and the scroll saw will be noisy and vibrate. If the blade is too tight, the blade could break causing serious injury. Properly tensioned blades will last longer and are less likely to break.

5. Replace the lower arm guard, the throat plate and lower the blade guard into position.

Note—The blade can be installed sideways to accommodate long workpieces.



Test Run

Once the assembly is complete, the machine needs to be tested. The purpose of the test run is to ensure that there are no problems.

To test run the scroll saw:

1. Remove all tools from the scroll saw.
2. Turn the variable speed setting down to 550 SPM.
3. Plug the saw into the power source. Flip the switch **ON**. Keep your finger ready to turn the scroll saw **OFF**.
4. Listen for any unusual noises, vibrations or rubbing. If anything sounds unusual, stop the saw immediately.
5. Disconnect the machine from the power source and find the source of the problem before operating further.

NOTE—If you cannot locate the source of an unusual noise or vibration, feel free to contact our service department for help.

WARNING

Before starting the saw, make sure you have performed the preceding assembly and adjustment instructions, and you have read through the rest of the manual and are familiar with the various functions and safety issues associated with this machine. Failure to follow this warning could result in serious personal injury.



SECTION 6: OPERATIONS

General

This section will cover basic scroll sawing operations. Please read the remaining portion of the manual before attempting any type of operation.

Your safety is important! Please follow the warnings below during this entire section:

!WARNING

Damage to your eyes, lungs, and ears could result from failure to wear safety glasses, a respirator, and hearing protection while using this machine.

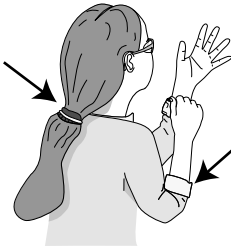
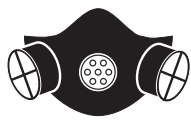

!WARNING

Loose hair and clothing could get caught in machinery and cause serious personal injury. Keep loose clothing rolled up and long hair tied up and away from machinery.



Blade Speed

It is important to adjust the blade speed for the type of material being cut. Generally harder materials require a slower blade speed.

To adjust the blade speed:

Rotate the knob, shown in **Figure 7**, clockwise to increase the blade speed, and counterclockwise to reduce the speed.

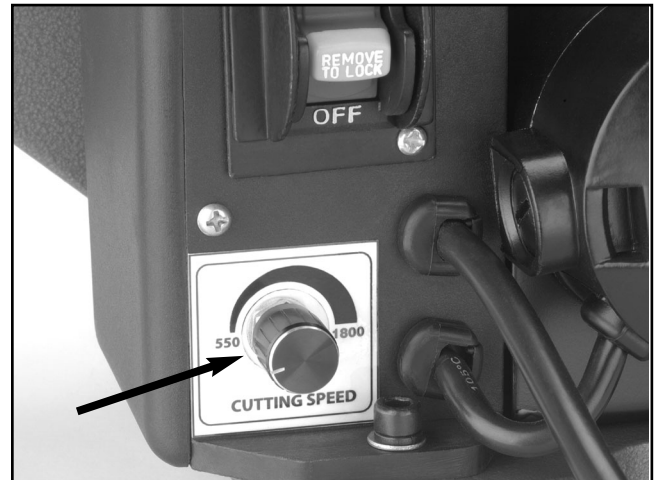

Figure 7. Variable speed knob.

Feed Rate

The feed rate is the speed an operator moves the workpiece through the saw blade. The correct feed rate depends on the type of material, and its thickness. When using the correct feed rate the workpiece will move easily and the motor will run smoothly. When feeding the work too quickly the motor may bog down and the blade can break, causing serious injury.



Changing Blades

A typical scroll saw blade will wear out in ½ to 2 hours, depending on the material cut. Blades become dull quicker when cutting thick material, plywood, laminates, hardwoods and metal.

To change the blade:

1. **Disconnect the machine from the power source**
2. Remove the throat plate and the lower arm guard shown in **Figure 8**.

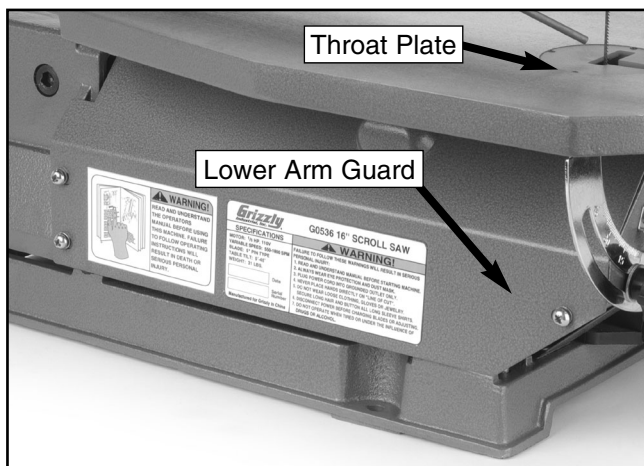

Figure 8. Arm guard screws and throat plate.

3. Loosen the blade tension adjustment knob.
4. Push down on the upper blade holder shown in **Figure 9**, pull the upper end of blade out of the holder, push down on the blade to free the lower end of the blade, and pull the blade up to remove.

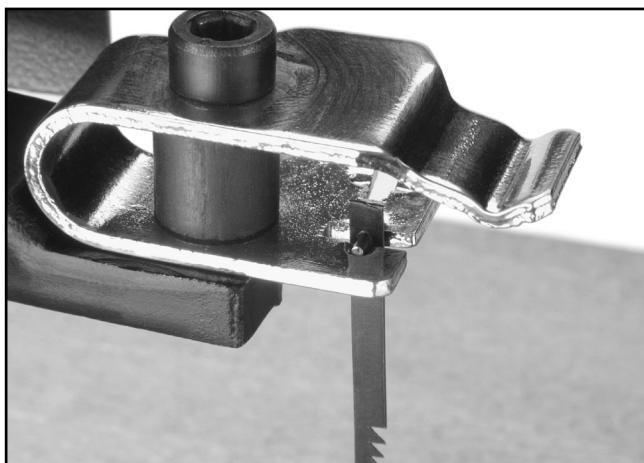

Figure 9. Upper blade holder.

5. Feed the blade through the table and hook it into the lower blade holder as shown in **Figure 10**. The teeth should face forward and down.

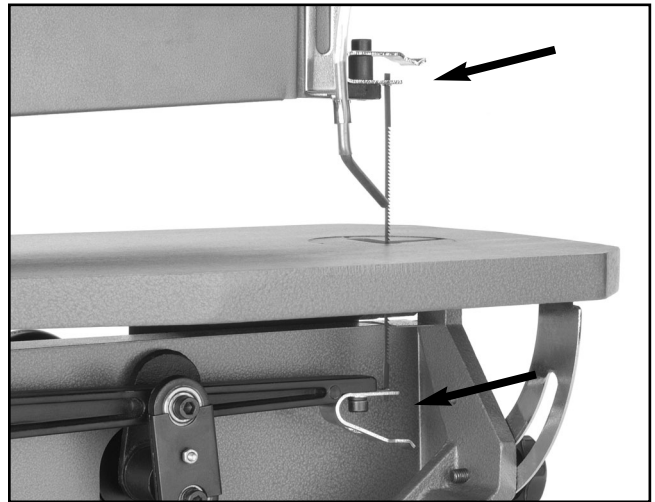

Figure 10. Blade attached to both holders.
(Guard removed for clarity)

6. Push down on the upper blade holder and slide the upper end of the blade into the holder. Make sure that the pins are seated into the grooves in both holders.
7. Increase the tension on the blade until the blade gives a musical sound when plucked.

Note—Determining correct blade tension is subjective and is learned through experience. If the blade is not tensioned enough the blade will drift off the layout line when cutting. The scroll saw will also have excessive noise and vibration. If the blade is too tight the blade could break, causing serious injury. Blades that are tensioned correctly will last longer and be less likely to break.

8. Replace the lower arm guard and the throat plate, and lower the blade guard into position.

Note—The blades can also be installed with the teeth pointing sideways to accommodate long workpieces.



Straight Cuts

Miter gauges and fences are not effective on scroll saws because most scroll saw blades are narrow and tend to follow the grain of the wood. Freehand cutting allows the operator to compensate for blade drift.

To make a straight cut:

1. Draw a straight line on your workpiece.
2. Turn the power *ON* and allow the motor to reach full speed.
3. Feed the workpiece slowly and steadily into the blade, keeping your hands to either side of the cutting line while pushing down. Make sure the blade is cutting on the waste side of the line (**Figure 11**).



Figure 11. Straight cut.

4. Scroll saw blades will have a tendency to drift. Compensate by adjusting the feed direction.

Note—The variation of hard and soft grain in wood will cause the scroll saw blade to deflect. If you are approaching hard grain at an angle, the feed rate must be slowed and pressure should be applied toward the side with the hard grain.



Curved Cuts

When cutting curves, preplan your cut and leave tight inside curves for a second pass to minimize backing out. Cut sharp outside curves by cutting past the curve and looping around to cut from a different angle.

To make a curved cut:

1. Draw a pattern on your workpiece.
2. Choose a blade size based on the tightest curve in the workpiece. Smaller blades can cut tighter curves.
3. Rough cut the board down to a workable size.
4. Feed the workpiece into the blade with a slow and even pressure. Use your fingers to hold it down and use your thumbs to steer as shown in **Figure 12**.

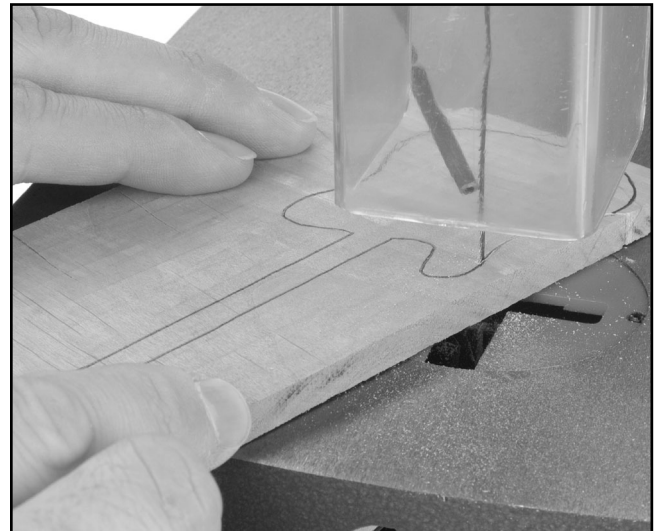

Figure 12. Making a curved cut.

Note—When approaching a tight radius, slow down your feed rate, but don't stop. Give the teeth time to make the cut. Forcing the workpiece through the curve will cause the blade to twist or break. If your cut produces waste in the curve's interior, turn the power off and wait until all motion stops before removing the waste.



Inside Cuts

Inside cuts such as circles or the insides of closed letters can be easily cut with your scroll saw by threading the blade through a hole drilled in the workpiece.

To make an inside cut:

1. **Disconnect the machine from the power source.**
2. Remove blade and throat plate.
3. Drill a hole in the waste portion of the workpiece that is large enough for the pins to fit through.
4. Thread the blade through the hole in the workpiece as shown in **Figure 13**.

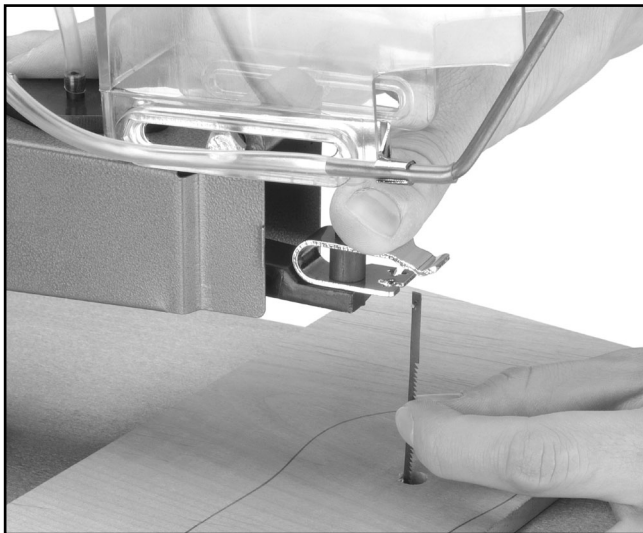

Figure 13. Installing the blade for an inside cut.

5. Replace the throat plate, mount the blade and tension it.
6. Make the inside cut and go back to **step 1** for the next inside cut.



Bevel Cuts

Bevel cuts can be used for miters, cope joints, and making relief or recessed projects.

To make a bevel cut:

1. Draw your pattern as described in the previous sections.
2. Adjust the table to the desired angle.
3. Using the same principles as in the previous sections, feed the work slowly and evenly into the blade, remembering not to force the workpiece (**Figure 14**).

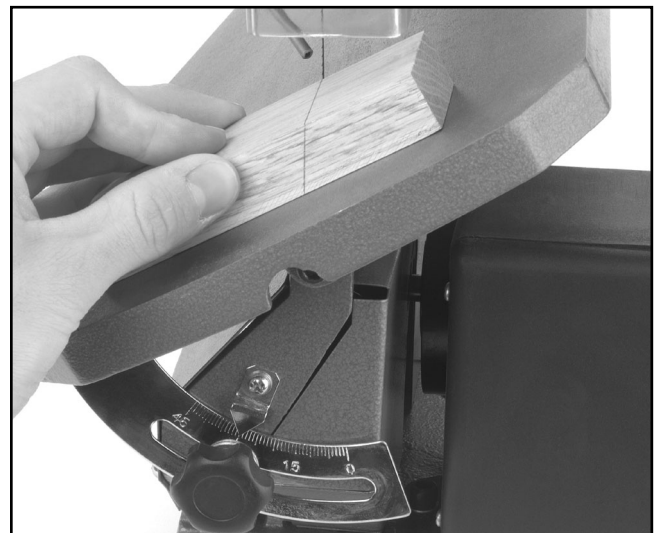

Figure 14. Making a bevel cut.

4. Wait until all motion has stopped before removing waste near the blade.





SECTION 7: MAINTENANCE

Maintenance Safety

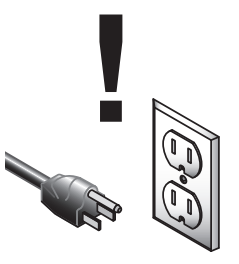
Your safety is important! Please follow the warnings below during this entire section:

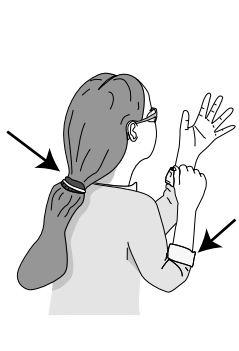
	<p>! WARNING</p> <p>Always disconnect power to the machine before performing maintenance. Failure to do this may result in serious personal injury.</p>
---	--

	<p>! WARNING</p> <p>Loose hair and clothing could get caught in machinery and cause serious personal injury. Keep loose clothing rolled up and long hair tied up and away from machinery.</p>
--	--

	<p>! WARNING</p> <p>Projectiles from the machine could cause serious eye injury. Wear safety glasses at all times.</p>
---	---



General

Regular periodic maintenance on the Model G0536 will ensure optimum performance. Make a habit of inspecting the machine each time you use it.

Before each use, look for the following conditions:

1. Loose bolts.
2. Damaged blades.
3. Worn switch.
4. Worn or damaged cords and plugs.
5. Any other condition that could hamper the safe operation of this machine.



Working Table

The table and other non-painted surfaces on your machine should be protected against rust and pitting. Wiping the table clean after every use ensures that moisture from wood dust does not remain on bare metal surfaces.

Tables can be kept rust-free with regular applications of products like SLIPIT® or Boeshield® T-9. For long term storage you may want to consider products like Kleen Bore's Rust Guardit™.



Lubrication

Lubricate the upper and lower arm bushings with light machine oil once a month or after 50 hours of use.

To lubricate the bushings:

1. **Disconnect the machine from the power source.**
2. Remove the upper arm guard.
3. Lay the machine on its side.
4. Apply a generous amount of machine oil to the end of the bolts that hold the bushings in place as shown in **Figure 15**.

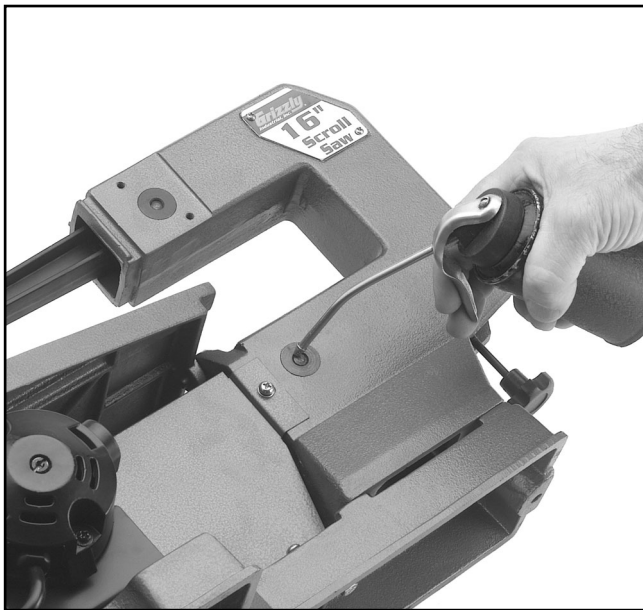

Figure 15. Lubricating bushings.

5. Leave the scroll saw on its side and allow the machine oil to soak in overnight.



Replacing Brushes

Replacing the motor brushes is a simple job that may be necessary after extended use.

To replace the motor brushes:

1. **Disconnect the machine from the power source.**
2. Remove the motor brush caps with a flat-head screwdriver. One of the caps is shown in **Figure 16**. The other is on the opposite side of the motor.

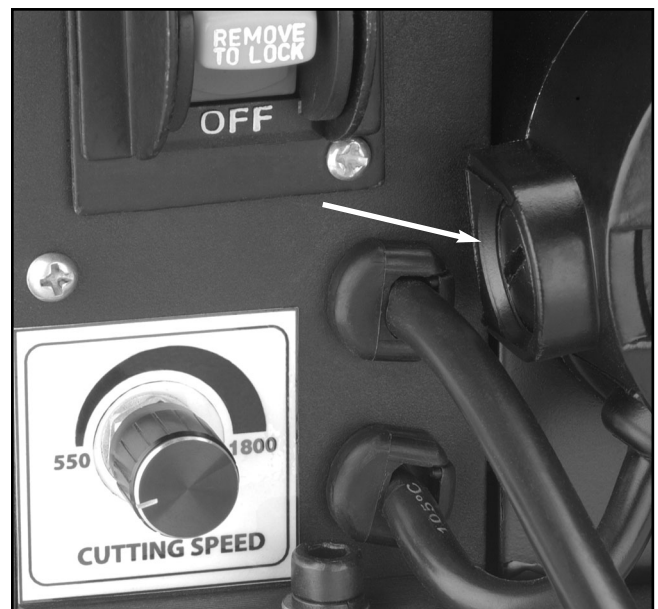
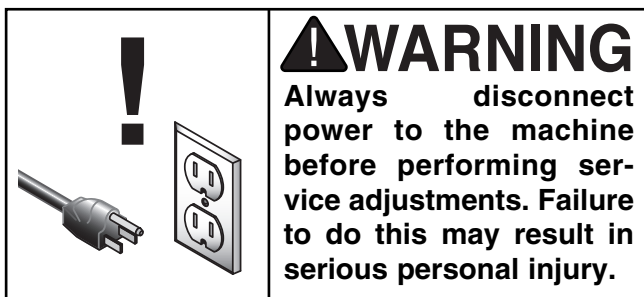

Figure 16. Motor brush cap.

3. Remove the brushes and check for black carbon build-up or damage. If necessary, replace the brushes.
4. Slide brushes back into the slot and replace the brush caps.



SECTION 8: SERVICE ADJUSTMENTS



About Service

This section is designed to help the operator with adjustments that were made at the factory and that might also need to be made during the life of the machine.

This section is provided for your convenience—it is not a substitute for the Grizzly Service Department. If any adjustments arise that are not described in this manual, then feel free to call the Grizzly Service Department at (570) 546-9663.

Similarly, if you are unsure of how to perform any procedure in this section, the Grizzly Service Department will be happy to guide you through the procedures or help in any other way.



Squaring Table

To ensure that the table is square:

1. Disconnect the machine from the power source.
2. Loosen the table tilt knob shown in **Figure 17**.

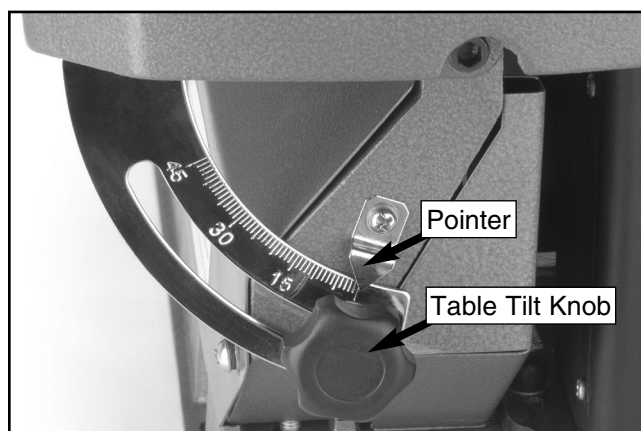

Figure 17. Pointer and table tilt knob.

3. Place a square on the table and against the blade as shown in **Figure 18**.

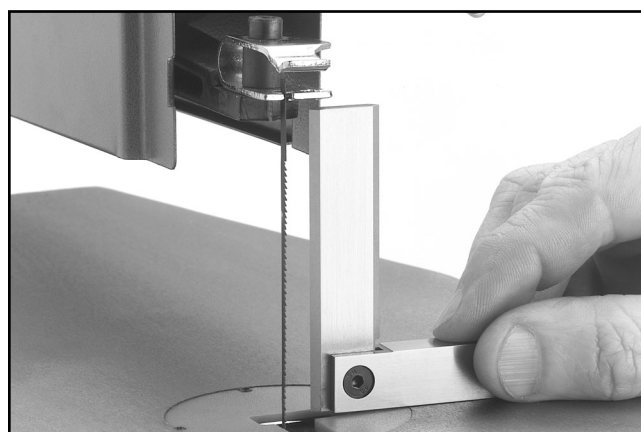

Figure 18. Check the angle with a square

4. Adjust the table until there is no space between the square and the blade.
5. Tighten the table tilt knob, loosen the pointer shown in **Figure 17** and adjust it to 0°.



SECTION 9: REFERENCE INFO

General

This section contains the following subsections for the Model G0536: aftermarket accessories, data sheets, parts diagrams and list, troubleshooting, and warranty/return information.

If you need parts or help in assembling your machine, or if you need operational information, call the service department at (570) 546-9663. Trained service technicians will be glad to help you.

If you have any comments regarding this manual, please write to Grizzly at the address below:

Grizzly Industrial, Inc.
c/o Technical Documentation
P.O. Box 2069
Bellingham, WA 98227-2069

We recommend you keep a copy of our current catalog for complete information regarding Grizzly's warranty and return policy. If you need additional technical information relating to this machine, or if you need general assistance or replacement parts, please contact the Service Department at the location listed below.

Grizzly Industrial, Inc.
1203 Lycoming Mall Circle
Muncy, PA 17756
Phone: (570) 546-9663
Fax: (800) 438-5901
E-Mail: techsupport@grizzly.com
Web Site: <http://www.grizzly.com>



Aftermarket Accessories

To order any of the aftermarket accessories below, find the model number in bold and call our customer service line 24 hours a day at 1-800-523-4777.

Replacement Blades:

MODEL	#	WIDTH	TPI	TOOTH
G6670	0.008	0.078"	25	Skip
G6671	0.019	0.125"	10	Skip
G6672	0.018	0.110"	15	Skip

Scroll Saw Abrasive Packs:

Quickly smooths edges of wood, plastic, metal and composite scroll saw projects. Eliminate hand sanding. 1/2" grits are 80, 120, 180 & 220. 1/4" grits are 120, 180, 220 & 320. Packs of 4.

MODEL	TYPE	WIDTH
H5323	Pin	1/2"
H5324	Pin	1/4"



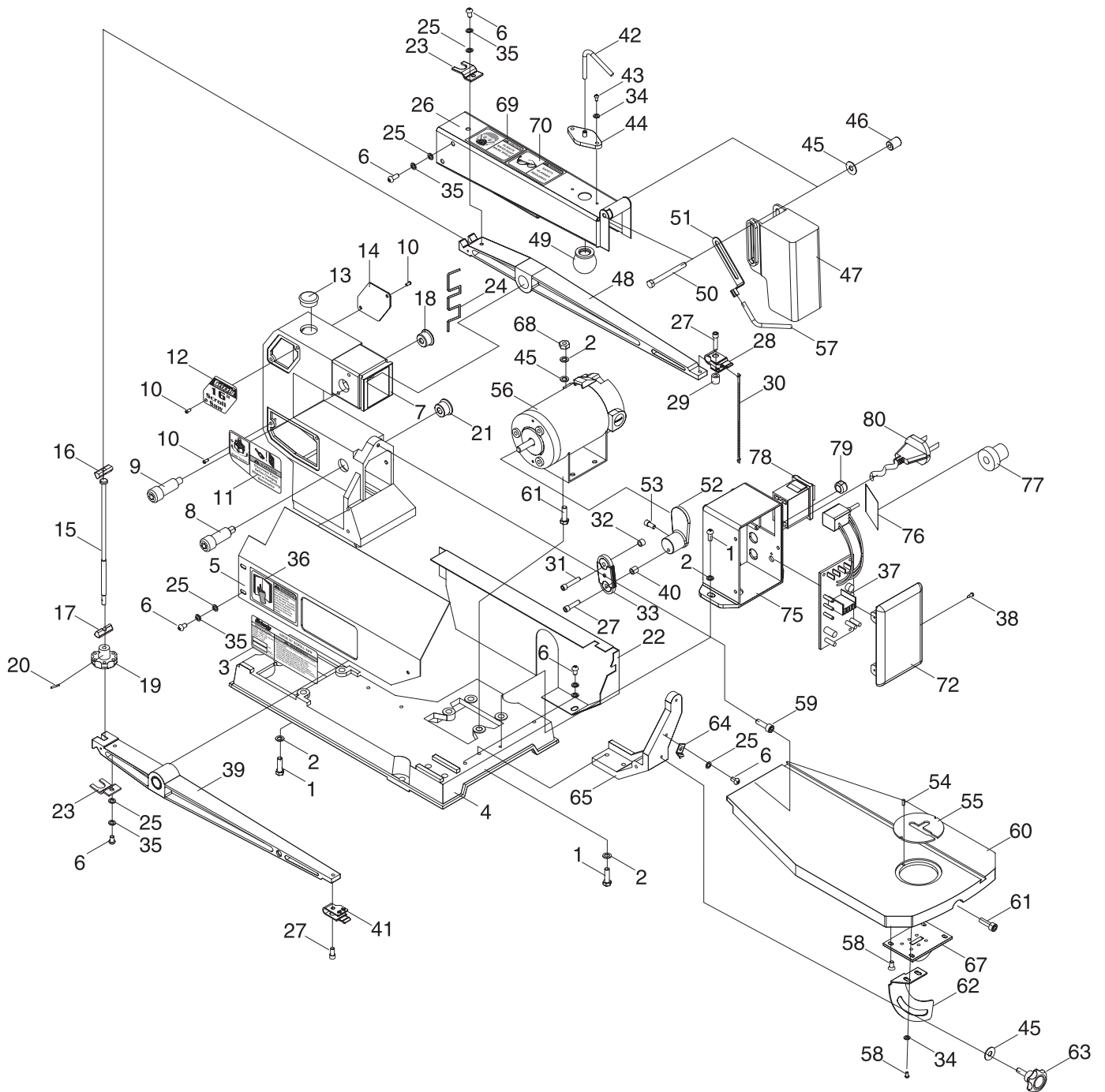

REF	PART #	DESCRIPTION
1	PB10M	Hex Bolt M6-1 x 25
2	PLW03M	Lock Washer 6mm
3	P0536003	Warning ID Label
4	P0536004	Lower Base
5	P0536005	Left Cover
6	PS09M	Phlp Hd Scr M5-.8 x 10
7	P0536007	Pillar Body
8	P0536008	Pin Shaft
9	P0536009	Pin Shaft
10	PS12M	Phlp Hd Scr M3-.5 X 6
11	P0536011	Unplug Warning
12	P0536012	Left Side Nameplate
13	P0536013	Plastic Cap
14	P0536014	Right Side Nameplate
15	P0536015	Screw Pole
16	P0536016	Expand Block
17	P0536017	Expand Block
18	P0536018	Bushing
19	P0536019	Blade Tension Knob (Female)
20	P0536020	Columned Pin
21	P0536021	Bushing
22	P0536022	Right Cover
23	P0536023	Pressure Plate
24	P0536024	Spring
25	PW02M	Flat Washer 5mm
26	P0536026	Upper Arm Guard
27	PSB81M	Cap Screw M5-.8 x 20
28	P0536028	Upper Blade Clip
29	P0536029	Spacer
30	P0536030	Blade
31	PSB95M	Cap Screw M5-.8 x 30
32	P0536032	Spacer
33	P0536033	Connecting Link
34	PW05M	Flat Washer 4mm
35	PLW01M	Lock Washer 5mm
36	P0536036	Read Manual Warning
37	P0536037	Circuit Board
38	PHTEK5M	Self-Tapping Screw M4-.7 x 12

REF	PART #	DESCRIPTION
39	P0536039	Lower Arm
40	P0536040	Spacer
41	P0536041	Lower Blade Clip
42	P0536042	Air Hose
43	PS38M	Phlp Hd Scr M4-.7 x 10
44	P0536044	Pressure Plate
45	PW03M	Flat Washer 6mm
46	P0536046	Knurled Nut 6mm
47	P0536047	Eye Guard
48	P0536048	Upper Arm
49	P0536049	Air Bellows
50	PB119M	Hex Bolt M6-1 x 60
51	P0536051	Retainer
52	P0536052	Rocker Arm
53	PSB26M	Cap Screw M6-1 x 12
54	PRP15M	Roll Pin 3mm x 8mm
55	P0536055	Table Insert
56	P0536056	Motor
57	P0536057	Dust Blower
58	PFH19M	Flat Head Screw M4-.7 x 10
59	P0536059	Axle Bolt M6-1
60	P0536060	Table
61	PSB02M	Cap Screw M6-1 x 20
62	P0536062	Table Tilt Scale
63	P0536063	Locking Knob M6-1 x 20
64	P0536064	Pointer
65	P0536065	Front Strut
67	P0536067	Lower Protection Guard
68	PN01M	Hex Nut M6-1
69	P0536069	Dust Mask Warning
70	P0536070	Safety Glasses Warning
72	P0536072	Switch Box Panel
75	P0536075	Switch Box
76	P0536076	Variable Speed Label
77	P0536077	Variable Speed Knob & Panel
78	P0536078	On/Off Switch
79	P0536079	Strain Relief
80	P0536080	Cord & Plug



MACHINE DATA SHEET

Customer Service #: (570) 546-9663 • To Order Call: (800) 523-4777 • Fax #: (800) 438-5901

GRIZZLY MODEL G0536 16" SCROLL SAW

Design Type Bench Model

Overall Dimensions:

Table14 $\frac{3}{8}$ " x 7 $\frac{7}{8}$ "
Overall Height.....11 $\frac{3}{4}$ "
Width.....10 $\frac{1}{2}$ "
Depth21"
Box Size23" x 11" x 13"
Shipping Weight34 lbs.
Net Weight31 lbs.
Footprint15 $\frac{1}{4}$ " x 8 $\frac{3}{8}$ "

Capacities:

Depth of Throat16"
Maximum Cutting Height @90°2 $\frac{1}{8}$ "
Maximum Cutting Height @45°1"
Table Tilt0-45°

Blade and Movement:

Blade5" Pin-Type
Strokes per minuteVariable; 550 – 1800 SPM
Stroke $\frac{1}{2}$ "

Construction:

BaseCast Iron
TableCast Iron
ArmsAluminum

Motor:

TypeUniversal
Horsepower $\frac{1}{8}$ HP
Amps1.4A
Phase / VoltageSingle Phase / 110V
Cycle / RPM60 Hertz / Variable; 550 – 1800 RPM
Switch.....Toggle ON/OFF; Rotary Speed Control
Power TransferDirect Drive, Counterbalanced Flywheel
BearingsShielded & Lubricated Ball Bearings

Features:

.....Clear Blade Guard
.....Adjustable Dust Blower
.....Blade Tension Adjustment Knob

Specifications, while deemed accurate, are not guaranteed.

REVISED 10/03

Troubleshooting Guide

SYMPTOM	POSSIBLE CAUSE	CORRECTIVE ACTION
Blade won't stay on layout line.	1. Blade not tensioned enough.	1. Increase tension on blade.
Excessive blade breakage.	1. Blade tensioned too much. 2. Upper and lower blade guides are not perfectly in line.	1. Loosen blade tension. 2. Loosen guides and line them up.
Motor will not start.	1. Low voltage. 2. Open circuit in motor or loose connections.	1. Check power line for proper voltage. 2. Inspect all lead connections on motor for loose or open connections.
Motor will not start; fuses or circuit breakers blow.	1. Short circuit in line cord or plug. 2. Short circuit in motor or loose connections. 3. Incorrect fuses or circuit breakers in power line.	1. Inspect cord or plug for damaged insulation and shorted wires. 2. Inspect all connections on motor for loose or shorted terminals or worn insulation. 3. Install correct fuses or circuit breakers.
Motor overheats.	1. Motor overloaded. 2. Air circulation through the motor restricted.	1. Reduce load on motor. 2. Clean out motor to provide normal air circulation.
Motor stalls (resulting in blown fuses or tripped circuit).	1. Short circuit in motor or loose connections. 2. Low voltage. 3. Incorrect fuses or circuit breakers in power line. 4. Motor overloaded.	1. Inspect connections on motor for loose or shorted terminals or worn insulation. 2. Correct the low voltage conditions. 3. Install correct fuses or circuit breakers. 4. Reduce load on motor.
Machine slows or stalls when operating.	1. Applying too much pressure to workpiece. 2. Badly worn motor brushes.	1. Feed workpiece slower. 2. Replace motor brushes.

Warranty & Returns

Grizzly Industrial, Inc. warrants every product it sells for a period of **1 year** to the original purchaser from the date of purchase. This warranty does not apply to defects due directly or indirectly to misuse, abuse, negligence, accidents, repairs or alterations or lack of maintenance. This is Grizzly's sole written warranty and any and all warranties that may be implied by law, including any merchantability or fitness, for any particular purpose, are hereby limited to the duration of this written warranty. We do not warrant or represent that the merchandise complies with the provisions of any law or acts unless the manufacturer so warrants. In no event shall Grizzly's liability under this warranty exceed the purchase price paid for the product and any legal actions brought against Grizzly shall be tried in the State of Washington, County of Whatcom.

We shall in no event be liable for death, injuries to persons or property or for incidental, contingent, special, or consequential damages arising from the use of our products.

To take advantage of this warranty, contact us by mail or phone and give us all the details. We will then issue you a "Return Number," which must be clearly posted on the outside as well as the inside of the carton. We will not accept any item back without this number. Proof of purchase must accompany the merchandise.

The manufacturers reserve the right to change specifications at any time because they constantly strive to achieve better quality equipment. We make every effort to ensure that our products meet high quality and durability standards and we hope you never need to use this warranty.

Please feel free to write or call us if you have any questions about the machine or the manual.

Thank you again for your business and continued support. We hope to serve you again soon.



WARRANTY CARD

Name _____
Street _____
City _____ State _____ Zip _____
Phone Number _____ E-Mail _____ FAX _____
MODEL # _____ Serial # _____ Order # _____

The following information is given on a voluntary basis. It will be used for marketing purposes to help us develop better products and services. Of course, all information is strictly confidential.

1. How did you learn about us?
- Advertisement Friend
 Catalog Card Deck
 World Wide Web
 Other _____
2. Which of the following magazines do you subscribe to.
- American Woodworker Practical Homeowner
 Cabinetmaker Shop Notes
 Family Handyman Today's Homeowner
 Fine Homebuilding WOOD
 Fine Woodworking Wooden Boat
 Home Handyman Woodshop News
 Journal of Light Construction Woodsmith
 Old House Journal Woodwork
 Popular Mechanics Woodworker
 Popular Science Woodworker's Journal
 Popular Woodworking Workbench
 Other _____
3. Which of the following woodworking/remodeling shows do you watch?
- Backyard America The New Yankee Workshop
 Home Time This Old House
 The American Woodworker Woodwright's Shop
 Other _____
4. What is your annual household income?
- \$20,000-\$29,999 \$60,000-\$69,999
 \$30,000-\$39,999 \$70,000-\$79,999
 \$40,000-\$49,999 \$80,000-\$89,999
 \$50,000-\$59,999 \$90,000 +
5. What is your age group?
- 20-29 50-59
 30-39 60-69
 40-49 70 +
6. How long have you been a woodworker?
- 0 - 2 Years 8 - 20 Years
 2 - 8 Years 20+ Years
7. How would you rank your woodworking skills?
- Simple Advanced
 Intermediate Master Craftsman
8. What stationary woodworking tools do you own? Check all that apply.
- Air Compressor Panel Saw
 Bandsaw Planer
 Drill Press Power Feeder
 Drum Sander Radial Arm Saw
 Dust Collector Shaper
 Horizontal Boring Machine Spindle Sander
 Jointer jointer
 Lathe Vacuum Veneer Press
 Mortiser Wide Belt Sander
 Other _____
9. How many of your woodworking machines are Grizzly? _____
10. Which benchtop tools do you own? Check all that apply.
- 1" x 42" Belt Sander 6" - 8" Grinder
 5" - 8" Drill Press Mini Lathe
 8" jointer 10" - 12" Thickness Planer
 8" - 10" Bandsaw Scroll Saw
 Disc/Belt Sander Spindle/Belt Sander
 Mini Jointer
 Other _____
11. How many of the machines checked above are Grizzly? _____
12. Which portable/hand held power tools do you own? Check all that apply.
- Belt Sander Orbital Sander
 Biscuit Joiner Palm Sander
 Circular Saw Portable Planer
 Detail Sander Saber Saw
 Drill/Driver Reciprocating Saw
 Miter Saw Router
 Other _____
13. What machines/supplies would you like Grizzly Industrial to carry?

14. What new accessories would you like Grizzly Industrial to carry?

15. What other companies do you purchase your tools and supplies from?

16. Do you think your purchase represents good value?
 Yes No
17. Would you recommend Grizzly Industrial to a friend?
 Yes No
18. Would you allow us to use your name as a reference for Grizzly customers in your area? **Note: We never use names more than three times.**
 Yes No
19. Comments: _____

CUT ALONG DOTTED LINE

FOLD ALONG DOTTED LINE



Place
Stamp
Here



GRIZZLY INDUSTRIAL, INC.
P.O. BOX 2069
BELLINGHAM, WA 98227-2069



FOLD ALONG DOTTED LINE

Send a Grizzly Catalog to a friend:

Name _____
Street _____
City _____ State _____ Zip _____

TAPE ALONG EDGES--PLEASE DO NOT STAPLE

grizzly.com

TOOL WEBSITE

Buy Direct and Save with Grizzly® – Trusted, Proven and a Great Value!

*Visit Our Website Today And Discover Why
Grizzly® Is The Industry Leader!*

- SECURE ORDERING
- ORDERS SHIPPED WITHIN 24 HOURS
- E-MAIL RESPONSE WITHIN ONE HOUR

-OR-

Call Today For A **FREE**
Full Color Catalog

1-800-523-4777



Free Manuals Download Website

<http://myh66.com>

<http://usermanuals.us>

<http://www.somanuals.com>

<http://www.4manuals.cc>

<http://www.manual-lib.com>

<http://www.404manual.com>

<http://www.luxmanual.com>

<http://aubethermostatmanual.com>

Golf course search by state

<http://golfingnear.com>

Email search by domain

<http://emailbydomain.com>

Auto manuals search

<http://auto.somanuals.com>

TV manuals search

<http://tv.somanuals.com>