

Grizzly *Industrial, Inc.*®

MEAT CUTTING BANDSAW MODEL H6246 INSTRUCTION MANUAL



COPYRIGHT © SEPTEMBER, 2004 BY GRIZZLY INDUSTRIAL, INC.
**WARNING: NO PORTION OF THIS MANUAL MAY BE REPRODUCED IN ANY SHAPE
OR FORM WITHOUT THE WRITTEN APPROVAL OF GRIZZLY INDUSTRIAL, INC.**
CA6566 PRINTED IN CHINA

Table of Contents

INTRODUCTION	2
Foreword	2
Contact Info	2
Data Sheet	3
Identification	4
SECTION 1: SAFETY	5
Safety Instructions for Machinery.....	5
Additional Safety Instructions for Meat Saws	7
SECTION 2: CIRCUIT REQUIREMENTS	8
110V Operation	8
SECTION 3: SET UP	9
Set Up Safety.....	9
Items Needed for Set Up	9
Unpacking	9
Inventory.....	10
Hardware Recognition Chart.....	11
Clean Up	12
Site Considerations	12
Legs.....	13
Tensioning Blade	13
Blade Tracking	14
Adjusting Support Bearings.....	15
Adjusting Blade Guides.....	15
Table	16
Fences.....	18
Meat Grinder	19
Test Run.....	19
SECTION 4: OPERATIONS	20
Operation Safety	20
Key Switch	20
Guide Post	21
Changing Blades.....	21
Cutting Meat.....	22
Grinding Meat.....	22
SECTION 5: SANITIZATION	23
Cleaning the Saw	23
Proper Sanitation	24
SECTION 6: ACCESSORIES	25
SECTION 7: MAINTENANCE	26
Schedule	26
Table & Blade.....	26
V-Belt.....	26
Lubrication.....	26
H6246 Wiring Diagram.....	27
H6246 Parts Breakdown	28
H6246 Parts List.....	31
Troubleshooting.....	33
WARRANTY AND RETURNS	34

INTRODUCTION

Foreword

We are proud to offer the Model H6246 Meat Cutting Bandsaw. This machine is part of a growing Grizzly family of fine machinery. When used according to the guidelines set forth in this manual, you can expect years of trouble-free, enjoyable operation and proof of Grizzly's commitment to customer satisfaction.

We are pleased to provide this manual with the Model H6246. It was written to guide you through assembly, review safety considerations, and cover general operating procedures. It represents our effort to produce the best documentation possible.

The specifications, drawings, and photographs illustrated in this manual represent the Model H6246 as supplied when the manual was prepared. However, owing to Grizzly's policy of continuous improvement, changes may be made at any time with no obligation on the part of Grizzly. For your convenience, we always keep current Grizzly manuals available on our website at www.grizzly.com. Any updates to your machine will be reflected in these manuals as soon as they are complete. Visit our site often to check for the latest updates to this manual!



Contact Info

If you have any comments regarding this manual, please write to us at the address below:

Grizzly Industrial, Inc.
c/o Technical Documentation
P.O. Box 2069
Bellingham, WA 98227-2069

We stand behind our machines. If you have any service questions or parts requests, please call or write us at the location listed below.

Grizzly Industrial, Inc.
1203 Lycoming Mall Circle
Muncy, PA 17756
Phone: (570) 546-9663
Fax: (800) 438-5901
E-Mail: techsupport@grizzly.com
Web Site: <http://www.grizzly.com>





MODEL H6246 MEAT-CUTTING BANDSAW

Design Type Floor Model

Overall Dimensions:

Table 22³/₈" L x 17¹/₄"
Height 57¹/₂"
Width of Unit 21"
Shipping Weight 167 lbs.
Weight in Place 154 lbs.
Box Size 39" x 19" x 17"
Footprint 16¹/₂" x 19"

Cutting Capacity:

Height 8¹/₂"
Throat 9¹/₄"
Blade Length 76¹/₈"
Blade Speed 970 FPM
Range of Table Slide Movement (with fence) 8¹/₂"
Max Width of Cut of Table Slide Movement (with fence) 8¹/₄"
Fence Adjustment 8¹/₄"
Sausage Grinder Speed 300 RPM

Construction:

Table Stainless Steel
Wheels Die-Cast Aluminum
Fence Die-Cast Aluminum
Wheel Covers Pre-Formed Steel
Guides Ball Bearing Guides and Supports

Motor:

Type TEFC Capacitor Start Induction
Horsepower ³/₄ HP
Phase/ Cycle Single Phase / 60Hz
Voltage 110V
Amps 5A
RPM 1725 RPM
Bearings Shielded & Permanently Lubricated Ball Bearings
Switch Toggle Safety Switch

Features:

..... ⁵/₈" Blade, Meat Grinder and Sausage Stuffer
..... Sliding Table (Ball Bearing Support)

Specifications, while deemed accurate, are not guaranteed.

8/2004

Identification

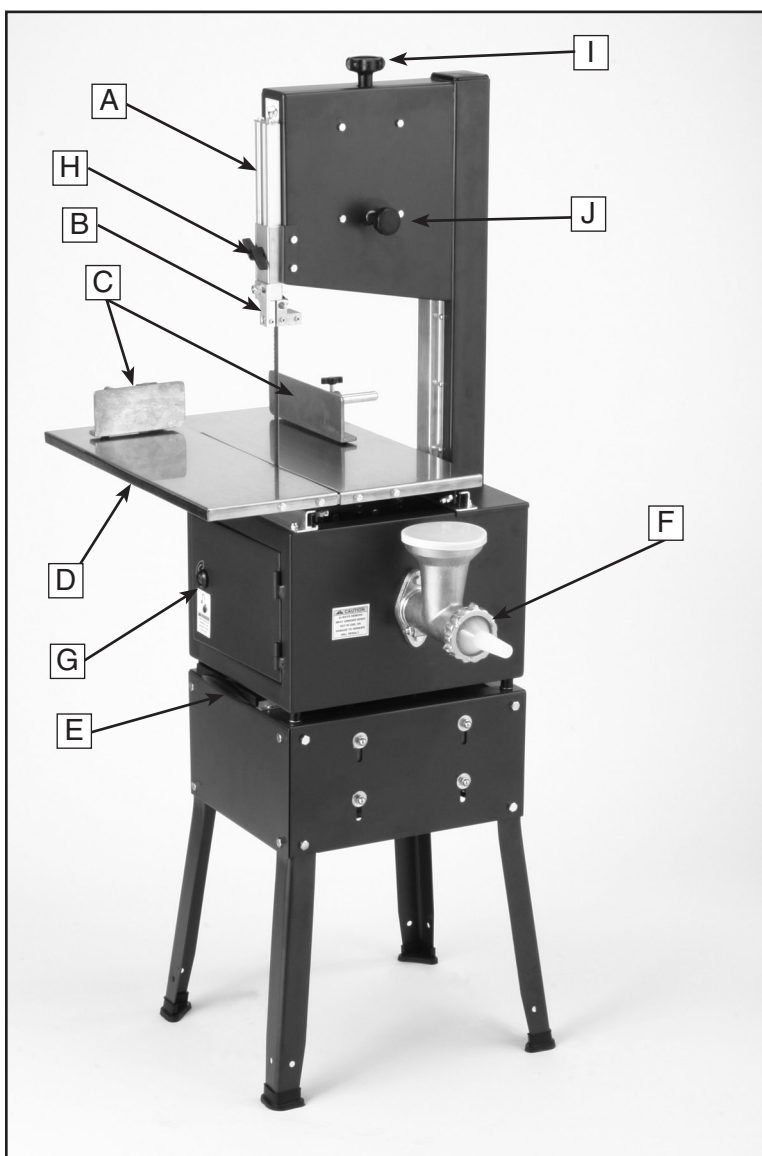

Figure 1. Feature identification.

- A.** Guide Post
- B.** Blade Guide Assembly
- C.** Cutting Fences
- D.** Sliding Table
- E.** Blood Tray
- F.** Meat Grinder/Sausage Stuffer
- G.** Access Door
- H.** Guide Post Lock Knob
- I.** Tension Knob
- J.** Tracking Control Knob



SECTION 1: SAFETY

WARNING

For Your Own Safety, Read Instruction Manual Before Operating this Machine

The purpose of safety symbols is to attract your attention to possible hazardous conditions. This manual uses a series of symbols and signal words which are intended to convey the level of importance of the safety messages. The progression of symbols is described below. Remember that safety messages by themselves do not eliminate danger and are not a substitute for proper accident prevention measures.

 **DANGER** Indicates an imminently hazardous situation which, if not avoided, WILL result in death or serious injury.

 **WARNING** Indicates a potentially hazardous situation which, if not avoided, COULD result in death or serious injury.

 **CAUTION** Indicates a potentially hazardous situation which, if not avoided, MAY result in minor or moderate injury. It may also be used to alert against unsafe practices.

NOTICE This symbol is used to alert the user to useful information about proper operation of the machine.

WARNING

Safety Instructions for Machinery

- 1. READ THROUGH THE ENTIRE MANUAL BEFORE STARTING MACHINERY.** Machinery presents serious injury hazards to untrained users.
- 2. ALWAYS USE ANSI APPROVED SAFETY GLASSES WHEN OPERATING MACHINERY.** Everyday eyeglasses only have impact resistant lenses, they are NOT safety glasses.
- 3. ALWAYS USE HEARING PROTECTION WHEN OPERATING MACHINERY.** Machinery noise can cause permanent hearing damage.
- 4. WEAR PROPER APPAREL. DO NOT** wear loose clothing, gloves, neckties, rings, or jewelry which may get caught in moving parts. Wear protective hair covering to contain long hair and wear non-slip footwear.
- 5. NEVER OPERATE MACHINERY WHEN TIRED, OR UNDER THE INFLUENCE OF DRUGS OR ALCOHOL.** Be mentally alert at all times when running machinery.
- 6. ONLY ALLOW TRAINED AND PROPERLY SUPERVISED PERSONNEL TO OPERATE MACHINERY.** Make sure operation instructions are safe and clearly understood.

WARNING

Safety Instructions for Machinery

7. **KEEP CHILDREN AND VISITORS AWAY.** Keep all children and visitors a safe distance from the work area.
8. **MAKE WORKSHOP CHILD PROOF.** Use padlocks, master switches, and remove start switch keys.
9. **NEVER LEAVE WHEN MACHINE IS RUNNING.** Turn power *OFF* and allow all moving parts to come to a complete stop before leaving machine unattended.
10. **DO NOT USE IN DANGEROUS ENVIRONMENTS.** DO NOT use machinery in damp, wet locations, or where any flammable or noxious fumes may exist.
11. **KEEP WORK AREA CLEAN AND WELL LIT.** Clutter and dark shadows may cause accidents.
12. **USE A GROUNDED EXTENSION CORD RATED FOR THE MACHINE AMPERAGE.** Undersized cords overheat and lose power. Replace extension cords if they become damaged. DO NOT use extension cords for 220V machinery.
13. **ALWAYS DISCONNECT FROM POWER SOURCE BEFORE SERVICING MACHINERY.** Make sure switch is in OFF position before reconnecting.
14. **MAINTAIN MACHINERY WITH CARE.** Keep blades sharp and clean for best and safest performance. Follow instructions for lubricating and changing accessories.
15. **MAKE SURE GUARDS ARE IN PLACE AND WORK CORRECTLY BEFORE USING MACHINERY.**
16. **REMOVE ADJUSTING KEYS AND WRENCHES.** Make a habit of checking for keys and adjusting wrenches before turning machinery *ON*.
17. **CHECK FOR DAMAGED PARTS BEFORE USING MACHINERY.** Check for binding and alignment of parts, broken parts, part mounting, loose bolts, and any other conditions that may affect machine operation. Repair or replace damaged parts.
18. **USE RECOMMENDED ACCESSORIES.** Refer to the instruction manual for recommended accessories. The use of improper accessories may cause risk of injury.
19. **DO NOT FORCE MACHINERY.** Work at the speed for which the machine or accessory was designed.
20. **SECURE WORKPIECE.** Use clamps or a vise to hold the workpiece when practical. A secured workpiece protects your hands and frees both hands to operate the machine.
21. **DO NOT OVERREACH.** Keep proper footing and balance at all times.
22. **MANY MACHINES WILL EJECT THE WORKPIECE TOWARD THE OPERATOR.** Know and avoid conditions that cause the workpiece to "kickback."
23. **ALWAYS LOCK MOBILE BASES BEFORE OPERATING MACHINERY.**

WARNING

Additional Safety Instructions for Meat Saws

- 1. BLADE INSPECTION.** Inspect blades before each use. DO NOT operate with dull or badly worn blade. Dull blades require more effort and are difficult to control.
- 2. HAND PLACEMENT.** Never position fingers or thumbs in line with the cut. Serious personal injury could occur.
- 3. GUARDS.** DO NOT operate this saw without blade guards in place.
- 4. SANITIZATION/CLEANING.** Always sanitize and clean the saw thoroughly before and after cutting meat.
- 5. USDA REGULATIONS.** If you are not familiar with safe meat handling techniques, then contact your local Board of Health or the USDA for proper sanitary practices.
- 6. BLADE REPLACEMENT.** When replacing blades, make sure teeth face down toward the table. The force of the cut is always down towards the table. Make sure the blade is properly tensioned.
- 7. SUPPORTING CUTS.** Cuts should always be fully supported by the table or some type of support fixture.
- 8. STALLED BLADE.** Turn the saw off before attempting to "free" a stalled saw blade.
- 9. BLADE SPEED.** Blade should be running at full speed before beginning a cut.
- 10. FEED RATE.** Always feed material evenly and smoothly. Do not force or twist blade while cutting, especially when sawing through bone.
- 11. BLADE CONTROL.** Allow blade to come to a complete stop before leaving it unattended. DO NOT attempt stop or slow blade.
- 12. MAINTENANCE/ADJUSTMENTS.** All inspections, adjustments, and maintenance are to be done with the power *OFF* and the plug pulled from the outlet. Wait for all moving parts to come to a complete stop.
- 13. HABITS—GOOD AND BAD—ARE HARD TO BREAK.** Develop good habits in your shop and safety will become second-nature to you.
- 14. IF AT ANY TIME IF YOU ARE EXPERIENCING DIFFICULTIES PERFORMING THE INTENDED OPERATION, STOP USING THE MEAT SAW!** Contact our service department or ask a qualified expert how the operation should be performed.

WARNING

Like all machines there is danger associated with the Model H6246. Accidents are frequently caused by lack of familiarity or failure to pay attention. Use this machine with respect and caution to lessen the possibility of operator injury. If normal safety precautions are overlooked or ignored, serious personal injury may occur.

CAUTION

No list of safety guidelines can be complete. Every shop environment is different. Always consider safety first, as it applies to your individual working conditions. Use this and other machinery with caution and respect. Failure to do so could result in serious personal injury, damage to equipment, or poor work results.

SECTION 2: CIRCUIT REQUIREMENTS

110V Operation

!WARNING

Serious personal injury could occur if you connect the machine to the power source before you have completed the set up process. **DO NOT** connect the machine to the power source until instructed to do so.

Amperage Draw

The $\frac{3}{4}$ HP motor on the Model H6246 will draw the following amps:

Motor Load 5 Amps

Circuit Breaker Requirements

Install your machine on a dedicated circuit to reduce the possibility of tripping the circuit breaker. If the circuit breaker frequently trips, have the circuit inspected by a qualified electrician. Never use a larger circuit breaker than stated below, or you will increase the risk of fire.

Circuit Breaker..... 10 Amp

Plug Type

The Model H6246 is supplied with a 5-15 plug, similar to **Figure 2**.

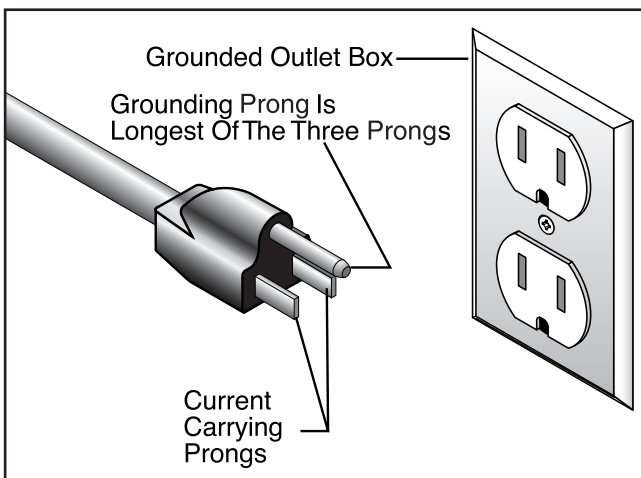

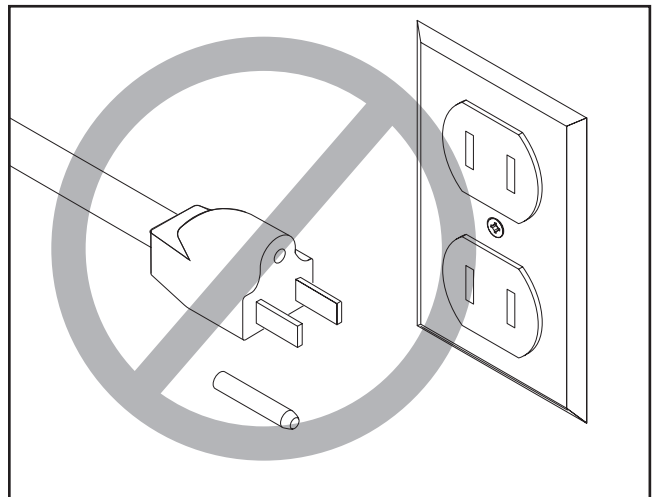

Figure 2. A 5-15 plug and receptacle.



!WARNING

Electrocution or fire could result if this machine is not grounded correctly or if your electrical configuration does not comply with local and state codes. Ensure compliance by checking with a qualified electrician!



!CAUTION

This machine must have a ground prong in the plug to help ensure that it is grounded. **DO NOT** remove ground prong from plug to fit into a two-pronged outlet! If the plug will not fit the outlet, have the proper outlet installed by a qualified electrician.

Extension Cords

- Make sure the cord is rated Standard Service (grade S) or better.
- The extension cord must contain a ground wire and plug pin.
- Use at least a 16 gauge cord. Use a 14 gauge cord if the cord is between 51-100 feet.



SECTION 3: SET UP

Set Up Safety

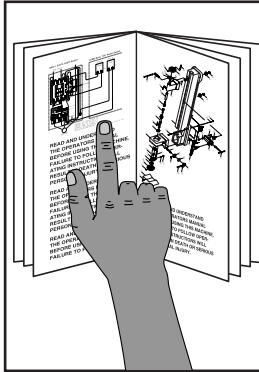

!WARNING

This machine presents serious injury hazards to untrained users. Read through this entire manual to become familiar with the controls and operations before starting the machine!

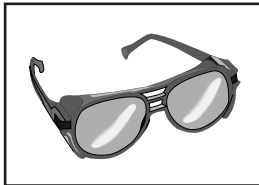

!WARNING

Wear safety glasses during the entire set up process!

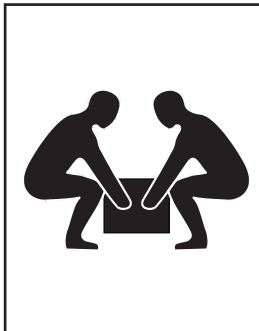

!WARNING

The Model H6246 is a heavy machine 167 lbs. shipping weight). DO NOT over-exert yourself while unpacking or moving your machine—get assistance.



Items Needed for Set Up

The following items are needed to complete the set up process but are not included with your machine:

DESCRIPTION	Qty
Wrenches/Sockets 13mm.....	2
Wrenches/Sockets 10mm	2
Hex Wrench 5mm.....	1
Hex Wrench 4mm.....	1
Hex Wrench 3mm.....	1
Phillips Screwdriver	1
Block.....	1



Unpacking

The Model H6246 was carefully packed when it left our warehouse. If you discover the machine is damaged after you have signed for delivery, please immediately call Customer Service at (570) 546-9663 for advice.

Save the containers and all packing materials for possible inspection by the carrier or its agent. Otherwise, filing a freight claim can be difficult.

When you are completely satisfied with the condition of your shipment, you should inventory the contents.



Inventory

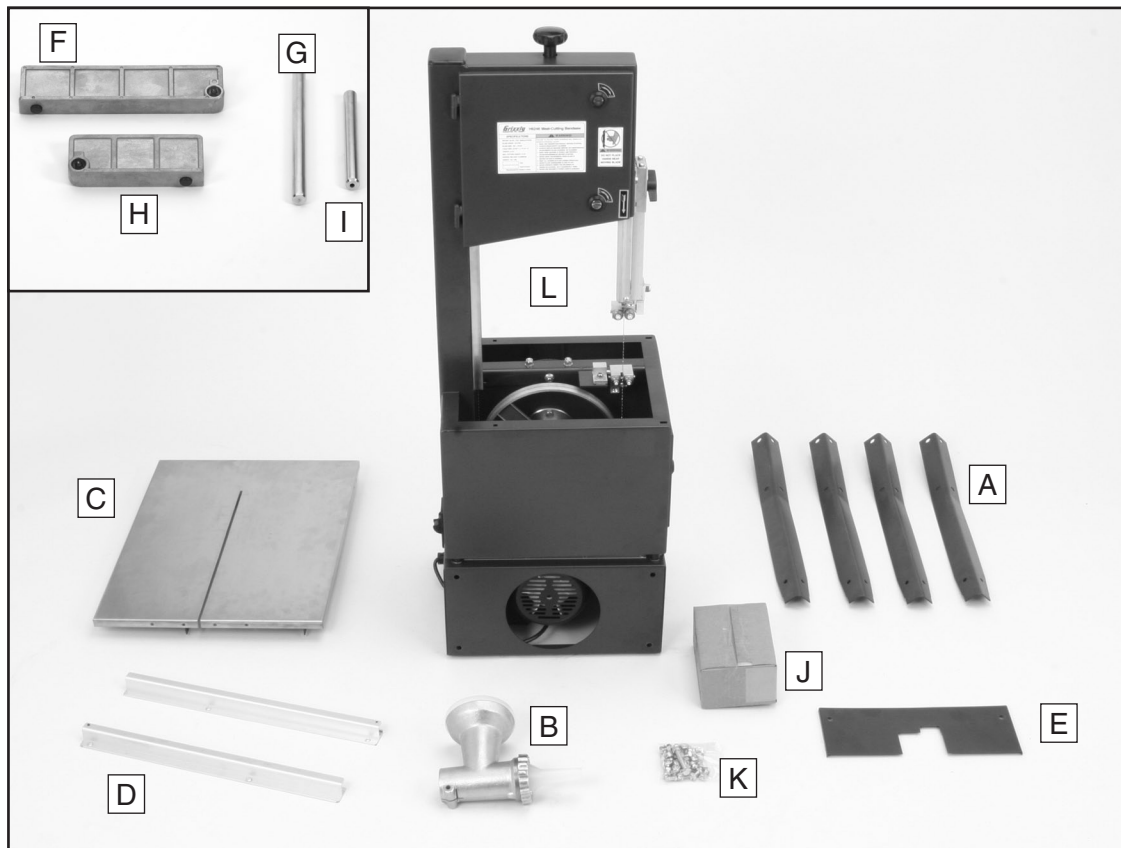

Figure 3. Inventory.

After all the parts have been removed from the two boxes, you should have the following items:

Inventory: (Figure 3)

	Qty
A. Legs.....	4
B. Meat Grinder Assembly.....	1
C. Sliding Table.....	1
D. Rails (front/rear)	2
E. Cover Plate.....	1
F. Long Fence	1
G. Long Rail	1
H. Short Fence.....	1
I. Short Rail.....	1
J. Box	1
—Rail Brackets.....	2
—Table Brace	1
—Rubber Feet.....	4

K. Bolt Bag.....	1
—Hex Bolts M8-1.25 x 16	8
—Hex Bolt M8-1.25 x 60.....	1
—Hex Bolts M6-1 x 16	4
—Hex Bolts M6-1 x 8	4
—Hex Nuts M8-1.25.....	9
—Hex Nuts M6-1.....	4
—Carriage Bolts M6-1 x 12.....	4
—Cap Screws M6-1 x 20	2
—Knob Bolts M8-1.25 x 20	2
—Set Screws M8-1.25 x 12	2
—Flat Washers 6mm	4
—Acorn Nuts M6-1	4
L. Main Body	1







In the event that any nonproprietary parts are missing (e.g. a nut or a washer), we would be glad to replace them, or for the sake of expediency, replacements can be obtained at your local hardware store.



Hardware Recognition Chart







USE THIS CHART TO MATCH UP
HARDWARE DURING THE ASSEMBLY
PROCESS!

MEASURE BOLT DIAMETER BY PLACING INSIDE CIRCLE

-  #10
-  1/4"
-  5/16"
-  3/8"
-  7/16"
-  1/2"



Key

-  4mm
-  6mm
-  8mm
-  10mm
-  12mm
-  16mm

LINES ARE 1MM APART

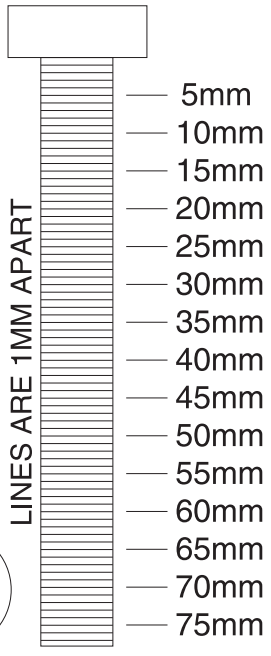

LINES ARE 1/16" INCH APART

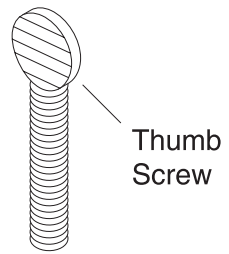
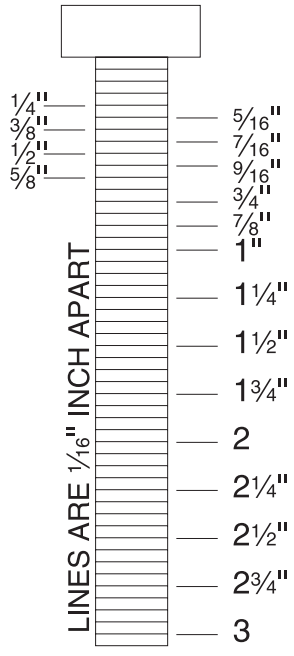

Thumb Screw

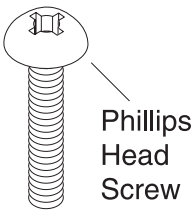

Phillips Head Screw

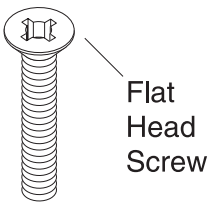

Flat Head Screw

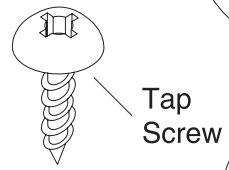

Tap Screw

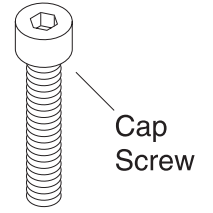

Cap Screw

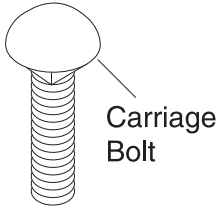

Carriage Bolt

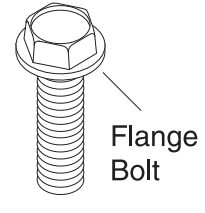

Flange Bolt

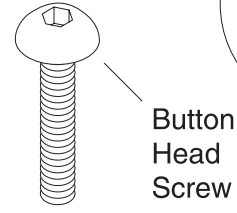

Button Head Screw

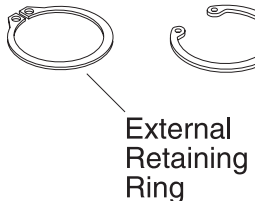

External Retaining Ring

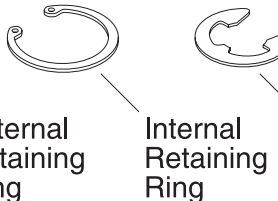

Internal Retaining Ring

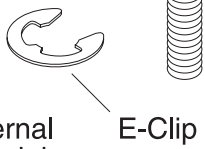

E-Clip

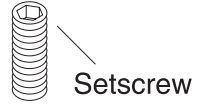

Setscrew

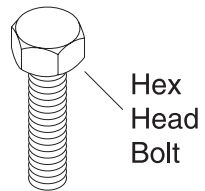

Hex Head Bolt



Lock Nut

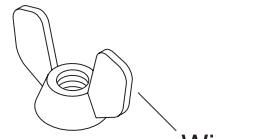

Wing Nut

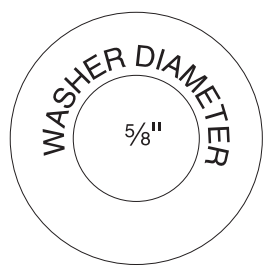

WASHER DIAMETER
5/8"

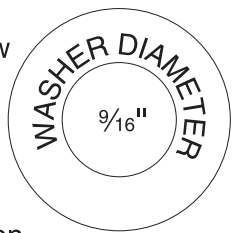

WASHER DIAMETER
9/16"

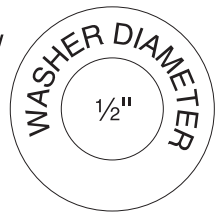

WASHER DIAMETER
1/2"

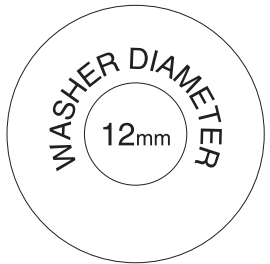

WASHER DIAMETER
12mm



WASHER DIAMETER
7/16"



WASHER DIAMETER
3/8"

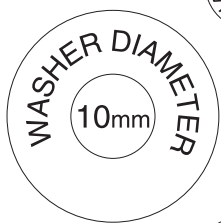

WASHER DIAMETER
10mm



WASHER DIAMETER
4mm



WASHER DIAMETER
5/16"



WASHER DIAMETER
6mm



WASHER DIAMETER
1/4"

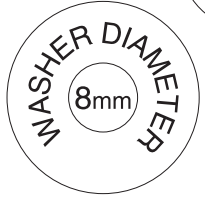

WASHER DIAMETER
8mm



WASHER DIAMETER
#10

WASHERS ARE MEASURED BY THE INSIDE DIAMETER

Clean Up

The table and guard pieces come with a protective coating. Peel this off before cleaning these pieces. Clean and sanitize all parts of the saw that will be in contact with meat or any other food items. The smaller items and table will fit in most dishwashers. This is probably the easiest method of cleaning and sanitizing these parts. For the larger parts of the saw, if a dishwasher is not a viable option, clean with a sanitizing agent. See *Section 5: Sanitization* on **page 23** for more details on sanitizing. Get in the habit of cleaning your saw thoroughly to avoid contamination and illness.

WARNING

When cleaning with sanitizers, always follow the recommendations on the manufacturer's label, and make sure that the product will do the job for which you intend. Never use a product that will make your meat unsafe for human consumption. Failure to follow this warning may lead to sickness or death!



Site Considerations

Floor Load

The Model H6246 weighs 154 lbs. and has a base footprint of 19" W x 16" D. Most floors are suitable for your machine. Some residential floors may require additional reinforcement to support both the machine and operator. Never operate the machine without solid footing.

Working Clearances

Consider existing and anticipated needs, size of material to be processed through each machine, and space for auxiliary stands, work tables or other machinery when establishing a location for your saw. See **Figure 4** for the minimum working clearances of the Model H6246.

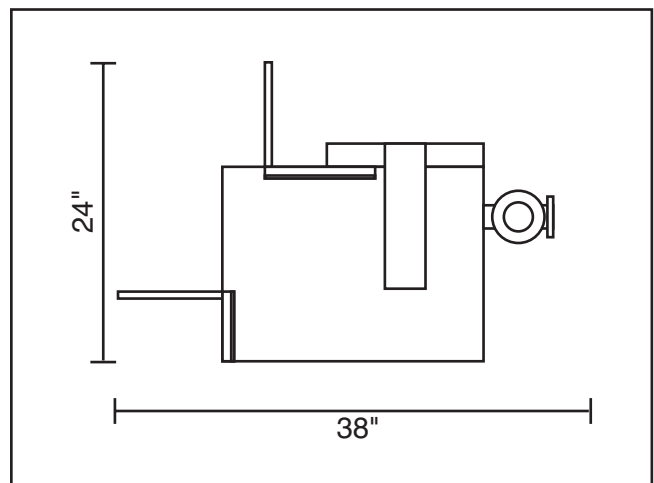
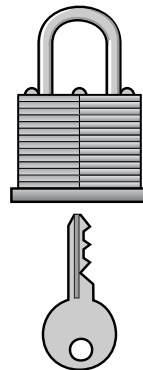

Figure 4. Working clearances.



CAUTION

Unsupervised children and visitors inside your shop could cause serious personal injury to themselves. Lock all entrances to the shop when you are away and **DO NOT** allow unsupervised children or visitors in your shop at any time!



Legs

Components and Hardware Needed:		Qty
Hex Bolts M8-1.25 x 16		8
Hex Nuts M8-1.25.....		8
Legs.....		4
Rubber Feet.....		4

Tools Needed:		Qty
Wrenches/Socket 13mm.....		2
Block.....		1

To install the legs:

1. With the help of an assistant, lay the bandsaw down on a block to support the base as shown in **Figure 5**, and insert the legs into the base.

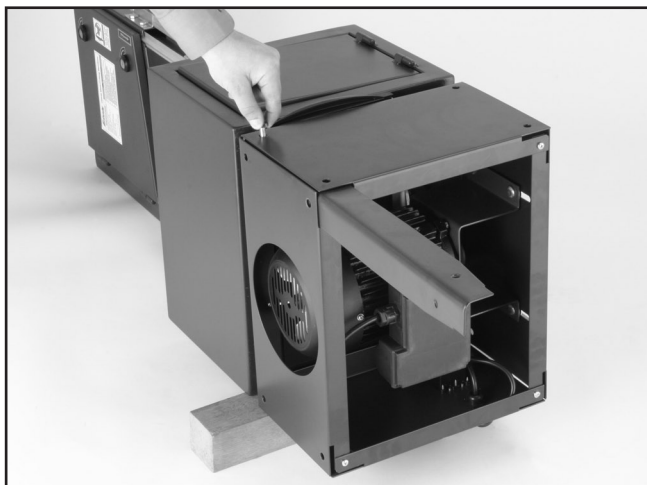

Figure 5. Installing legs to the base.

2. Insert the hex bolts through the body and legs (**Figure 5**), and fasten with the hex nuts.
3. Place the rubber feet on the bottom of the legs.
4. With the help of an assistant, lift the bandsaw upright.



Tensioning Blade

The bandsaw blade must be adequately tensioned so that it will cut straight and not fall off the wheel during operation.

To tension the blade:

1. **Unplug the bandsaw:**
2. Turn the tension knob (**Figure 6**) clockwise to increase blade tension and counterclockwise to decrease blade tension.



Figure 6. Tension knob.

3. Adjust the blade tension until the blade deflects approximately $\frac{1}{4}$ " with moderate pressure from your finger.



Blade Tracking

To track the blade:

1. **Unplug the bandsaw!**
2. Adjust the upper and lower guide bearings and support bearings as far away as possible from the blade.
3. Open the upper wheel cover.
4. Spin the upper wheel by hand at least three times and watch how the blade rides on the crown of the wheel. Refer to **Figure 7** for an illustration of this concept.

—If the blade rides in the center of the upper wheel and is centered on the peak of the wheel crown, then the bandsaw is already tracked properly and no further adjustments are needed at this time.

—If the blade does not ride in the center of the upper wheel and is not centered on the peak of the wheel crown, then continue with the following steps.

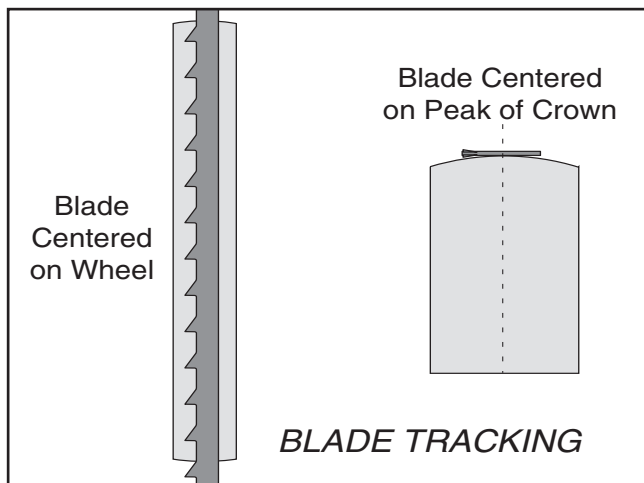

Figure 7. Blade tracking profiles.

5. Loosen the lock knob on the tracking control knob threads, so that the tracking control knob will rotate for adjustments.
6. Spin the upper wheel with one hand and rotate the tracking control knob (**Figure 8**) with the other hand:

—If the blade rests too far back on the wheel, turn the tracking control knob counterclockwise until the blade is tracking correctly.

—If the blade rests too far forward on the wheel, turn the tracking control knob clockwise until the blade is tracking correctly.



Figure 8. Tracking control knob.

7. Tighten the tracking control lock knob and close the upper wheel cover.

For the best performance from your saw, regularly maintain the proper tracking of the blade.

NOTICE

Changes in the blade tension may change the blade tracking.



Adjusting Support Bearings

Tools Needed:	Qty
Hex Wrench 3mm.....	1
Hex Wrench 5mm.....	1

To adjust the support bearings:

- 1. Unplug the bandsaw!**
- Look at the support bearings and determine if the support bearings are centered behind the blade.
 - If the support bearing is centered behind the blade continue to **step 4**.
 - If the support bearing is not centered continue to **step 3**.
- Loosen the two set screws shown in **Figure 9** with the 3mm hex wrench, and adjust the blade guide assembly until the support bearing is centered behind the blade, then tighten the set screws.

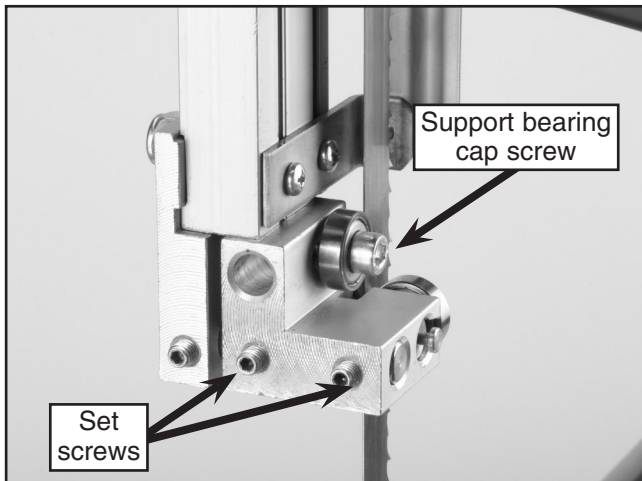

Figure 9. Blade guide assembly (rear view).

- Loosen the support bearing cap screw with the 5mm hex wrench and adjust the bearing until it rest 0.16"—about the thickness of a dollar bill folded twice—between the blade and support bearing; tighten the cap screw.



Adjusting Blade Guides

The blade guide bearings provide side-to-side support to help keep the blade straight while cutting.

Tools Needed:	Qty
Hex Wrench 5mm.....	1

To adjust the blade guides:

- 1. Unplug the bandsaw!**
- Familiarize yourself with the blade guide controls shown in **Figure 10**.

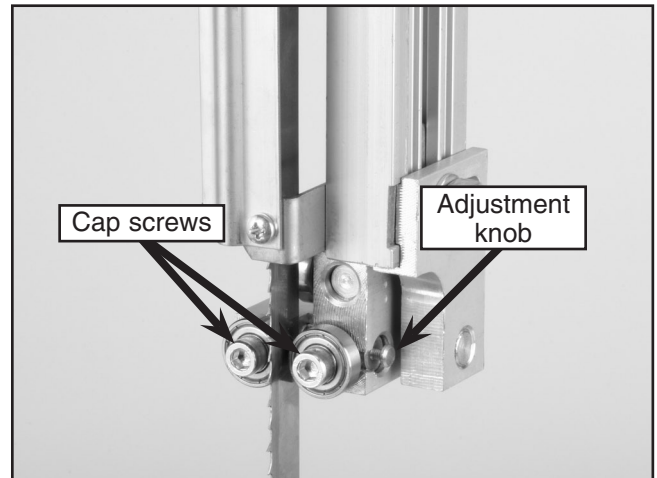

Figure 10. Blade guide controls.

- Loosen the cap screws and adjust the guide bearings with the adjustment knobs to within .004" of the blade. Note—.004" is approximately the thickness of a piece of paper.
- Tighten the cap screws.



Table

Components and Hardware Needed:	Qty
Sliding Table.....	1
Table Brace	1
Cover Plate.....	1
Cap Screws M6-1 x 20.....	2
Hex Nuts M6-1	4
Hex Bolts M6-1 x 8.....	4
Flat Washers 6mm	4
Front Rail (w/Groove for Bearing)	1
Rear Rail	1
Carriage Bolts M6-1 x 12.....	4
Acorn Nuts M6-1	4

Tools Needed:	Qty
Wrench or Socket 10mm.....	2

To install the table:

1. Place the cover plate on the saw unit as shown in **Figure 11**.

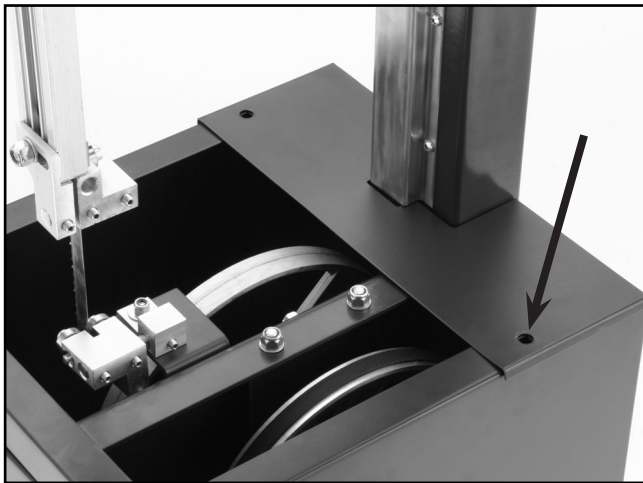

Figure 11. Cover plate in the correct position with holes aligned.

2. Place the rear rail over the cover plate and align the mounting holes.
3. Secure the rear rail and cover plate to the saw body with two carriage bolts and acorn nuts. Note—*The acorn nuts are meant to be mounted outside of the saw body, as shown in **Figure 12**.*

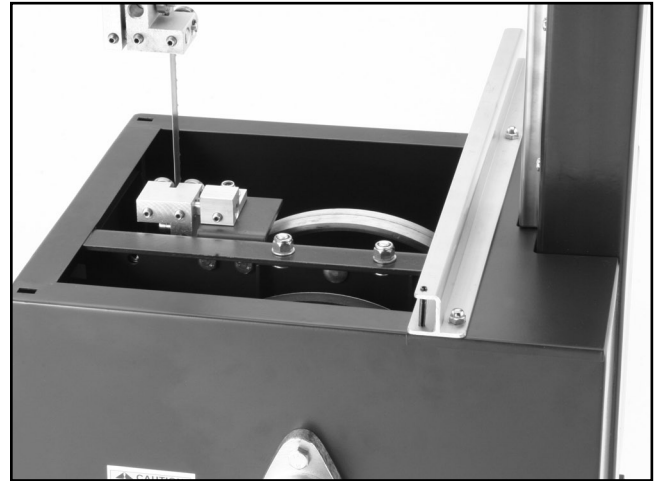

Figure 12. Rear rail attached to saw body.

4. Install the front rail in the same manner as the rear rail.
5. Slide the table onto the rails so the table rollers roll freely along the rails.
6. Standing at the back of the saw, push the table forward as far as it will go.
7. Install the table brace on the back of the table, up underneath the table lip, and secure it with the four hex bolts and flat washers (**Figure 13**).



Figure 13. Attaching table brace.

8. Thread one M6-1 hex nut halfway onto each of the two cap screws, as shown in **Figure 14**.



Figure 14. Hex nut threaded halfway onto cap screw.

9. Insert the two cap screws into the table runners so the heads are facing outward, and tighten the remaining two hex nuts onto the ends, as shown in **Figure 15**. *Note—These cap screws act as the table stops when the table is slid backwards.*



Figure 15. Cap screws installed in table runners.



Fences

Components and Hardware Needed:	Qty
Long Fence	1
Short Rail.....	1
Short Fence.....	1
Long Rail	1
Knob Bolts M8-1.25 x 20	2
Set Screws M8-1.25 x 12.....	2
Hex Bolts M6-1 x 16	4
Rail Brackets	2

Tools Needed:	Qty
Wrench or Socket 10mm.....	1

To assemble fence:

1. Mount the two rail brackets to the edge of the table with the hex bolts, as shown in **Figure 16**.

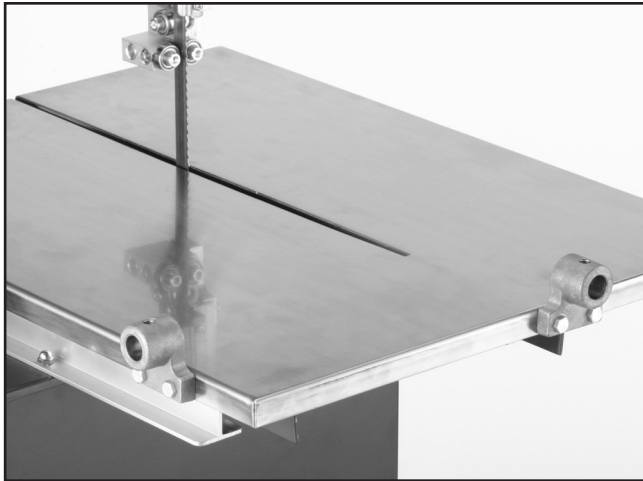

Figure 16. Rail brackets installed on table.

2. Insert the end of the long rail into the short fence and secure together with one of the set screws (**Figure 17**).
3. Insert the end of the short rail into the long fence and secure together with the remaining set screw.



Figure 17. Securing fence to rail.

4. Slide the long rail/short fence assembly into the bracket that is mounted on the front of the table.
5. Slide the short rail/long fence assembly into the bracket that is mounted on the left-side of the table.
6. Use the knob bolts to tighten both fence rails to the fence brackets. Your completed assembly should look like **Figure 18**.

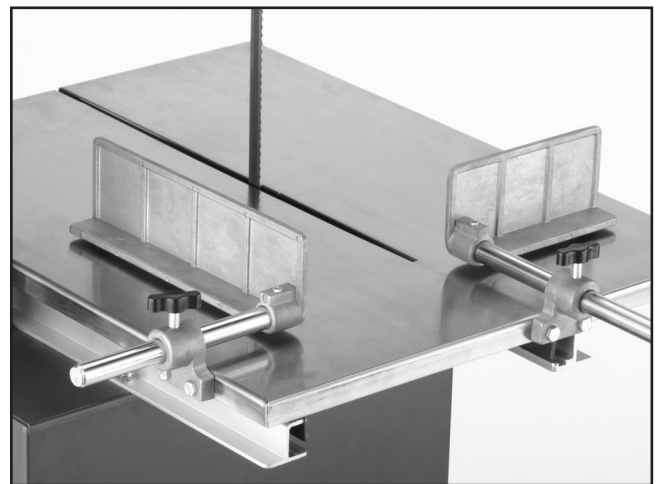

Figure 18. Completed assembly of fences and rails.



Meat Grinder

Components and Hardware Needed:	Qty
Meat Grinder Assembly	1
Hex Bolt M8-1.25 x 60	1
Hex Nut M8-1.25	1

Tools Needed:	Qty
Wrench or Socket 13mm	2

To install the meat grinder:

1. Make sure the fork inside the meat grinder lines up with the tang inside of the housing that is mounted on the saw body, and slide the meat grinder all the way onto the housing (**Figure 19**).

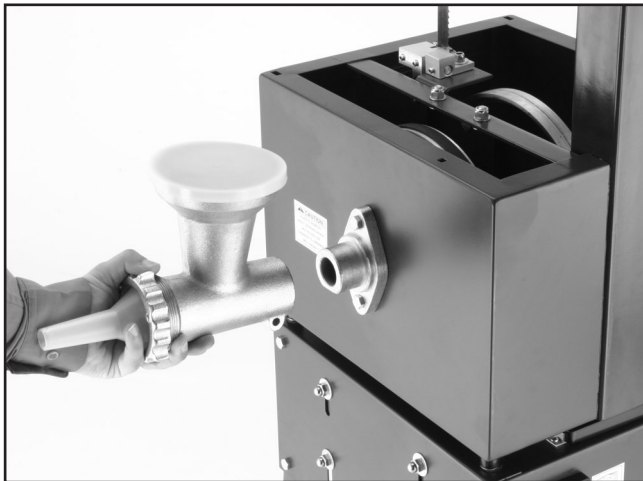

Figure 19. Meat grinder installation.

2. Insert the hex bolt through the bolt hole on the meat grinder assembly and fasten securely with the hex nut.

CAUTION

Allways remove the meat grinder when it is not being used. Failure to do so may result in damage to the meat grinder, because there is no lubrication source without meat being processed.



Test Run

Once assembly is complete and adjustments are done to your satisfaction, you are ready to start the machine.

Turn the machine *ON*. Make sure that your finger is poised on the OFF button just in case there is a problem. The bandsaw should run smoothly with little or no vibration or rubbing noises. Strange or unnatural noises should be investigated and corrected before operating the machine further.

Run the Model H6246 for a short time to ensure that the moving parts are working properly with no excessive vibration. If any problems develop, correct them before any further use the machine.

If you cannot locate the source of unusual noises, please contact our service department at (570) 546-9663.



SECTION 4: OPERATIONS

Operation Safety

	<p>⚠️ WARNING Damage to your eyes could result from using this machine without proper protective gear. Always wear safety glasses when operating this machine.</p>
---	---

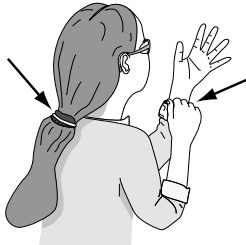
	<p>⚠️ WARNING Loose hair and clothing could get caught in machinery and cause serious personal injury. Keep loose clothing and long hair away from moving machinery.</p>
--	---

<p style="text-align: center;">NOTICE</p> <p>If you have never used this type of machine or equipment before, WE STRONGLY RECOMMEND that you read books, trade magazines, or get formal training before beginning any projects. Regardless of the content in this section, Grizzly Industrial will not be held liable for accidents caused by lack of training.</p>



Key Switch

One of the most useful safety features of the Model H6246 is the removable key (**Figure 20**). To lock-out the ON/OFF switch remove the key. If at any time during operation of the bandsaw a safety hazard presents itself, immediately turn the machine **OFF**.



Figure 20. H6246 ON/OFF switch.

	<p>⚠️ CAUTION Unsupervised children and visitors inside your shop could cause serious personal injury to themselves. Lock all entrances to the shop when you are away and DO NOT allow unsupervised children or visitors in your shop at any time!</p>
--	--



Guide Post

The guide post (**Figure 21**) connects the upper blade guide assembly to the bandsaw. The function of the guidepost is to allow the blade guide assembly to move up or down depending on the height of the meat being cut. The blade guide assembly must be no more than 1" from the top of the meat at all times—this positioning provides the greatest support to the blade.

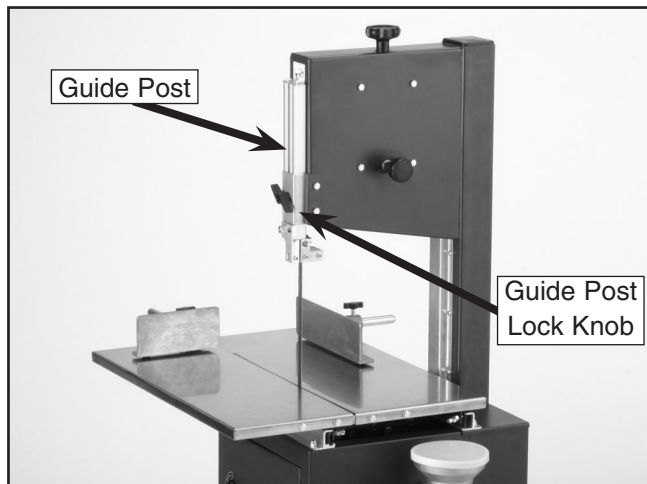

Figure 21. Guide post controls.

To adjust guide post assembly alignment on the guide post:

1. **Unplug the bandsaw!**
2. Make sure that the blade tension, blade tracking, support bearing, and blade guides are adjusted correctly.
3. Loosen the guide post lock knob shown in **Figure 21**.
4. Raise/lower the guide post to within 1" from the top of the meat to the bottom of the blade guide assembly.
5. Lock the guide post in place with the lock knob.



Changing Blades

Components and Hardware Needed:	Qty
New Saw Blade	1

Tools Needed:	Qty
Hex Wrench 4mm.....	1
Phillips Screwdriver	1
Leather Gloves (pair).....	1

To change blades:

1. **Unplug the bandsaw!**
2. Remove the table, left rail, and cover plate, then adjust the blade guides as far away from the blade as possible.
3. Detension the blade with the tension control knob, and open the wheel covers.
4. Remove the blade guards with the Phillips head screwdriver.
5. Put on the leather gloves and carefully remove the blade from the bandsaw.
6. Installation is the opposite of removal. Once the blade is installed, remember to tension it properly, reinstall the blade guard, and set the blade guides.



Cutting Meat

Your Model H6246 Meat-Cutting Bandsaw will cut through any fresh meat and almost all frozen meat.

To cut meat with your bandsaw:

1. Use the side fence to gauge the thickness of your desired cut. The front fence should brace the meat. Make sure the fences will not be in line with the cut.
2. Turn the bandsaw *ON* and slowly guide the meat into the blade by sliding the table. With frozen meat, pay close attention to the feed-rate. All cuts should be slow and smooth. If you hear the motor slow down or struggle with the cut, stop cutting.
3. Clear the slice you just cut and slide the meat toward the side fence. You can make successive cuts and the following slices will be the same thickness as the first.

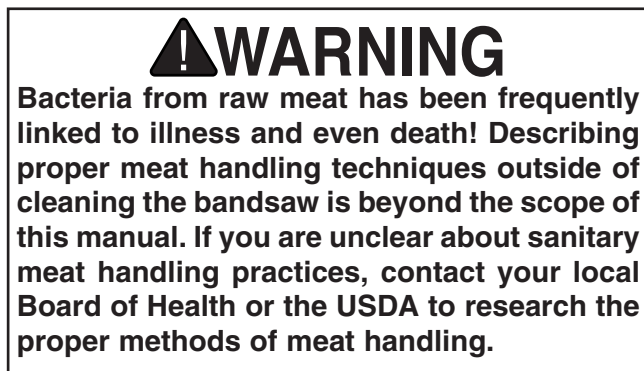
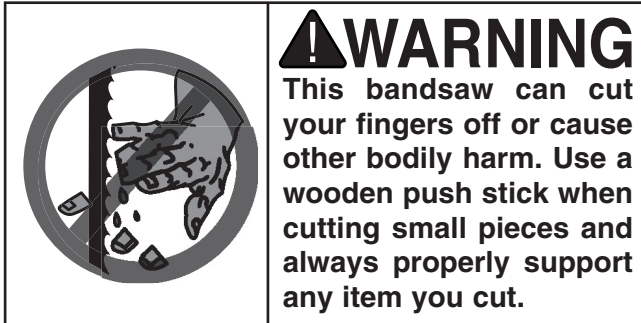

Grinding Meat

The meat grinder is great for grinding hamburger and sausage. The grinder automatically engages when it is mounted to the bandsaw unit.

To use the meat grinder:

1. Make sure that all the grinder components are cleaned and sanitized thoroughly. Refer to *Section 5: Sanitization* on **page 23**.
2. Install the meat grinder as explained on **page 19**.
3. Lower the blade guide as low as it will go and lock it in place.
4. Prepare a place for the ground meat to exit the grinder.
5. Drop 1 $\frac{1}{2}$ " cubes of meat into the grinder, one at a time. Always use the pusher to push the meat into the spinning auger; never use your fingers.
6. Always thoroughly clean and sanitize all parts of the grinder that have been exposed to meat or food particles. Refer to *Section 5: Sanitization* on **page 23**.

Note—*DO NOT* leave the meat grinder installed on the bandsaw when not in use.

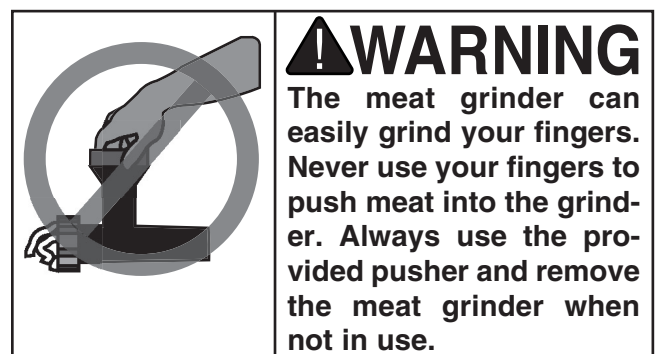

SECTION 5: SANITIZATION



!WARNING
Always be as thorough as possible when cleaning and sanitizing your meat cutting bandsaw components. Any parts that have been exposed to raw meat or bone may harbor or develop bacteria that may cause illness or death if left uncleaned.



!WARNING
Cleaning the bandsaw while it is plugged in may cause severe electrical shock! Always disconnect the power before attempting any cleaning or maintenance operations, and after cleaning. Never connect the bandsaw to a power source until it is dry. Failure to follow this warning may result in severe injury or even death.



!WARNING
When cleaning with sanitizers, always follow the recommendations on the manufacturer's label, and make sure that the product will do the job for which you intend. Never use a product that will cause exposed surfaces to render meat unsafe for human consumption. Failure to follow this warning may lead to sickness or death!

Cleaning the Saw

To clean your bandsaw after use:

1. Remove the table, the blade guards, the fences, the blood tray, and the meat grinder (Figure 22).
2. If it was used, disassemble the meat grinder (Figure 23).

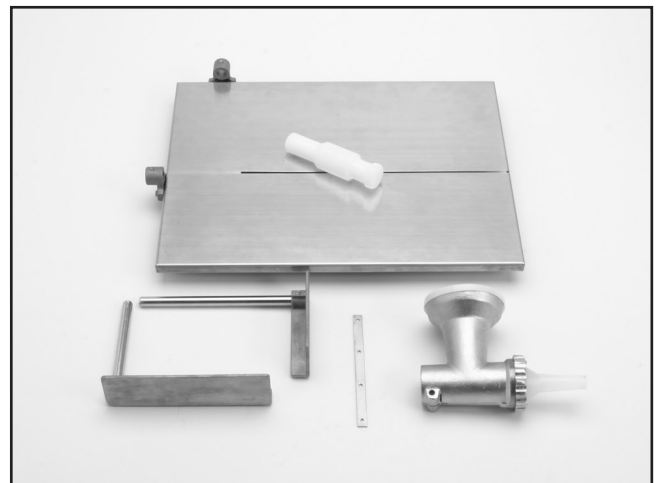

Figure 22. Pieces disassembled for cleaning.



Figure 23. Meat grinder components disassembled for cleaning.

3. Remove the blade from the wheels of the bandsaw (Refer to *Changing Blades* on **page 21**). Sanitize all removed pieces from the meat grinder and bandsaw, according to the *Proper Sanitation* instructions. If you have access to a dishwasher, use it to sanitize the parts that will fit.
4. Clean the wheels and any other part of the bandsaw unit that may have been exposed to raw meat with a direct application sanitizer (read *Proper Sanitation* instructions).



Proper Sanitation

All surfaces and working parts that have been exposed to meat must be properly sanitized after each use.

Dishwashers are a good option because they sanitize with heat. For all pieces that will not fit in the dishwasher, or if a dishwasher is not available, chemical sanitizers like bleach or iodophor solution are good options. When using chemical sanitizers, make sure they are designed to do the job, and strictly follow the manufacturer's recommendations for proper use.

Proper sanitation with chemical sanitizers requires a process before the actual sanitizer is applied.

The following is an effective method to prepare an item for sanitation:

1. Gather all the items that need to be cleaned. Remove the largest particles of foodstuffs into a garbage container. Rinse all items to remove as many of the leftover particles as possible. Set the items aside.
2. Prepare the sink. Wash and scrub all sink compartments with dish soap and hot water. Rinse these compartments thoroughly.

3. Fill a sink with soapy water, submerge the item and scrub the entire surface thoroughly.
4. Using hot water, rinse the newly cleaned item until all visible suds have been removed. Repeat this process for all of the items that need to be sanitized. If the soapy water starts to get hazy, drain and rinse the sink, then fill with more soapy water.

The items are now ready to be sanitized. Some sanitizers require direct applications, while others are designed to be diluted in water and used to soak the item for a specified period of time. The best method for choosing a chemical sanitizer is to do the research and determine which product is best for your particular situation.

One simple sanitizer that can be used for many applications is regular bleach. To use bleach as a sanitizer, wash, scrub, and rinse your sink. For all non-porous surfaces (includes all parts of this bandsaw), fill the sink with one tablespoon of bleach per gallon of cool water. Do not use bleach that contains odor masking agents or surfactants. These have not been proven effective for this type of sanitation. Submerge each item for two minutes. For large items, submerge each side for the specified amount of time until you have covered the entire area. Allow to air dry. Do not rinse these items after sanitation!

If your raw meat comes into contact with non-porous surfaces (wood), clean as described above and soak these surfaces for two minutes in a solution of 3 tablespoons of bleach to one gallon of cool water. Rinse these items well!



SECTION 6: ACCESSORIES

G7984—Face Shield

H1298—Dust Sealed Safety Glasses

H1300—UV Blocking, Clear Safety Glasses

H2347—Uvex® Spitfire Safety Glasses

H0736—Shop Fox® Safety Glasses

Safety Glasses are essential to every shop. If you already have a pair, buy extras for visitors or employees. You can't be too careful when it comes to shop safety!



Figure 24. Our most popular safety glasses.

G8683—Mini Shop Fox® Mobile Base

Don't let the little size of this one fool you. It shares the same design concepts as it's two bigger brothers, giving you an amazing 600 lb. load capacity in one small package!



Figure 25. Model G8683 Mini Shop Fox® Mobile Base.

H1302—Standard Earmuffs

H4979—Deluxe Twin Cup Hearing Protector

H4977—Work-Tunes Radio Headset Earmuffs

Protect yourself comfortably with a pair of cushioned earmuffs. Especially important if you or employees operate for hours at a time.

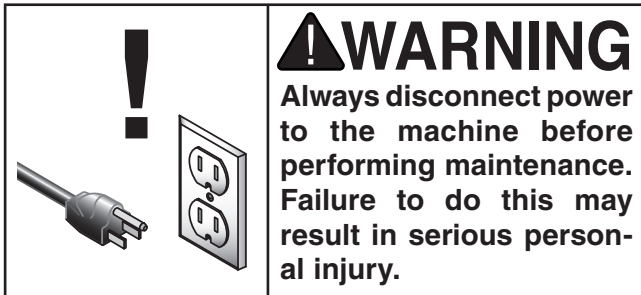

Figure 26. Our most popular earmuffs.

Call 1-800-523-4777 To Order



SECTION 7: MAINTENANCE



Schedule

To keep your bandsaw running well, follow this maintenance schedule and refer to any specific instructions given in this section.

Daily Check:

- Loose mounting bolts.
- Damaged saw blade.
- Worn or damaged wires.
- Any other unsafe condition.

Monthly Check:

- V-belt tension, damage, or wear.
- Clean and sanitizer any buildup from inside cabinet and off motor.



Table & Blade

Maintain your table and blade with a thin film of food grade lubricant that will not support bacteria growth nor become rancid. These qualities are important because some food grade oils will become rancid over time and may cause illnesses. Make sure that the product you use is specifically designed for protecting food processing machinery. Always follow the manufacturer's recommendations when using their products.



V-Belt

Avoid getting grease or oil on the V-belt or pulleys. Check the V-belt, as part of a monthly inspection for proper tension and belt condition. Cracking and glazing could result in belt failure. Replace the belt if such conditions appear.



Lubrication

The wheel bearings are shielded and lubricated for life; thus, they require no maintenance throughout their lifespan. Occasionally lubricate the tracking and height adjustment controls with the same food grade lubricant that you use on the table.

DO NOT lubricate the meat grinder. The meat processed in the grinder serves as a natural lubricant.





H6246 110V Single-Phase

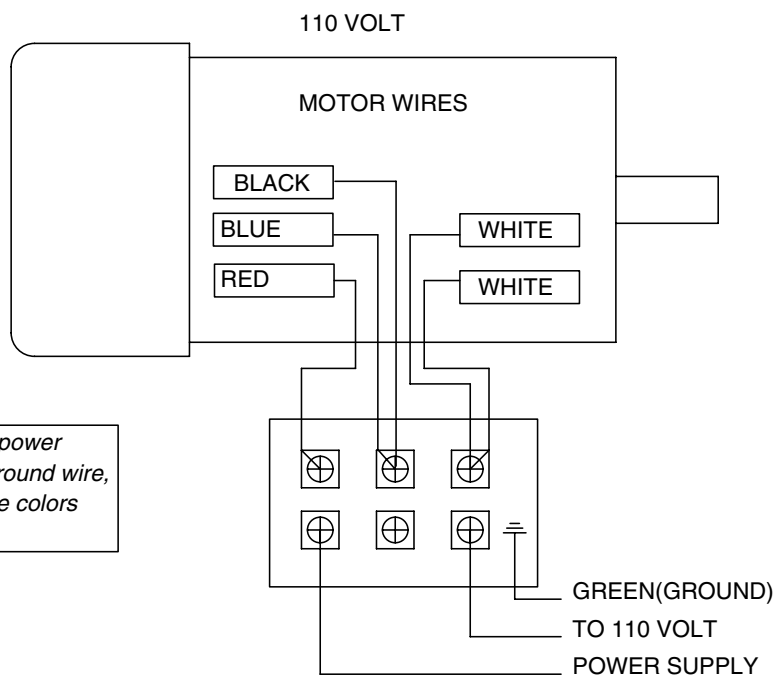

NOTE—The wires from the power supply, besides the green ground wire, are interchangeable, therefore colors are not specified.

DANGER

Disconnect power before performing any electrical service. Electricity presents serious shock hazards that will result in severe personal injury and even death!

H6246 Parts Breakdown

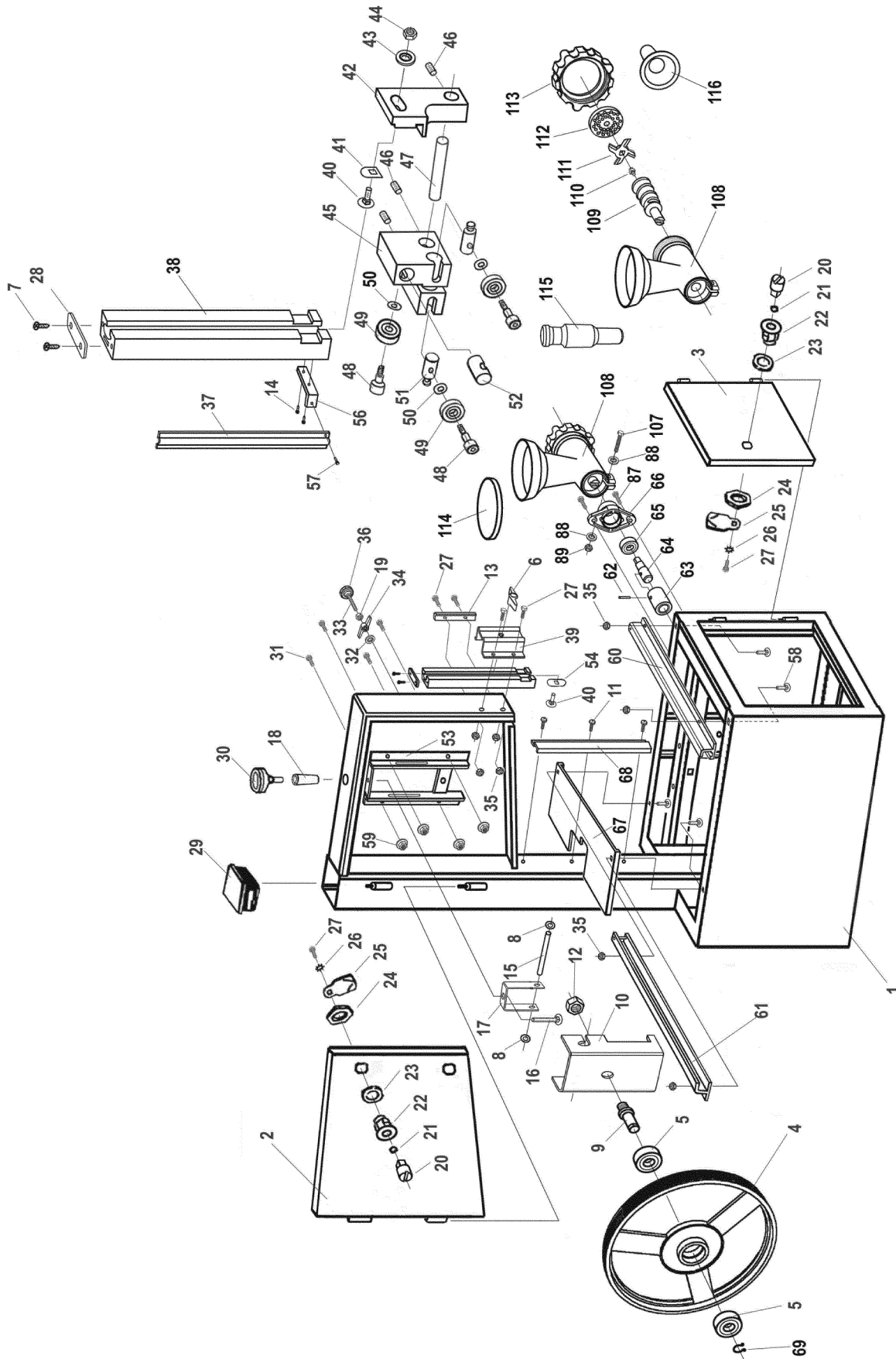

H6246 Parts Breakdown

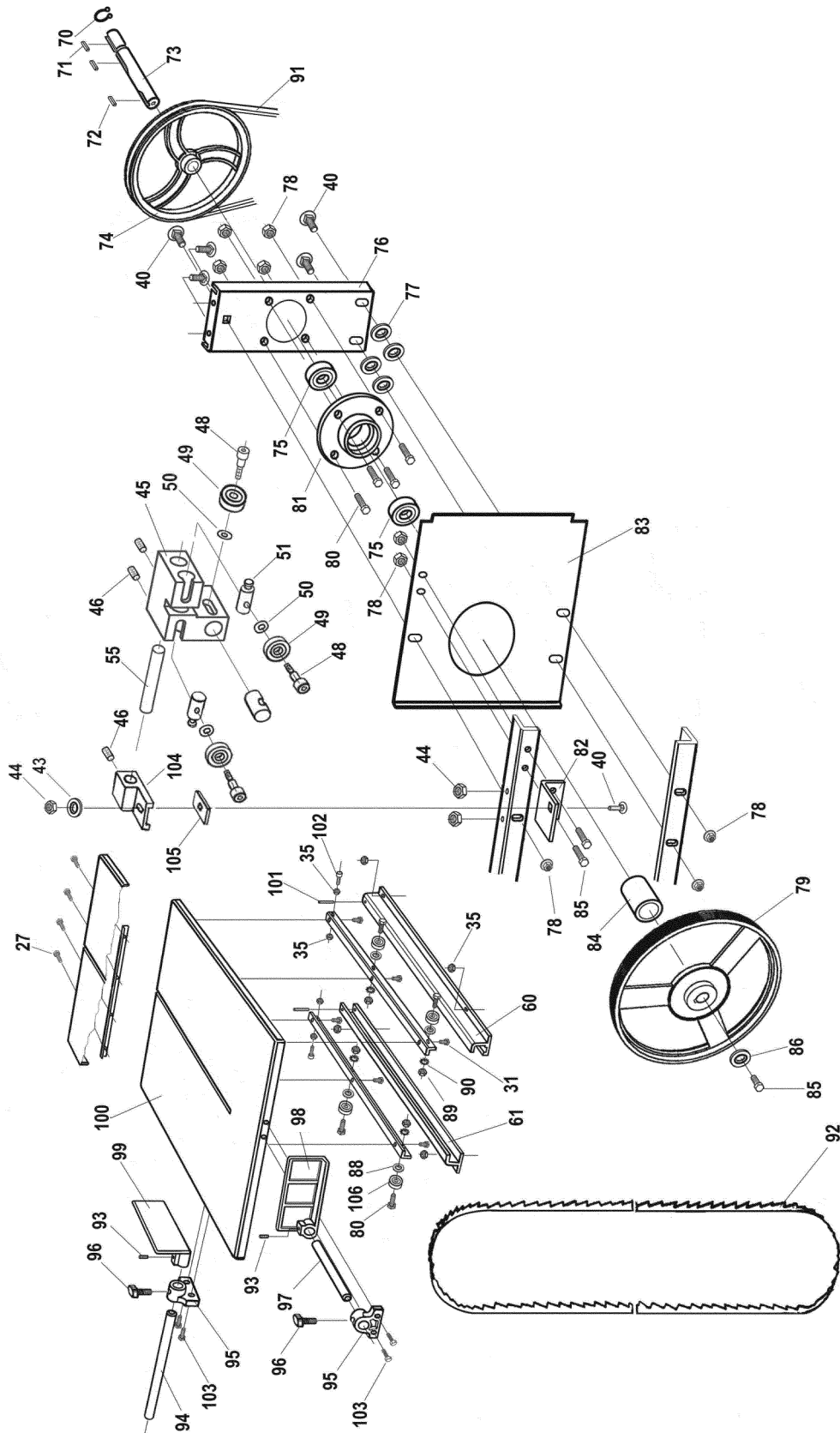

H6246 Parts Breakdown

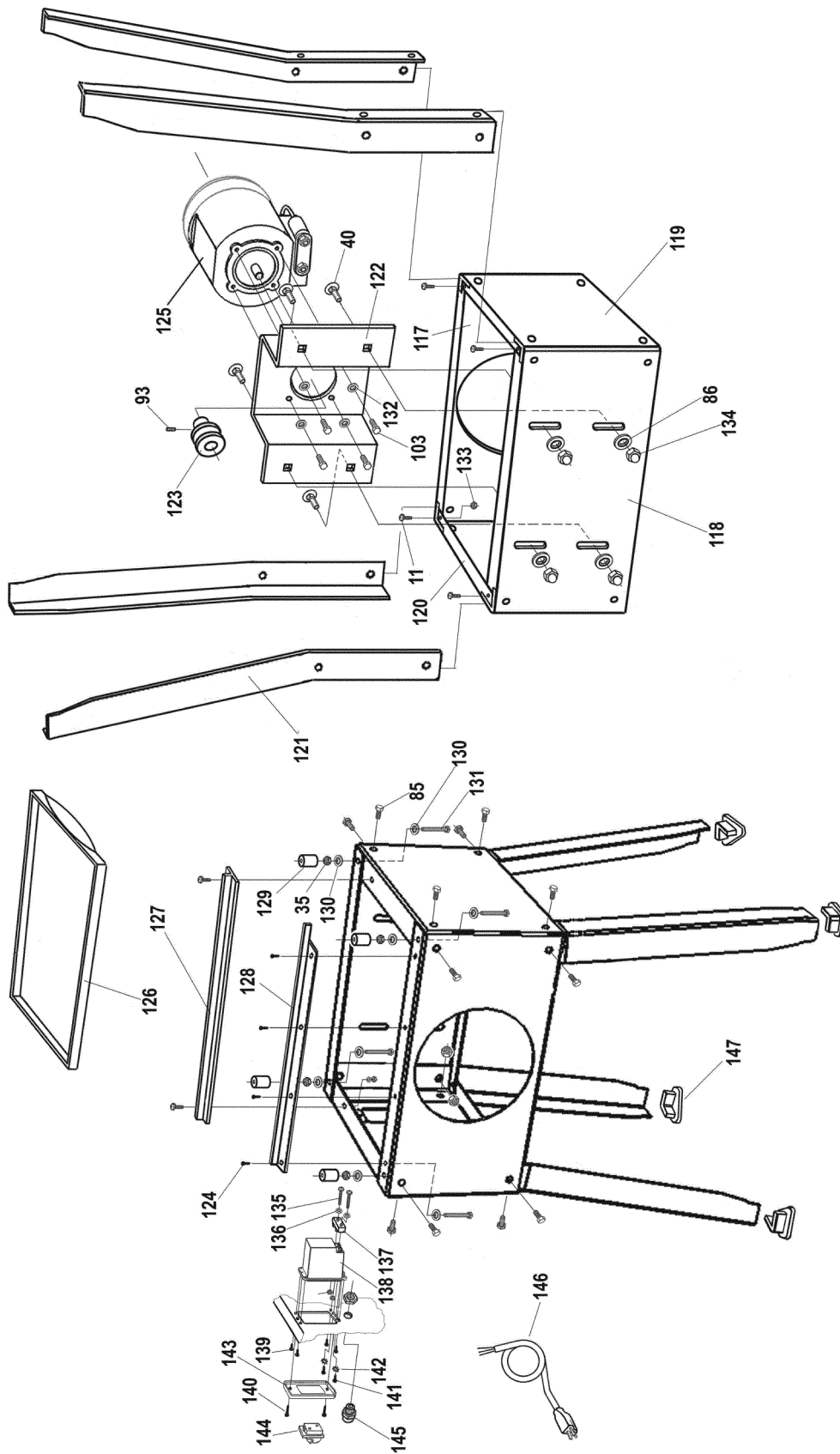

H6246 Parts List

REF	PART #	DESCRIPTION
1	PH6246001	MEAT SAW FRAME
2	PH6246002	UPPER DOOR
3	PH6246003	LOWER DOOR
4	PH6246004	UPPER WHEEL
5	P80202	BALL BEARING 80202
6	PWN02M	WING NUT M8-1.25
7	PHTEK17M	TAP SCREW 5 X 20
8	PR65M	EXT RETAINING RING 3MM
9	PH6246009	UPPER BALL BEARING SHAFT
10	PH6246010	WHEEL CARRIER BRACKET
11	PS09M	PHLP HD SCR M5-.8 X 10
12	PN32M	HEX NUT M14-2
13	PH6246013	TWO HOLE PLATE
14	PS07M	PHLP HD SCR M4-.7 X 8
15	PH6246015	PARALLEL PIN
16	PCB19M	CARRIAGE BOLT M8-1.25 X 50
17	PH6246017	TENSION BRACKET
18	PH6246018	BLADE TENSIONER ROD
19	PN01M	HEX NUT M6-1
20	PH6246020	SLOTTED INSERT
21	PLW06M	LOCK WASHER 10MM
22	PH6246022	LOCKET HOUSING
23	PH6246023	NYLON WASHER 20MM
24	PH6246024	HOUSING NUT M22-1.5
25	PH6246025	TONGUE
26	PTLW05M	EXT TOOTH WASHER 6MM
27	PB02M	HEX BOLT M6-1 X 12
28	PH6246028	GUIDE SNAP
29	PH6246029	TOP PLUG
30	PH6246030	BLADE TENSIONER
31	PB02M	HEX BOLT M6-1 X 12
32	PW03M	FLAT WASHER 6MM
33	PB119M	HEX BOLT M6-1 X 60
34	PWN01M	WING NUT M6-1
35	PN01M	HEX NUT M6-1
36	PH6246036	HAND KNOB M6-1 X 58
37	PH6246037	BLADE GUIDE

REF	PART #	DESCRIPTION
38	PH6246038	GUIDE CARRIER EXTRUSION
39	PH6246039	GUIDE CARRIER MOUNT
40	PCB01M	CARRIAGE BOLT M8-1.25 X 20
41	PH6246041	SQUARE HOLE PLATE
42	PH6246042	MOUNT BLADE GUIDE
43	PW01M	FLAT WASHER 8MM
44	PN03M	HEX NUT M8-1.25
45	PH6246045	UPPER GUIDE BODY
46	PSB04M	CAP SCREW M6-1 X 10
47	PH6246047	UPPER GUIDE SHAFT
48	PH6246048	SPECIAL SCREW
49	P626	BALL BEARING P626Z
50	PW03M	FLAT WASHER 6MM
51	PH6246051	MOUNT SHAFT-1
52	PH6246052	MOUNT SHAFT-2
53	PH6246053	TENSION BRACKET FRAME
54	PH6246054	BOLT GUIDE
55	PH6246055	LOWER GUIDE SHAFT
56	PH6246056	BRACKET-BLADE GUIDE
57	PS17M	PHLP HD SCR M4-.7 X 6
58	PB83M	HEX BOLT M6-1 X 16
59	PFN02M	FLANGE NUT M6-1
60	PH6246060	LEFT RAIL-TABLE
61	PH6246061	RIGHT RAIL-TABLE
62	PRP75M	ROLL PIN 8 X 26
63	PH6246063	BUSHING
64	PH6246064	SHAFT FOR CHOPPER
65	P6203	BALL BEARING 6203Z
66	PH6246066	BRACKET FOR CHOPPER
67	PH6246067	LOWER HOUSE PLATE
68	PH6246068	BLADE COVER
69	PR05M	EXT RETAINING RING 15MM
70	PR09M	EXT RETAINING RING 20MM
71	PK34M	KEY 5 X 5 X 20
72	PK12M	KEY 5 X 5 X 30
73	PH6246073	DRIVE SHAFT

H6246 Parts List

REF	PART #	DESCRIPTION
74	PH6246074	DRIVE PULLEY
75	P6004	BALL BEARING 6004Z
76	PH6246076	BALL BEARING MOUNT PLATE
77	PW04M	FLAT WASHER 10MM
78	PFN01M	FLANGE NUT M8-1.25
79	PH6246079	LOWER WHEEL
80	PB09M	HEX BOLT M8-1.25 X 20
81	PH6246081	FLANGE
82	PH6246082	ANGLE PLATE
83	PH6246083	SEPARATE PLATE
84	PH6246084	REIN SLEEVE
85	PB03M	HEX BOLT M8-1.25 X 16
86	PW01M	FLAT WASHER 8MM
87	PB26M	HEX BOLT M8-1.25 X 30
88	PW01M	FLAT WASHER 8MM
89	PN03M	HEX NUT M8-1.25
90	PTLW07M	EXT TOOTH WASHER 8MM
91	PVA36	V-BELT A-36 4L360
92	PH6246092	BLADE 1950
93	PSB58M	CAP SCREW M8-1.25 X 12
94	PH6246094	STAND ROD (10")
95	PH6246095	SUPPORTER
96	PH6246096	WING BOLT M8-1.25 X 20
97	PH6246097	STAND ROD (7")
98	PH6246098	PUSHER
99	PH6246099	FENCE
100	PH6246100	TABLE
101	PRP73M	ROLL PIN 4 X 30
102	PSB02M	CAP SCREW M6-1 X 20
103	PB83M	HEX BOLT M6-1 X 16
104	PH6246104	LOWER GUIDE MOUNT
105	PH6246105	FLAT PIECE
106	P608	BALL BEARING 6008ZZ
107	PB28M	HEX BOLT M8-1.25 X 60
108	PH6246108	CHARGING HOPPER
109	PH6246109	SHAFT-THRUST
110	PH6246110	SQUARE HEAD SCREW M10

REF	PART #	DESCRIPTION
111	PH6246111	REAMER
112	PH6246112	FILTER COVER
113	PH6246113	LOCK COVER
114	PH6246114	PLASTIC HOPPER COVER
115	PH6246115	MEAT PUSH ROD
116	PH6246116	RUBBER TUBE CONNECTOR
117	PH6246117	FRONT PANEL STAND
118	PH6246118	REAL PANNEL STAND
119	PH6246119	LEFT PANEL STAND
120	PH6246120	RIGHT PANEL STAND
121	PH6246121	LEG
122	PH6246122	MOUNT-MOTOR
123	PH6246123	MOTOR PULLEY
124	PH6246124	RIVET 4 X 8
125	PH6246125	MOTOR 110V, 3/4HP
126	PH6246126	CHIP CONTAINER
127	PH6246127	CHIP CONTAINER RAIL-1
128	PH6246128	CHIP CONTAINER RAIL-2
129	PH6246129	SPACER BUSH
130	PW03M	FLAT WASHER 6MM
131	PB47M	HEX BOLT M6-1 X 40
132	PLW03M	LOCK WASHER 6MM
133	PN06M	HEX NUT M5-.8
134	PN18M	ACORN NUT M8-1.25
135	PS25M	PHLP HD SCR M4-.7 X 35
136	PW02M	FLAT WASHER 5MM
137	PH6246137	CLAMP-CORD
138	PH6246138	BOX-SWITCH
139	PHTEK1M	TAP SCREW M3.5 X 12
140	PHTEK29M	TAP SCREW M3.5 X 20
141	PS74M	PHLP HD SCR M4-.7 X 14
142	PTLW01M	EXT TOOTH WASHER 4MM
143	PH6246143	COVER-SWITCH
144	PH6246144	LOCK SWITCH
145	PH6246145	STRAIN-RELIEF
146	PH6246146	CORD W/ PLUG
147	PH6246147	RUBBER FOOT SHOE

Troubleshooting

Symptom	Possible Cause	Possible Solution
Motor will not start.	<ol style="list-style-type: none"> 1. Low voltage. 2. Open circuit in motor or loose connections. 	<ol style="list-style-type: none"> 1. Check power line for proper voltage. 2. Inspect all lead connections on motor for loose or open connections.
Motor will not start; fuses or circuit breakers blow.	<ol style="list-style-type: none"> 1. Short circuit in line cord or plug. 	<ol style="list-style-type: none"> 1. Repair or replace cord or plug for damaged insulation and shorted wires.
Motor fails to develop full power (output of motor decreases rapidly with decrease in voltage at motor terminals).	<ol style="list-style-type: none"> 1. Power line overloaded with lights, appliances, and other motors. 2. Undersized wires or circuits too long. 3. General overloading of power company facilities. 	<ol style="list-style-type: none"> 1. Reduce load on power line. 2. Increase wire sizes or reduce length of the circuit. 3. Request a power check from the power company.
Motor overheats.	<ol style="list-style-type: none"> 1. Motor overloaded. 2. Air circulation through the motor restricted. 	<ol style="list-style-type: none"> 1. Reduce load on motor. 2. Clean out motor to provide normal air circulation.
Motor stalls (resulting in blown fuses or tripped circuit).	<ol style="list-style-type: none"> 1. Short circuit in motor or loose connections. 2. Low voltage. 3. Incorrect fuses or circuit breakers in power line. 4. Motor overloaded. 	<ol style="list-style-type: none"> 1. Repair or replace connections on motor for loose or shorted terminals or worn insulation. 2. Correct the low voltage conditions. 3. Install correct fuses or circuit breakers. 4. Reduce load on motor.
Loud repetitious noise coming from machine.	<ol style="list-style-type: none"> 1. Pulley setscrews or keys are missing or loose. 2. Motor fan is hitting the cover. 	<ol style="list-style-type: none"> 1. Inspect keys and setscrews. Replace or tighten as needed. 2. Adjust fan cover mounting position, tighten fan, or shim fan cover.
Vibration when running or cutting.	<ol style="list-style-type: none"> 1. Loose or damaged blade. 2. Worn arbor bearings. 	<ol style="list-style-type: none"> 1. Tighten or replace blade. 2. Check/replace arbor bearings.

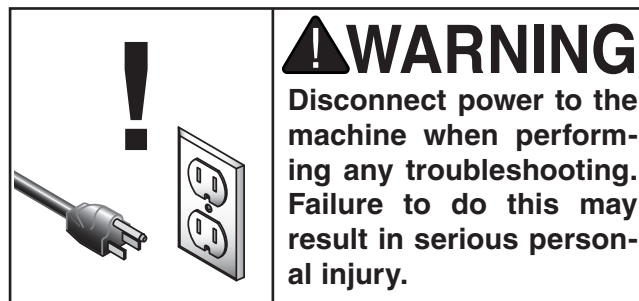

WARRANTY AND RETURNS

Grizzly Industrial, Inc. warrants every product it sells for a period of **1 year** to the original purchaser from the date of purchase. This warranty does not apply to defects due directly or indirectly to misuse, abuse, negligence, accidents, repairs or alterations or lack of maintenance. This is Grizzly's sole written warranty and any and all warranties that may be implied by law, including any merchantability or fitness, for any particular purpose, are hereby limited to the duration of this written warranty. We do not warrant or represent that the merchandise complies with the provisions of any law or acts unless the manufacturer so warrants. In no event shall Grizzly's liability under this warranty exceed the purchase price paid for the product and any legal actions brought against Grizzly shall be tried in the State of Washington, County of Whatcom.

We shall in no event be liable for death, injuries to persons or property or for incidental, contingent, special, or consequential damages arising from the use of our products.

To take advantage of this warranty, contact us by mail or phone and give us all the details. We will then issue you a "Return Number," which must be clearly posted on the outside as well as the inside of the carton. We will not accept any item back without this number. Proof of purchase must accompany the merchandise.

The manufacturers reserve the right to change specifications at any time because they constantly strive to achieve better quality equipment. We make every effort to ensure that our products meet high quality and durability standards and we hope you never need to use this warranty.

Please feel free to write or call us if you have any questions about the machine or the manual.

Thank you again for your business and continued support. We hope to serve you again soon.

WARRANTY CARD

Name _____

Street _____

City _____ State _____ Zip _____

Phone Number _____ E-Mail _____ FAX _____

MODEL: H6246 Meat Cutting Bandsaw Serial # _____ Order _____

The following information is given on a voluntary basis. It will be used for marketing purposes to help us develop better products and services. Of course, all information is strictly confidential.

CUT ALONG DOTTED LINE

1. How did you learn about us?
 Advertisement Friend
 Catalog Card Deck
 World Wide Web
 Other _____
2. Which of the following magazines do you subscribe to.
 Practical Homeowner Cabinetmaker
 Shop Notes Family Handyman
 Today's Homeowner Fine Homebuilding
 WOOD Wooden Boat
 Home Handyman Woodshop News
 Journal of Light Construction Woodsmith
 Old House Journal Woodwork
 Popular Mechanics Woodworker
 Popular Science Woodworker's Journal
 Popular Woodworking Workbench
 Other _____
3. Which of the following woodworking/remodeling shows do you watch?
 Backyard America The New Yankee Workshop
 Home Time This Old House
 The American Woodworker Woodwright's Shop
 Other _____
4. What is your annual household income?
 \$20,000-\$29,999 \$60,000-\$69,999
 \$30,000-\$39,999 \$70,000-\$79,999
 \$40,000-\$49,999 \$80,000-\$89,999
 \$50,000-\$59,999 \$90,000 +
5. What is your age group?
 20-29 50-59
 30-39 60-69
 40-49 70 +
6. How long have you been a woodworker?
 0 - 2 Years 8 - 20 Years
 2 - 8 Years 20+ Years
7. How would you rank your woodworking skills?
 Simple Advanced
 Intermediate Master Craftsman
8. What stationary woodworking tools do you own? Check all that apply.
 Air Compressor Panel Saw
 Band Saw Planer
 Drill Press Power Feeder
 Drum Sander Radial Arm Saw
 Dust Collector Shaper
 Horizontal Boring Machine Spindle Sander
 Jointer Table Saw
 Lathe Vacuum Veneer Press
 Mortiser Wide Belt Sander
 Other _____
9. How many of your woodworking machines are Grizzly? _____
10. Which benchtop tools do you own? Check all that apply.
 1" x 42" Belt Sander 6" - 8" Grinder
 5" - 8" Drill Press Mini Lathe
 8" Table Saw 10" - 12" Thickness Planer
 8" - 10" Bandsaw Scroll Saw
 Disc/Belt Sander Spindle/Belt Sander
 Mini Jointer
 Other _____
11. How many of the machines checked above are Grizzly? _____
12. Which portable/hand held power tools do you own?

13. What machines/supplies would you like Grizzly Industrial to carry?

14. What new accessories would you like Grizzly Industrial to carry?
 Builders Hardware Hand Tools
 Fasteners Wood Components
 Other _____
15. What other companies do you purchase your tools and supplies from?

16. Do you think your purchase is good value?
 Yes No
17. Would you recommend Grizzly Industrial to a friend?
 Yes No
18. Would you allow us to use your name as a reference for Grizzly customers in your area? **Note: We never use names more than three times.**
 Yes No
19. Comments: _____

FOLD ALONG DOTTED LINE



Place
Stamp
Here



GRIZZLY INDUSTRIAL, INC.
P.O. BOX 2069
BELLINGHAM, WA 98227-2069



FOLD ALONG DOTTED LINE

Send a Grizzly Catalog to a friend:

Name _____
Street _____
City _____ State _____ Zip _____

TAPE ALONG EDGES--PLEASE DO NOT STAPLE

grizzly.com

TOOL WEBSITE

Buy Direct and Save with Grizzly® – Trusted, Proven and a Great Value!

*Visit Our Website Today And Discover Why
Grizzly® Is The Industry Leader!*

- SECURE ORDERING
- ORDERS SHIPPED WITHIN 24 HOURS
- E-MAIL RESPONSE WITHIN ONE HOUR

-OR-

Call Today For A **FREE**
Full Color Catalog

1-800-523-4777



Free Manuals Download Website

<http://myh66.com>

<http://usermanuals.us>

<http://www.somanuals.com>

<http://www.4manuals.cc>

<http://www.manual-lib.com>

<http://www.404manual.com>

<http://www.luxmanual.com>

<http://aubethermostatmanual.com>

Golf course search by state

<http://golfingnear.com>

Email search by domain

<http://emailbydomain.com>

Auto manuals search

<http://auto.somanuals.com>

TV manuals search

<http://tv.somanuals.com>