

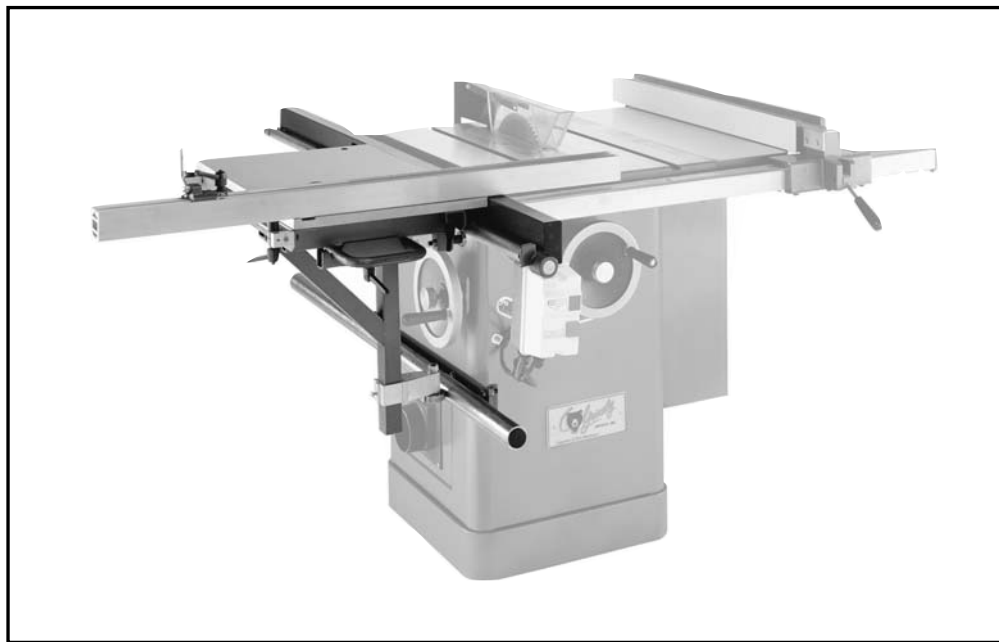

# SLIDING TABLE

## MODEL G4227

# INSTRUCTION MANUAL



COPYRIGHT © 1996 BY GRIZZLY INDUSTRIAL, INC. TX 4-344-567

**Warning: No portion of this manual may be reproduced in any shape or form without the written approval of Grizzly Industrial, Inc.**

REVISED JULY, 2002. PRINTED IN TAIWAN.

#### ONLINE MANUAL DISCLAIMER

THE INFORMATION IN THIS MANUAL REPRESENTS THE CONFIGURATION OF THE MACHINE AS IT IS CURRENTLY BEING SHIPPED. THE MACHINE CONFIGURATION CAN CHANGE AS PRODUCT IMPROVEMENTS ARE INCORPORATED. IF YOU OWN AN EARLIER VERSION OF THE MACHINE, THIS MANUAL MAY NOT EXACTLY DEPICT YOUR MACHINE. CONTACT CUSTOMER SERVICE IF YOU HAVE ANY QUESTIONS ABOUT DIFFERENCES. PREVIOUS VERSIONS ARE NOT AVAILABLE ONLINE.

# Table of Contents

	PAGE
<b>1. SAFETY RULES FOR ALL TOOLS .....</b>	<b>2-3</b>
<b>2. INTRODUCTION .....</b>	<b>4</b>
SAFETY RULES .....	4
COMMENTARY .....	4-5
UNPACKING .....	5
CLEAN UP.....	5
PIECE INVENTORY.....	5-6
OVERVIEW OF PARTS .....	6
HARDWARE RECOGNITION CHART .....	7
SITE PLANNING .....	8
ORDER OF ASSEMBLY .....	8
<b>3. INSTALLATION .....</b>	<b>9</b>
MOUNTING .....	10-14
<b>4. OPERATIONS.....</b>	<b>15</b>
GENERAL USE .....	15
TEST RUN.....	15
<b>5. MAINTENANCE .....</b>	<b>16</b>
LUBRICATION .....	16
GENERAL .....	16
<b>6. CLOSURE .....</b>	<b>17</b>
MACHINE SPECIFICATIONS .....	18
PARTS BREAKDOWN .....	19
PARTS LIST .....	20
NOTES .....	21
<b>7. WARRANTY AND RETURNS .....</b>	<b>22</b>

# SECTION 1: SAFETY

## WARNING

### For Your Own Safety Read Instruction Manual Before Operating This Equipment

The purpose of safety symbols is to attract your attention to possible hazardous conditions. This manual uses a series of symbols and signal words which are intended to convey the level of importance of the safety messages. The progression of symbols is described below. Remember that safety messages by themselves do not eliminate danger and are not a substitute for proper accident prevention measures.



Indicates an imminently hazardous situation which, if not avoided, **WILL** result in death or serious injury.



Indicates a potentially hazardous situation which, if not avoided, **COULD** result in death or serious injury.



Indicates a potentially hazardous situation which, if not avoided, **MAY** result in minor or moderate injury. It may also be used to alert against unsafe practices.

## NOTICE

This symbol is used to alert the user to useful information about proper operation of the equipment.

## WARNING

### Safety Instructions For Power Tools

- KEEP GUARDS IN PLACE** and in working order.
- REMOVE ADJUSTING KEYS AND WRENCHES.** Form habit of checking to see that keys and adjusting wrenches are removed from tool before turning on.
- KEEP WORK AREA CLEAN.** Cluttered areas and benches invite accidents.
- DON'T USE IN DANGEROUS ENVIRONMENT.** Don't use power tools in damp or wet locations, or where any flammable or noxious fumes may exist. Keep work area well lighted.
- KEEP CHILDREN AND VISITORS AWAY.** All children and visitors should be kept a safe distance from work area.
- MAKE WORKSHOP CHILD PROOF** with padlocks, master switches, or by removing starter keys.
- DON'T FORCE TOOL.** It will do the job better and safer at the rate for which it was designed.
- USE RIGHT TOOL.** Don't force tool or attachment to do a job for which it was not designed.

# WARNING

## Safety Instructions For Power Tools

9. **USE PROPER EXTENSION CORD.** Make sure your extension cord is in good condition. Conductor size should be in accordance with the chart below. The amperage rating should be listed on the motor or tool nameplate. An undersized cord will cause a drop in line voltage resulting in loss of power and overheating. Your extension cord must also contain a ground wire and plug pin. Always repair or replace extension cords if they become damaged.

Minimum Gauge for Extension Cords

AMP RATING	LENGTH		
	25ft	50ft	100ft
0-6	18	16	16
7-10	18	16	14
11-12	16	16	14
13-16	14	12	12
17-20	12	12	10
21-30	10	10	No

10. **WEAR PROPER APPAREL.** Do not wear loose clothing, gloves, neckties, rings, bracelets, or other jewelry which may get caught in moving parts. Non-slip footwear is recommended. Wear protective hair covering to contain long hair.
11. **ALWAYS USE SAFETY GLASSES.** Also use face or dust mask if cutting operation is dusty. Everyday eyeglasses only have impact resistant lenses, they are NOT safety glasses.
12. **SECURE WORK.** Use clamps or a vise to hold work when practical. It's safer than using your hand and frees both hands to operate tool.
13. **DON'T OVERREACH.** Keep proper footing and balance at all times.
14. **MAINTAIN TOOLS WITH CARE.** Keep tools sharp and clean for best and safest performance. Follow instructions for lubricating and changing accessories.
15. **USE RECOMMENDED ACCESSORIES.** Consult the owner's manual for recommended accessories. The use of improper accessories may cause risk of injury.

16. **REDUCE THE RISK OF UNINTENTIONAL STARTING.** On machines with magnetic contact starting switches there is a risk of starting if the machine is bumped or jarred. Always disconnect from power source before adjusting or servicing. Make sure switch is in OFF position before reconnecting.

17. **MANY WOODWORKING TOOLS CAN "KICKBACK" THE WORKPIECE** toward the operator if not handled properly. Know what conditions can create "kickback" and know how to avoid them. Read the manual accompanying the machine thoroughly.

18. **CHECK DAMAGED PARTS.** Before further use of the tool, a guard or other part that is damaged should be carefully checked to determine that it will operate properly and perform its intended function. Check for alignment of moving parts, binding of moving parts, breakage of parts, mounting, and any other conditions that may affect its operation. A guard or other part that is damaged should be properly repaired or replaced.

19. **NEVER LEAVE TOOL RUNNING UNATTENDED. TURN POWER OFF.** Don't leave tool until it comes to a complete stop.

20. **NEVER OPERATE A MACHINE WHEN TIRED, OR UNDER THE INFLUENCE OF DRUGS OR ALCOHOL.** Full mental alertness is required at all times when running a machine.

## CAUTION

No list of safety guidelines can be complete. Every shop environment is different. Always consider safety first, as it applies to your individual working conditions. Use this and other machinery with caution and respect. Failure to do so could result in serious personal injury, damage to equipment or poor work results.

# SECTION 2: INTRODUCTION

---

## Safety Rules

---

1. **TEST THE STABILITY OF THE MACHINE BEFORE USING.** An extended or heavy load may alter the balance point of the machine (especially if used with a mobile base). Neglecting this step could result in damage to the equipment and serious injury to the operator.
2. **KEEP FINGERTIPS AWAY FROM THE MOVING BLADES OR CUTTERS.**
3. **ALWAYS FEED THE WORK AGAINST THE DIRECTION OF ROTATION.**
4. **USE A DUST MASK OR RESPIRATOR,** even if you have a reliable method of dust collection, when cutting or shaping, as well as **EYE AND EAR PROTECTION.**
5. **DO NOT CUT IT** if there is any doubt as to the stability or integrity of the material to be cut. Look for loose knots, nails and any defect that may cause the workpiece to shift, come apart or cause blade failure.
6. **DO NOT EXTEND FINGERS BELOW THE BOTTOM OF THE FENCE NEAR THE STATIONARY TABLE.** A potential for pinched fingers exists.
7. **AVOID KICKBACKS** (work thrown back toward you) A condition in which a piece of wood is thrown back towards an operator at a high rate of speed. If you do not have a complete understanding of how kickback occurs, or how to prevent it, **DO NOT** operate this table saw.
8. **IF AT ANY TIME YOU ARE EXPERIENCING DIFFICULTIES** performing the intended operation, stop using the machine! Then contact our service department or ask a qualified expert how the operation should be performed.

9. **HABITS - GOOD AND BAD - ARE HARD TO BREAK.** Develop good habits and safety will become second nature to you.



## Commentary

---

Grizzly Industrial, Inc. is proud to offer the Model G4227 Sliding Table. The Model G4227 is part of Grizzly's growing family of fine woodworking and metalworking tools. When used according to the guidelines stated in this manual, you can expect years of trouble-free, enjoyable operation.

The Model G4227 Sliding Table provides your full-sized table saw or shaper with increased precision and convenience when milling or cross-cutting larger wood panels and flat stock. The Model G4227 Sliding Table is designed to fit the Grizzly Model G1023-series Table Saws, Model G1026 and G1035 Shapers and most other full-sized saws and shapers.

We are also pleased to provide this manual with the Model G4227. It was written to guide you through assembly, review safety considerations, and cover general operating procedures. It represents our effort to produce the best documentation possible. If you have any comments regarding this manual, please write to us at the address below:

Grizzly Industrial, Inc.  
% Technical Documentation  
P.O. Box 2069  
Bellingham, WA 98227-2069

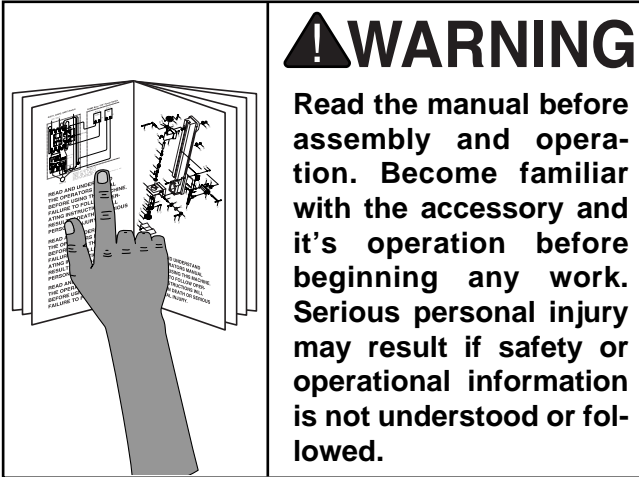

Most importantly, we stand behind our products. If you have any service questions or parts requests, please call, write or email us at the locations listed below.

Grizzly Industrial, Inc.  
 2406 Reach Road  
 Williamsport, PA 17701  
 Phone: (570) 546-9663  
 Fax: (800) 438-5901  
 E-Mail: [techsupport@grizzly.com](mailto:techsupport@grizzly.com)  
 Web Site: <http://www.grizzly.com>

The specifications, drawings, and photographs illustrated in this manual represent the Model G4227 as supplied when the manual was prepared.

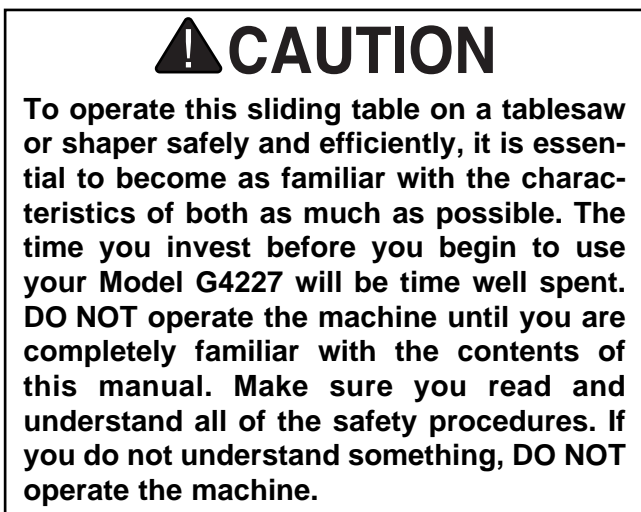

However, owing to Grizzly's policy of continuous improvement, changes may be made at any time with no obligation on the part of Grizzly. Whenever possible, though, we send manual updates to all owners of a particular tool or machine. Should you receive one, we urge you to insert the new information with the old and keep it for reference.

## Unpacking

The Model G4227 is shipped from the manufacturer in a carefully packed carton. If you discover the sliding table is damaged after you've signed for delivery, *please call Customer Service immediately for advice.*

Save the containers and all packing materials for possible inspection by the carrier or its agent. *Otherwise filing a freight claim can be difficult.*

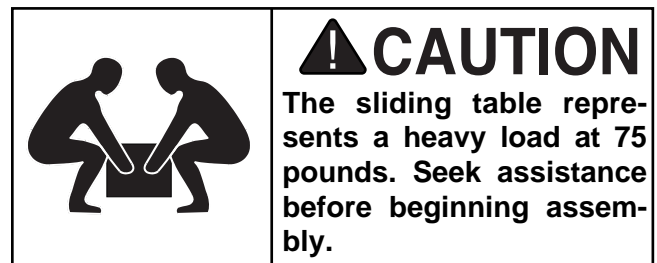

When you are completely satisfied with the condition of your shipment, you should inventory its parts.



## Clean up

The sliding table surface is coated with a plastic film that protects it from damage during shipment. Heat the film with a hair dryer and remove the protective film with great care to avoid peeling the laminate off.



# Piece Inventory

After all the parts have been removed from the carton, you should have:

- Upper Guide Rail Assembly
- Lower Guide Rail
- Lower Guide Rail Bracket
- Fence
- Sliding Table
- Sliding Table Support
- Lower Guide Bearing Assembly
- Bag of Mounting Hardware
- Bag of Assembly Hardware
- Scale
- Fence Stop Assembly
- Push Handle
- Push Handle Mounting Bracket
- Lower Bearing Guide
- Front Stop Casting

## Mounting Hardware Bag

Qty	Description
3	3/8" - 16 x 2 3/8" Cap Screws
3	M10-1.50 x 55mm Cap Screws
3	3/8" Flat Washers
3	Spacers
1	#10-24 x 3/4" Phillip® Head Screw

## Assembly Hardware Bag

Qty	Description
4	1/4" - 20 x 3/4" Cap Screws
4	1/4" Flat Washers
4	1/4" Lock Washers
1	Plastic Bumper
2	Threaded Lock Handles
1	Lock Handle With Stud
1	Steel Spacer
1	Rubber Ring
1	Rubber Stop

In the rare event that any standard hardware is missing (e.g. a nut or a washer), we would be happy to replace it, but for expediency, you will find replacements at your local hardware store. However, if an unusual amount of fasteners or proprietary parts are missing, please contact our service department.



# Overview Of Parts

The photo below, **Figure 1**, Shows all the parts provided to assemble the Model G4227 Sliding Table.

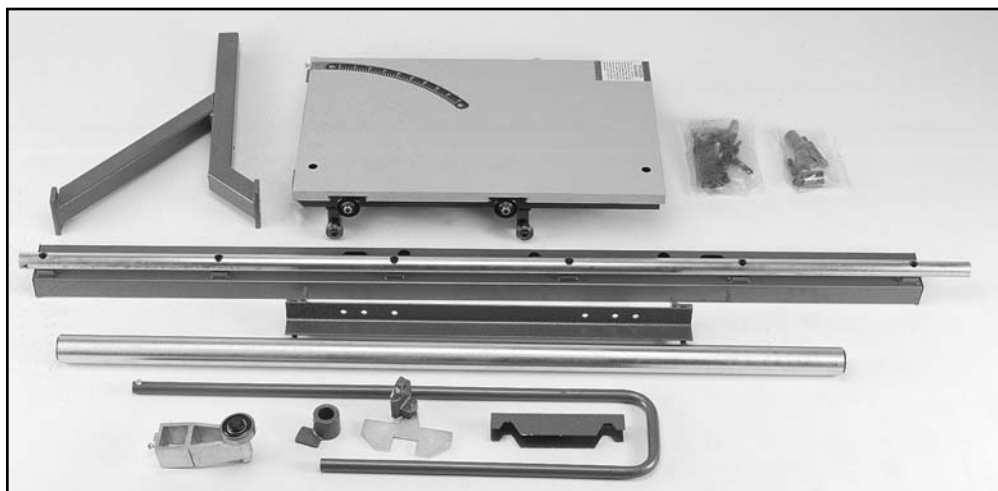

**Figure 1.** Overview of parts.

# Hardware Recognition Chart

Use this chart to match up hardware pieces during the assembly process!

MEASURE BOLT DIAMETER BY PLACING INSIDE CIRCLE

#10

1/4"

5/16"

3/8"

7/16"

1/2"

5/8"

4mm

6mm

8mm

10mm

12mm

16mm

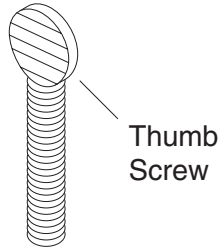

Thumb Screw

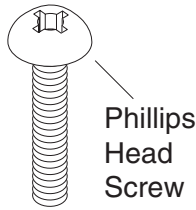

Phillips Head Screw

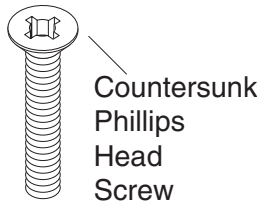

Countersunk Phillips Head Screw

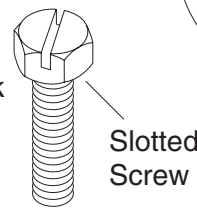

Slotted Screw

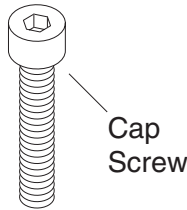

Cap Screw

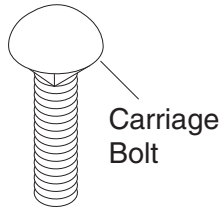

Carriage Bolt

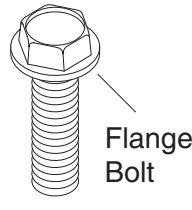

Flange Bolt

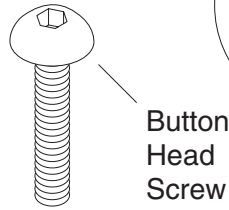

Button Head Screw



Setscrew

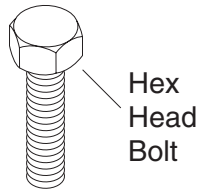

Hex Head Bolt

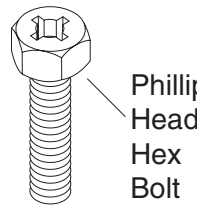

Phillips Head Hex Bolt

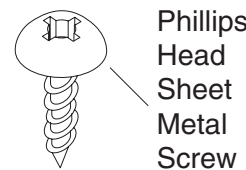

Phillips Head Sheet Metal Screw



Washer



Lock Washer

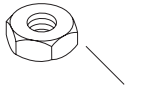

Hex Nut



Lock Nut



Wing Nut

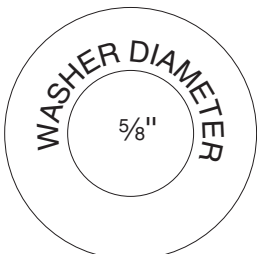

WASHER DIAMETER 5/8"

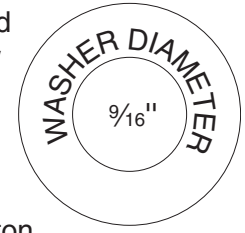

WASHER DIAMETER 9/16"

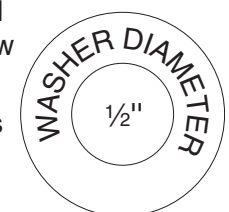

WASHER DIAMETER 1/2"



WASHER DIAMETER 7/16"

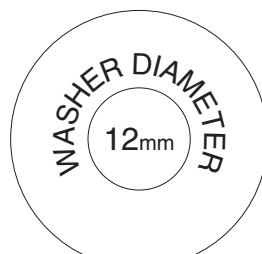

WASHER DIAMETER 12mm

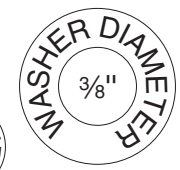

WASHER DIAMETER 3/8"



4mm

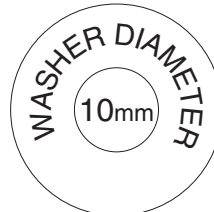

WASHER DIAMETER 10mm



WASHER DIAMETER 5/16"

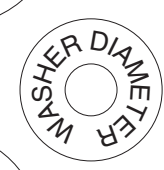

6mm

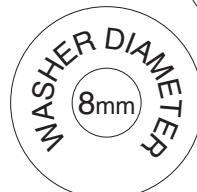

WASHER DIAMETER 8mm



WASHER DIAMETER 1/4"



#10

LINES ARE 1MM APART

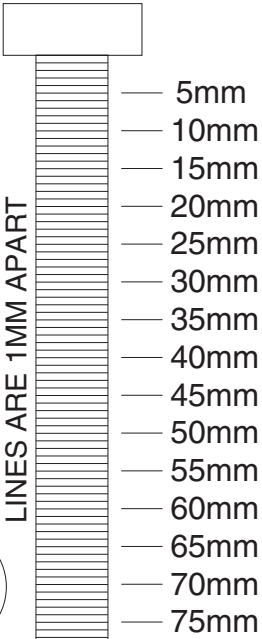

1/4"  
3/8"  
1/2"  
5/8"

LINES ARE 1/16" INCH APART

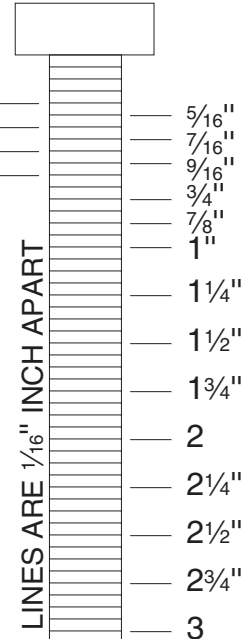

WASHERS ARE MEASURED BY THE INSIDE DIAMETER



# Site Planning

---

---

When placing the Model G4227 Sliding Table in your shop, two major considerations should be addressed: working clearances and lighting.

1. Working clearances can be defined as the safe distance between other machines and obstacles that may limit material being processed or person(s) operating those machines. Consider existing and anticipated machine needs, anticipated size of material to be processed through each machine, and space for auxiliary stands and/or work tables. You may also want to consider the relative position of each machine to one another for efficient material handling. Be sure to allow yourself sufficient room to safely operate your machines **in any foreseeable operation**.
2. Lighting should be bright enough to eliminate shadow and prevent eye strain. Electrical circuits should be dedicated or large enough to handle motor amp loads and proper lighting. Outlets should be located near each machine so power or extension cords are not obstructing high-traffic areas. Be sure to observe local electrical codes for proper installation if you are adding new lighting, outlets, or circuits.



# Order Of Assembly

---

---

The sliding table only requires minimal assembly and will go together quickly. Assemble in the following order:

1. Mount the upper rail to the machine.
2. Mount the lower guide bracket to the machine.
3. Assemble and mount the sliding table assembly.
4. Attach the fence.

## TOOLS REQUIRED

Only a few common tools are required to assemble your sliding table. Specifically, these are: Phillips® head screwdriver, 3mm, 5mm and 10mm Allen® wrenches, 14mm and 17mm open end wrenches.

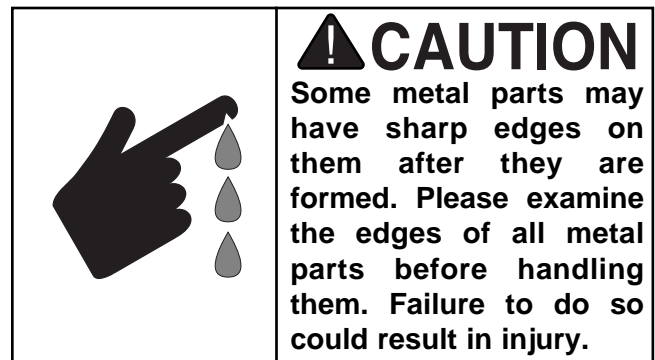

# SECTION 3: INSTALLATION

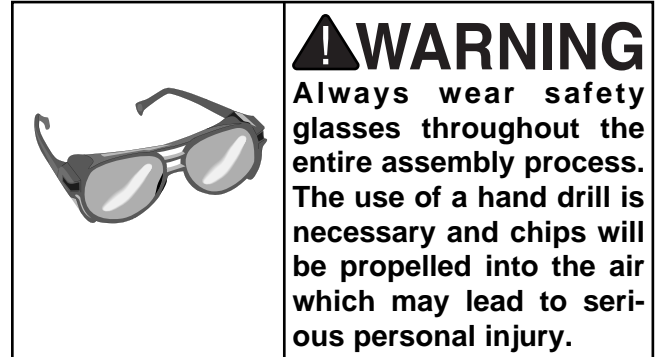
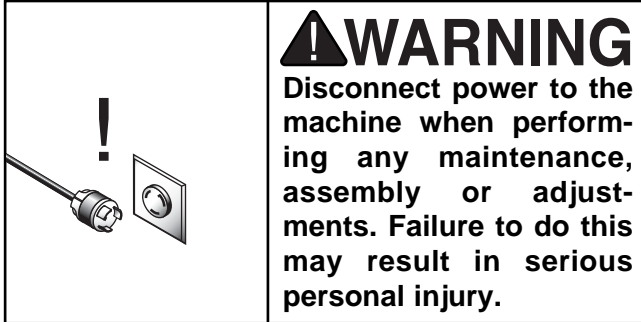

## Mounting

1. Remove the fence and fence rails from your table saw. Remove the left wing of your table saw or the front wing of your shaper. The front and rear fence rails can only extend 1" past the left side of the machine table. They will require trimming before reinstalling.
2. Attach the upper guide rail to the machine through the extension wing mounting holes. Use the cap screws and spacers supplied and install the spacers between the machine table and upper guide rail. **NOTE:** The sliding table is supplied with two different size



Figure 2. Aligning the upper rail.

mounting cap screws,  $\frac{3}{8}$ "-16 x 2 $\frac{3}{8}$ " and M10-1.50 x 55mm. If your machine has a different thread than listed here, you will need to obtain bolts from your local hardware store. Make sure the threaded portion is at least 2 $\frac{3}{8}$ " long.

3. Adjust the upper guide rail  $\frac{1}{8}$ " below the surface of your machine's table. Measure from the upper rail to the floor at both ends to achieve parallelism. Tighten the cap screws when the rail is properly adjusted. **Figure 2.**
4. To mount the lower guide rail bracket, refer to the drill guide sheet on **page 14** for proper hole locations. Drill two pilot holes using a  $\frac{1}{8}$ " drill bit then finish with a  $\frac{3}{8}$ " drill bit. **Figure 3.** Please note that Grizzly machines are pre-drilled.



Figure 3. Drilling the mounting holes.

5. Install the lower guide rail bracket to the stand/cabinet, using the two  $\frac{5}{16}$ "-18 x  $\frac{3}{4}$ " hex bolts, hex nuts and flat washers supplied. **Figure 4.**

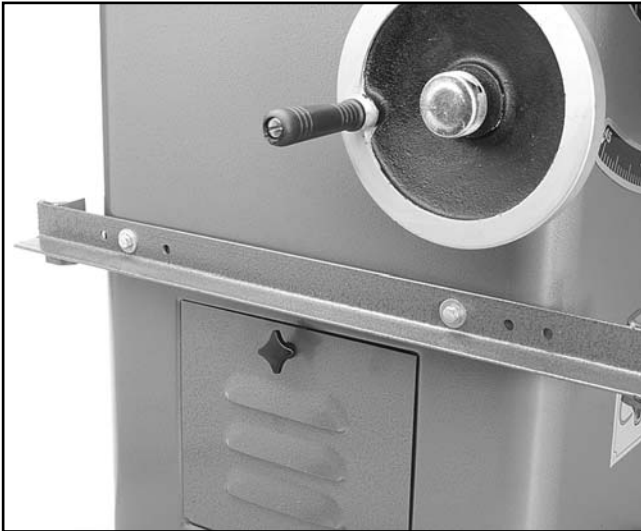

**Figure 4.** Mounting lower guide rail bracket.

6. Thread the mounting studs into the lower rail approx.  $\frac{1}{2}$ ". Attach the lower rail to its mounting bracket. **Figure 5.**



**Figure 5.** Mounting the lower rail.

7. Adjust the lower rail so its centerline is approximately even with the edge of the upper guide rail bracket. **Figure 6.**

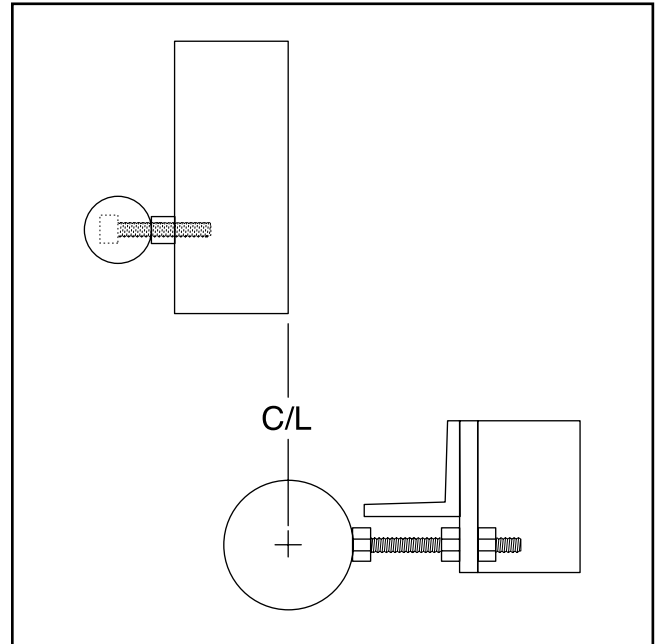

**Figure 6.** Lower rail alignment.

8. With the sliding table upside down, mount the guide bearing bracket arm using the four  $\frac{1}{4}$ "-20 x  $\frac{3}{4}$ " cap screws, flat washers and lock washers provided. **Figure 7.** Lift up on the bracket arm while tightening to ensure the cap screws will be at the end of the slot. If this detail is overlooked, the head of the cap screws will not allow the fence to swing to  $45^\circ$ .

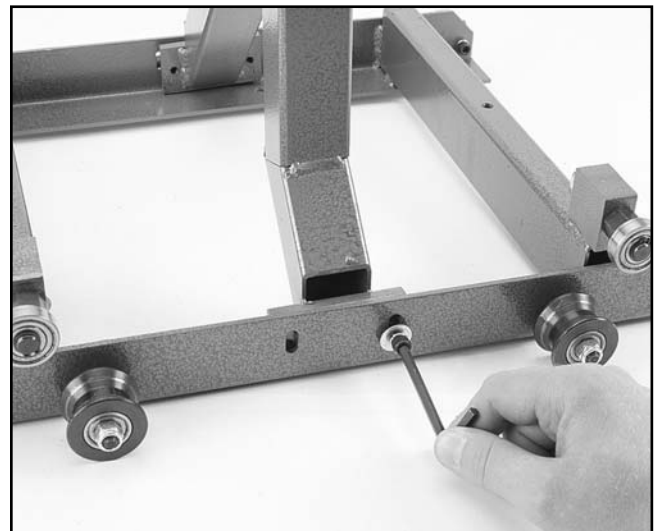

**Figure 7.** Mounting the bracket.

9. Slide the table mechanism onto the rails. Adjust the lower bearing guide until it is centered on the lower guide rail as in **Figure 8**. Please note: the upper grooved rollers can be easily derailed at this point (see **Figure 12**).



**Figure 8.** Adjust lower guide bearing.

10. Slide the rubber ring onto the front rail and install the front stop assembly. **Figure 9**.

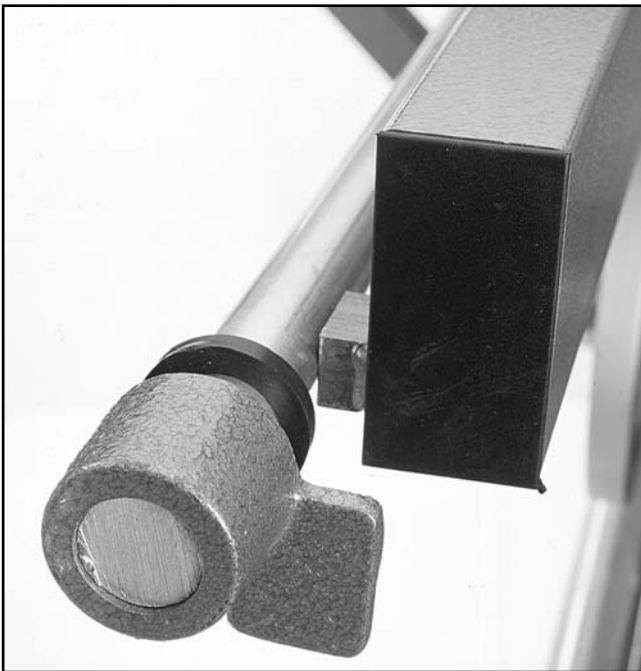

**Figure 9.** Front stop installation.

11. Install the rear stop using the #10-24 x 3/4" Phillip head screw provided. **Figure 10**.



**Figure 10.** Rear stop installation.

12. Slightly loosen the lower front and rear pinch roller nuts with a 14mm wrench. Now turn their eccentric shafts with a 17mm wrench until they are at their lowest position. **Figure 11**.

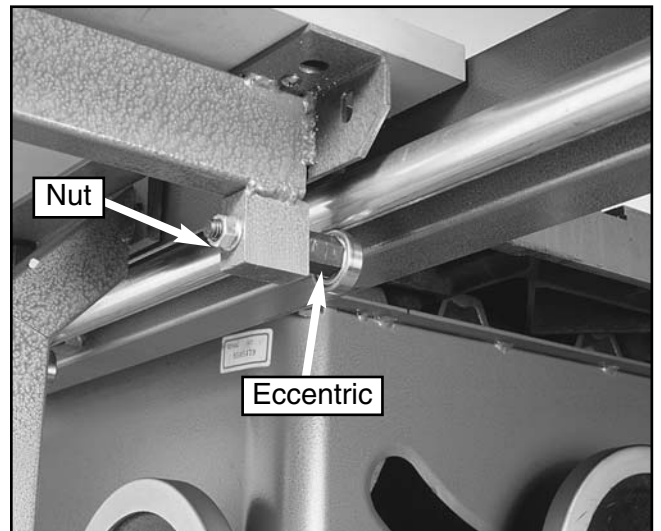

**Figure 11.** Lower pinch roller adjustment.

13. Prior to adjusting the upper eccentric grooved rollers, it must be understood that the grooved rollers need to remain in full contact with the upper rail during the adjustment process in order to achieve proper adjustment. **Figure 12**.

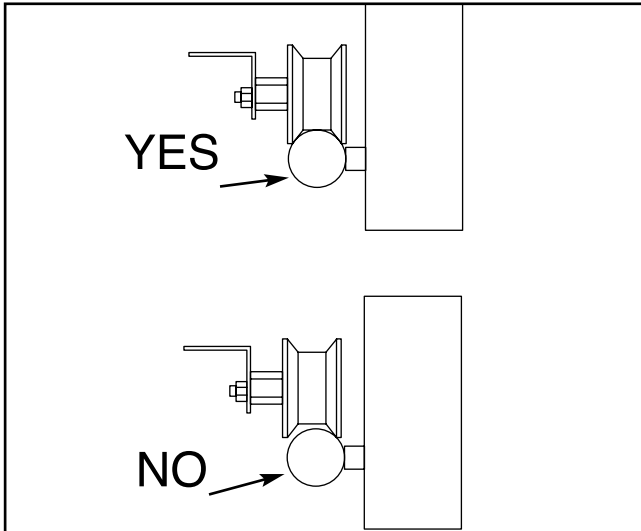

Figure 12.

14. Now loosen the eccentric roller shaft nuts slightly and rotate the eccentric shafts until the sliding table is about  $\frac{1}{16}$ " above the machine table. Tighten the nuts down and recheck the sliding table height. Fine tune the table height by turning the upper grooved roller eccentric shafts without loosening the nut. **Figure 13.**

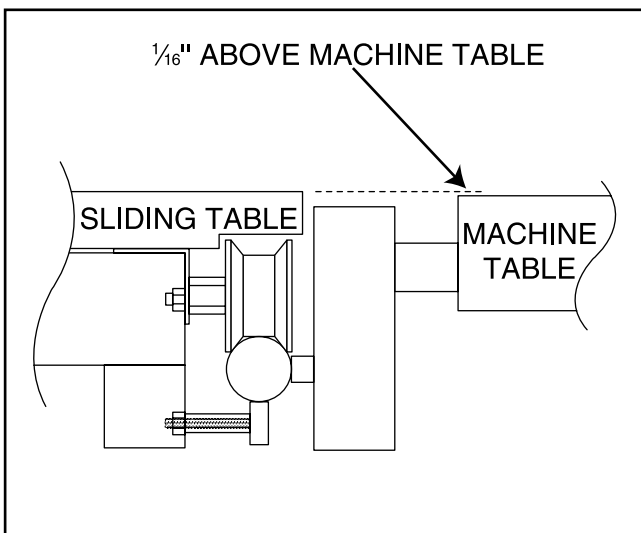

Figure 13. Roller adjustment.

15. Raise the pinch rollers back up and tighten the nuts. Roll back the eccentric slightly if the table travel is stiff.
16. Mount the fence by sliding the plastic T-nuts into the bottom of the fence. Insert the short stud into the hole closest to the machine table, the longer stud with spacer goes through the sliding mount. **Figure 14.** Install the lock handles from below.

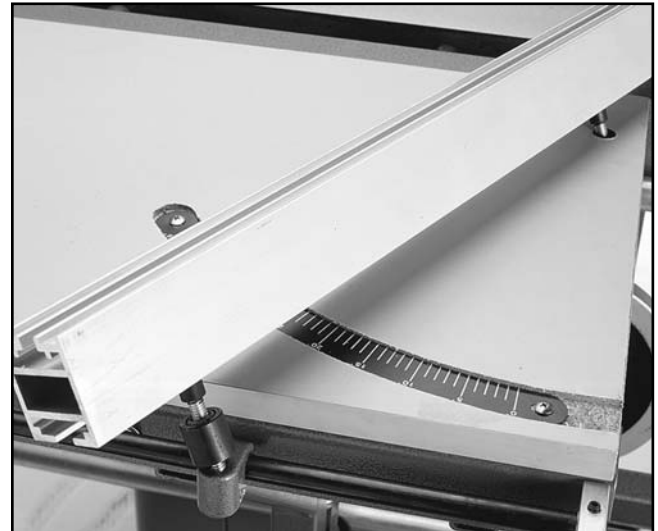

Figure 14. Mounting the fence.

17. Set the sliding table fence so it extends to the saw blade or shaper fence. **Figure 15.** Loosen the lower bearing guide shaft nut and rotate the eccentric shaft from below the bearing until the end of the fence almost touches the machine table. Retighten the nut. **NOTE:** If the eccentric does not provide sufficient travel, the threaded mounting studs on the lower guide rail assembly can be adjusted by turning the nuts on either side of the bracket.



Figure 15. Adjusting the lower guide.

18. Now, set the fence to 0° by placing a square between the miter slot and the fence. The stop bolt can be adjusted to ensure the fence will return to 90° after it has been moved. **Figure 16.**



**Figure 16.** Adjusting positive stop.

19. Next, apply the self adhesive scale in the top front groove of the fence and install the adjustable fence stop. **Figure 17.**

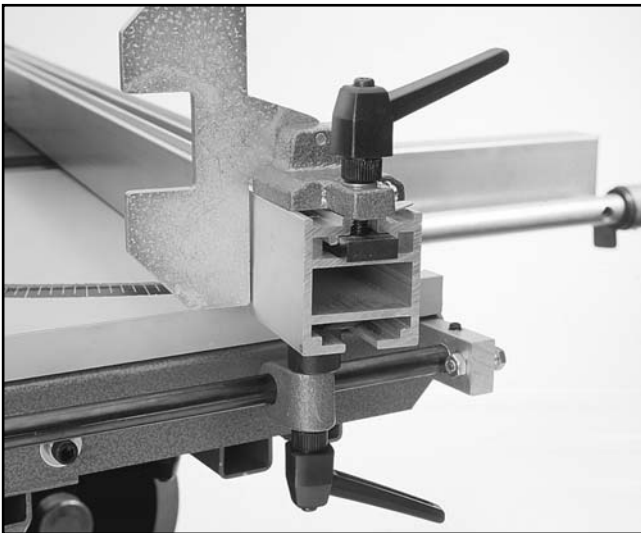

**Figure 17.** Installing fence stop.

20. Mount the auxiliary handle by removing the stop bolt from the handle, slide the long portion of the handle through the guiding hole at the bottom/rear of the sliding table. Attach the pinch bracket to the bottom/front of the table using the lock handle with stud. **Figure 18.**



**Figure 18.** Installing auxiliary handle.

21. The fence can also be mounted at the rear of the sliding table in the same manner as it attaches in the front. **Figure 20.** Adjust the fence perpendicular to the blade/fence by loosening the setscrew and rotating the eccentric bushing.

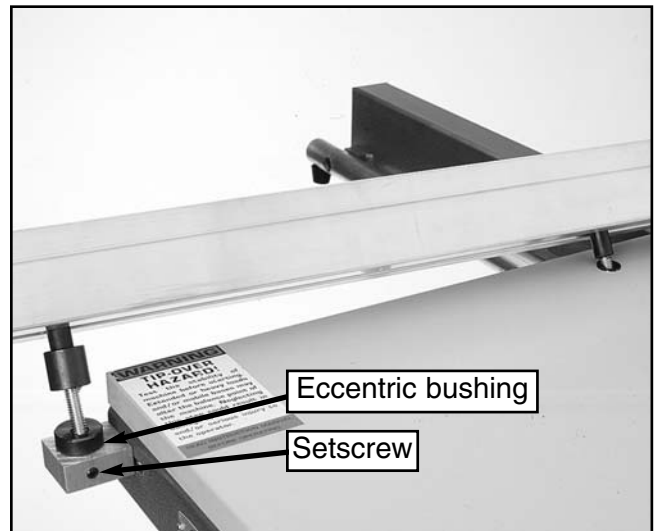
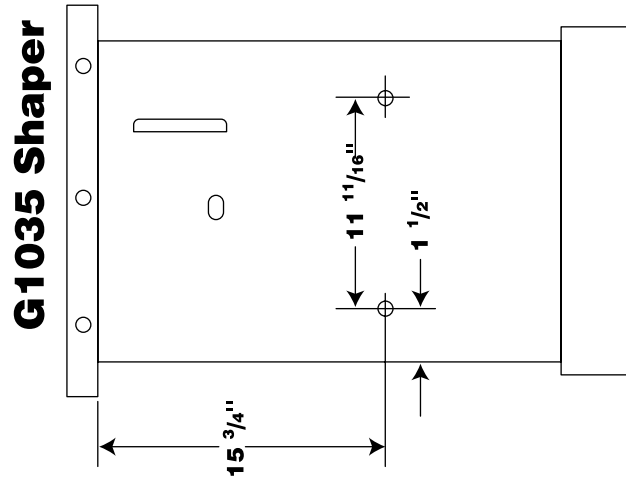
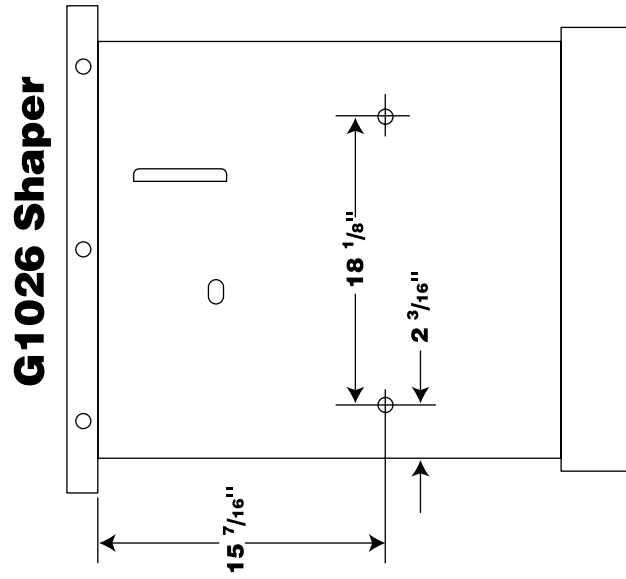
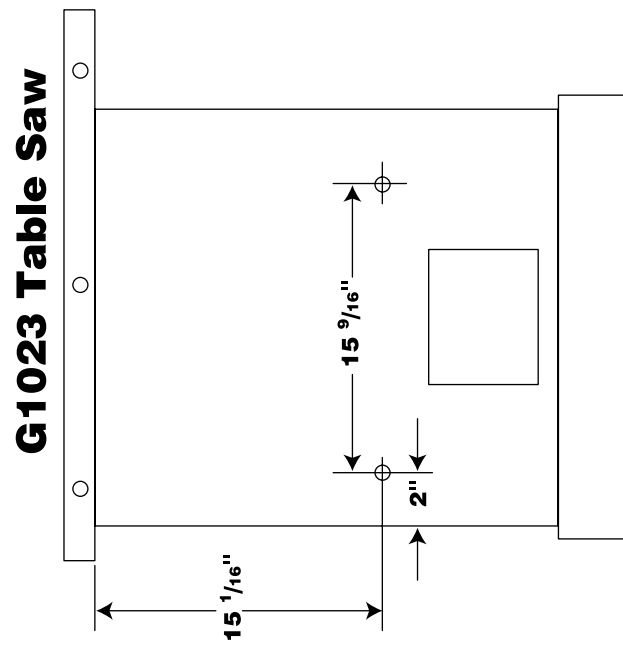

**Figure 19.** Optional fence position.

22. Remount your fence rails to your table saw for ripping operations. It will be necessary to cut the left ends of the front and rear rails so they will fit with the sliding table top rail. A hacksaw and file will do nicely. **NOTE:** On saws with rail mounted switches, the switch may need to be relocated to another convenient location. For safety reasons, **Do Not** mount the switch in a hard to reach location.



## G4227 Sliding Table Mounting Guide for G1023, G1026 and G1035.



# SECTION 4: OPERATIONS

## General Use

The Model G4227 Sliding Table, when attached to your table saw or shaper, allows you to easily handle cumbersome material when crosscutting or cross shaping. The sliding table fence safely supports your work which is guided on rails and ball-bearing rollers. The fence has a large bearing surface and can be adjusted from any angle between 90° and 45°. For repetitive cutting, the fence also has a variable positioning stop block that can be flipped out of the way when not needed. The fence can also be adjusted out of the way when ripping or doing standard shaping operations.

The Model G4227 Sliding Table replaces the miter gauge function. To crosscut or cross shape:

1. Ensure that the Model G4227 is properly adjusted on your machine.
2. Move the rip fence completely out of the way.
3. Set the angle of the sliding table fence to the desired angle of cut.
4. Without turning on the table saw or shaper, slide the table and fence in the direction of the cut. Adjust the fence toward or away from the blade or cutter so that your workpiece will be adequately supported near the blade or cutter, but will not touch the blade or cutter. If full support of the workpiece is desired to minimize tear out, an auxiliary wood fence that extends out past the fence can be mounted to the sliding table fence.
5. Place your workpiece on the sliding table and against the fence at the desired distance from the blade or cutter.
6. Ensure that all safety rules are observed. Turn the table saw or shaper on and guide the sliding table through the cut with one hand on the sliding table handle and the other hand securing the workpiece against the fence.
7. Once the cut has been made, turn the table saw or shaper off.



## Test Run

Before you put your Sliding Table into use, let's give it a quick inspection.

1. Are all fasteners tight?
2. Has the sliding table been adjusted according to the guidelines set forth in this manual?
3. Have you read all safety rules?

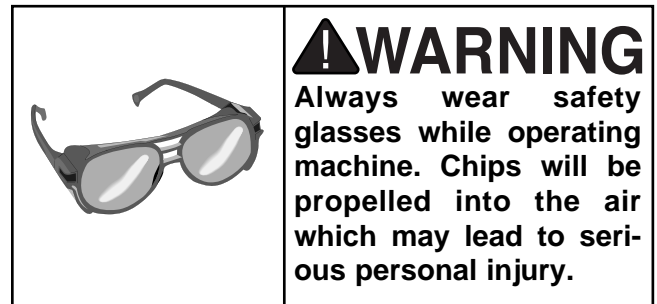



# SECTION 5: MAINTENANCE

---

---

## Lubrication

---

---

Your sliding table is equipped with shielded and pre-lubricated ball bearings that require no lubrication for the life of the bearings. All bearings are common sizes and are readily available from a local bearing supply house or through the Grizzly Industrial parts department.



## General

---

---

Make a habit of inspecting your sliding table each time you use it. Check for loose bolts. Vacuuming the sliding table clean after every use ensures that sawdust won't trap moisture against bare metal surfaces. Clean the upper rollers, lower rollers and the guide rails with steel wool about every 6 months to prevent excessive pitch build up.



# SECTION 6: CLOSURE

## Commentary

The following pages contain a parts diagram, parts list and Warranty/Return information for your Model G4227 Sliding Table.

If you need parts or help in assembling your sliding table, or if you need operational information, we encourage you to call our Service Department. Our trained service technicians will be glad to help you.

If you have comments dealing specifically with this manual, please write to our Bellingham, Washington location using the address in **Section 3: Introduction**. The specifications, drawings, and photographs illustrated in this manual represent the Model G4227 as supplied when the manual was prepared. However, due to Grizzly's policy of continuous improvement, changes may be made at any time with no obligation on the part of Grizzly. Whenever possible, though, we send manual updates to all owners of a particular tool or machine. Should you receive one, add the new information to this manual and keep it for reference.

We have included some important safety measures that are essential to this machine's operation. While most safety measures are generally

universal, Grizzly reminds you that each workshop is different and safety rules should be considered *as they apply to your specific situation*.

We recommend you keep a copy of our current catalog for complete information regarding Grizzly's warranty and return policy. If you need additional technical information relating to this machine, or if you need general assistance or replacement parts, please contact the appropriate regional Service Department listed in the **Section 3: Introduction**.

Additional information sources are necessary to realize the full potential of this sliding table. Trade journals, woodworking magazines, and the shelves of your local library are good places to start. Knowledge and caution are vital components of successful operation.

### **WARNING**

Operating this equipment has the potential for flying debris to cause eye injury. Always wear safety glasses or goggles when operating equipment. Everyday glasses or reading glasses only have impact resistant lenses, they are not safety glasses. Be certain the safety glasses you wear meet the appropriate standards of the American National Standards Institute (ANSI).

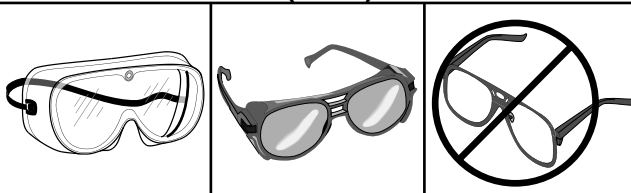

G4227 Sliding Table

### **WARNING**

The Model G4227 was specifically designed for use with table saws and shapers. **DO NOT MODIFY AND/OR USE THIS ACCESSORY FOR ANY OTHER PURPOSE.** Modifications or improper use of this unit will void the warranty. If you are confused about any aspect of this accessory, **DO NOT** use it until all your questions have been answered. Serious personal injury may occur.

### **WARNING**

As with all table saws and shapers, there is the potential for danger when using the Model G4227 Sliding Table. Use the table saw or shaper with respect and caution to lessen the possibility of operator injury or mechanical damage. If normal safety precautions are overlooked or ignored, serious injury to the operator or others in the area is possible.





# MACHINE DATA SHEET

Customer Service #: (570) 546-9663 • To Order Call: (800) 523-4777 • Fax #: (800) 438-5901

## GRIZZLY MODEL G4227 SLIDING TABLE

Design Type.....Rails with Ball Bearing Rollers

**Overall Dimensions:**

- Table Size .....15<sup>3</sup>/<sub>4</sub>" x 22"
- Fence Size .....2" x 2" x 42"
- Fence Positions .....Front 0° - 45°  
.....Back 0°
- Typical Cross Cut Capacity .....26"
- Total Travel .....48"
- Weight (Net) .....85 lbs.
- Weight (Shipping).....90 lbs.

**Construction**

- Table .....Composite Wood
- Body Assembly .....Steel
- Fence .....Aluminum

**Mounting Requirements for Table saws:** (G1023S, G1023Z, G1023ZX)

- Remove Left Extension Wing
- Trim Fence Rails Left of the Blade
- Relocate the Switch
- Drill Mounting Holes in the Cabinet

**Mounting Requirements for Shapers:** (G1035, G1026)

- Remove Table Wing (If Applicable)
- Drill Holes in Cabinet

*Specifications, while deemed accurate, are not guaranteed.*

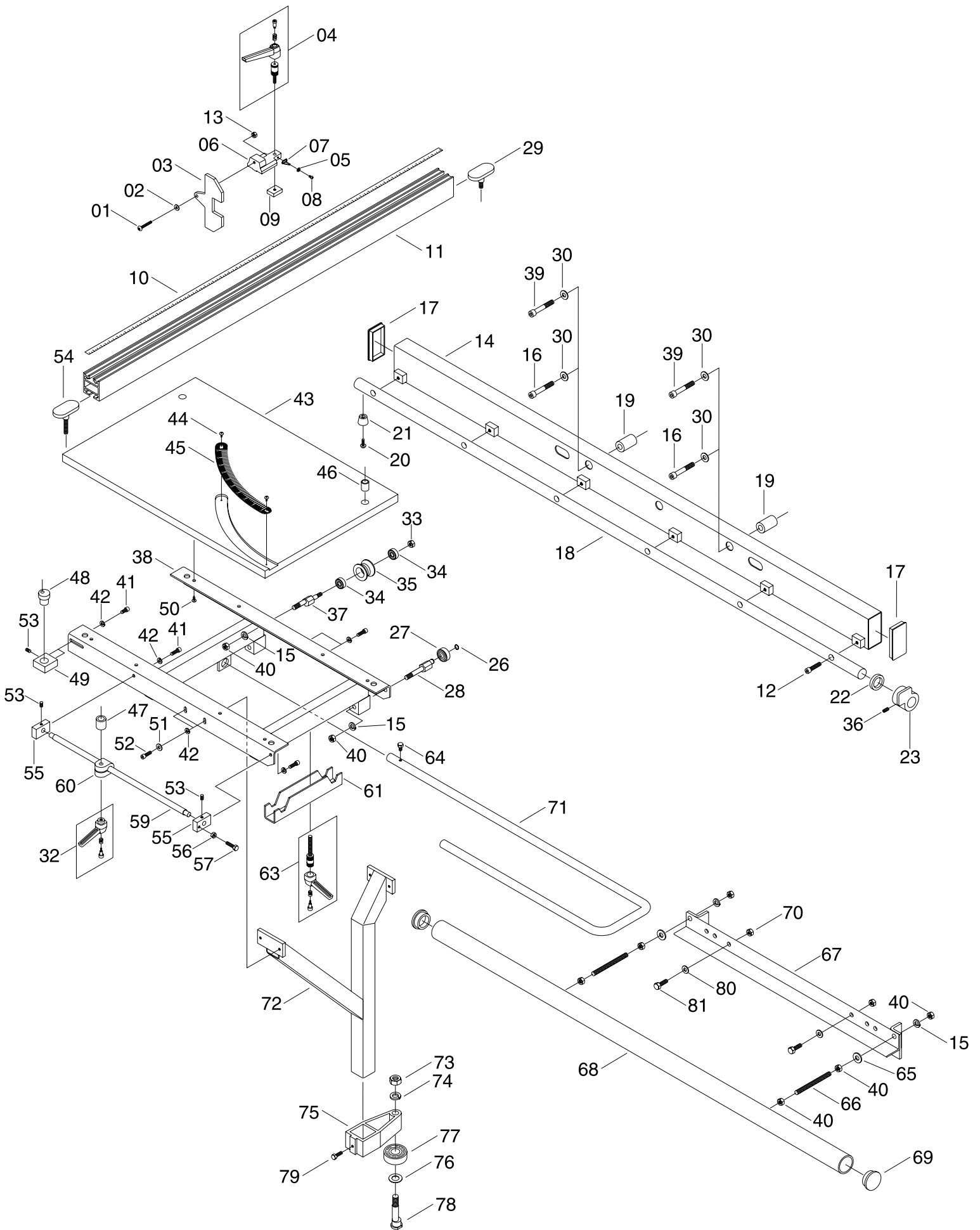

G4227 Sliding Table

REF	PART #	DESCRIPTION
1	PS13	PHLP HD SCR 10-24 X 1¼"
2	PW03	FLAT WASHER #10
3	P4227003	STOP
4	P4227004	LOCK HANDLE
5	PW16	FLAT WASHER #6
6	P4227006	STOP BRACKET
7	P4227007	POINTER
8	PS16	PHLP HD SCR 6-32 X ¼"
9	P4227009	GIB BOLT
10	P4227010	SCALE
11	P4227011	FENCE
12	PSB11	CAP SCREW 5/16"-18 X 1¼"
13	PN07	HEX NUT 10-24
14	P4227014	TOP RAIL BRACKET
15	PLW04	LOCK WASHER 3/8"
16	P4227016	CAP SCREW 3/8"- 16 X 23/8"
17	P4227017	END CAP
18	P4227018	TOP RAIL
19	P4227019	SPACER
20	PS22	PHLP HD SCREW 10-24 X 5/8"
21	P4227021	IDLER WHEEL W/BUSHING
22	P4227022	RUBBER RING
23	P4227023	FRONT STOP
26	PR01M	SNAP RING 10MM
27	P6200	BEARING 6200-2RS
28	P4227028	BEARING SHAFT
29	P4227029	T-BOLT, SHORT
30	PW02	FLAT WASHER 3/8"
32	P4227032	LOCK HANDLE
33	PLW03	LOCK NUT 5/16" - 18
34	P609	BEARING 609-2RS
35	P4227035	V-ROLLER
36	PSS03	SETSCREW ¼"-20 x 3/8"
37	P4227037	ECCENTRIC SHAFT
38	P4227038	TABLE FRAME
39	P4227039	CAP SCREW M10-1.5 x 55
40	PN08	HEX NUT 3/8" - 16
41	PSB04	CAP SCREW ¼" - 20 x ½"

REF	PART #	DESCRIPTION
42	PLW02	LOCK WASHER ¼"
43	P4227043	WORK TABLE
44	P4227044	SCREW 3/8"
45	P4227045	DEGREE SCALE
46	P4227045	BUSHING
47	P4227047	SPACER
48	P4227048	ECCENTRIC BUSHING
49	P4227048	BUSHING MOUNT BRACKET
50	P4227050	SCREW ½"
51	PW06	FLAT WASHER ¼"
52	PSB05	CAP SCREW ¼"-20 X 3/4"
53	PSS03	SETSCREW ¼"-20 X 3/8"
54	P4227054	T-BOLT, LONG
55	P4227055	BRACKET
56	PN05	HEX NUT ¼"-20
57	PB31	HEX BOLT ¼"-20 X 1"
59	P4227059	SHAFT
60	P4227060	SLIDING BRACKET
61	P4227061	LOCKING BRACKET
63	P4227063	LOCK HANDLE
64	PB51	HEX BOLT ¼"-20 X 3/8"
65	PW02	FLAT WASHER 3/8"
66	P4227066	STUD
67	P4227067	BOTTOM BRACKET
68	P4227068	BOTTOM RAIL
69	P4227069	PLUG
70	PN02	HEX NUT 5/16"-18
71	P4227071	HANDLE
72	P4227072	SUPPORT BRACKET
73	PN13	HEX NUT ½"-13
74	PLW07	LOCK WASHER ½"
75	P4227075	BEARING BRACKET
76	P4227076	SPACER
77	P6304	BEARING 6304-2RS
78	P4227078	AXLE
79	PB05	HEX BOLT ¼"-20 X 3/4"
80	PW07	FLAT WASHER 5/16"
81	PB03	HEX BOLT 3/4"-18 X 1"

# Notes

---

---

# SECTION 7: Warranty and Returns

---

---

Grizzly Industrial, Inc. warrants every product it sells for a period of **1 year** to the original purchaser from the date of purchase. This warranty does not apply to defects due directly or indirectly to misuse, abuse, negligence, accidents, repairs or alterations or lack of maintenance. This is Grizzly's sole written warranty and any and all warranties that may be implied by law, including any merchantability or fitness, for any particular purpose, are hereby limited to the duration of this written warranty. We do not warrant or represent that the merchandise complies with the provisions of any law or acts unless the manufacturer so warrants. In no event shall Grizzly's liability under this warranty exceed the purchase price paid for the product and any legal actions brought against Grizzly shall be tried in the State of Washington, County of Whatcom.

We shall in no event be liable for death, injuries to persons or property or for incidental, contingent, special, or consequential damages arising from the use of our products.

To take advantage of this warranty, contact us by mail or phone and give us all the details. We will then issue you a "Return Number," which must be clearly posted on the outside as well as the inside of the carton. We will not accept any item back without this number. Proof of purchase must accompany the merchandise.

The manufacturers reserve the right to change specifications at any time because they constantly strive to achieve better quality equipment. We make every effort to ensure that our products meet high quality and durability standards and we hope you never need to use this warranty.

Please feel free to write or call us if you have any questions about the machine or the manual.

Thank you again for your business and continued support. We hope to serve you again soon.

# WARRANTY CARD

Name \_\_\_\_\_  
Street \_\_\_\_\_  
City \_\_\_\_\_ State \_\_\_\_\_ Zip \_\_\_\_\_  
Phone Number \_\_\_\_\_ E-Mail \_\_\_\_\_ FAX \_\_\_\_\_  
MODEL # \_\_\_\_\_ Order # \_\_\_\_\_ Serial # \_\_\_\_\_

The following information is given on a voluntary basis. It will be used for marketing purposes to help us develop better products and services. Of course, all information is strictly confidential.

- How did you learn about us?  
 Advertisement                       Friend  
 Catalog                                 Card Deck  
 World Wide Web  
 Other \_\_\_\_\_
- Which of the following magazines do you subscribe to.  
 American Woodworker                 Practical Homeowner  
 Cabinetmaker                          Shop Notes  
 Family Handyman                     Today's Homeowner  
 Fine Homebuilding                    WOOD  
 Fine Woodworking                    Wooden Boat  
 Home Handyman                       Woodshop News  
 Journal of Light Construction       Woodsmith  
 Old House Journal                    Woodwork  
 Popular Mechanics                    Woodworker  
 Popular Science                       Woodworker's Journal  
 Popular Woodworking                Workbench  
 Other \_\_\_\_\_
- Which of the following woodworking/remodeling shows do you watch?  
 Backyard America                    The New Yankee Workshop  
 Home Time                              This Old House  
 The American Woodworker          Woodwright's Shop  
 Other \_\_\_\_\_
- What is your annual household income?  
 \$20,000-\$29,999                       \$60,000-\$69,999  
 \$30,000-\$39,999                       \$70,000-\$79,999  
 \$40,000-\$49,999                       \$80,000-\$89,999  
 \$50,000-\$59,999                       \$90,000 +
- What is your age group?  
 20-29                                       50-59  
 30-39                                       60-69  
 40-49                                       70 +
- How long have you been a woodworker?  
 0 - 2 Years                               8 - 20 Years  
 2 - 8 Years                               20+ Years
- How would you rank your woodworking skills?  
 Simple                                       Advanced  
 Intermediate                               Master Craftsman
- What stationary woodworking tools do you own? Check all that apply.  
 Air Compressor                         Panel Saw  
 Band Saw                                  Planer  
 Drill Press                                Power Feeder  
 Drum Sander                             Radial Arm Saw  
 Dust Collector                          Shaper  
 Horizontal Boring Machine           Spindle Sander  
 Jointer                                    Table Saw  
 Lathe                                       Vacuum Veneer Press  
 Mortiser                                  Wide Belt Sander  
 Other \_\_\_\_\_
- How many of your woodworking machines are Grizzly? \_\_\_\_\_
- Which benchtop tools do you own? Check all that apply.  
 1" x 42" Belt Sander                    6" - 8" Grinder  
 5" - 8" Drill Press                     Mini Lathe  
 8" Table Saw                            10" - 12" Thickness Planer  
 8" - 10" Bandsaw                     Scroll Saw  
 Disc/Belt Sander                       Spindle/Belt Sander  
 Mini Jointer  
 Other \_\_\_\_\_
- How many of the machines checked above are Grizzly? \_\_\_\_\_
- Which portable/hand held power tools do you own? Check all that apply.  
 Belt Sander                               Orbital Sander  
 Biscuit Joiner                          Palm Sander  
 Circular Saw                              Portable Planer  
 Detail Sander                           Saber Saw  
 Drill/Driver                              Reciprocating Saw  
 Miter Saw                                 Router  
 Other \_\_\_\_\_
- What machines/supplies would you like Grizzly Industrial to carry?  
\_\_\_\_\_  
\_\_\_\_\_
- What new accessories would you like Grizzly Industrial to carry?  
\_\_\_\_\_  
\_\_\_\_\_
- What other companies do you purchase your tools and supplies from?  
\_\_\_\_\_  
\_\_\_\_\_
- Do you think your purchase represents good value?  
 Yes     No
- Would you recommend Grizzly Industrial to a friend?  
 Yes     No
- Would you allow us to use your name as a reference for Grizzly customers in your area? **Note: We never use names more than three times.**  
 Yes     No
- Comments: \_\_\_\_\_  
\_\_\_\_\_  
\_\_\_\_\_  
\_\_\_\_\_



FOLD ALONG DOTTED LINE

---

---

---



Place  
Stamp  
Here



**GRIZZLY INDUSTRIAL, INC.**  
**P.O. BOX 2069**  
**BELLINGHAM, WA 98227-2069**



FOLD ALONG DOTTED LINE

Send a Grizzly Catalog to a friend:

Name _____
Street _____
City _____ State _____ Zip _____

TAPE ALONG EDGES--PLEASE DO NOT STAPLE





## Free Manuals Download Website

<http://myh66.com>

<http://usermanuals.us>

<http://www.somanuals.com>

<http://www.4manuals.cc>

<http://www.manual-lib.com>

<http://www.404manual.com>

<http://www.luxmanual.com>

<http://aubethermostatmanual.com>

Golf course search by state

<http://golfingnear.com>

Email search by domain

<http://emailbydomain.com>

Auto manuals search

<http://auto.somanuals.com>

TV manuals search

<http://tv.somanuals.com>