



# MODEL H6192 RANDOM ORBITAL SANDER INSTRUCTION SHEET

## ⚠ WARNING



**EYE INJURY HAZARD!**  
Always wear safety glasses when using this tool to prevent serious personal injury.



**DUST HAZARD!**  
Always wear respirator when using this tool.

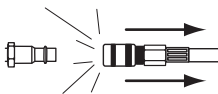

**INJURY HAZARD!**  
Always disconnect tool from air to prevent unexpected operation during service.



**DO NOT EXCEED 120 PSI!**  
Personal injury could occur.



Figure 1. Model H6192 inventory.

## Assembly

To assemble the Model H6192:

1. Install a 1/4" NPT male quick-connect fitting (not included) into the air inlet.
2. Attach a 5" hook and loop sanding disc to the sanding pad as shown in **Figure 2**.



Figure 2. Attaching sanding disc.

## Product Information

- 10,000 RPM
- Requires 90 PSI
- Requires 5 CFM
- Requires 5" hook and loop sanding disc with 5-hole pattern
- 1/4" NPT air inlet
- Weighs 2.4 lbs.
- 1 1/4" Dust port
- Directional exhaust port

## Inventory

- A. Orbital Sander ..... 1  
B. Wrench ..... 1

- (Optional) Attach the sander to a 1 1/4" vacuum hose as shown in **Figure 3**.

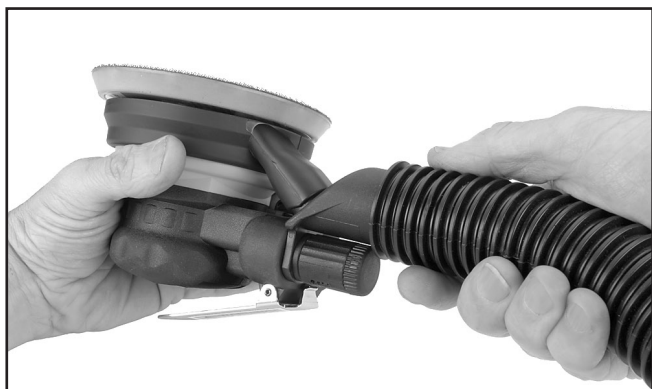
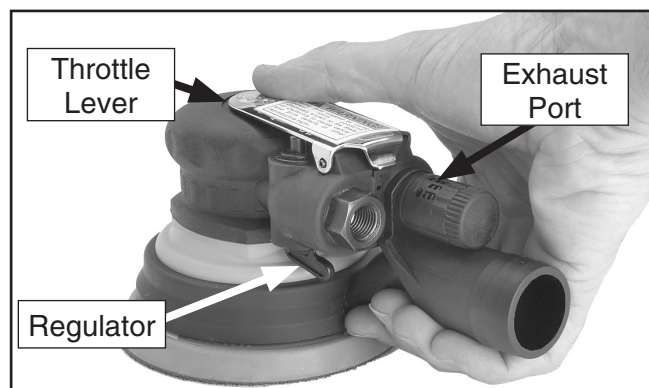

**Figure 3.** Attaching sander to 1 1/4" canister vacuum hose.

## Operation

### To operate the sander:

- Plug the tool into compressed air and turn **ON** the optional canister vacuum.
- Hold the sander and press the throttle lever (**Figure 4**) to turn the sander **ON**.



**Figure 4.** Sander controls.

- Turn the regulator (**Figure 4**) to adjust the sanding pad speed to a fixed rate, and rotate the directional exhaust port.
- Remove pressure on the throttle lever to stop the sanding pad, then turn the vacuum **OFF**.
- When the sandpaper loses its effectiveness, **disconnect the sander** and replace the sandpaper.

*If you need help with your new pneumatic tool, call our Tech Support at: (570) 546-9663.*

## Maintenance

Lubricate at the beginning of the sanding task. Place one or two drops of pneumatic tool oil directly into the air fitting as shown in **Figure 5**.

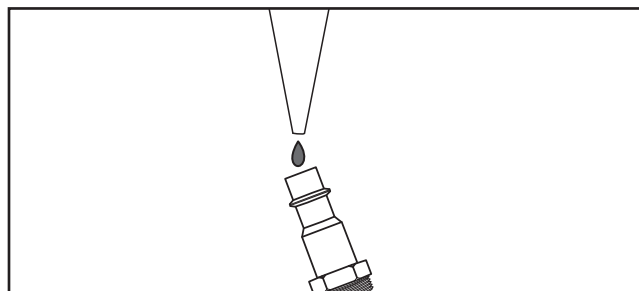

**Figure 5.** Lubricating directly into air fitting.

Considerable caution must be used with an inline lubricator set up, as excess oil will be expelled from the sander onto the workpiece. If you must use an inline lubricator, monitor the exhaust port for oil emissions to avoid spraying oil on your workpiece.

Before installing the sanding disc, run the sander for a few minutes to eject excess oil, then wipe the tool down with a clean rag and begin sanding. Oil the tool after use or storage.

## Service

### To replace the sanding pad:

- Insert the included wrench onto the spindle as shown in **Figure 6**.

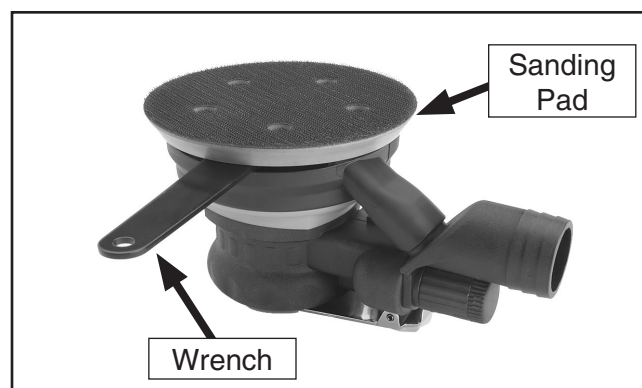

**Figure 6.** Wrench inserted onto spindle.

- Hold the wrench and unscrew the sanding pad.
- Install a new sanding pad (Part # PH6192039) and secure it with the wrench.

# Accessories

## H3263—5 Pc. Quick Coupler Set

This 5-Pc. Solid Brass Quick Coupler Set includes one 1/4" NPT female quick coupler, one 1/4" NPT female thread connector and three 1/4" NPT male thread connectors.

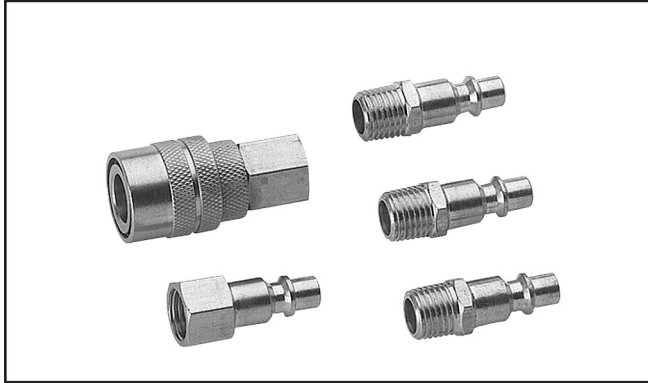

Figure 7. H3263 Quick Coupler Set.

## H3275—1/4" x 25' Coil Hose

These recoil hoses stay neatly coiled when not in use, yet stretch to full length when needed. Great for bench-top use when clutter is always a concern. Coil springs protect ends from kinking. 1/4"NPT.

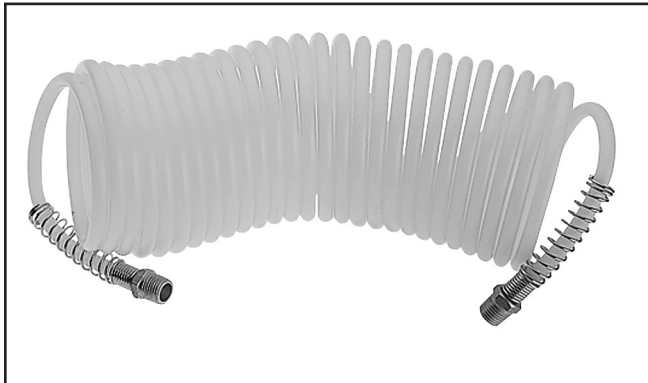

Figure 8. H3275 Coil Hose.

- G6407—60 Grit, 5" Sanding Disc
- G6408—80 Grit, 5" Sanding Disc
- G6409—100 Grit, 5" Sanding Disc
- G6410—120 Grit, 5" Sanding Disc
- G6411—150 Grit, 5" Sanding Disc
- G6412—220 Grit, 5" Sanding Disc
- H6604—280 Grit, 5" Sanding Disc
- H6605—320 Grit, 5" Sanding Disc
- H6606—400 Grit, 5" Sanding Disc
- H6607—500 Grit, 5" Sanding Disc
- H6608—600 Grit, 5" Sanding Disc

## H2499—Small Half-Mask Respirator

## H3631—Medium Half-Mask Respirator

## H3632—Large Half-Mask Respirator

## H3635—Disposable Cartridge Filter Pair P100

Wood dust is now considered a known carcinogen and has been linked to nasal cancer and severe respiratory illnesses. If you work around dust everyday, a half-mask respirator can be a lifesaver. Also compatible with safety glasses!



Figure 9. Half-mask respirator and disposable cartridge filters.

## G9955—Bench Top Dual Fan Dust Filter

Two separately switched fan motors can be used to draw a maximum 400 CFM of your dusty shop air through the 5 micron pleated filter. Perfect for sanding and power carving, the clear plastic hood helps to direct flow from the work area directly into the filter.



Figure 10. G9955 Dust Filter.

# H6192 Parts Breakdown and List

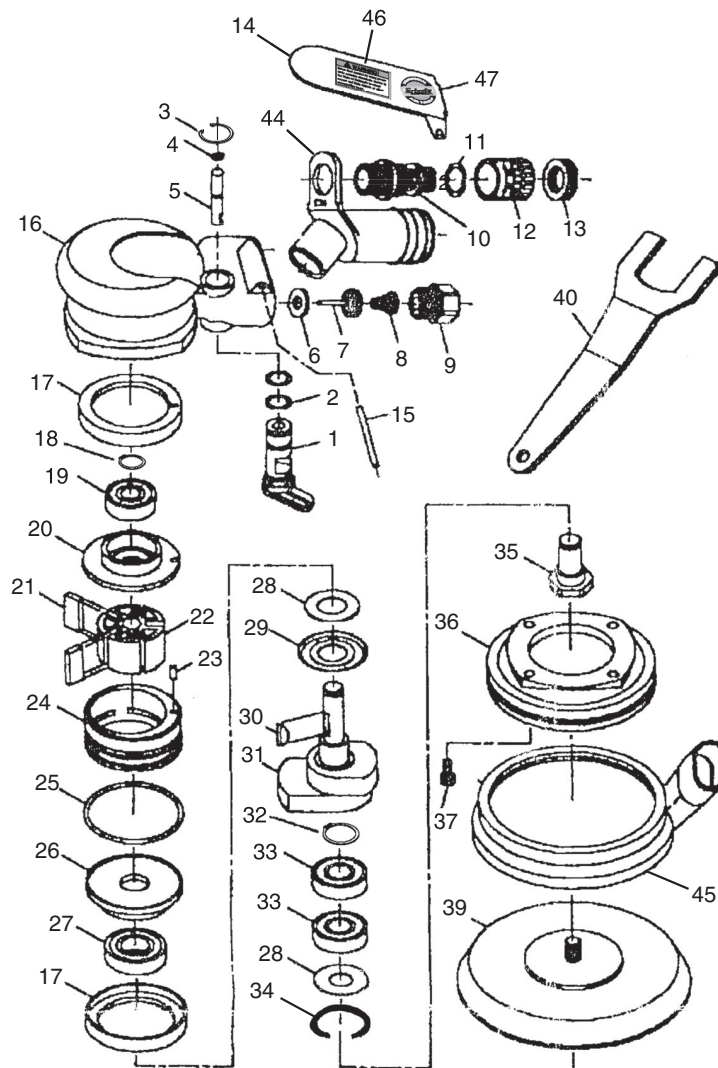

REF	PART #	DESCRIPTION
1	PH6192001	REGULATOR
2	PH6192002	O-RING
3	PR49M	INT RETAINING RING 12MM
4	PH6192004	O-RING
5	PH6192005	VALVE STEM
6	PH6192006	WASHER
7	PH6192007	NEEDLE VALVE
8	PH6192008	VALVE SPRING
9	PH6192009	INLET BUSHING
10	PH6192010	MUFFLER BODY
11	PH6192011	O-RING
12	PH6192012	EXHAUST SLEEVE
13	PH6192013	EXHAUST SLEEVE NUT
14	PH6192014	THROTTLE LEVER
15	PRP53M	ROLL PIN 3 X 40
16	PH6192016	HOUSING
17	PH6192017	GASKET
18	PR16M	EXT RETAINING RING 9MM
19	P6000	BALL BEARING 6000ZZ
20	PH6192020	REAR PLATE
21	PH6192021	ROTOR BLADE
22	PH6192022	ROTOR

REF	PART #	DESCRIPTION
23	PRP61M	ROLL PIN 3 X 12
24	PH6192024	CYLINDER
25	PH6192025	O-RING 47 X 2.5
26	PH6192026	FRONT PLATE
27	P6000	BALL BEARING 6000ZZ
28	PH6192028	SPECIAL WASHER
29	PH6192029	SPECIAL WASHER
30	PH6192030	WOODRUFF KEY
31	PH6192031	MOTOR SHAFT BALANCER
32	PR48M	EXT RETAINING RING 11MM
33	P6001	BALL BEARING 6001ZZ
34	PH6192034	SPECIAL EXT RETAINING RING
35	PH6192035	SHAFT
36	PH6192036	HOUSING COVER
37	PSB50M	CAP SCREW M5-.8 X 10
39	PH6192039	5" SANDING PAD
40	PH6192040	SPINDLE WRENCH
44	PH6192044	VACUUM PORT 1-1/4 " OD
45	PH6192045	SHROUD
46	PH6192046	DUST WARNING LABEL
47	PH6192047	GRIZZLY AIR TOOLS LABEL

## Free Manuals Download Website

<http://myh66.com>

<http://usermanuals.us>

<http://www.somanuals.com>

<http://www.4manuals.cc>

<http://www.manual-lib.com>

<http://www.404manual.com>

<http://www.luxmanual.com>

<http://aubethermostatmanual.com>

Golf course search by state

<http://golfingnear.com>

Email search by domain

<http://emailbydomain.com>

Auto manuals search

<http://auto.somanuals.com>

TV manuals search

<http://tv.somanuals.com>