

Grizzly **Industrial, Inc.**®

4" X 36" BELT & 6" DISC COMBO SANDER MODEL G0547 INSTRUCTION MANUAL



COPYRIGHT © NOVEMBER, 2003 BY GRIZZLY INDUSTRIAL, INC.
**WARNING: NO PORTION OF THIS MANUAL MAY BE REPRODUCED IN ANY SHAPE
OR FORM WITHOUT THE WRITTEN APPROVAL OF GRIZZLY INDUSTRIAL, INC.**

ONLINE MANUAL DISCLAIMER

THE INFORMATION IN THIS MANUAL REPRESENTS THE CONFIGURATION OF THE MACHINE AS IT IS CURRENTLY BEING SHIPPED. THE MACHINE CONFIGURATION CAN CHANGE AS PRODUCT IMPROVEMENTS ARE INCORPORATED. IF YOU OWN AN EARLIER VERSION OF THE MACHINE, THIS MANUAL MAY NOT EXACTLY DEPICT YOUR MACHINE. CONTACT CUSTOMER SERVICE IF YOU HAVE ANY QUESTIONS ABOUT DIFFERENCES.

PREVIOUS VERSIONS ARE NOT AVAILABLE ONLINE.

#5120 PRINTED IN CHINA

WARNING

Some dust created by power sanding, sawing, grinding, drilling, and other construction activities contains chemicals known to the State of California to cause cancer, birth defects or other reproductive harm. Some examples of these chemicals are:

- Lead from lead-based paints.
- Crystalline silica from bricks, cement, and other masonry products.
- Arsenic and chromium from chemically treated lumber.

Your risk from these exposures varies, depending on how often you do this type of work. To reduce your exposure to these chemicals: work in a well ventilated area, and work with approved safety equipment, such as those dust masks that are specially designed to filter out microscopic particles.

Table of Contents

SECTION 1: SAFETY	2
Safety Instructions for Power Tools	2
Additional Safety Instructions for the G0547 Combo Sander.....	4
SECTION 2: INTRODUCTION	5
SECTION 3: CIRCUIT REQUIREMENTS	6
110 Volt.....	6
Grounding	7
Extension Cords	7
SECTION 4: MACHINE FEATURES	8
SECTION 5: SET UP	9
Unpacking	9
Parts Inventory	9
Hardware Recognition Chart.....	10
Site Considerations.....	11
Beginning Assembly	12
Mounting Sander.....	12
Installing Disc Guard.....	12
Installing Disc Table	13
Squaring Table	13
Attaching Sandpaper	14
Aligning Table	15
Adjusting Miter Gauge	15
Adjusting Belt Angle	16
Installing Back Stop	16
Installing Sanding Belt	16
Adjusting Sanding Belt Tracking.....	17
Installing Dust Collection Hose.....	17
SECTION 6: OPERATIONS	18
General	18
Power Switch	18
Disc Sanding.....	19
Miter Sanding	19
Angle Sanding.....	20
Installing Table on Sanding Belt.....	20
Horizontal Sanding	21
Curved Sanding	21
SECTION 7: MAINTENANCE	22
Maintenance Safety	22
Schedule	22
Replacing Drive Belt	23
Lubricating Sleeve Bearings	23
SECTION 8: REFERENCE INFO	24
General	24
Aftermarket Accessories	24
Machine Data Sheet	25
Parts Breakdown.....	26
Parts List.....	27
Troubleshooting Guide	28
Maintenance Notes	29
Warranty and Returns.....	30

SECTION 1: SAFETY

WARNING

For Your Own Safety Read Instruction Manual Before Operating This Equipment

The purpose of safety symbols is to attract your attention to possible hazardous conditions. This manual uses a series of symbols and signal words which are intended to convey the level of importance of the safety messages. The progression of symbols is described below. Remember that safety messages by themselves do not eliminate danger and are not a substitute for proper accident prevention measures.



Indicates an imminently hazardous situation which, if not avoided, WILL result in death or serious injury.



Indicates a potentially hazardous situation which, if not avoided, COULD result in death or serious injury.



Indicates a potentially hazardous situation which, if not avoided, MAY result in minor or moderate injury. It may also be used to alert against unsafe practices.

NOTICE

This symbol is used to alert the user to useful information about proper operation of the equipment.

WARNING

Safety Instructions for Power Tools

1. **KEEP GUARDS IN PLACE** and in working order.
2. **REMOVE ADJUSTING KEYS AND WRENCHES.** Form a habit of checking to see that keys and adjusting wrenches are removed from tool before turning on.
3. **KEEP WORK AREA CLEAN.** Cluttered areas and benches invite accidents.
4. **NEVER USE IN DANGEROUS ENVIRONMENT.** DO NOT use power tools in damp or wet locations, or where any flammable or noxious fumes may exist. Keep work area well lighted.
5. **KEEP CHILDREN AND VISITORS AWAY.** All children and visitors should be kept at a safe distance from work area.
6. **MAKE WORKSHOP CHILD PROOF** with padlocks, master switches, or by removing starter keys.
7. **NEVER FORCE TOOL.** It will do the job better and safer at the rate for which it was designed.
8. **USE RIGHT TOOL.** DO NOT force tool or attachment to do a job for which it was not designed.

WARNING

Safety Instructions for Power Tools

- 9. USE PROPER EXTENSION CORD.** Make sure your extension cord is in good condition. Conductor size should be in accordance with the chart below. The amperage rating should be listed on the motor or tool nameplate. An undersized cord will cause a drop in line voltage resulting in loss of power and overheating. Your extension cord must also contain a ground wire and plug pin. Always repair or replace extension cords if they become damaged.

Minimum Gauge for Extension Cords

AMP RATING	LENGTH		
	25ft	50ft	100ft
0-6	16	16	16
7-10	16	16	14
11-12	16	16	14
13-16	14	12	12
17-20	12	12	10
21-30	10	10	No

- 10. WEAR PROPER APPAREL.** DO NOT wear loose clothing, gloves, neckties, rings, bracelets, or other jewelry which may get caught in moving parts. Non-slip footwear is recommended. Wear protective hair covering to contain long hair.
- 11. ALWAYS USE SAFETY GLASSES.** Also use face or dust mask if cutting operation is dusty. Everyday eyeglasses only have impact resistant lenses, they are NOT safety glasses.
- 12. ALLERGIES:** Certain wood may cause an allergic reaction in people or animals, especially when exposed to fine dust. Make sure you know what type of wood dust you will be exposed to and wear proper respirators.
- 13. DO NOT OVER-REACH.** Keep proper footing and balance at all times.
- 14. MAINTAIN TOOLS WITH CARE.** Keep tools sharp and clean for best and safest performance. Follow instructions for lubricating and changing accessories.

- 15. USE RECOMMENDED ACCESSORIES.** Consult the owner's manual for recommended accessories. The use of improper accessories may cause risk of injury.
- 16. REDUCE THE RISK OF UNINTENTIONAL STARTING.** On machines with magnetic contact starting switches there is a risk of starting if the machine is bumped or jarred. Always disconnect from power source before adjusting or servicing. Make sure switch is in OFF position before reconnecting.
- 17. CHECK DAMAGED PARTS.** Before further use of the tool, a guard or other part that is damaged should be carefully checked to determine that it will operate properly and perform its intended function. Check for alignment of moving parts, binding of moving parts, breakage of parts, mounting, and any other conditions that may affect its operation. A guard or other part that is damaged should be properly repaired or replaced.
- 18. NEVER LEAVE TOOL RUNNING UNATTENDED. TURN POWER OFF.** DO NOT leave tool until it comes to a complete stop.
- 19. NEVER OPERATE A MACHINE WHEN TIRED, OR UNDER THE INFLUENCE OF DRUGS OR ALCOHOL.** Full mental alertness is required at all times when running a machine.
- 20. NEVER ALLOW UNSUPERVISED OR UNTRAINED PERSONNEL TO OPERATE THE MACHINE.** Make sure any instructions you give in regards to machine operation are approved, correct, safe, and clearly understood.
- 21. IF AT ANY TIME YOU ARE EXPERIENCING DIFFICULTIES** performing the intended operation, stop using the machine! Then contact our service department or ask a qualified expert how the operation should be performed.

⚠️ WARNING

Additional Safety Instructions for the G0547 Combo Sander

- **READ THIS MANUAL.** This manual contains proper operating instructions for this machine.
- **DO NOT** jam the workpiece against the sanding surfaces. Firmly grasp the workpiece in both hands and ease it against the belt/disc using light pressure.
- **DO NOT** wear loose clothing while operating this machine. Roll up or button sleeves at the cuff.
- **DO NOT** place hands near, or in contact with, sanding surfaces during operation.
- **GRIP THE WORKPIECE WITH BOTH HANDS.**
- **PERFORM** machine inspections and maintenance promptly when needed.
- **NEVER** leave the machine running unattended.
- **REPLACE** sanding discs and belts when they become worn.
- **NEVER** sand more than one piece of stock at a time.
- **ALWAYS** inspect board stock for nails, staples, knots, and other imperfections that could be dislodged and thrown from the machine during sanding operations.
- **NEVER** operate the sander without an adequate dust collection system in place and running.
- **NEVER** sand tapered or pointed stock with the point facing the feed direction.
- **DISCONNECT THE MACHINE FROM THE POWER SOURCE** before changing the sanding disc or belt.
- **TEST RUN THE MACHINE** before starting any work.

⚠️ CAUTION

No list of safety guidelines can be complete. Every shop environment is different. Always consider safety first, as it applies to your individual working conditions. Use this and other machinery with caution and respect. Failure to follow guidelines could result in serious personal injury, damage to equipment or poor work results.

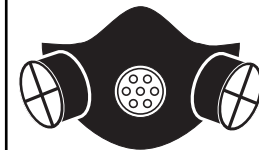

⚠️ CAUTION

Always wear a respirator when operating the Model G0547. Using this machine produces sawdust which may cause allergic reactions or respiratory problems.

SECTION 2: INTRODUCTION

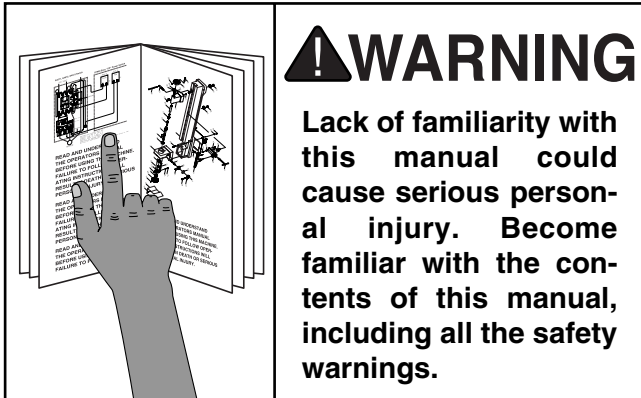

WARNING

Lack of familiarity with this manual could cause serious personal injury. Become familiar with the contents of this manual, including all the safety warnings.

We are proud to offer the Model G0547 4" x 36" Belt & 6" Disc Combo Sander. This machine is part of a growing Grizzly family of fine woodworking machinery. When used according to the guidelines set forth in this manual, you can expect years of trouble-free, enjoyable operation and proof of Grizzly's commitment to customer satisfaction.

We are pleased to provide this manual with the Model G0547. It was written to guide you through assembly, review safety considerations, and cover general operating procedures. It represents our effort to produce the best documentation possible.

If you have any comments regarding this manual, please write to us at the address below:

Grizzly Industrial, Inc.
c/o Technical Documentation
P.O. Box 2069
Bellingham, WA 98227-2069

Most importantly, we stand behind our machines. If you have any service questions or parts requests, please call or write us at the location listed below.

Grizzly Industrial, Inc.
1203 Lycoming Mall Circle
Muncy, PA 17756
Phone: (570) 546-9663
Fax: (800) 438-5901
E-Mail: techsupport@grizzly.com
Web Site: <http://www.grizzly.com>

The specifications, drawings, and photographs illustrated in this manual represent the Model G0547 as supplied when the manual was prepared. However, owing to Grizzly's policy of continuous improvement, changes may be made at any time with no obligation on the part of Grizzly. For your convenience, we always keep current Grizzly manuals available on our website at www.grizzly.com. Any updates to your machine will be reflected in these manuals as soon as they are complete. Visit our site often to check for the latest updates to this manual!



SECTION 3: CIRCUIT REQUIREMENTS

110 Volt

Amperage Draw

The Model G0547 1/3 HP motor is wired to operate at 110V and will draw the following load:

Motor Load5 Amps

Plug Type

The Model G0547 is supplied with a NEMA 5-15 plug. DO NOT modify the plug or power cord in any way. See **Figure 1** for a NEMA 5-15 plug and grounded outlet.

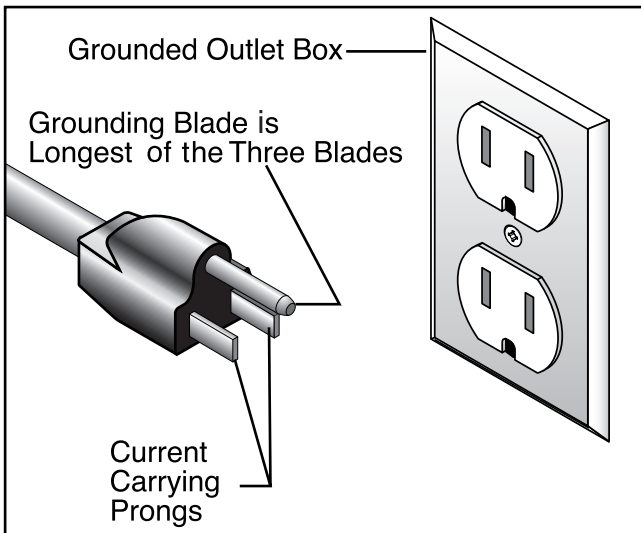

Figure 1. NEMA 5-15 plug and grounded outlet.

Circuit Breaker Requirements

We recommend that the circuit you use your machine on should be dedicated. Use the following guidelines when choosing a circuit breaker for your machine (circuit breakers rated any higher are not adequate to protect the circuit):

Recommended Circuit Breaker10 Amp

Your Circuit Capacity

Always check to see if the wires in your circuit are capable of handling the amperage load from your machine. If you are unsure, consult a qualified electrician.

If you operate this machine on any circuit that is already close to its capacity, it might blow a fuse or trip a circuit breaker. However, if you are not placing an unusual load on the machine and a power failure still occurs, contact a qualified electrician or our Service Department at (570) 546-9663.

!WARNING

Serious personal injury could occur if you connect your machine to the power source before you have completed the assembly process. DO NOT connect the machine to the power source until instructed to do so.



Grounding

In the event of an electrical short, grounding reduces the risk of electric shock by providing a path of least resistance to disperse electric current. This tool is equipped with a power cord that has an equipment-grounding prong. The outlet must be properly installed and grounded in accordance with all local codes and ordinances.

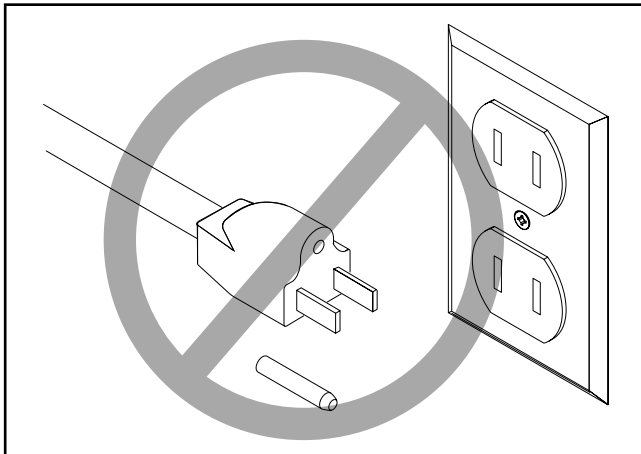
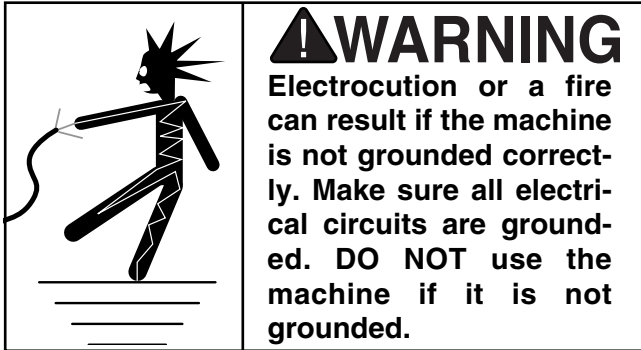

⚠ CAUTION

This machine must have a ground prong in the plug to help ensure that it is grounded. **DO NOT** remove ground prong from plug to fit into a two-pronged outlet! If the plug will not fit the outlet, have the proper outlet installed by a qualified electrician.

NOTICE

The wire on the power cord with green or green and yellow striped insulation is the grounding conductor.



Extension Cords

110V Operation

If you find it necessary to use an extension cord at 110V:

- Make sure the cord is rated Standard Service (grade S) or better.
- The extension cord must also contain a ground wire and plug pin.
- Use at least a 16 gauge cord.
- **DO NOT** use a cord longer than 100 feet!

⚠ CAUTION

No single list of electrical guidelines can be comprehensive for all shop environments. Operating this machinery may require additional electrical upgrades specific to your machine and shop environment. It is your responsibility to make sure your electrical systems comply with all local electrical codes and ordinances.



SECTION 4: MACHINE FEATURES

An important part of safety is knowing your machine and its components. Take the time to familiarize yourself with the features of your new Model G0547 Combo Sander. They will be frequently mentioned throughout the instructions in this manual.

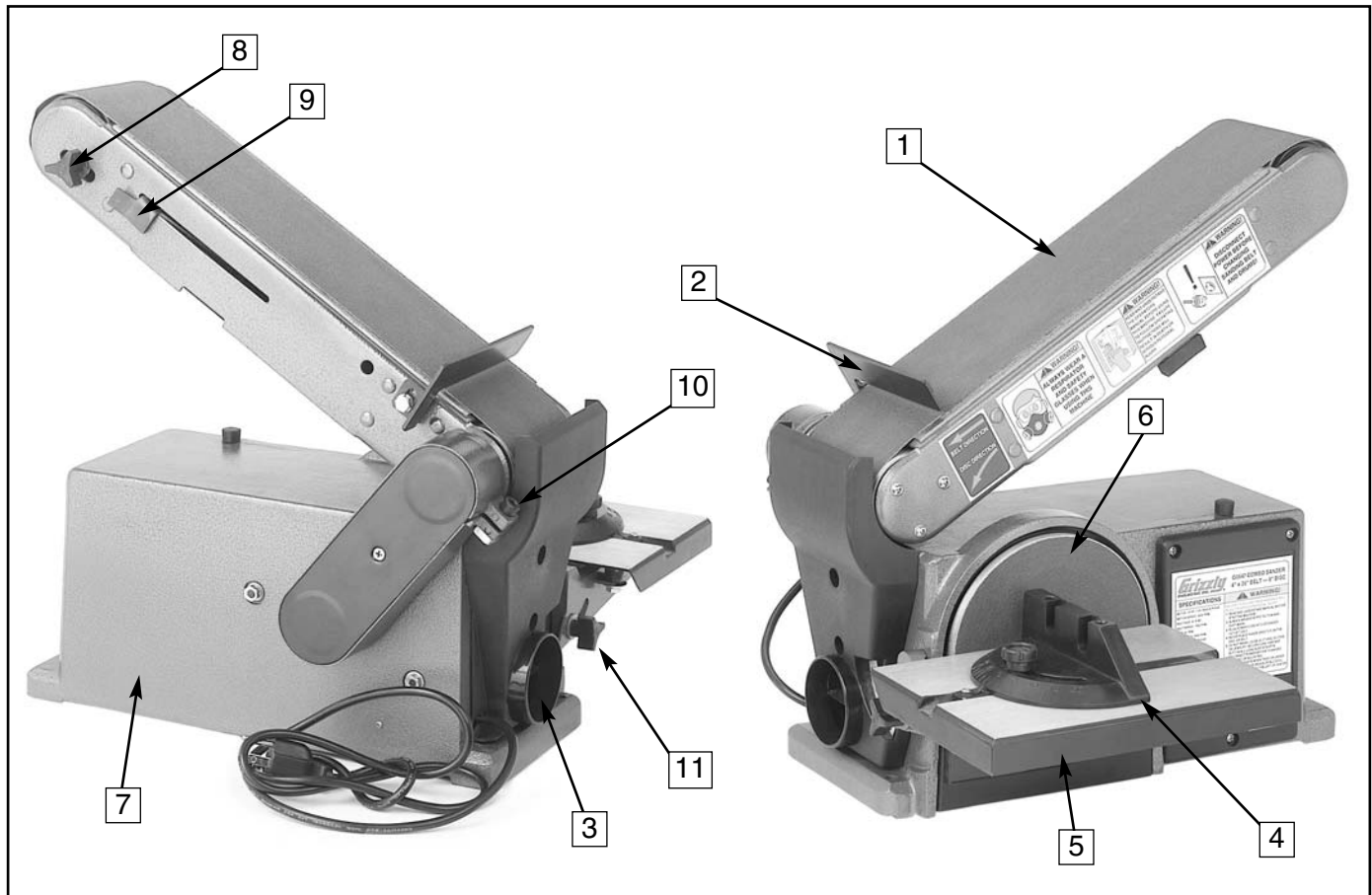

Figure 2. Machine Features.

1. Sanding Belt
2. Back Stop
3. Dust Port
4. Miter Gauge
5. Disc Sanding Table
6. Sanding Disc
7. Sander Base
8. Tracking Knob
9. Belt Tensioning Lever
10. Bed Angle Release Screw
11. Table Angle Knob

SECTION 5: SET UP

Unpacking

The machine was carefully packed when it left the Grizzly warehouse. If you discover the machine is damaged after you have signed for delivery, and the truck and driver are gone, you will need to file a freight claim with the carrier. Save the containers and all packing materials for possible inspection by the carrier or its agent. Without the packing materials, filing a freight claim can be difficult. If you need assistance determining whether you need to file a freight claim, or with the procedure to file one, please contact our Customer Service.

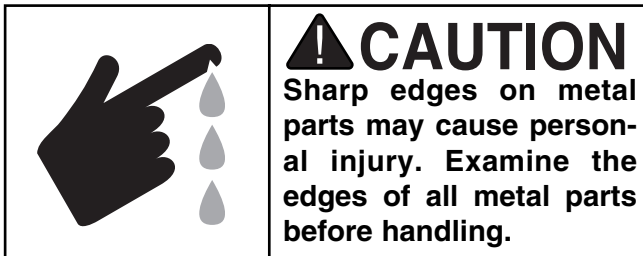

When you are completely satisfied with the condition of your shipment, you should inventory its parts.



Parts Inventory

DESCRIPTION	Qty
A. Sander Unit (Not Shown)	1
B. Disc Sanding Table	1
C. Sanding Disc	1
D. Sanding Belt (Not Shown)	1
E. Table Support	1
F. Disc Guard	1
G. Back Stop	1
H. Miter Gauge	1
I. Hardware Bag	
• Switch Key	1
• Knob	1
• Washer 6mm	5
• Lock Washer 6mm	4
• Hex Head Bolt M6-1.0 x 14	4
• Self Tapping Screw M4 x 8	2

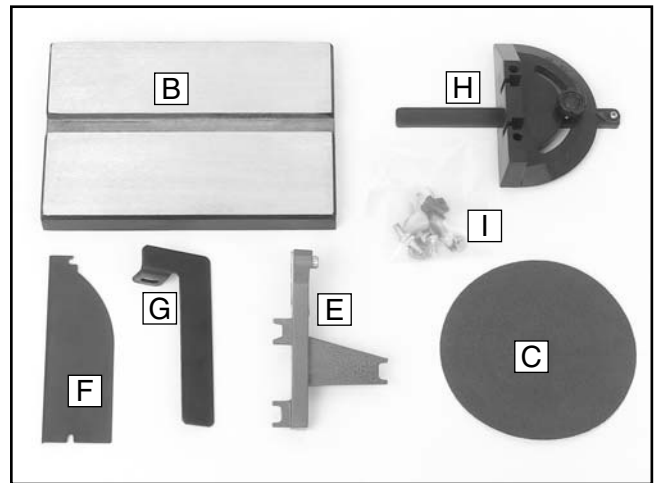







Figure 3. G0547 inventory.



Hardware Recognition Chart

USE THIS CHART TO MATCH UP HARDWARE DURING THE ASSEMBLY PROCESS!

MEASURE BOLT DIAMETER BY PLACING INSIDE CIRCLE

-  #10
-  1/4"
-  5/16"
-  3/8"
-  7/16"
-  1/2"

-  5/8"

-  4mm

-  6mm

-  8mm

-  10mm

-  12mm

-  16mm

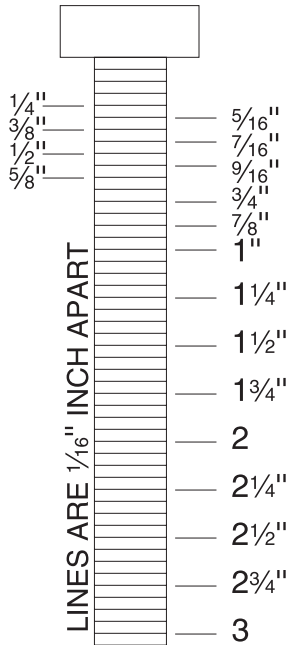
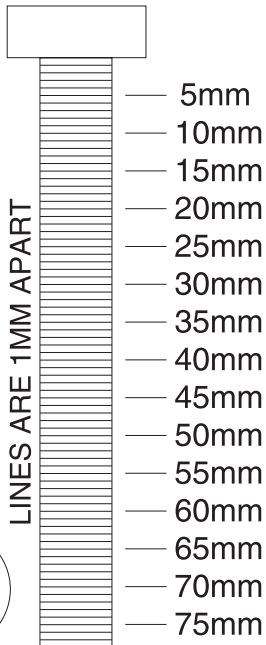
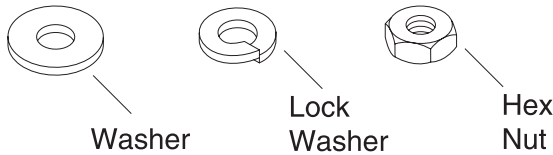
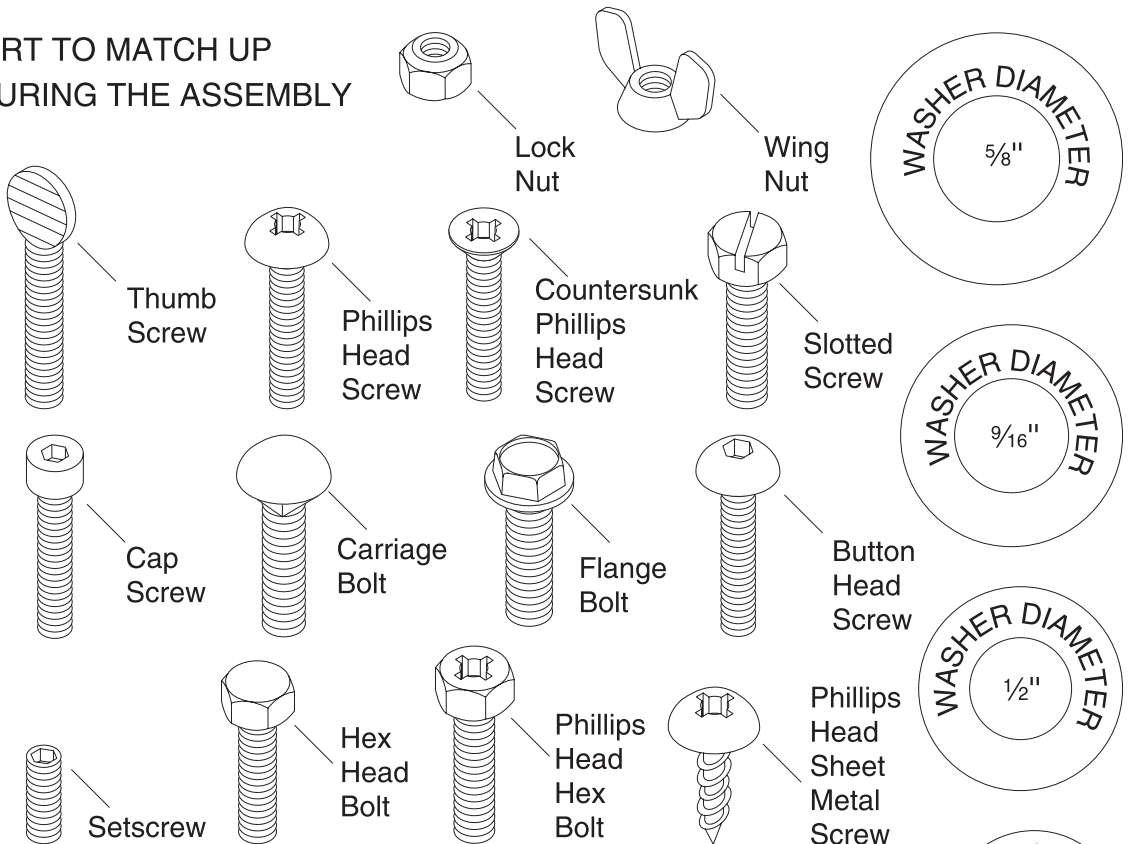

WASHERS ARE MEASURED BY THE INSIDE DIAMETER

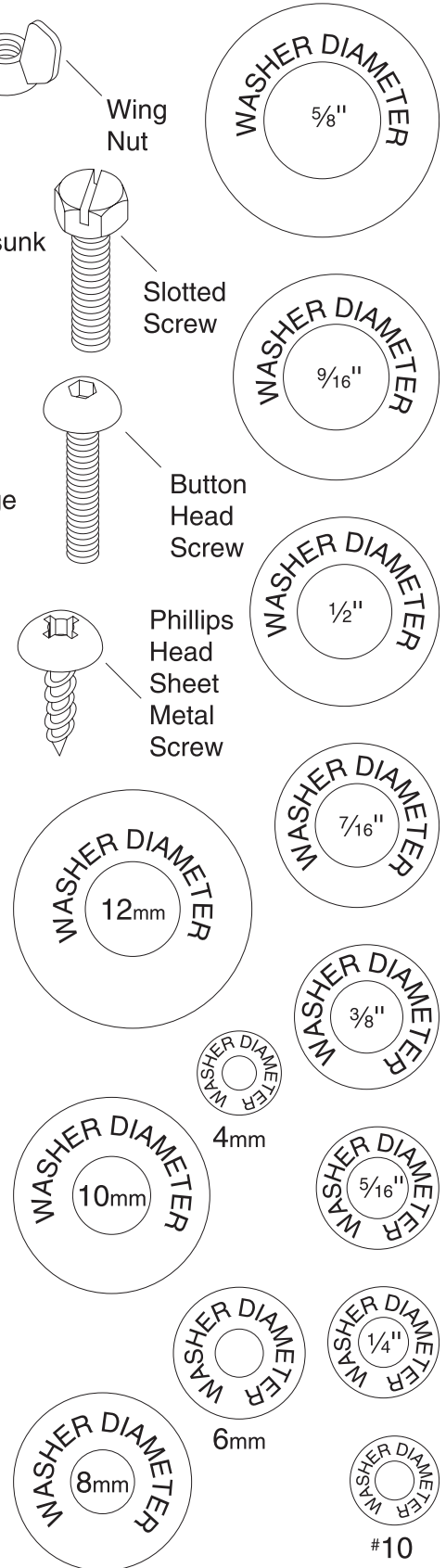

Site Considerations

Weight Load

The Model G0547 Combo Sander is a small weight load with a small footprint. Most tables and workbenches should be sufficient to carry the weight of the machine. Reinforce the table or workbench if you question its ability to support the added weight.

Working Clearance

Working clearances can be thought of as the distances between machines and obstacles that allow safe operation of every machine without limitation. Consider existing and anticipated machine needs, size of material to be processed through each machine, and space for auxiliary stands or work tables. Also consider the relative position of each machine to one another for efficient material handling.

Lighting and Outlets Lighting should be bright enough to eliminate shadow and prevent eye strain. Electrical circuits should be dedicated or large enough to handle the amperage draw. Outlets should be located near each machine so power or extension cords are clear of high-traffic areas. Observe local electrical codes for proper installation of new lighting, outlets, or circuits.

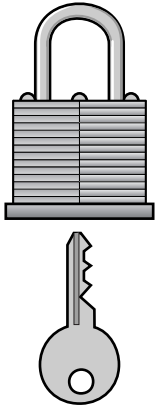
	<p>!WARNING</p> <p>Unsupervised children and visitors inside your shop could receive serious personal injury. Ensure child and visitor safety by keeping all entrances to the shop locked at all times. DO NOT allow unsupervised children or visitors in the shop at any time.</p>
--	---





Beginning Assembly

This section will cover the basic assembly and adjustment instructions needed to begin operation. Complete the assembly in the order provided in this manual and then read the remaining portion of the manual before attempting any type of operation.

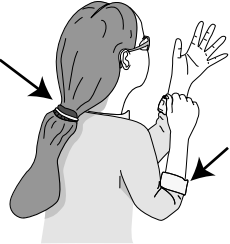
Your safety is important! Please follow the warnings below during this entire section:

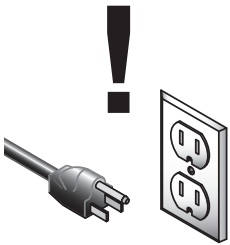
	<p>⚠ WARNING</p> <p>Loose hair and clothing could get caught in machinery and cause serious personal injury. Keep loose clothing rolled up and long hair tied up and away from machinery.</p>
---	--

	<p>⚠ WARNING</p> <p>Serious personal injury could occur if you connect your machine to the power source before you have completed the assembly process. DO NOT connect the machine to the power source until instructed to do so.</p>
---	---

	<p>⚠ CAUTION</p> <p>Sharp edges on metal parts may cause personal injury. Examine the edges of all metal parts before handling.</p>
---	--



Mounting Sander

To mount the sander to a workbench:

1. Screw $\frac{1}{4}$ " x $1\frac{1}{2}$ " (or longer) lag bolts with $\frac{1}{4}$ " washers through the holes in the base and into the workbench.

To attach the sander to a mounting board:

1. Mount the base of the sander to the center of a piece of $\frac{3}{4}$ " plywood that is at least 18"W x 24"D.
2. Clamp the plywood securely to a workbench.



Installing Disc Guard

To install the disc guard:

1. Align the disc guard with the holes on the lower half of the disc.
2. Use the M4 x 8 self tapping screws to attach the disc guard to the sander base as shown in **Figure 4**.



Figure 4. Attaching the disc guard.



Installing Disc Table

To install the disc table:

1. Lay the table upside down and align the table support with the holes in the table.
2. Take three hex bolts out of the hardware bag and put a lock washer and a flat washer on each bolt.
3. Screw the hex bolts with washers through the table support and into the disc table as shown in **Figure 5**.

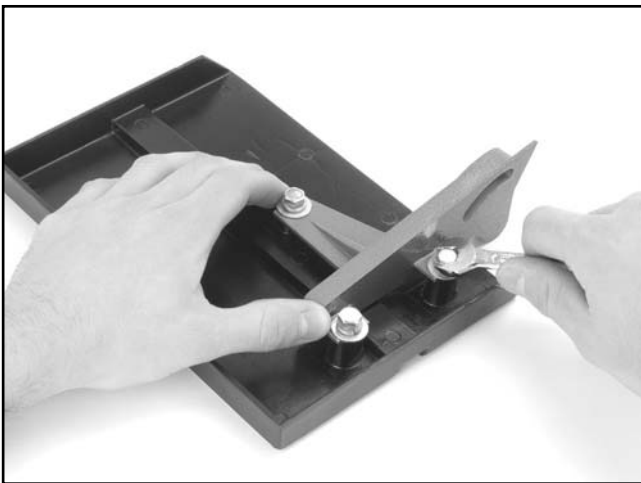

Figure 5. Bolting the table support to the disc table.

4. Insert the index pin shown in **Figure 6** into the upper hole on the base and tighten the knob.

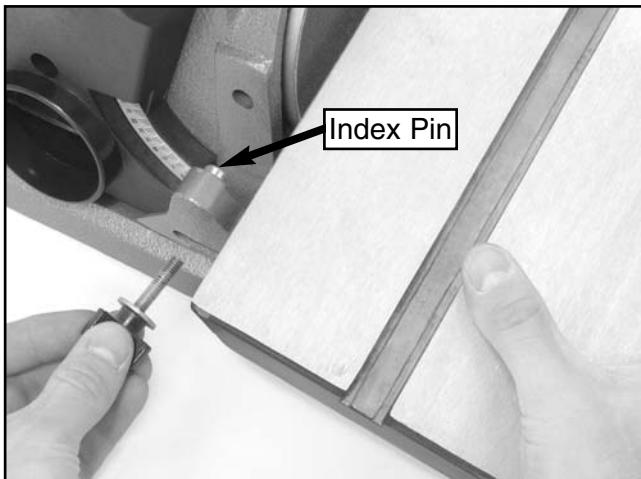

Figure 6. Inserting the index pin into the base.



Squaring Table

When the table tilt is set to 0°, the table should be adjusted perpendicular to the sanding disc face.

To square the table:

1. **Disconnect the machine from the power source!**
2. Using a try square or machinist's square, set one edge on the table surface and the other against the face of the disc as shown in **Figure 7**.

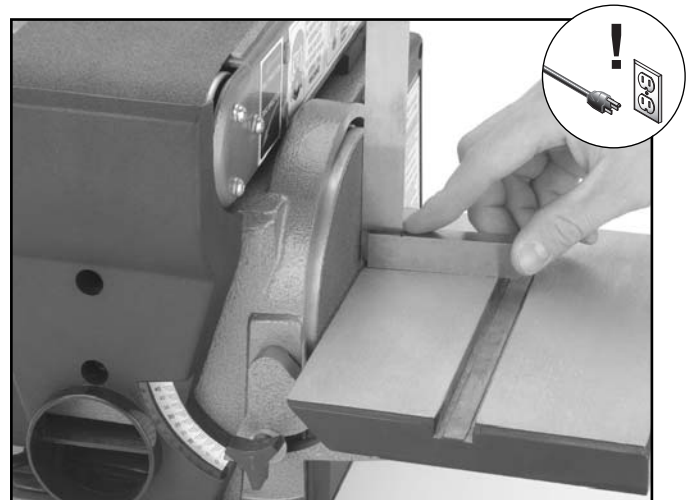

Figure 7. Squaring disc table.

3. Loosen the lock knob and adjust the table angle until there is no gap between the disc face and the square.
4. Tighten the lock knob while holding the table perpendicular.
5. Place the angle measurement label on the base so the angle indicator points to 0°.



Attaching Sandpaper

The Model G0547 Combo Sander accepts 6" diameter cloth or paper-backed pressure sensitive adhesive (PSA) sanding discs. These are available in a variety of grits. See the current Grizzly catalog for prices and ordering information.

The PSA sanding disc sticks directly to the surface of the aluminum disc and can be replaced without removing either the table or the dust port.

To attach sandpaper:

1. **Disconnect the machine from the power source!**
2. Remove the disc table and the lower guard.
3. Remove the worn out sandpaper.

Note—Make sure that all dust, grit, and adhesive from the old sandpaper is cleaned off the aluminum disc. This will ensure a good bond between the sandpaper and the disc.

4. Peel back the protective layer on one-half of the sandpaper disc and fold it against the remaining half.

5. Center the sticky half of the sandpaper on the upper half of the disc and press the sandpaper onto the surface (**Figure 8**).



Figure 8. Center the sandpaper on the disc.

6. Remove the remaining half of the protective layer and then press this portion against the disc.
7. Rotate the disc by hand and check to make sure the sandpaper is firmly attached to the disc. *Note—DO NOT turn the disc sander on at this point.*



Aligning Table

The table must be aligned to the face of the sanding disc so that the sandpaper does not rub against the table.

To align the table:

1. **Disconnect the machine from the power source!**
2. Loosen the hex bolts that secure the table to the table support bracket.
3. Adjust the table so that there is $\frac{3}{64}$ " or 1 mm between the table and the sanding disc as shown in **Figure 9**.

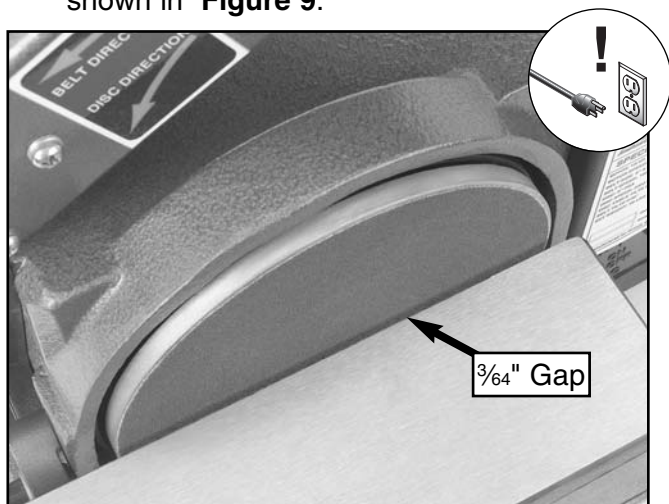

Figure 9. The gap between the table and the disc

4. Tighten the screws loosened in **step 1**.
5. Spin the disc by hand to check if the sandpaper is touching the table. *Note—DO NOT turn the disc sander on at this point.*
6. Repeat **steps 1-4** if the sandpaper touches the table at any point in the rotation.



Adjusting Miter Gauge

The miter gauge needs to be adjusted perpendicular to the face of the wheel when it is mounted in the table slot.

To adjust miter gauge:

1. **Disconnect the machine from the power source!**
2. Use a machinist square with one edge against the face of the miter gauge and the other against the disc face as shown in **Figure 10**.

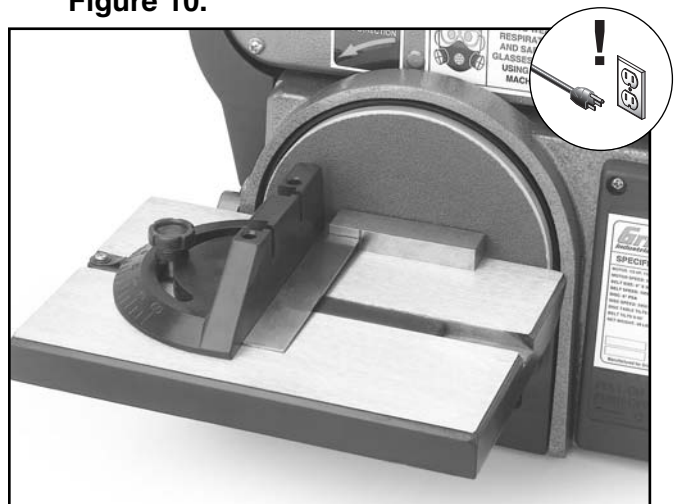

Figure 10. Squaring the miter gauge.

3. Loosen the lock knob on the miter gauge to adjust it flush with the edge of the square.
4. Tighten the lock knob, and verify the setting. *Note—Sometimes the tightening procedure can affect the adjustment.*
5. Loosen the setscrew that secures the angle pointer and adjust the pointer to the 0° mark on the scale.
6. Retighten the setscrew that secures the angle pointer.



Adjusting Belt Angle

To adjust the sanding belt angle:

1. Disconnect the machine from the power source!
2. Loosen the cap screw shown in **Figure 11**.



Figure 11. Raising the sanding belt bed.

3. Raise the sanding belt to the desired angle and tighten the cap screw.



Installing Back Stop

To install the back stop:

1. Screw a hex bolt, with a flat washer and a lock washer on it, through the back stop and into the hole shown in **Figure 12**.
2. Square the back stop as shown in **Figure 12** and tighten the hex bolt.

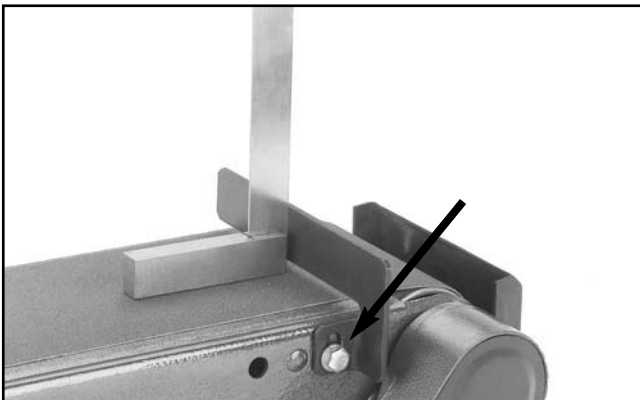

Figure 12. Squaring the back stop



Installing Sanding Belt

To install the sanding belt:

1. Disconnect the machine from the power source!
2. Loosen the belt tension by pulling out the tensioning lever shown in **Figure 13**.

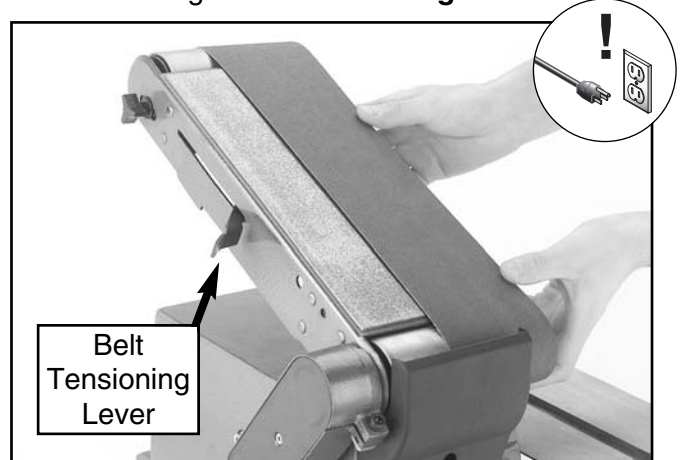

Figure 13. Installing belt.

3. Slide the belt onto the drive drums as shown in **Figure 13** and release the belt tensioning lever.

Note—make sure that the arrow on the inside of the sanding belt points the same direction as the belt rotation arrow on the machine.



Adjusting Sanding Belt Tracking

⚠️ WARNING

Before starting the sander, make sure you have performed the preceding assembly and adjustment instructions, and you have read through the rest of the manual and are familiar with the various functions and safety issues associated with this machine. Failure to follow this warning could result in serious personal injury.

Once the sanding belt is installed, test the belt tracking to see if the belt slides off the drum.

To test the tracking:

1. Remove all tools from the sander.
2. Plug the sander into the power source. Flip the switch *ON* and immediately turn the sander *OFF*.
3. If the sanding belt moves toward the disc, turn the tracking knob shown in **Figure 14** clockwise $\frac{1}{4}$ turn.

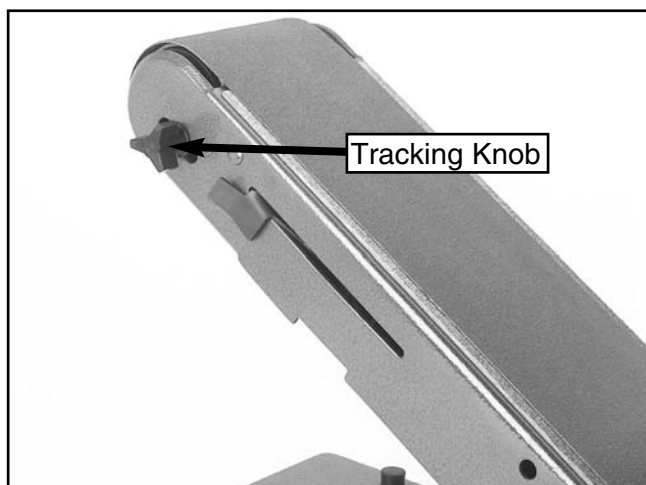

Figure 14. Sanding belt tracking knob.

4. If the sanding belt moves away from the disc, turn the tracking knob counterclockwise $\frac{1}{4}$ turn.

5. Flip the switch *ON* and immediately turn the sander *OFF*. The belt is tracking properly if it stays centered on the drive drums. If the belt moves to the side, return to **step 3**.

Note—Listen for any unusual noises, vibrations or rubbing while adjusting the tracking. If anything sounds unusual, stop the sander immediately. Disconnect the machine from the power source and find the source of the problem before operating further. If you cannot locate the source of an unusual noise or vibration, feel free to contact our service department for help.



Installing Dust Collection Hose

The dust collection for the sanding disc and the belt are fed into the same port that is located on the end of the sander as shown in **Figure 15**.

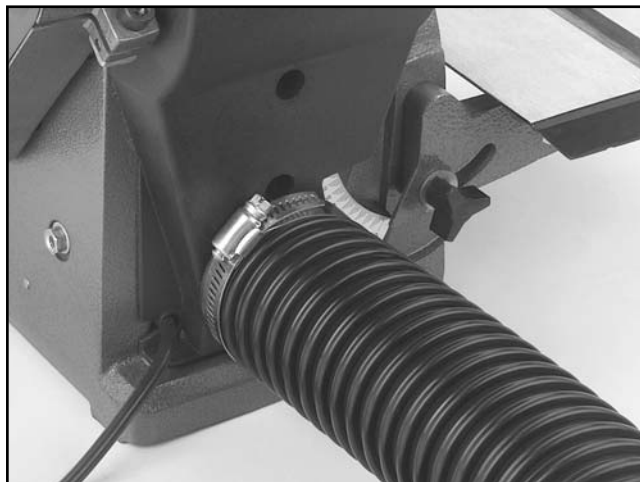

Figure 15. Hose connected to dust port.

To connect your machine to a dust collection system:

1. Place a 2½" diameter hose over the dust port.
2. Secure the hose in place with a hose clamp.



SECTION 6: OPERATIONS

General

This section covers basic sanding operations. Please read the remaining portion of the manual before attempting any type of operation.

Your safety is important! Please follow the warnings below during this entire section:

⚠️ WARNING

Damage to your eyes, lungs, and ears could result from failure to wear safety glasses, a respirator, and hearing protection while sanding with this machine.

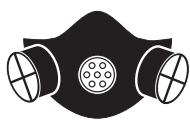

⚠️ WARNING

Loose hair and clothing could get caught in machinery and cause serious personal injury. Keep loose clothing rolled up and long hair tied up and away from machinery.

⚠️ WARNING

Operating this equipment has the potential to propel debris into the air which can cause eye injury. Always wear safety glasses or goggles when operating equipment. Everyday glasses or reading glasses only have impact resistant lenses, they are not safety glasses. Be certain the safety glasses you wear meet the appropriate standards of the American National Standards Institute (ANSI).

Power Switch

The Model G0547 Combo Sander is equipped with a paddle-type power switch with a safety key.

⚠️ WARNING

Make sure the power switch is in the **OFF** position before connecting the sander to the power source. Serious personal injury could occur if you connect your machine to the power source with the power switch on.

To operate the power switch:

1. Plug in the sander and insert the safety locking key shown in **Figure 16**.



Figure 16. Inserting the safety key.

2. Lift the switch to start and press the switch down to stop the motor.
3. Remove the locking key when the machine is not in use and store the key in a safe place.



Disc Sanding

⚠ CAUTION

Always keep the workpiece on the side of the wheel that is rotating down toward the table. This will keep the workpiece from flying out of your hands from the rotational forces.

To perform disc sanding operations:

1. Set the angle of the table relative to the sanding disc. The angle can be set with the angle scale on the disc sander or with a protractor for greater accuracy.
2. When a 90° horizontal angle is required, place one surface of the workpiece firmly against the face of the miter gauge (set at 0°), with the other surface against the face of the disc (**Figure 17**).



Figure 17. Disc sanding.

3. Use light pressure and move the workpiece slowly back and forth across the disc to prevent the workpiece from burning and to prevent excessive loading of the sanding disc.

Note—For sanding curves or irregular shapes, remove the miter gauge from the disc table.



Miter Sanding

The most efficient way to get a perfect miter is to cut the workpiece slightly long and sand it to the desired dimension. Miter sanding can be done easily with the miter gauge:

To perform miter sanding operations:

1. Loosen the knob on the miter gauge, adjust the angle to the desired point, and tighten the knob.
2. Slide the miter gauge into its slot and use it to hold your workpiece in position. Note—*The miter gauge can be used in either direction in the slot to achieve the proper relation of the workpiece to the disc.*
3. Use light pressure and move the workpiece slowly back and forth across the disc as shown in **Figure 18**.



Figure 18. Disc sanding with a miter gauge.

⚠ WARNING

Never use the Model G0547 for applications other than those for which it was made. DO NOT overload the machine or use excess force when sanding. Severe personal injury, damage to the machine, or damage to your workpiece could occur.



Angle Sanding

Miters can also be sanded by changing the angle of the table.

CAUTION

Always keep the workpiece on the side of the wheel that is rotating down toward the table. This will keep the workpiece from flying out of your hands from the rotational forces.

To perform angle sanding operations:

1. Loosen the knob securing the table.
2. Use the angle gauge to achieve the desired table angle and tighten the handles. Note—*The disc table can be positioned from 0° to 45°, relative to the plane of the sanding surface.*
3. Slide the miter gauge into the miter slot and use the miter gauge to hold your workpiece in position.
4. With light, but firm pressure, push the workpiece slowly into the downspin side of the rotating disc (**Figure 19**).



Figure 19. Mitering with the table angled.

5. Move the workpiece slowly back and forth across the downspin side of the disc.



Installing Table on Sanding Belt

The disc sanding table can be removed and installed on the sanding belt bed when the sanding belt bed is vertical. This gives the operator more working room when using the sanding belt.

To install the table on the sanding belt bed:

1. **Disconnect the machine from the power source!**
2. Raise the belt bed to vertical and remove the back stop.
3. Remove the disc sanding table.
4. Place the index pin of the disc sanding table in the upper hole in the sanding belt table.
5. Rotate the sanding table perpendicular to the sanding belt and screw in the knob as shown in **Figure 20**.



Figure 20. Installing the table for belt sanding.



Horizontal Sanding

Horizontal sanding allows you to sand the flat surface of a board.

To perform horizontal sanding operations:

1. Turn the power *ON* and allow the sander to reach full speed.
2. Place the workpiece against the surface of the sanding belt. Hold the workpiece firmly with both hands but keep fingers away from the sanding surface as shown in **Figure 21**.



Figure 21. Horizontal sanding.

3. Move the workpiece across the surface of the belt for even belt wear.
4. Use the back stop to prevent the workpiece from being thrown off by the rotation of the sanding belt.

CAUTION

Hold the workpiece firmly when the back-stop is removed to prevent the workpiece from being thrown. Keep bystanders away from the machine while in operation.

5. Remove the backstop from the sander if the workpiece is longer than the sanding bed.



Curved Sanding

Inside curves can be sanded using the curved end of the sanding belt.

To perform curved sanding operations:

1. Turn the power *ON* and allow the sander to reach full speed.
2. Hold the workpiece against the end of the sanding belt. Move the workpiece slowly across the entire surface of the belt as shown in **Figure 22**.



Figure 22. Sanding an inside curve.





SECTION 7: MAINTENANCE

Maintenance Safety

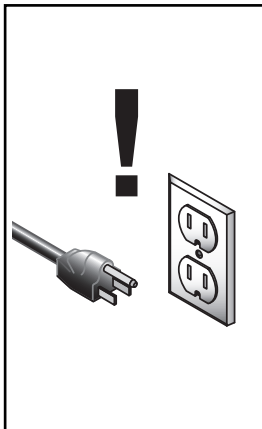
Your safety is important! Please follow the warnings below during this entire section:

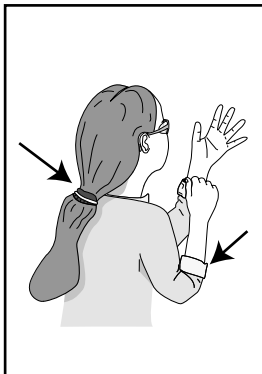
	<p>! WARNING Serious personal injury could occur if you connect your machine to the power source during the maintenance process. DO NOT connect the machine to the power source while performing any maintenance on this machine.</p>
---	---

	<p>! WARNING Loose hair and clothing could get caught in machinery and cause serious personal injury. Keep loose clothing rolled up and long hair tied up and away from machinery.</p>
--	---

	<p>! WARNING Projectiles from the machine could cause serious eye injury. Wear safety glasses at all times.</p>
---	--



Schedule

Check for the following conditions before each use:

- Loose table bolts.
- Worn or damaged sanding discs or belts.
- Worn or damaged wires.
- Any other condition that could hamper the safe operation of this machine.

Perform the following tasks at the scheduled time intervals:

After Each Use

- Wipe off the sawdust build-up from the table surface.
- Turn off power switch and remove the switch key.

Weekly

- Wipe a lubricant such as SLIPIT® onto the table.

Long-Term Storage

- Keep unpainted surfaces rust free with products such as Boeshield® T-9.



Replacing Drive Belt

To replace and tension the drive belt:

1. **Disconnect the machine from the power source!**
2. Remove the drive belt cover plate.
3. Loosen the three screws shown in **Figure 23** and slide the drive belt housing down and remove the old belt.

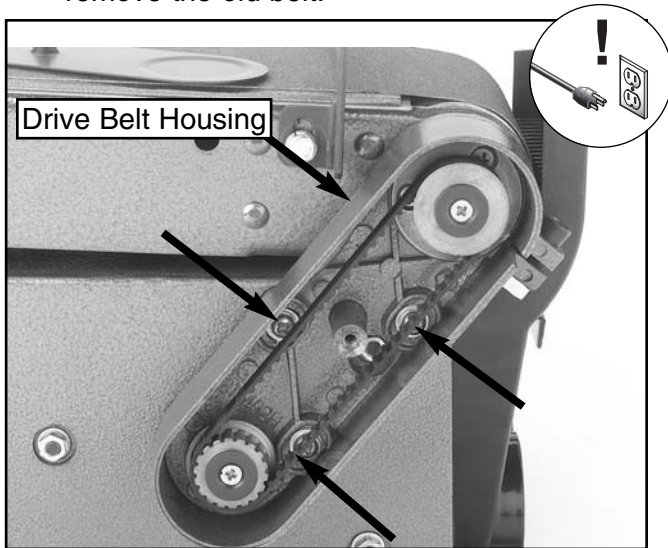

Figure 23. Drive belt housing screws.

4. Place the new belt around the pulley wheels.
5. Put a screwdriver in the tension hole shown in **Figure 24** and pull up to tighten the drive belt.



Figure 24. Tensioning the drive belt.

6. Tighten the drive belt housing screws while keeping tension on the drive belt.
7. Test the belt tension by squeezing the belt between your fingers. There should be no more than ¼" of play in the belt.

Note—*Too much tension in the drive belt will cause increased noise and may overload the motor, however, if the drive belt is too loose it may slip and cause excessive wear on the belt.*



Lubricating Sleeve Bearings

Lubricate the sleeve bearing with 30 WT oil every 10 hours of operation. No other lubrication is necessary for this machine.

To lubricate the sleeve bearings:

1. **Disconnect the machine from the power source!**
2. Remove the sanding belt.
3. Apply two or three drops of oil in the hole at the end of the idler pulley (**Figure 25**).

Note—*DO NOT apply extra oil. Too much oil can cause the belt to slip.*



Figure 25. Lubricating the sleeve bearings.



SECTION 8: REFERENCE INFO

General

This section contains the following subsections for the Model G0547: aftermarket accessories, data sheets, parts diagrams and list, troubleshooting, and warranty/return information.

If you need parts or help in assembling your machine, or if you need operational information, call the service department at (570) 546-9663. Trained service technicians will be glad to help you.

If you have any comments regarding this manual, please write to Grizzly at the address below:

Grizzly Industrial, Inc.
c/o Technical Documentation
P.O. Box 2069
Bellingham, WA 98227-2069

We recommend you keep a copy of our current catalog for complete information regarding Grizzly's warranty and return policy. If you need additional technical information relating to this machine, or if you need general assistance or replacement parts, please contact the Service Department at the location listed below.

Grizzly Industrial, Inc.
1203 Lycoming Mall Circle
Muncy, PA 17756
Phone: (570) 546-9663
Fax: (800) 438-5901
E-Mail: techsupport@grizzly.com
Web Site: <http://www.grizzly.com>



Aftermarket Accessories

To order replacement sanding discs or sanding belts, call our customer service line 24 hours a day at 1-800-523-4777 or visit our website at www.grizzly.com.

EXTRA A/O BELTS:

<u>Grit</u>	<u>Model</u>
60 Grit Belts - 2 pk	G1442
80 Grit Belts - 2 pk	G4279
100 Grit Belts - 2 pk	G1443
120 Grit Belts - 2 pk	G4280
150 Grit Belts - 2 pk	G1444
180 Grit Belts - 2 pk	G4281
220 Grit Belts - 2 pk	G4282

EXTRA PSA A/O DISCS:

<u>Grit</u>	<u>Model</u>
60 Grit Discs - 3 pk	G1445
80 Grit Discs - 3 pk	G4236
100 Grit Discs - 3 pk	G1446
120 Grit Discs - 3 pk	G4237
150 Grit Discs - 3 pk	G1447
180 Grit Discs - 3 pk	G4238
220 Grit Discs - 3 pk	G4239

PRO-STICK® Abrasive Surface Cleaners

Extend the life of your sanding discs and belts!

<u>Size</u>	<u>Model</u>
1½" X 1½" X 8½"	G1511
2" X 2" X 12"	G1512





MACHINE DATA SHEET

Customer Service #: (570) 546-9663 • To Order Call: (800) 523-4777 • Fax #: (800) 438-5901

GRIZZLY MODEL G0547 4" X 36" BELT 6" DISC COMBO SANDER

Design Type..... Bench Model

Overall Dimensions and Specifications:

Height (Belt Horizontal)10³/₄"
 Height (Belt Vertical)23³/₄"
 Width.....14³/₈"
 Length.....17¹/₂"
 Table6¹/₄" x 8⁷/₈"
 Weight38 lbs.
 Footprint6⁵/₈" x 14⁵/₈"

Disc Features:

Disc Size6"
 Disc Speed3450 RPM
 Table Tilt Range.....0-45°

Belt Features:

Belt Size4" x 36"
 Belt Speed1970 RPM
 Belt Tilt Range0-90°

Construction:

BaseCast Iron
 TableDie-Cast Aluminum

Motor:

TypeOPAO Split Phase
 Horsepower¹/₃ HP
 Phase / VoltageSingle Phase / 110V
 Amperage5
 Cycle and RPM60 Hertz / 3450 RPM
 SwitchToggle with Safety Key
 Power TransferDirect Drive/Belt
 BearingsSealed, Permanently Lubricated

Features:

.....2¹/₂" Dust Port
Adjustable Miter Guage
Accepts 6" PSA Discs
Accepts 4" x 36" Sanding Belts
Single Knob Tracking Adjustment

Specifications, while deemed accurate, are not guaranteed.

REF	PART #	DESCRIPTION
1	P0547001	KNOB M6-1 X 27 (MALE)
2	P0547002	RUBBER WASHER
3	P0547003	NOTCHED WASHER
4	P0547004	BED
5	PS75M	PHLP HD SCR M5-.8 X 35
6	PB02M	HEX BOLT M6-1 X 12
7	PLW03M	LOCK WASHER 6MM
8	PW03M	FLAT WASHER 6MM
9	P0547009	BACK STOP
10	P0547010	SANDING BELT 4" X 36"
11	PLW01M	LOCK WASHER 5MM
12	PS09M	PHLP HD SCR M5-.8 X 10
13	P0547013	DRIVE DRUM
14	PSS16M	SET SCREW M8-1.25 X 10
15	P0547015	BEARING CAP
16	P6001	BALL BEARING 6001ZZ
17	P0547017	BEARING SPACER
18	P0547018	SWITCH HOUSING
19	PW02M	FLAT WASHER 5MM
20	PS05M	PHLP HD SCR M5-.8 X 8
21	P0547021	SWITCH KEY
22	P0547022	LOCKING SWITCH
23	PS06M	PHLP HD SCR M5-.8 X 20
24	PHTEK28M	TAP SCREW M4 X 25
25	P0547025	SWITCH BOX COVER
26	P0547026	RELAY
27	P0547027	6" PSA SANDPAPER DISC
28	PSB26M	CAP SCREW M6-1 X 12
29	PLW03M	LOCK WASHER 6MM
30	P0547030	DISC
31	PHTEK4M	TAP SCR M4 X 8
32	P0547032	DISC GUARD
33	P0547033	DISC SHROUD
34	P0547034	DUST COLLECTOR
35	P0547035	DISC TABLE
36	P0547036	TABLE SUPPORT
37	P0547037	ANGLE MEASUREMENT LABEL
38	P0547038	CORD WITH PLUG

REF	PART #	DESCRIPTION
39	P0547039	MOTOR
40	P0547040	WIRE HANGER
41	PN01M	HEX NUT M6-1
42	P0547042	BASE
43	P0547043	DRIVE BELT 140XL037
44	PFH07M	FLAT HD SCR M5-.8 X 10
45	P0547045	COUNTERSUNK WASHER 5MM
46	P0547046	DRIVE PULLEY
47	PS47M	PHLP HD SCR M6-1 X 25
48	PW03M	FLAT WASHER 6MM
49	P0547049	DRIVE PULLEY
50	PFH37M	FLAT HD SCR M5-.8 X 25
51	P0547051	BEARING HOUSING
52	P0547052	BELT COVER
53	P0547053	BED SUPPORT
54	P0547054	SQUARE NUT M8-1.25
55	P0547055	RUBBER BUMPER
56	PSB31M	CAP SCREW M8-1.25 X 25
57	P6001	BALL BEARING 6001ZZ
58	PR03M	EXT RETAINING RING 12MM
59	P0547059	DRIVE SHAFT
60	P0547060	FLANGE NUT M5-.8
61	P0547061	GUIDE SPACER
62	P0547062	INDEX SPRING
63	P0547063	GUIDE DRUM
64	P0547064	IDLER SHAFT
65	P0547065	IDLER DRUM
66	P0547066	TENSION LEVER
67	P0547067	TENSION SPRING
68	P0547068	LEVER SPACER
69	P0547069	BOTTOM COVER PLATE
70	P0547070	WARNING LABEL-ID LABEL
71	P0547071	LABEL-BELT DIRECTION
72	P0547072	LABEL-RESPIRATOR/GLASSES
73	P0547073	LABEL-READ MANUAL
74	P0547074	LABEL-DISCONNECT

Troubleshooting Guide

TROUBLE	CAUSE	CORRECTION
Grains easily rub off the belt or disc.	<ol style="list-style-type: none"> 1. Sanding belt/disc has been stored in an incorrect environment. 2. Sanding belt/disc has been smashed or folded. 	<ol style="list-style-type: none"> 1. Store sanding belt/disc away from extremely hot or dry temperatures. 2. Store sanding belt/disc flat not bent or folded.
Deep sanding grooves or scars in workpiece.	<ol style="list-style-type: none"> 1. Sanding belt/disc grit is too coarse for the desired finish. 2. Workpiece sanded across the grain. 3. Too much sanding force on workpiece. 4. Workpiece held still against the belt/disc. 	<ol style="list-style-type: none"> 1. Use a finer grit sanding belt/disc. 2. Sand with the grain. 3. Reduce pressure on workpiece while sanding. 4. Keep workpiece moving while sanding on the belt/disc.
Sanding surface clogs quickly or burns.	<ol style="list-style-type: none"> 1. Too much pressure against belt/disc. 2. Sanding softwood. 	<ol style="list-style-type: none"> 1. Reduce pressure on workpiece while sanding. 2. Use different stock. Or, accept the characteristics of the stock and plan on cleaning/replacing belts frequently.
Glazed sanding surfaces.	<ol style="list-style-type: none"> 1. Sanding wet stock. 2. Sanding stock with high residue. 	<ol style="list-style-type: none"> 1. Dry stock properly before sanding. 2. Use different stock. Or, accept the characteristics of the stock and plan on cleaning/replacing belts/discs frequently.
Motor will not start.	<ol style="list-style-type: none"> 1. Low voltage. 2. Open circuit in motor or loose connections. 	<ol style="list-style-type: none"> 1. Check power supply for proper voltage. 2. Inspect all lead connections on motor for loose or open connections.
Motor will not start; fuses or circuit breakers blow.	<ol style="list-style-type: none"> 1. Short circuit in line cord or plug. 2. Short circuit in motor or loose connections. 3. Incorrect fuses or circuit breakers in power line. 	<ol style="list-style-type: none"> 1. Inspect cord or plug for damaged insulation and shorted wires. 2. Inspect all connections on motor for loose or shorted terminals or worn insulation. 3. Install correct fuses or circuit breakers.
Motor overheats.	<ol style="list-style-type: none"> 1. Motor overloaded. 2. Incorrect usage of machine. 3. Air circulation through the motor restricted. 	<ol style="list-style-type: none"> 1. Reduce load on motor. 2. Reduce the applied load on the machine. 3. Clean out motor to provide normal air circulation.
Motor stalls (resulting in blown fuses or tripped circuit).	<ol style="list-style-type: none"> 1. Short circuit in motor or loose connections. 2. Low voltage. 3. Incorrect fuses or circuit breakers in power line. 4. Motor overloaded. 	<ol style="list-style-type: none"> 1. Inspect connections on motor for loose or shorted terminals or worn insulation. 2. Correct the low voltage conditions. 3. Install correct fuses or circuit breakers. 4. Reduce load on motor.
Burn marks on workpiece.	<ol style="list-style-type: none"> 1. Using too fine of sanding grit. 2. Using too much pressure. 3. Work held still for too long. 	<ol style="list-style-type: none"> 1. Use a coarser grit sanding belt/disc. 2. Reduce pressure on workpiece while sanding. 3. Do not keep workpiece in one place for too long.
Machine slows when operating.	<ol style="list-style-type: none"> 1. Applying too much pressure to workpiece. 2. Undersized circuit or using ext cord. 	<ol style="list-style-type: none"> 1. Sand with less pressure—let the movement of the belt/disc do the work. 2. Make sure circuit wires are proper gauge & don't use ext cords!
Machine vibrates excessively.	<ol style="list-style-type: none"> 1. Incorrect motor mounting. 2. Incorrect sanding belt tension. 3. Weak or broken tension spring. 4. Idler roller is too loose. 5. Broken/defective sanding belt/disc. 	<ol style="list-style-type: none"> 1. Check/adjust motor mounting. 2. Make sure tension lever is in tensioning position. Follow belt tensioning instructions in this manual. 3. Replace spring. 4. Adjust idler roller. 5. Replace sanding belt/disc.
Workpiece frequently gets pulled out of your hand.	<ol style="list-style-type: none"> 1. Not supporting the workpiece against the stop. 	<ol style="list-style-type: none"> 1. Use back stop to support workpiece.
Workpiece lifts up from sanding disc table.	<ol style="list-style-type: none"> 1. Sanding on the up spinning side of the disc 	<ol style="list-style-type: none"> 1. Sand on the down spinning side of the disc.

Warranty & Returns

Grizzly Industrial, Inc. warrants every product it sells for a period of **1 year** to the original purchaser from the date of purchase. This warranty does not apply to defects due directly or indirectly to misuse, abuse, negligence, accidents, repairs or alterations or lack of maintenance. This is Grizzly's sole written warranty and any and all warranties that may be implied by law, including any merchantability or fitness, for any particular purpose, are hereby limited to the duration of this written warranty. We do not warrant or represent that the merchandise complies with the provisions of any law or acts unless the manufacturer so warrants. In no event shall Grizzly's liability under this warranty exceed the purchase price paid for the product and any legal actions brought against Grizzly shall be tried in the State of Washington, County of Whatcom.

We shall in no event be liable for death, injuries to persons or property or for incidental, contingent, special, or consequential damages arising from the use of our products.

To take advantage of this warranty, contact us by mail or phone and give us all the details. We will then issue you a "Return Number," which must be clearly posted on the outside as well as the inside of the carton. We will not accept any item back without this number. Proof of purchase must accompany the merchandise.

The manufacturers reserve the right to change specifications at any time because they constantly strive to achieve better quality equipment. We make every effort to ensure that our products meet high quality and durability standards and we hope you never need to use this warranty.

Please feel free to write or call us if you have any questions about the machine or the manual.

Thank you again for your business and continued support. We hope to serve you again soon.

WARRANTY CARD

Name _____
Street _____
City _____ State _____ Zip _____
Phone Number _____ E-Mail _____ FAX _____
Model # **G0547 Combo Sander** Serial # _____ Order # _____

The following information is given on a voluntary basis. It will be used for marketing purposes to help us develop better products and services. Of course, all information is strictly confidential.

1. How did you learn about us?
- | | |
|---|------------------------------------|
| <input type="checkbox"/> Advertisement | <input type="checkbox"/> Friend |
| <input type="checkbox"/> Catalog | <input type="checkbox"/> Card Deck |
| <input type="checkbox"/> World Wide Web | |
| <input type="checkbox"/> Other _____ | |
2. Which of the following magazines do you subscribe to.
- | | |
|--|---|
| <input type="checkbox"/> American Woodworker | <input type="checkbox"/> Practical Homeowner |
| <input type="checkbox"/> Cabinetmaker | <input type="checkbox"/> Shop Notes |
| <input type="checkbox"/> Family Handyman | <input type="checkbox"/> Today's Homeowner |
| <input type="checkbox"/> Fine Homebuilding | <input type="checkbox"/> WOOD |
| <input type="checkbox"/> Fine Woodworking | <input type="checkbox"/> Wooden Boat |
| <input type="checkbox"/> Home Handyman | <input type="checkbox"/> Woodshop News |
| <input type="checkbox"/> Journal of Light Construction | <input type="checkbox"/> Woodsmith |
| <input type="checkbox"/> Old House Journal | <input type="checkbox"/> Woodwork |
| <input type="checkbox"/> Popular Mechanics | <input type="checkbox"/> Woodworker |
| <input type="checkbox"/> Popular Science | <input type="checkbox"/> Woodworker's Journal |
| <input type="checkbox"/> Popular Woodworking | <input type="checkbox"/> Workbench |
| <input type="checkbox"/> Other _____ | |
3. Which of the following woodworking/remodeling shows do you watch?
- | | |
|--|--|
| <input type="checkbox"/> Backyard America | <input type="checkbox"/> The New Yankee Workshop |
| <input type="checkbox"/> Home Time | <input type="checkbox"/> This Old House |
| <input type="checkbox"/> The American Woodworker | <input type="checkbox"/> Woodwright's Shop |
| <input type="checkbox"/> Other _____ | |
4. What is your annual household income?
- | | |
|--|--|
| <input type="checkbox"/> \$20,000-\$29,999 | <input type="checkbox"/> \$60,000-\$69,999 |
| <input type="checkbox"/> \$30,000-\$39,999 | <input type="checkbox"/> \$70,000-\$79,999 |
| <input type="checkbox"/> \$40,000-\$49,999 | <input type="checkbox"/> \$80,000-\$89,999 |
| <input type="checkbox"/> \$50,000-\$59,999 | <input type="checkbox"/> \$90,000 + |
5. What is your age group?
- | | |
|--------------------------------|--------------------------------|
| <input type="checkbox"/> 20-29 | <input type="checkbox"/> 50-59 |
| <input type="checkbox"/> 30-39 | <input type="checkbox"/> 60-69 |
| <input type="checkbox"/> 40-49 | <input type="checkbox"/> 70 + |
6. How long have you been a woodworker?
- | | |
|--------------------------------------|---------------------------------------|
| <input type="checkbox"/> 0 - 2 Years | <input type="checkbox"/> 8 - 20 Years |
| <input type="checkbox"/> 2 - 8 Years | <input type="checkbox"/> 20+ Years |
7. How would you rank your woodworking skills?
- | | |
|---------------------------------------|---|
| <input type="checkbox"/> Simple | <input type="checkbox"/> Advanced |
| <input type="checkbox"/> Intermediate | <input type="checkbox"/> Master Craftsman |
8. What stationary woodworking tools do you own? Check all that apply.
- | | |
|--|--|
| <input type="checkbox"/> Air Compressor | <input type="checkbox"/> Panel Saw |
| <input type="checkbox"/> Bandsaw | <input type="checkbox"/> Planer |
| <input type="checkbox"/> Drill Press | <input type="checkbox"/> Power Feeder |
| <input type="checkbox"/> Drum Sander | <input type="checkbox"/> Radial Arm Saw |
| <input type="checkbox"/> Dust Collector | <input type="checkbox"/> Shaper |
| <input type="checkbox"/> Horizontal Boring Machine | <input type="checkbox"/> Spindle Sander |
| <input type="checkbox"/> Jointer | <input type="checkbox"/> Table Saw |
| <input type="checkbox"/> Lathe | <input type="checkbox"/> Vacuum Veneer Press |
| <input type="checkbox"/> Mortiser | <input type="checkbox"/> Wide Belt Sander |
| <input type="checkbox"/> Other _____ | |
9. How many of your woodworking machines are Grizzly? _____
10. Which benchtop tools do you own? Check all that apply.
- | | |
|---|---|
| <input type="checkbox"/> 1" x 42" Belt Sander | <input type="checkbox"/> 6" - 8" Grinder |
| <input type="checkbox"/> 5" - 8" Drill Press | <input type="checkbox"/> Mini Lathe |
| <input type="checkbox"/> 8" Table Saw | <input type="checkbox"/> 10" - 12" Thickness Planer |
| <input type="checkbox"/> 8" - 10" Bandsaw | <input type="checkbox"/> Scroll Saw |
| <input type="checkbox"/> Disc/Belt Sander | <input type="checkbox"/> Spindle/Belt Sander |
| <input type="checkbox"/> Mini Jointer | |
| <input type="checkbox"/> Other _____ | |
11. How many of the machines checked above are Grizzly? _____
12. Which portable/hand held power tools do you own? Check all that apply.
- | | |
|---|--|
| <input type="checkbox"/> Belt Sander | <input type="checkbox"/> Orbital Sander |
| <input type="checkbox"/> Biscuit Joiner | <input type="checkbox"/> Palm Sander |
| <input type="checkbox"/> Circular Saw | <input type="checkbox"/> Portable Planer |
| <input type="checkbox"/> Detail Sander | <input type="checkbox"/> Saber Saw |
| <input type="checkbox"/> Drill/Driver | <input type="checkbox"/> Reciprocating Saw |
| <input type="checkbox"/> Miter Saw | <input type="checkbox"/> Router |
| <input type="checkbox"/> Other _____ | |
13. What machines/supplies would you like Grizzly Industrial to carry?

14. What new accessories would you like Grizzly Industrial to carry?

15. What other companies do you purchase your tools and supplies from?

16. Do you think your purchase represents good value?
 Yes No
17. Would you recommend Grizzly Industrial to a friend?
 Yes No
18. Would you allow us to use your name as a reference for Grizzly customers in your area? **Note: We never use names more than three times.**
 Yes No
19. Comments: _____

CUT ALONG DOTTED LINE

FOLD ALONG DOTTED LINE



Place
Stamp
Here



GRIZZLY INDUSTRIAL, INC.
P.O. BOX 2069
BELLINGHAM, WA 98227-2069



FOLD ALONG DOTTED LINE

Send a Grizzly Catalog to a friend:

Name _____
Street _____
City _____ State _____ Zip _____

TAPE ALONG EDGES--PLEASE DO NOT STAPLE

grizzly.com

TOOL WEBSITE

Buy Direct and Save with Grizzly® – Trusted, Proven and a Great Value!

*Visit Our Website Today And Discover Why
Grizzly® Is The Industry Leader!*

- SECURE ORDERING
- ORDERS SHIPPED WITHIN 24 HOURS
- E-MAIL RESPONSE WITHIN ONE HOUR

-OR-

Call Today For A **FREE**
Full Color Catalog

1-800-523-4777



Free Manuals Download Website

<http://myh66.com>

<http://usermanuals.us>

<http://www.somanuals.com>

<http://www.4manuals.cc>

<http://www.manual-lib.com>

<http://www.404manual.com>

<http://www.luxmanual.com>

<http://aubethermostatmanual.com>

Golf course search by state

<http://golfingnear.com>

Email search by domain

<http://emailbydomain.com>

Auto manuals search

<http://auto.somanuals.com>

TV manuals search

<http://tv.somanuals.com>