

# *Grizzly* *Industrial, Inc.*®

## MODEL H8224 HVLP SPRAY GUN INSTRUCTION MANUAL



COPYRIGHT © AUGUST, 2007 BY GRIZZLY INDUSTRIAL, INC.  
**WARNING: NO PORTION OF THIS MANUAL MAY BE REPRODUCED IN ANY SHAPE  
OR FORM WITHOUT THE WRITTEN APPROVAL OF GRIZZLY INDUSTRIAL, INC.**  
#TR9837 PRINTED IN CHINA

# SAFETY

## **WARNING**

### **For Your Own Safety Read Instruction Manual Before Operating This Equipment**

The purpose of safety symbols is to attract your attention to possible hazardous conditions. This manual uses a series of symbols and signal words which are intended to convey the level of importance of the safety messages. The progression of symbols is described below. Remember that safety messages by themselves do not eliminate danger and are not a substitute for proper accident prevention measures.



Indicates an imminently hazardous situation which, if not avoided, **WILL** result in death or serious injury.



Indicates a potentially hazardous situation which, if not avoided, **COULD** result in death or serious injury.



Indicates a potentially hazardous situation which, if not avoided, **MAY** result in minor or moderate injury. It may also be used to alert against unsafe practices.

**NOTICE**

This symbol is used to alert the user to useful information about proper operation of the equipment.

## **WARNING**

### **Safety Instructions For Spray Guns**

- 1. READ THIS MANUAL.** This gun may cause personal injury if used incorrectly. This manual contains proper safety and operating instructions that must be followed to reduce this risk.
- 2. WEAR EYE PROTECTION.** Material sprayed into eyes may cause serious injury or blindness. Always wear safety goggles ANSI approved for spraying (sealing type) to reduce your risk from this hazard.
- 3. SPRAY IN VENTILATED AREA.** Airborne particles and fumes are toxic and can cause brain damage or death. To reduce your risk, only use the spray gun in a well ventilated area with adequate supply of fresh air.
- 4. WEAR A RESPIRATOR.** Airborne material from spraying can be very hazardous to lungs. Always wear a respirator NIOSH approved for spraying and fumes of your material type; or use a supplied air respirator system that delivers fresh air from an outside location via hoses.
- 5. MAINTAIN EQUIPMENT.** Pressurized spray guns or hoses may burst unexpectedly if damaged or poorly maintained, causing serious injury. Fix air leaks immediately and follow all recommended maintenance. Never operate this spray gun with loose or disassembled components. Never modify the spray gun.

- 6. USE CORRECT AIR PRESSURE.** Exceeding the maximum PSI rating of this spray gun may cause unpredictable operation or bursting.
- 7. DISCONNECT AIR PRESSURE** before servicing, changing accessories, or moving to another location. Never leave this spray gun unattended when connected to air.
- 8. AVOID IGNITION SOURCES.** Spraying around ignition sources may cause fire or an explosion. Do not spray around any ignition sources or potential ignition sources. Be aware of appliances that have pilot lights or machinery that creates sparks during operation. Do not smoke in the spraying area or when spraying.
- 9. FIRE EXTINGUISHERS.** Always have a fully charged multi-class or class B fire extinguisher in the immediate area.
- 10. AVOID UNINTENTIONAL OPERATION.** Always disconnect air when not in use, and do not carry tool with hand on trigger.
- 11. KEEP CHILDREN AWAY.** Avoid injury to children by keeping them away from this spray gun. Disconnect and lock the spray gun away when not in use.
- 12. AVOID USE WHEN TIRED OR ON DRUGS OR ALCOHOL.** Avoid using this spray gun if you are overly tired or intoxicated. Using this spray gun during these times may increase the risk of injury or fire.
- 13. UNTRAINED & UNSUPERVISED USE.** Untrained operators may not be aware of the safe use of this spray gun and may injure themselves or cause fire. All untrained operators must be directly supervised at all times if using this spray gun.
- 14. READ MATERIAL LABELS and MATERIAL SAFETY DATA SHEETS (MSDS).** Read and know all the instructions on the packaging label and the MSDS before opening the package. This information could save your life.
- 15. PROTECTIVE CLOTHING.** Protect exposed skin from overspray by wearing a protective suit or other approved garment.
- 16. INAPPROPRIATE USE.** DO NOT point or shoot spray gun directly at yourself or another person or animals. Do not attempt to use the spray gun for any other use than it was intended.
- 17. STORAGE.** Thoroughly clean and dry spray gun before storage. Store in an approved cabinet.
- 18. BE AWARE OF HOSE LOCATION.** Hoses can easily become a tripping hazard when laid across the floor in a disorganized fashion.
- 19. SOLVENTS.** Always store solvents and shop towels soaked in solvent in approved containers.
- 20. LOCAL LAWS.** Consult local authorities regarding exhaust and waste disposal requirements.

# INTRODUCTION

---

---

## Foreword

---

---

The specifications, details, and photographs in this manual represent the Model H8224 as supplied when the manual was prepared. However, owing to Grizzly's policy of continuous improvement, changes may be made at any time with no obligation on the part of Grizzly.

If you have any comments regarding this manual, please write to us at the following address:

Grizzly Industrial, Inc.  
C/O Technical Documentation  
P.O. Box 2069  
Bellingham, WA 98227-2069  
Email: manuals@grizzly.com

Most importantly, we stand behind our tools. If you have any service questions or parts requests, please call or write us at the location listed below.

Grizzly Industrial, Inc.  
1203 Lycoming Mall Circle  
Muncy, PA 17756  
Phone: (570) 546-9663  
Fax: (800) 438-5901  
E-Mail: techsupport@grizzly.com  
Web Site: <http://www.grizzly.com>

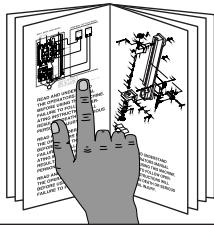
## Specifications

---

---

Cup Size.....	120cc
Feed Type .....	Gravity
Fluid Tip Size.....	0.8mm
Air Consumption.....	4.2–7.1 CFM
Operating Pressure Range.....	44–58 PSI
Max. Air Pressure.....	120 PSI
Cup Material .....	Plastic
Pattern Width.....	7 $\frac{1}{8}$ "-9 $\frac{3}{4}$ " (180–250mm)
Body Material .....	Aluminum
Air Inlet Size .....	$\frac{1}{4}$ " NPT

**⚠ WARNING**



**Read the manual before operation. Become familiar with this tool, its safety instructions, and its operation before beginning any work. Serious personal injury may result if safety or operational information is not understood or followed.**

# SETUP

## Inventory

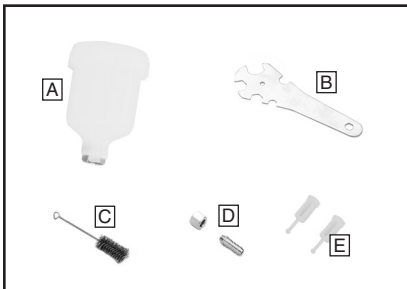
Your spray gun left our warehouse in a carefully packed box. If you discover the spray gun is damaged after you have signed for delivery, *please immediately call Customer Service at (570) 546-9663 for advice.*

Save all packing materials for possible inspection by the carrier or its agent. *Otherwise, filing a shipping claim can be difficult.*

**After you have unpacked the box, you should find the following items with your spray gun:**

Model H8224 Inventory (Figure 1)	Qty
A. Cup 120cc.....	1
B. Multi-Wrench.....	1
C. Cleaning Brush.....	1
D. Barbed Hose Fitting w/Nut.....	1
E. Plastic Filters.....	2

**Note:** *One of the plastic filters may come pre-installed in the spray gun.*



**Figure 1.** Inventory components shipped with Model H8224.

## Assembly & Setup

Before assembling and using the spray gun, thoroughly clean and dry all parts. Please refer to **Cleaning** in the **MAINTENANCE** section on **Page 10** for more detailed instructions. Make sure all connections are tight enough to prevent air leaks but not so tight as to damage the tool.

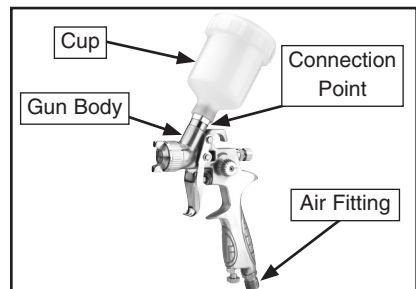
**To setup the spray gun:**

1. Insert the filter into the gun body (see **Figure 2**). **Note:** *One of the plastic filters may come pre-installed in the spray gun; if so, skip this step.*



**Figure 2.** Installing filter.

2. Attach the cup to the gun body as shown in **Figure 3**.



**Figure 3.** Cup installed.

3. Install and tighten the barbed hose fitting to the air inlet with the provided nut; or attach a female 1/4" NPT quick connect fitting (not included) to the air inlet for connection to an air coupler.

**Note:** Using a 1/4" NPT quick disconnect set-up, will make operation and maintenance tasks easier.

4. Attach the spray gun to an air hose regulated between 44 and 58 PSI.

**Note:** For the best results, use a hose that will be dedicated for spray use only. Do not use a hose that has been used with an in-line oiler or other possible contaminant.

If you need additional help with this assembly, call our Technical Support at: (570) 546-9663.

## Controls

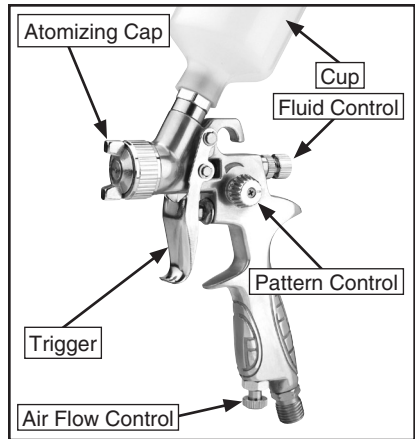


Figure 4. Controls.

- **Fluid Control:** Controls the volume of material that travels through the fluid tip.
- **Pattern Control:** Adjusts the spray pattern from a round pattern to a wide fan.
- **Atomizing Cap:** Controls the spray pattern from vertical to horizontal.
- **Trigger:** Squeeze the trigger half way to blow air, or squeeze all the way to spray.
- **Air Flow Control:** Controls the fluid pressure inside the spray gun.
- **Cup:** Holds up to 120cc of material for spraying.

# OPERATIONS

**! DANGER**



**EXPLOSION HAZARD!**  
DO NOT smoke or allow any source of flame or spark near spraying. Vapors will explode if ignited.

**! WARNING**



**EYE AND RESPIRATORY HAZARD!**  
Always wear ANSI approved goggles and a NIOSH approved respirator when using spray equipment. Failure to protect yourself can lead to severe eye/lung injuries.

**! WARNING**



**TOXIC FUMES!**  
Only spray in well ventilated areas or an approved spray booth. NEVER spray in a confined space where toxic fumes and flammable vapors can accumulate to deadly levels.

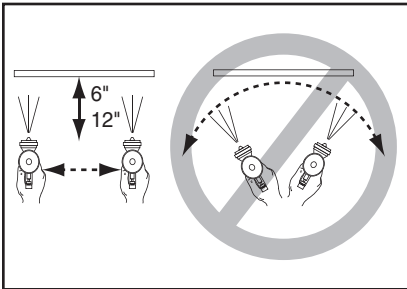
## Spraying

The Model H8224 HVLP spray gun set is designed to spray a wide variety of materials such as lacquers, stains, primers, multi-component paints, clear coats, acrylics, epoxies etc. It is ideal for auto body and woodworking projects.

### To use your spray gun:

1. Read and follow the material manufacturer's instructions for spraying, mixing, safety, disposal, and any other instruction on the label or Material Safety Data Sheet (MSDS).
2. Ensure the cup is securely tightened and all other fittings are secure to avoid air leaks or material spills.
3. Set the inlet air pressure (the air coming to the spray gun) to the lowest pressure recommended in **Specifications** on **Page 3** or to the material manufacturer's recommendations.
4. Adjust the atomizing cap to vertical or horizontal. See **Atomizing Cap and Fan Adjustments** on **Page 8** for further explanation.
5. Fill the cup with material.
6. Trial-and-error are necessary to achieve the results you want along with a fair amount of practice. Test your material flow and spray pattern on a piece of cardboard or some scrap of material similar to your project.

7. Adjust the fluid control knob to start with a low volume of material and keep the atomization as low as possible. You will need to use a combination of fluid control, inlet air pressure, air flow control and stroke speed to achieve the results you want. Spray so the material wets out nicely without running or sagging.
8. Use the pattern control knob to adjust the spray fan to your desired pattern.
9. Keep the gun tip perpendicular, parallel and 6"-12" from the work at all times when spraying, as shown in **Figure 5**. Do not allow your wrist to bend. This will cause the gun to arc across the surface and distribute the material unevenly, possibly creating sags and dry spots.

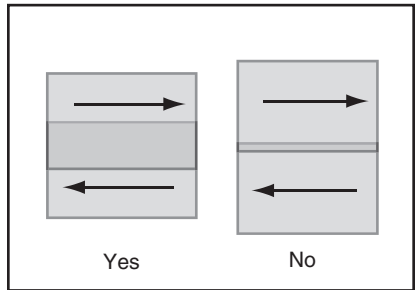


**Figure 5.** Spray technique.

## **NOTICE**

Tipping the spray gun may cause material to spill out of the cup. Always hold the spray gun perpendicular to the ground to avoid potential spills and feed problems.

10. Begin spraying 2-3 inches before the work and continue to the end of the work. Continue the motion for a few inches past the work until you are ready for the return stroke.
11. Maintain an even speed when spraying.
12. Overlap each stroke by 50%. This will ensure even coverage as shown in **Figure 6**. Overlapping less than 50%, as shown in the figure to the right, may lead to missed spots or streaky results.



**Figure 6.** Overlap technique.

13. The spray stroke should have even consistency and parallel edges. If it doesn't, please refer to **Troubleshooting** on **Page 12**.

## **CAUTION**

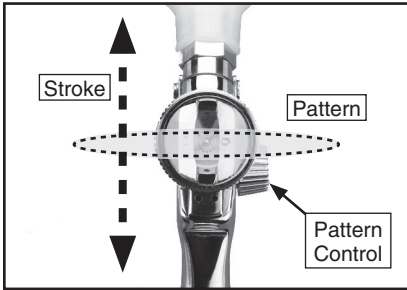
**CONTAMINATION HAZARD!**

Dispose of paint waste in a responsible manner! Follow manufacturer's recommendations and local laws regarding disposal.

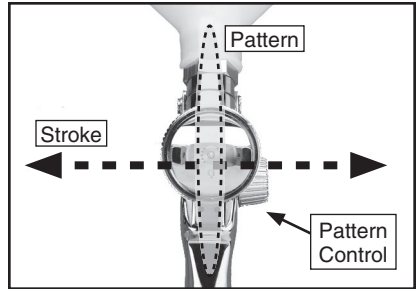


# Atomizing Cap and Fan Adjustments

The atomizing cap can be adjusted for horizontal or vertical spraying patterns. Spraying in the wrong direction may lead to material build up on the atomizing cap horn. Many performance problems are caused by clogged atomizing holes on the atomizing cap horns (see **Cleaning** on **Page 10**).

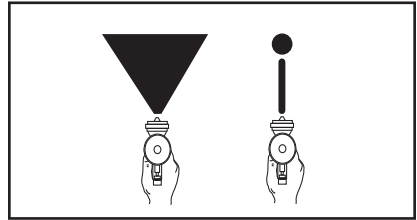


**Figure 7.** Set up for vertical stroke direction with horizontal fan pattern.



**Figure 8.** Set up for horizontal spray stroke with vertical fan pattern.

Rotating the pattern adjustment knob (see **Figure 4**) changes the shape of the spray pattern from a wide spray to a narrow spray, as shown in **Figure 9**.



**Figure 9.** Fan adjustment.

# ACCESSORIES

## **G6261—Campbell Hausfeld™ Water Filter**

Filtering out water and oil before it reaches the spray gun is critical for high quality spraying results. This filter is rated at 150 PSI maximum air pressure, and has a 1/4" NPT air inlet.



**Figure 10.** G6261 Campbell Hausfeld™ water filter.

## **G8114—3/8" x 25 Ft. Air Hose**

## **G8115—3/8" x 50 Ft. Air Hose**

## **G8116—3/8" x 100 Ft. Air Hose**

We recommend dedicating an air hose for spraying use only, keeping it clean and free of water and oil by using a filter on the incoming end. Multi-purpose red rubber air hose is flexible and abrasion resistant. Features 200 PSI rating, 800 PSI bursting strength, and 1/4" NPT ends.



**Figure 11.** Red rubber air hose.

## **H7274—Campbell Hausfeld™ Pressure Regulator**

Since PSI drops as it travels through air hose, attaching a regulator directly to the spray gun ensures accurate air regulation for the best results possible. Provides regulated output pressure of 0 to 125 PSI for proper tool operation. Locking pressure knob prevents accidental adjustments. 15 SCFM flow capacity @ 90 PSI. 1/4" NPT.

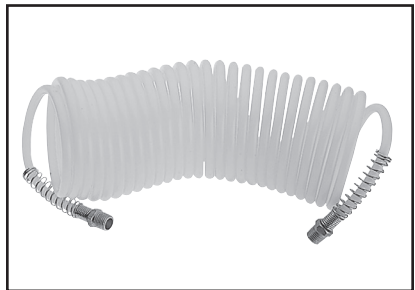


**Figure 12.** H7274 Campbell Hausfeld™ pressure regulator.

## **H3275—1/4" NPT x 25' Recoil Hose**

## **H3276—1/4" NPT x 50' Recoil Hose**

These recoil hoses are great dedicated air hoses because they are extremely light weight and maneuverable, which makes hours of spraying less tiring on wrists and arms.



**Figure 13.** H3275 Coil Hose.

**Call 1-800-523-4777 To Order**

# MAINTENANCE

## Cleaning

Proper cleaning is the best way to ensure trouble free performance from your spray gun. If your gun is not thoroughly cleaned, damage and poor spraying will result. Problems caused by improper cleaning will not be covered by the warranty. Clean the spray gun immediately after each use.

### To clean your spray gun:

1. Empty the cup and spray a small amount of solvent through the gun.

**Note:** *If you are spraying on a regular basis, spraying solvents into the air may be illegal. A cabinet style spray gun cleaner may be required.*

2. DISCONNECT SPRAY GUN FROM AIR!
3. Remove the cup and cup lid.
4. Disassemble the gun by unscrewing the fluid control knob then remove the spring and needle.

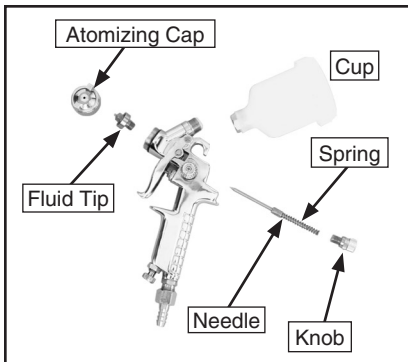


Figure 14. Disassembly for cleaning.

5. Unscrew the atomizing cap and the fluid tip. The fully disassembled gun should look like **Figure 14**.
6. Rinse all parts thoroughly in solvent, then dry with compressed air or let air dry. Try not to expose O-rings to solvent or they may get damaged.  
  
**Note:** *If the small holes in the atomizing cap become blocked, soak in clean solvent. If the blockage still exists, clear the blockage with a small needle, taking great care to not enlarge or damage the hole. Damage to the hole will create a disrupted spray pattern.*
7. Use the cleaning brush with solvent to clean the inner orifice and other hard to reach areas on the outside of the spray gun body.
8. Wipe the gun body with a lint free cloth and lubricate parts (see **Page 11**) before re-assembly.

## **!**WARNING

### EXPLOSION HAZARD!

Chlorinated Solvents like 1,1,1-Trichloroethane and Methylene Chloride (methyl chloride) can chemically react with aluminum spray gun parts and explode. Read solvent label carefully to avoid using solvent with these chemicals.

## NOTICE

DO NOT soak the spray gun body in solvent. Prolonged exposure to solvent will rapidly deteriorate the spray gun washers and seals. Ignoring this notice will void your warranty.

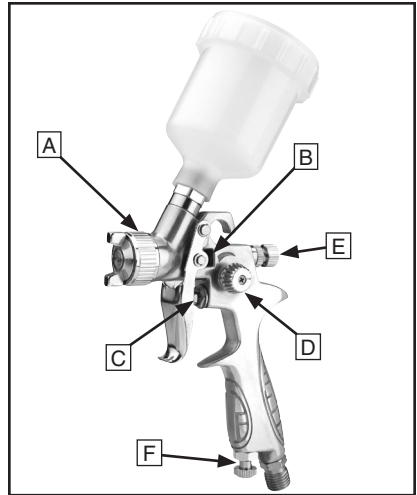
# Lubrication

---

Lubricate the following areas with a non-silicon spray-gun lubricant after cleaning.






- A. Atomizing Cap Threads
- B. Air Valve Packing
- C. Trigger Pin
- D. Pattern Control
- E. Fluid Control Knob
- F. Air Flow Control Knob

Allow the lubricant to coat threads, and run into gun body to lubricate all moving parts and seals.



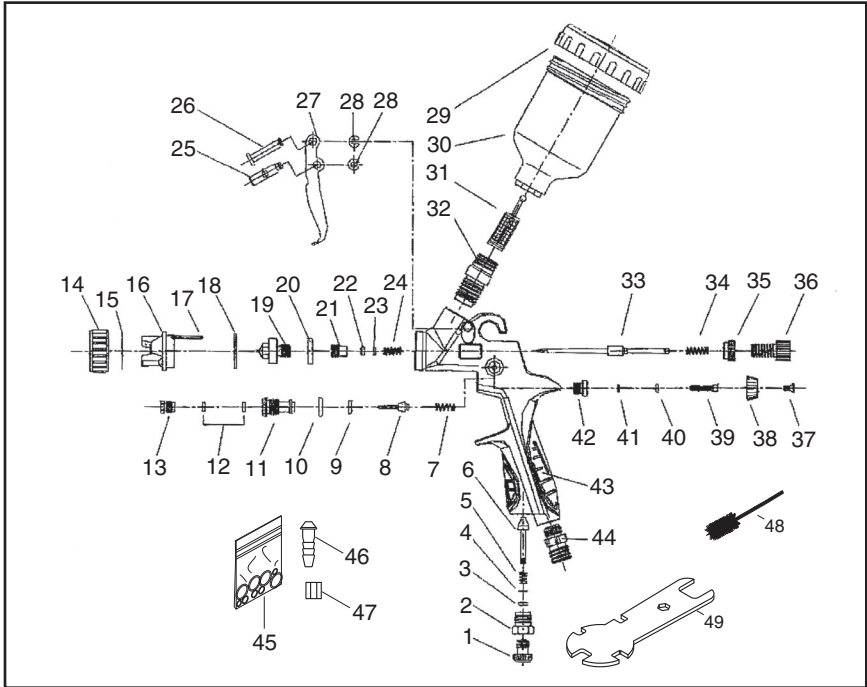
**Figure 15.** General lubrication points.

# Troubleshooting

Symptom	Possible Cause	Solution
Fluttering or spitting spray. 	<ol style="list-style-type: none"> <li>1. Dry or worn fluid tip seat permits air to seep into fluid passage.</li> <li>2. Material level too low.</li> <li>3. Fluid tip or filter obstructed.</li> <li>4. Dry needle packing.</li> </ol>	<ol style="list-style-type: none"> <li>1. Tighten fluid tip or replace seat with new one.</li> <li>2. Add material.</li> <li>3. Clean.</li> <li>4. Lubricate needle.</li> </ol>
Uneven top or bottom pattern. 	<ol style="list-style-type: none"> <li>1. Atomizing cap holes are obstructed.</li> <li>2. Build-up on top or bottom of fluid tip.</li> <li>3. Build-up on atomizing cap is on needle seat.</li> </ol>	<ol style="list-style-type: none"> <li>1. Clear holes.</li> <li>2. Clean.</li> <li>3. Clean.</li> </ol>
Right or left arc pattern. 	<ol style="list-style-type: none"> <li>1. Left or right side horn holes are plugged.</li> <li>2. Build-up on left or right side of fluid tip.</li> <li>3. Build-up of material inside atomizing cap.</li> </ol>	<ol style="list-style-type: none"> <li>1. Clear holes.</li> <li>2. Clean.</li> <li>3. Clean.</li> </ol>
Heavy deposit of material in center. 	<ol style="list-style-type: none"> <li>1. The material flow exceeds the atomizing cap capacity.</li> <li>2. Inlet air pressure is too low.</li> <li>3. Material is too thick.</li> </ol>	<ol style="list-style-type: none"> <li>1. Lower fluid flow.</li> <li>2. Increase inlet air pressure.</li> <li>3. Thin material.</li> </ol>
Narrow center pattern. 	<ol style="list-style-type: none"> <li>1. Volume control turned in too far.</li> <li>2. Inlet air pressure too high.</li> <li>3. Fluid pressure is too low.</li> <li>4. Material is too thin.</li> </ol>	<ol style="list-style-type: none"> <li>1. Increase volume.</li> <li>2. Reduce inlet air pressure.</li> <li>3. Increase fluid pressure.</li> <li>4. Adjust material.</li> </ol>
No spray output.	<ol style="list-style-type: none"> <li>1. No pressure at gun.</li> <li>2. Fluid passages dirty.</li> <li>3. Fluid control closed.</li> <li>4. Out of paint.</li> <li>5. Material too thick.</li> </ol>	<ol style="list-style-type: none"> <li>1. Check air supply.</li> <li>2. Clean gun, remove any obstructions.</li> <li>3. Open.</li> <li>4. Refill.</li> <li>5. Thin to manufacturer's recommendations.</li> </ol>

<b>Symptom</b>	<b>Possible Cause</b>	<b>Solution</b>
Excessive over-spray.	<ol style="list-style-type: none"> <li>1. Fluid pressure too high.</li> <li>2. Gun is too far from surface.</li> <li>3. Spraying too fast.</li> </ol>	<ol style="list-style-type: none"> <li>1. Reduce fluid pressure.</li> <li>2. Keep gun at recommended distance.</li> <li>3. Slow down and maintain consistent, even parallel stroke.</li> </ol>
Unable to control spray fan.	<ol style="list-style-type: none"> <li>1. Pattern adjustment screw is not seating properly.</li> <li>2. Atomizing cap is loose.</li> </ol>	<ol style="list-style-type: none"> <li>1. Clean or replace.</li> <li>2. Tighten atomizing cap.</li> </ol>
Runs and sags.	<ol style="list-style-type: none"> <li>1. Damaged seal.</li> </ol>	<ol style="list-style-type: none"> <li>1. Replace damaged seals.</li> </ol>
Material leaks from cup.	<ol style="list-style-type: none"> <li>1. Cap not secure.</li> <li>2. Cup not tight on gun body.</li> <li>3. Leaking from cap vent hole.</li> </ol>	<ol style="list-style-type: none"> <li>1. Tighten.</li> <li>2. Tighten.</li> <li>3. Hold gun upright; do not tilt.</li> </ol>
Material leaks from gun.	<ol style="list-style-type: none"> <li>1. Fluid tip loose.</li> <li>2. Dry or damaged seals.</li> <li>3. Excessive pressure.</li> </ol>	<ol style="list-style-type: none"> <li>1. Tighten.</li> <li>2. Replace seals.</li> <li>3. Reduce pressure.</li> </ol>
Thick dimpled finish: orange peel appearance.	<ol style="list-style-type: none"> <li>1. Holding gun too close to surface.</li> <li>2. Inlet air pressure too low.</li> <li>3. Material not properly mixed.</li> <li>4. Surface is dirty or oily.</li> </ol>	<ol style="list-style-type: none"> <li>1. Spray at recommended distance.</li> <li>2. Check inlet air pressure.</li> <li>3. Follow manufacturer's instructions.</li> <li>4. More surface prep is required.</li> </ol>
Dry Spray.	<ol style="list-style-type: none"> <li>1. Inlet air pressure too high.</li> <li>2. Gun too far from surface.</li> <li>3. Gun stroke too fast.</li> </ol>	<ol style="list-style-type: none"> <li>1. Lower inlet air pressure.</li> <li>2. Keep gun at recommended distance.</li> <li>3. Slow down and maintain consistent even parallel stroke.</li> </ol>
Gun leaks from fluid tip.	<ol style="list-style-type: none"> <li>1. Debris will not let the needle seat with the fluid tip.</li> </ol>	<ol style="list-style-type: none"> <li>1. Clean or replace both.</li> </ol>
Contaminated paint: fish eye appearance.	<ol style="list-style-type: none"> <li>1. Water or oil in the air line.</li> </ol>	<ol style="list-style-type: none"> <li>1. Install an in-line air filter.</li> <li>2. Replace air line.</li> </ol>

# Parts Breakdown H8224



REF PART #	DESCRIPTION
1	PH8224001 AIR ADJUST SCREW
2	PH8224002 AIR ADJUST KNOB
3	PORS003 O-RING 2.5 X 1.5 S3
4	PH8224004 DOMED SEAL WASHER
5	PH8224005 AIR INLET SPRING
6	PH8224006 AIR INLET VALVE
7	PH8224007 SWITCH SPRING
8	PH8224008 AIR VALVE ASSEMBLY
9	PH8224009 FOAM WASHER
10	PORS005 O-RING 4.5 X 1.5 S5
11	PH8224011 SWITCH KNOB
12	PH8224012 SWITCH WASHER
13	PH8224013 DIRECTION SCREW
14	PH8224014 ATOMIZATION CAP NUT
15	PH8224015 ATOMIZATION CAP WASHER
16	PH8224016 ATOMIZATION CAP
17	PH8224017 STEEL BALL
18	PORS018 O-RING 17.5 X 1.5 S18
19	PH8224019 FLUID NOZZLE
20	PH8224020 FLUID NOZZLE WASHER
21	PH8224021 DIRECTION SCREW
22	PH8224022 NEEDLE WASHER
23	PH8224023 FOAM WASHER
24	PH8224024 COMPRESSION SPRING
25	PH8224025 TRIGGER PIN I

REF PART #	DESCRIPTION
26	PH8224026 TRIGGER PIN II
27	PH8224027 TRIGGER
28	PEC01M E-CLIP 3MM
29	PH8224029 CUP LID
30	PH8224030 CUP 120CC
31	PH8224031 PLASTIC FILTER
32	PH8224032 FLUID INLET JOINT
33	PH8224033 FLUID ADJUST NEEDLE
34	PH8224034 FLUID NEEDLE SPRING
35	PH8224035 FLUID ADJUST LOCK NUT
36	PH8224036 FLUID ADJUST KNOB
37	PH8224037 FLAT HD SCR M2.5-.45 X 8
38	PH8224038 PATTERN ADJUST KNOB
39	PH8224039 PATTERN ADJUST SCREW
40	PORS003 O-RING 2.5 X 1.5 S3
41	PEC16M E-CLIP 2.5MM
42	PH8224042 PATTERN ADJUST NUT
43	PH8224043 GUN BODY
44	PH8224044 AIR INLET JOINT
45	PH8224045 O-RING REPAIR KIT
46	PH8224046 BARBED HOSE FITTING
47	PH8224047 FLARE NUT 1/4" NPT
48	PH8224048 PIPE CLEANER BRUSH
49	PH8224049 M-WRENCH 7/8/10/12/13/16





## Free Manuals Download Website

<http://myh66.com>

<http://usermanuals.us>

<http://www.somanuals.com>

<http://www.4manuals.cc>

<http://www.manual-lib.com>

<http://www.404manual.com>

<http://www.luxmanual.com>

<http://aubethermostatmanual.com>

Golf course search by state

<http://golfingnear.com>

Email search by domain

<http://emailbydomain.com>

Auto manuals search

<http://auto.somanuals.com>

TV manuals search

<http://tv.somanuals.com>