

Grizzly *Industrial, Inc.*®

MODEL H8115/H8117 MINI SPRAY GUN 0.6MM & 0.8MM NOZZLE OWNER'S MANUAL



Model H8115



Model H8117

COPYRIGHT © JANUARY, 2007 BY GRIZZLY INDUSTRIAL, INC.

WARNING: NO PORTION OF THIS MANUAL MAY BE REPRODUCED IN ANY SHAPE OR FORM WITHOUT THE WRITTEN APPROVAL OF GRIZZLY INDUSTRIAL, INC.

#BL8891 PRINTED IN CHINA



WARNING!

Some dust created by power sanding, sawing, grinding, drilling, and other construction activities contains chemicals known to the State of California to cause cancer, birth defects or other reproductive harm. Some examples of these chemical are:

- **Lead from lead-based paints.**
- **Crystalline silica from bricks, cement and other masonry products.**
- **Arsenic and chromium from chemically-treated lumber.**

Your risk from these exposures varies, depending on how often you do this type of work. To reduce your exposure to these chemicals: Work in a well ventilated area, and work with approved safety equipment, such as those dust masks that are specially designed to filter out microscopic particles.

Table of Contents

SECTION 1: SAFETY	4
Safety Instructions for Pneumatic Tools.....	5
Additional Safety Instructions for Spray Guns.....	6
SECTION 2: INTRODUCTION	7
Foreword.....	7
Contact Info	7
Tool Data Sheet.....	8
SECTION 3: SET UP	9
Unpacking.....	9
Inventory	9
H8115 Assembly.....	9
H8117 Assembly.....	9
Controls	10
SECTION 4: OPERATIONS	11
Spraying.....	11
Atomizing Cap and Fan Adjustments	13
SECTION 5: ACCESSORIES	14
SECTION 6: MAINTENANCE	15
Cleaning.....	15
Lubrication	16
Troubleshooting	17
Notes	19
Parts Breakdown H8115.....	20
Parts Breakdown H8117.....	21
WARRANTY AND RETURNS	22

SECTION 1: SAFETY

WARNING

For Your Own Safety Read Instruction Manual Before Operating this Equipment

The purpose of safety symbols is to attract your attention to possible hazardous conditions. This manual uses a series of symbols and signal words which are intended to convey the level of importance of the safety messages. The progression of symbols is described below. Remember that safety messages by themselves do not eliminate danger and are not a substitute for proper accident prevention measures.



Indicates an imminently hazardous situation which, if not avoided, WILL result in death or serious injury.



Indicates a potentially hazardous situation which, if not avoided, COULD result in death or serious injury.



Indicates a potentially hazardous situation which, if not avoided, MAY result in minor or moderate injury. It may also be used to alert against unsafe practices.

NOTICE

This symbol is used to alert the user to useful information about proper operation of the equipment.

WARNING

Safety Instructions for Pneumatic Tools

- KEEP ALL SAFETY DEVICES IN PLACE** and in working order.
- REMOVE ADJUSTING KEYS AND WRENCHES.** Form habit of checking to see that keys and adjusting wrenches are removed from tool before operation.
- KEEP WORK AREA CLEAN.** Cluttered areas and benches invite accidents.
- DO NOT USE IN DANGEROUS ENVIRONMENT.** Do not use pneumatic tools in damp or wet locations, or where any flammable or noxious fumes may exist. Keep work area well lighted.
- KEEP CHILDREN AND VISITORS AWAY.** All children and visitors should be kept at a safe distance from work area.
- MAKE WORKSHOP CHILD PROOF** by locking your shop and shutting off air valves.
- DO NOT FORCE TOOL.** It will do the job better and safer at the rate for which it was designed.
- USE THE RIGHT TOOL.** Do not force tool or attachment to do a job for which it was not designed.
- DO NOT USE UNDER THE INFLUENCE OF DRUGS OR ALCOHOL.**

WARNING

Safety Instructions for Pneumatic Tools

10. **USE PROPER AIR HOSE** for the tool. Make sure your air hose is in good condition and is long enough to reach your work without stretching.
11. **WEAR PROPER APPAREL.** Do not wear loose clothing, gloves, neckties, rings, bracelets, or other jewelry which may get caught in moving parts. Non-slip footwear is recommended. Wear a protective hair covering to contain long hair.
12. **ALWAYS USE SAFETY GLASSES.** Also use a face or dust mask if cutting operation is dusty. Everyday eyeglasses only have impact resistant lenses, they are NOT safety glasses.
13. **WEAR APPROVED HEARING PROTECTION.**
14. **SECURE WORK.** Use clamps or a vise to hold work when practical. It is safer than using your hand and frees both hands to operate tool.
15. **DO NOT OVERREACH.** Keep proper footing and balance at all times.
16. **MAINTAIN TOOLS WITH CARE.** Keep tools lubricated and clean for best and safest performance. Follow instructions for lubricating and changing accessories.
17. **REDUCE THE RISK OF UNINTENTIONAL SPRAYING.** Do not carry tool with hand on trigger and always disconnect from air when not in use.
18. **DISCONNECT TOOLS** before servicing and changing accessories.
19. **USE THE RECOMMENDED ACCESSORIES.** Consult the owner's manual for recommended accessories. The use of improper accessories may cause risk of injury.
20. **CHECK DAMAGED PARTS.** Before further use of the tool, a guard or other part that is damaged should be carefully checked to determine that it will operate properly and perform its intended function. Check for alignment of moving parts, binding of moving parts, breakage of parts, mounting, and any other conditions that may affect its operation. A guard or other part that is damaged should be properly repaired or replaced.
21. **NEVER LEAVE UNATTENDED TOOL CONNECTED TO AIR.** Disconnect the air hose and do not leave tool until it is relieved of any built up pressure.
22. **NEVER ALLOW UNTRAINED USERS TO USE THIS TOOL WHILE UNSUPERVISED.**
23. **IF YOU ARE UNSURE OF THE INTENDED OPERATION, STOP USING THE TOOL.** Seek formal training or research books or magazines that specialize in pneumatic tools.

WARNING

Additional Safety Instructions for Spray Guns

1. **READ THIS MANUAL.** This manual contains proper operating instructions for this spray gun.
2. **READ MATERIAL LABELS and MATERIAL SAFETY DATA SHEETS (MSDS).** Read and know all the instructions on the packaging label and the MSDS specific to the material you intend to apply before opening the package. This information could save your life.
3. **RESPIRATORY PROTECTION.** Always wear a NIOSH approved respirator when spraying or working around finishing materials.
4. **FIRE EXTINGUISHERS.** Always have a fully charged multi class or class B fire extinguisher in the immediate area.
5. **FLAMMABLE MATERIAL.** NEVER spray near open flame or where any spark could occur.
6. **FRESH AIR.** Always provide adequate exhaust to keep area free of built up vapors, NEVER spray in an unventilated area.
7. **DISCONNECT COMPRESSED AIR.** Always disconnect the spray gun from compressed air before cleaning, changing attachments or when performing maintenance of any kind on this tool.
8. **PROTECTIVE CLOTHING.** Protect exposed skin from overspray by wearing a protective suit or other approved garment.
9. **INAPPROPRIATE USE.** DO NOT point or shoot spray gun directly at yourself or another person or animals. Do not attempt to use the spray gun for any other use than it was intended.
10. **STORAGE.** Thoroughly clean and dry spray gun before storage. Store in an approved cabinet.
11. **SOLVENTS.** Always store solvents and shop towels soaked in solvent in approved containers.
12. **EYE PROTECTION.** Wear eye protection whenever spraying or cleaning. Solvents and chemicals can cause serious eye injury, which could lead to blindness.
13. **OPERATING PRESSURE.** DO NOT exceed the recommended inlet air pressure. Excessive pressure could cause the spray gun to blow seals or cause other internal equipment damage.
14. **LOCAL LAWS.** Consult local authorities regarding exhaust and waste disposal requirements.

SECTION 2: INTRODUCTION

Foreword

We are proud to offer the Grizzly Model H8115/H8117 Spray Gun, part of a growing Grizzly family of fine pneumatic tools. When used according to the guidelines set forth in this manual, you can expect years of trouble-free, enjoyable operation, and proof of Grizzly's commitment to customer satisfaction.

It is our pleasure to provide this manual with the Model H8115/H8117. It was written to encourage safety considerations and guide you through general operating procedures and maintenance.

The specifications, details, and photographs in this manual represent the Model H8115/H8117 as supplied when the manual was prepared. However, owing to Grizzly's policy of continuous improvement, changes may be made at any time with no obligation on the part of Grizzly.

Contact Info

If you have any comments regarding this manual, please write to us at the following address:

Grizzly Industrial, Inc.
C/O Technical Documentation
P.O. Box 2069
Bellingham, WA 98227-2069
Email: manuals@grizzly.com

Most importantly, we stand behind our tools. If you have any service questions or parts requests, please call or write us at the location listed below.

Grizzly Industrial, Inc.
1203 Lycoming Mall Circle
Muncy, PA 17756
Phone: (570) 546-9663
Fax: (800) 438-5901
E-Mail: techsupport@grizzly.com
Web Site: <http://www.grizzly.com>

WARNING

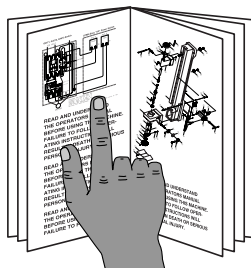

Read the manual before operation. Become familiar with this spray gun, its safety instructions, and its operation before beginning any work. Serious personal injury may result if safety or operational information is not understood or followed.

**MINI SPRAY GUNS
MODEL H8115/H8117**

MODEL	H8115	H8117
CUP SIZE	200ml	150ml
TYPE OF FEED	Gravity	Gravity
FLUID TIP	0.6mm	0.8mm
AIR CONSUMPTION	1.8-2.5 CFM	5 CFM
INLET AIR PRESSURE	3.0-4.0 BAR 45-60 PSI	3.0-4.0 BAR 43-60 PSI
CUP MATERIAL	Stainless Steel	Stainless Steel
MAX. PATTERN WIDTH & DISTANCE	5 ²⁹ / ₃₂ " @ 8"	6 ¹⁹ / ₆₄ " @ 8"
BODY MATERIAL	Polished Metal/Plastic	Polished Metal/Plastic
MATERIAL USAGE	Small to Medium Liquid Particles	Small to Medium Liquid Particles
WATERBORNE MATERIAL COMPATIBLE	Yes	Yes

SECTION 3: SET UP

Unpacking

Your spray gun left our warehouse in a carefully packed box. If you discover the spray gun is damaged after you have signed for delivery, *please immediately call Customer Service at (570) 546-9663 for advice.*

Save the containers and all packing materials for possible inspection by the carrier or its agent. *Otherwise, filing a freight claim can be difficult.*

When you are completely satisfied with the condition of the shipment, you should inventory the equipment.

Inventory

After you have unpacked the carton you should find the following:

Model H8115 Inventory (Figure 1):

- A. Spray Gun 1
- B. Cup 200 ml 1
- C. Cleaning Brush 1
- D. Service Wrench..... 1
- E. Lock Nut..... 1
- F. Barbed Hose Fitting 1

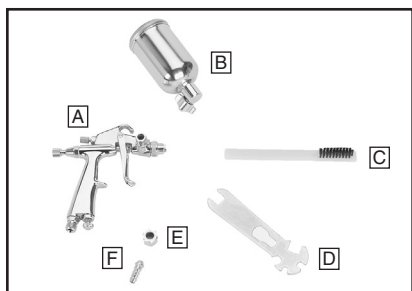

Figure 1. Model H8115 inventory.

Model H8117 Inventory (Figure 2):

- A. Spray Gun 1
- B. Cup 150 ml 1
- C. Lock Nut..... 1
- D. Barbed Hose Fitting 1
- E. Service Wrench..... 1
- F. Cleaning Brushes..... 2
- G. Filters 2

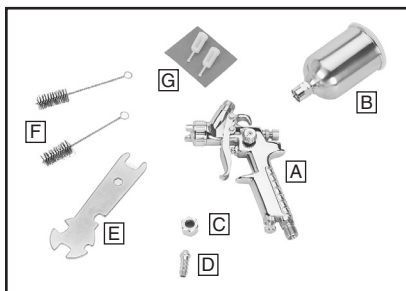

Figure 2. Model H8117 inventory.

H8115 Assembly

Follow **Steps 2-5** of the H8117 Assembly instructions.

H8117 Assembly

1. Insert the filter into the gun body as shown in **Figure 3**.



Figure 3. Installing filter into Model H8117.

2. Screw the cup onto the top of the body.
3. Install the barbed hose fitting into the base of the gun handle and tighten in place with the lock nut.
4. Secure the air hose to the barbed fitting with a hose clamp, or use a 1/4" NPT quick connect fitting (not included).

Note: A 1/4" NPT quick connect set-up will make operation and maintenance tasks easier.

5. Attach the spray gun to an air supply regulated between 45 and 60 PSI.

Note: For the best results, use a hose dedicated for spray use only. Do not use a hose that has been used with an in-line oiler or other possible contaminant.

If you need additional help with this assembly, call our Technical Support at: (570) 546-9663.

Controls

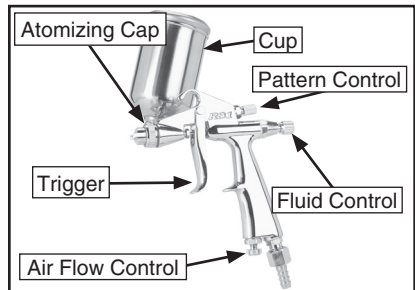

Figure 4. H8115 Controls.

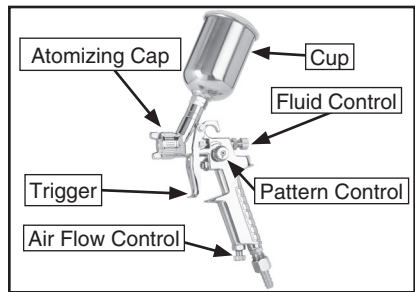

Figure 5. H8117 Controls.

1. **Fluid Control:** Controls the volume of material that travels through the fluid tip.
2. **Pattern Control:** Adjusts the spray pattern from a round pattern to a wide fan.
3. **Air Flow Control:** Controls the fluid pressure inside the spray gun.
4. **Atomizing Cap:** Controls the spray pattern from vertical to horizontal.
5. **Trigger:** Two stage trigger. Stage one only releases compressed air for blowing off the work piece. Stage two sprays material.
6. **Cup:** Holds material; includes a vented cap.

SECTION 4: OPERATIONS

! DANGER



EXPLOSION HAZARD! DO NOT smoke or have any source of flame or spark near spraying. Vapors will explode if ignited.

! WARNING



RESPIRATORY HAZARD! Always use respirator rated for organic vapor and solvent use when using spray equipment. Failure to protect your lungs can lead to respiratory illness and nervous system damage.

! WARNING



TOXIC FUMES! Always use an approved spray booth or well ventilated area when spraying. NEVER spray in a confined space where toxic fumes and flammable vapors can accumulate to deadly levels.

Spraying

The Model H8115/H8117 is designed to spray liquids paints and lacquers that are low viscosity or have been thinned down. It is ideal for auto body touch-ups, wood-working projects, and projects with hard to reach areas.

To use your spray gun:

1. Read and follow the material manufacturer's instructions for spraying, mixing, safety, disposal, and any other instruction on the label or Material Safety Data Sheet (MSDS).
2. Ensure the cup is securely tightened and all other fittings are secure to avoid air leaks or material spills.
3. To start, set the inlet air pressure (the air coming to the spray gun) to the lowest pressure recommended in **Tool Data** on **Page 8** or to the material manufacturer's recommendations. You can adjust as necessary from there.
4. Adjust the atomizing cap to vertical or horizontal. See **Atomizing Cap and Fan Adjustments** on **Page 13** for further explanation.
5. Fill the cup with material.
6. Trial and error are necessary to achieve the results you want along with a fair amount of practice. Test your material flow and spray pattern on a piece of cardboard or scrap material similar to your project.

7. Adjust the fluid control knob to start with a low volume of material and keep the atomization as low as possible. Use a combination of fluid control, inlet air pressure, air flow control and stroke speed to achieve the results you want. Spray so the material wets out nicely without running or sagging.
8. Use the pattern control knob to adjust the spray fan to your desired pattern.
9. Keep the gun tip perpendicular and parallel to the work surface as you spray from a distance of 152-203mm (6-8") as shown in **Figure ??**. Keep your wrist firm while spraying; bending your wrist will cause the gun to arc across the surface and distribute the material unevenly, possibly creating sags, drips or dry spots.

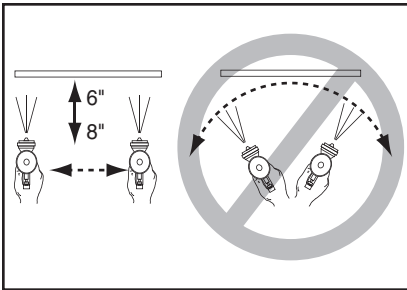

10. Begin spraying 2-3 inches before the work. Continue the motion for a few inches past the work until you are ready for the return stroke.

NOTICE

Tipping the Model H8117 spray gun may cause material to spill out of the cup. Always hold the spray gun perpendicular to the ground to avoid potential spills and gravity feed problems.

11. Maintain an even speed when spraying.
12. Overlap each stroke by 50%. This will ensure even coverage as shown in **Figure 6**. Less than 50% as shown in the figure to the right may lead to missed spots or streaky results.

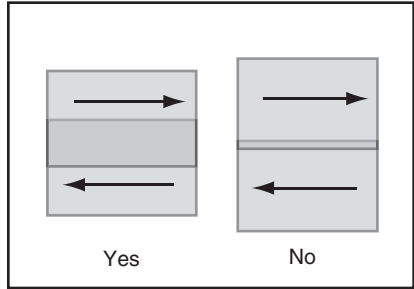

Figure 6. Overlap technique.

13. Spray stroke should be consistently even with parallel edges. If it doesn't please refer to **Troubleshooting** on **Page 17**.
14. To orient the H8115 spray gun downward or upward, loosen the nut that secures the cup to the gun, adjust the gun angle and tighten the nut.

! WARNING

HEALTH & CONTAMINATION HAZARD! Dispose of paint waste in a responsible manner! Follow manufacturer's recommendations and local laws regarding disposal. Failure to comply will result in contamination and possibly large fines and penalties.

Atomizing Cap and Fan Adjustments

The atomizing cap needs to be adjusted for horizontal (**Figure 7 & 8**) or vertical (**Figure 9 & 10**) spraying patterns. Spraying in the opposite direction may lead to material build up on the atomizing cap horn. Many performance problems are caused by clogged atomizing holes on the atomizing cap horns (see **Cleaning** on **Page 15**).

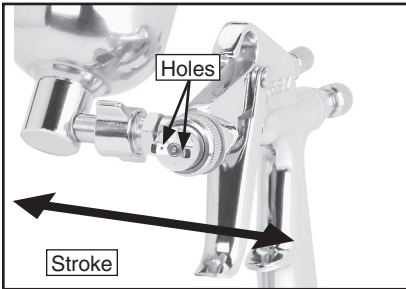

Figure 7. Set up for horizontal stroke, Model H8115.

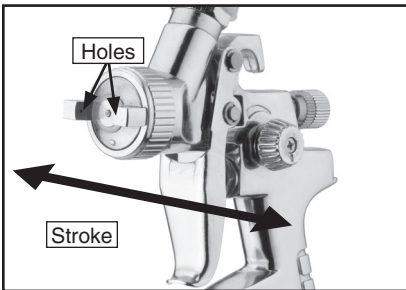

Figure 8. Set up for horizontal stroke, Model H8117.

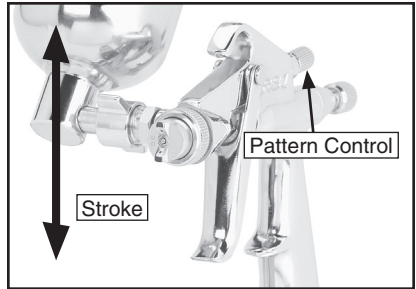

Figure 9. Set up for vertical spray stroke, Model H8115.

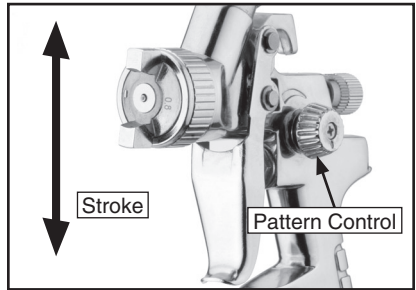

Figure 10. Set up for vertical spray stroke, Model H8117.

Rotating the pattern adjustment control in **Figure 9** or **10** will give you a range between the two patterns in **Figure 11**.

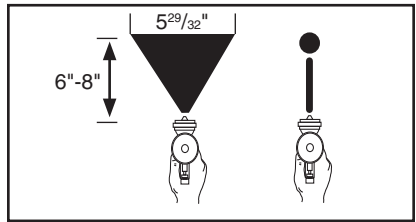

Figure 11. Fan adjustment, Model H8115.

SECTION 5: ACCESSORIES

G6261—Campbell Hausfeld™ Water Filter

Remove damaging water vapor before it reaches your pneumatic tools. This highly effective, five micron filter features a see-through bowl and easy in-line connections. 150 PSI maximum air pressure. ¼" NPT.



Figure 12. G6261 Campbell Hausfeld™ water filter.

G8114—¾" x 25 Ft. Air Hose

G8115—¾" x 50 Ft. Air Hose

G8116—¾" x 100 Ft. Air Hose

Multi-purpose red rubber air hose is flexible and abrasion resistant. Rated for 200 PSI, this air hose has a bursting strength of 800 PSI and ¼" NPT ends.



Figure 13. Red rubber air hose.

H7274—Campbell Hausfeld™ Pressure Regulator

Provides regulated output pressure of 0 to 125 PSI for proper tool operation. Locking pressure knob prevents accidental adjustments. 15 SCFM flow capacity @ 90 PSI. ¼" NPT.



Figure 14. H7274 Campbell Hausfeld™ pressure regulator.

H3174—Air Blow Gun with 2 Tips

This air blow gun includes a safety tip and rubber tip for all normal air cleaning jobs. ¼" NPT.



Figure 15. H3174 Air Blow Gun with 2 Tips.

SECTION 6: MAINTENANCE

Cleaning

Proper cleaning is the best way to ensure trouble free performance from your spray gun. If your gun is not thoroughly cleaned, damage and poor spraying will result. Problems caused by improper cleaning will not be covered by the warranty. Clean the spray gun immediately after each use.

To clean your spray gun:

1. Spray a small amount of solvent through the spray gun.

Note: Check with local laws regarding this practice. If you are spraying on a regular basis, spraying solvents into the air may be illegal. A cabinet style spray gun cleaner may be required.

2. **Disconnect the gun from the air supply!**
3. Unscrew the cup.
4. Disassemble the gun by unscrewing the fluid control knob and removing the spring and needle.

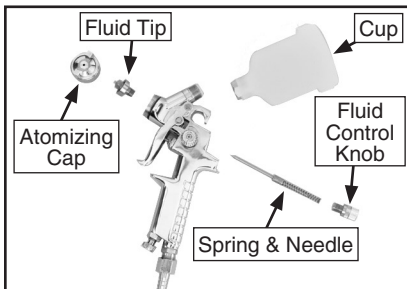

Figure 16. Typical disassembly for cleaning.

5. Unscrew the atomizing cap with your fingers and the fluid tip with the service wrench. The fully disassembled gun should look like **Figure 16**.
6. Rinse these parts thoroughly in solvent then dry with compressed air or let air dry.

Note: If the small holes in the atomizing cap become blocked, soak in clean solvent. If the blockage still exists, taking great care to not enlarge or damage the hole. Damage to the hole will create a disrupted spray pattern.

7. Use the cleaning brush with solvent to clean the inner orifice and other hard to reach areas on the outside of the spray gun body.
8. Wipe the rest of the gun body with a shop towel and dry.

⚠ WARNING

EXPLOSION HAZARD! Chlorinated Solvents like Trichloroethane and Methylene Chloride (methyl chloride) can chemically react with aluminum and may explode. Many parts in spray guns are made of aluminum. Read solvent label carefully before using solvent.

NOTICE

DO NOT soak the spray gun body in solvent. Prolonged exposure to solvent will rapidly deteriorate the spray gun washers and seals. Ignoring this notice will void your warranty.

Lubrication

Lubricate the following areas on the Model H8115 (**Figure 17**) and Model H8117 (**Figure 18**) with spray oil, grease, or petroleum jelly after cleaning.

- A. Atomizing Cap Threads
- B. Air Valve Packing
- C. Trigger Pin
- D. Air Flow Control Valve
- E. Pattern Control
- F. Fluid Control Knob

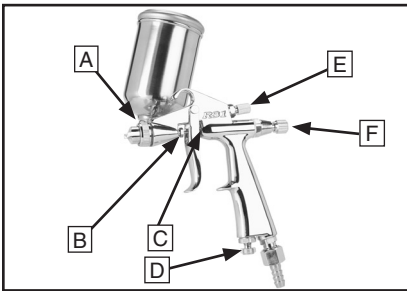

Figure 17. Lubrication points, Model H8115.

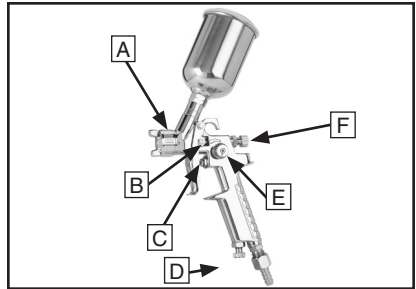







Figure 18. Lubrication points, Model H8117.

After each cleaning apply a thin film of petroleum jelly to the needle spring before reassembling.

Troubleshooting

Symptom	Possible Cause	Solution
Fluttering or Spitting spray. 	<ol style="list-style-type: none"> 1. Dry or worn fluid tip seat permits air to seep into fluid passage. 2. Material level too low. 3. Fluid tip or filter obstructed. 4. Dry needle packing. 	<ol style="list-style-type: none"> 1. Tighten fluid tip or replace seat with new one. 2. Add material. 3. Clean 4. Lubricate needle.
Uneven top or bottom pattern. 	<ol style="list-style-type: none"> 1. Atomizing cap holes are obstructed. 2. Build-up on top or bottom of fluid tip. 3. Build-up on atomizing cap is on needle seat. 	<ol style="list-style-type: none"> 1. Clear holes. 2. Clean. 3. Clean.
Right or left arc pattern. 	<ol style="list-style-type: none"> 1. Left or right side horn holes are plugged. 2. Build-up on left or right side of fluid tip. 3. Build-up of material inside atomizing cap. 	<ol style="list-style-type: none"> 1. Clear holes. 2. Clean. 3. Clean.
Heavy deposit of material in center. 	<ol style="list-style-type: none"> 1. The material flow exceeds the atomizing cap capacity. 2. Inlet air pressure is too low. 3. Material is too thick. 	<ol style="list-style-type: none"> 1. Lower fluid flow. 2. Increase inlet air pressure. 3. Thin material.
Narrow center pattern. 	<ol style="list-style-type: none"> 1. Volume control turned in too far. 2. Inlet air pressure too high. 3. Fluid pressure is too low. 4. Material is too thin. 	<ol style="list-style-type: none"> 1. Increase volume. 2. Reduce inlet air pressure. 3. Increase fluid pressure. 4. Adjust material.
No spray output.	<ol style="list-style-type: none"> 1. No pressure at gun. 2. Fluid passages dirty. 3. Fluid control closed. 4. Out of paint. 	<ol style="list-style-type: none"> 1. Check air supply. 2. Clean gun, remove any obstructions. 3. Open. 4. Refill.

Symptom	Possible Cause	Solution
Excessive over-spray.	<ol style="list-style-type: none"> 1. Fluid pressure too high. 2. Gun is too far from surface. 3. Spraying too fast. 	<ol style="list-style-type: none"> 1. Reduce fluid pressure. 2. Keep gun at recommended distance. 3. Slow down and maintain consistent, even parallel stroke.
Unable to control spray fan.	<ol style="list-style-type: none"> 1. Pattern adjustment screw is not seating properly. 2. Atomizing cap is loose. 	<ol style="list-style-type: none"> 1. Clean or replace. 2. Tighten atomizing cap.
Runs and sags.	<ol style="list-style-type: none"> 1. Damaged seal. 	<ol style="list-style-type: none"> 1. Replace damaged seals.
Material leaks from cup.	<ol style="list-style-type: none"> 1. Cap not secure. 2. Cup not tight on gun body. 3. Leaking from cap vent hole. 	<ol style="list-style-type: none"> 1. Tighten. 2. Tighten. 3. Hold gun upright do not tilt.
Material leaks from gun.	<ol style="list-style-type: none"> 1. Fluid tip loose. 2. Dry or damaged seals. 3. Excessive pressure. 	<ol style="list-style-type: none"> 1. Tighten. 2. Replace seals. 3. Reduce pressure.
Thick dimpled finish aka "Orange Peel."	<ol style="list-style-type: none"> 1. Holding gun too close to surface. 2. Inlet air pressure too low. 3. Material not properly mixed. 4. Surface is dirty or oily. 	<ol style="list-style-type: none"> 1. Spray at recommended distance. 2. Check inlet air pressure. 3. Follow manufacturer's instructions. 4. More surface prep is required.
Dry Spray.	<ol style="list-style-type: none"> 1. Inlet air pressure too high. 2. Gun too far from surface. 3. Gun stroke too fast. 	<ol style="list-style-type: none"> 1. Lower inlet air pressure. 2. Keep gun at recommended distance. 3. Slow down and maintain consistent even parallel stroke.
Gun leaks from fluid tip.	<ol style="list-style-type: none"> 1. Debris will not let the needle seat with the fluid tip. 	<ol style="list-style-type: none"> 1. Clean or replace both.
Contaminated paint.	<ol style="list-style-type: none"> 1. Water or oil in the air line. 	<ol style="list-style-type: none"> 1. Install an in-line air filter, or replace air line.

Parts Breakdown H8115

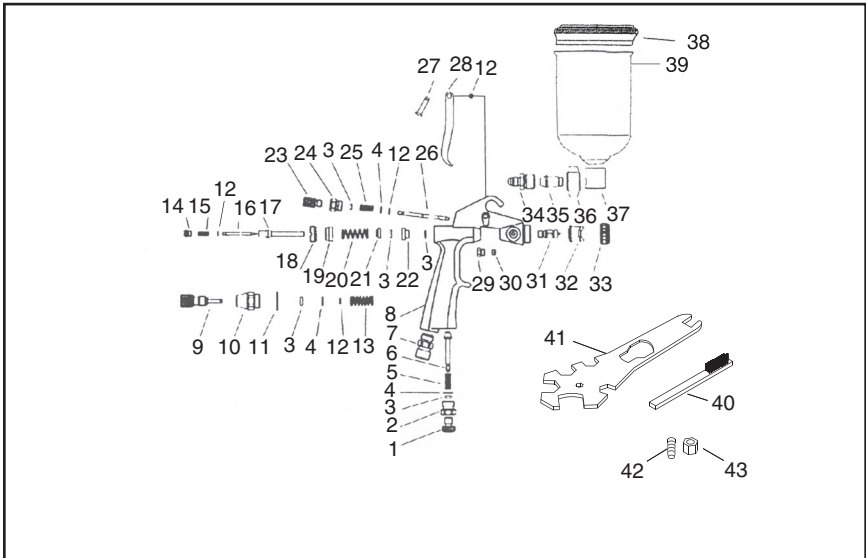

REF PART # DESCRIPTION

1	PH8115001	AIR FLOW CONTROL
2	PH8115002	AIR FLOW CONTROL KNOB
3	PH8115003	O-RING
4	PH8115004	FLAT WASHER
5	PH8115005	AIR VALVE SPRING
6	PH8115006	AIR INLET VALVE POLE
7	PH8115007	AIR INLET PLUG
8	PH8115008	GUN BODY
9	PH8115009	FLUID CONTROL KNOB
10	PH8115010	NEEDLE ADJ. KNOB
11	PH8115011	PLASTIC WASHER
12	PEC14M	E-CLIP 2MM
13	PH8115013	SWITCH SPRING
14	PH8115014	SPRING HOUSING BOLT
15	PH8115015	NEEDLE SPRING
16	PH8115016	FLUID CONTROL NEEDLE
17	PH8115017	SPRING HOUSING
18	PH8115018	COMPRESSION BOLT
19	PH8115019	NEEDLE SEAL WASHER
20	PH8115020	COMPRESSION SPRING
21	PH8115021	SPRING WASHER
22	PH8115022	NEEDLE WASHER

REF PART # DESCRIPTION

23	PH8115023	PATTERN CONTROL BOLT
24	PH8115024	PATTERN CONTROL KNOB
25	PH8115025	PATTERN CONTROL SPRING
26	PH8115026	PATTTERN CONTROL NEEDLE
27	PH8115027	TRIGGER PIN
28	PH8115028	TRIGGER
29	PH8115029	SEAL BOLT
30	PH8115030	WASHER
31	PH8115031	FLUID NOZZLE
32	PH8115032	ATOMIZING CAP
33	PH8115033	ROUND NUT
34	PH8115034	PAINT INLET PLUG
35	PH8115035	PAINT INLET CONNECTOR
36	PH8115036	BUTTERFLY NUT
37	PH8115037	CUP KNOB
38	PH8115038	LID
39	PH8115039	CUP
40	PH8115040	CLEANING BRUSH
41	PH8115041	SERVICE WRENCH
42	PH8115042	BARBED HOSE FITTING
43	PH8115043	LOCK NUT

Parts Breakdown H8117

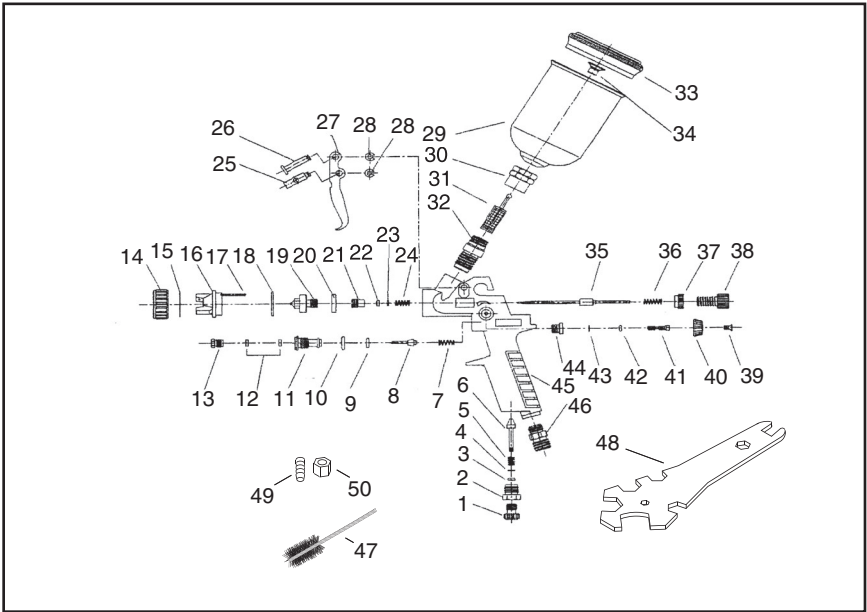

REF PART #	DESCRIPTION
1	PH8117001 AIR FLOW CONTROL SCR.
2	PH8117002 AIR FLOW CONTROL KNOB
3	PH8117003 O-RING
4	PH8117004 DOMED SEAL WASHER
5	PH8117005 AIR VALVE SPRING
6	PH8117006 AIR INLET VALVE
7	PH8117007 SWITCH SPRING
8	PH8117008 AIR INLET VALVE ASSY
9	PH8117009 BUBBLE WASHER
10	PH8117010 O-RING 4.9 X 1.5
11	PH8117011 SWITCH KNOB
12	PH8117012 SWITCH WASHER
13	PH8117013 LOCK SCREW
14	PH8117014 NOZZLE NUT
15	PH8117015 AIR CAP WASHER
16	PH8117016 ATOMIZING CAP
17	PH8117017 STEEL BALL
18	PH8117018 O-RING 17 X 1.5
19	PH8117019 FLUID NOZZLE 0.8MM
20	PH8117020 FLUID NOZZLE WASHER
21	PH8117021 DIRECTION SCREW
22	PH8117022 ADJ. NEEDLE WASHER
23	PH8117023 WASHER
24	PH8117024 COMPRESSION SPRING
25	PH8117025 TRIGGER PIN I

REF PART #	DESCRIPTION
26	PH8117026 TRIGGER PIN II
27	PH8117027 TRIGGER
28	PEC01M E-CLIP 3MM
29	PH8117029 CUP
30	PH8117030 JOINT NUT
31	PH8117031 FILTER
32	PH8117032 FLUID INLET JOINT
33	PH8117033 LID
34	PH8117034 SMALL JOINT NUT
35	PH8117035 FLUID NEEDLE 0.6MM
36	PH8117036 FLUID NEEDLE SPRING
37	PH8117037 JOINT CAP
38	PH8117038 FLUID CONTROL KNOB
39	PS52M PHLP HD SCR M4-.7 X 20
40	PH8117040 PATTERN CONTROL CAP
41	PH8117041 PATTERN CONTROL SCR.
42	PH8117042 O-RING
43	PEC02M E-CLIP 4MM
44	PH8117044 PATTERN CONTROL KNOB
45	PH8117045 GUN BODY
46	PH8117046 AIR INLET JOINT
47	PH8117047 CLEANING BRUSH
48	PH8117048 SERVICE WRENCH
49	PH8117049 BARBED HOSE FITTING
50	PH8117050 LOCK NUT

WARRANTY AND RETURNS

Grizzly Industrial, Inc. warrants every product it sells for a period of **1 year** to the original purchaser from the date of purchase. This warranty does not apply to defects due directly or indirectly to misuse, abuse, negligence, accidents, repairs or alterations or lack of maintenance. This is Grizzly's sole written warranty and any and all warranties that may be implied by law, including any merchantability or fitness, for any particular purpose, are hereby limited to the duration of this written warranty. We do not warrant or represent that the merchandise complies with the provisions of any law or acts unless the manufacturer so warrants. In no event shall Grizzly's liability under this warranty exceed the purchase price paid for the product and any legal actions brought against Grizzly shall be tried in the State of Washington, County of Whatcom.

We shall in no event be liable for death, injuries to persons or property or for incidental, contingent, special, or consequential damages arising from the use of our products.

To take advantage of this warranty, contact us by mail or phone and give us all the details. We will then issue you a "Return Authorization Number," which must be clearly posted on the outside as well as the inside of the carton. We will not accept any item back without this number. Proof of purchase must accompany the merchandise.

The manufacturers reserve the right to change specifications at any time because they constantly strive to achieve better quality equipment. We make every effort to ensure that our products meet high quality and durability standards and we hope you never need to use this warranty.

Please feel free to write or call us if you have any questions about the machine or the manual.

Grizzly Industrial, Inc.
1203 Lycoming Mall Circle
Muncy, PA 17756
Phone: (570) 546-9663
Fax: (800) 438-5901

E-Mail:
techsupport@grizzly.com

Web Site: <http://www.grizzly.com>

Thank you again for your business and continued support. We hope to serve you again soon!



WARRANTY CARD

Name _____

Street _____

City _____ State _____ Zip _____

Phone # _____ Email _____ Invoice # _____

Model # _____ Order # _____ Serial # _____

*The following information is given on a voluntary basis. It will be used for marketing purposes to help us develop better products and services. **All information is strictly confidential.***

1. How did you learn about us?

Advertisement Friend Catalog
 Card Deck Website Other: _____

2. Which of the following magazines do you subscribe to?

Cabinet Maker Popular Mechanics Today's Homeowner
 Family Handyman Popular Science Wood
 Hand Loader Popular Woodworking Wooden Boat
 Handy Practical Homeowner Woodshop News
 Home Shop Machinist Precision Shooter Woodsmith
 Journal of Light Cont. Projects in Metal Woodwork
 Live Steam RC Modeler Woodworker West
 Model Airplane News Rifle Woodworker's Journal
 Modeltec Shop Notes Other:
 Old House Journal Shotgun News

3. What is your annual household income?

\$20,000-\$29,000 \$30,000-\$39,000 \$40,000-\$49,000
 \$50,000-\$59,000 \$60,000-\$69,000 \$70,000+

4. What is your age group?

20-29 30-39 40-49
 50-59 60-69 70+

5. How long have you been a woodworker/metalworker?

0-2 Years 2-8 Years 8-20 Years 20+ Years

6. How many of your machines or tools are Grizzly?

0-2 3-5 6-9 10+

7. Do you think your machine represents a good value? Yes No

8. Would you recommend Grizzly Industrial to a friend? Yes No

9. Would you allow us to use your name as a reference for our customers in your area?

Note: *We never use names more than 3 times.* Yes No

10. Comments: _____

Send a Grizzly Catalog to a friend:

Name _____
Street _____
City _____ State _____ Zip _____

FOLD ALONG DOTTED LINE



Place
Stamp
Here



GRIZZLY INDUSTRIAL, INC.
P.O. BOX 2069
BELLINGHAM, WA 98227-2069



TAPE ALONG EDGES--PLEASE DO NOT STAPLE

Free Manuals Download Website

<http://myh66.com>

<http://usermanuals.us>

<http://www.somanuals.com>

<http://www.4manuals.cc>

<http://www.manual-lib.com>

<http://www.404manual.com>

<http://www.luxmanual.com>

<http://aubethermostatmanual.com>

Golf course search by state

<http://golfingnear.com>

Email search by domain

<http://emailbydomain.com>

Auto manuals search

<http://auto.somanuals.com>

TV manuals search

<http://tv.somanuals.com>