

Grizzly *Industrial, Inc.*®

HVLP SPRAY GUN SET

MODEL H7671/H7672

INSTRUCTION MANUAL

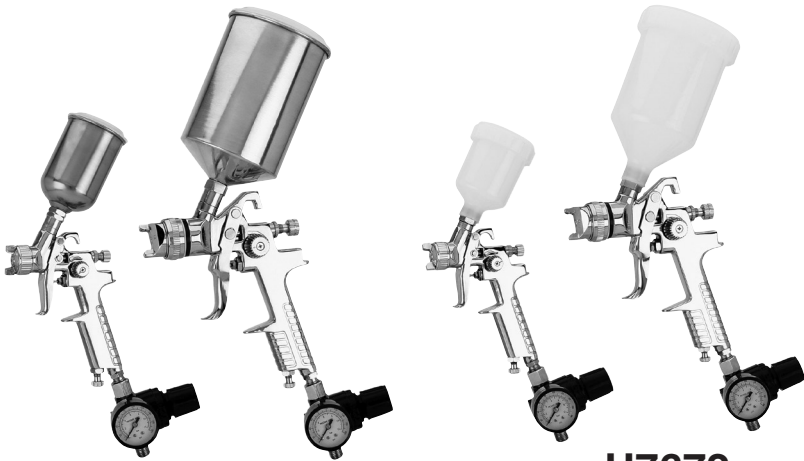

H7671

H7672

COPYRIGHT © JULY, 2005 BY GRIZZLY INDUSTRIAL, INC. REVISED APRIL, 2011 (TR)
**WARNING: NO PORTION OF THIS MANUAL MAY BE REPRODUCED IN ANY SHAPE
OR FORM WITHOUT THE WRITTEN APPROVAL OF GRIZZLY INDUSTRIAL, INC.**
#PC7426 PRINTED IN CHINA

WARNING!

This manual provides critical safety instructions on the proper setup, operation, maintenance, and service of this machine/tool. Save this document, refer to it often, and use it to instruct other operators.

Failure to read, understand and follow the instructions in this manual may result in fire or serious personal injury—including amputation, electrocution, or death.

The owner of this machine/tool is solely responsible for its safe use. This responsibility includes but is not limited to proper installation in a safe environment, personnel training and usage authorization, proper inspection and maintenance, manual availability and comprehension, application of safety devices, cutting/sanding/grinding tool integrity, and the usage of personal protective equipment.

The manufacturer will not be held liable for injury or property damage from negligence, improper training, machine modifications or misuse.

WARNING!

Some dust created by power sanding, sawing, grinding, drilling, and other construction activities contains chemicals known to the State of California to cause cancer, birth defects or other reproductive harm. Some examples of these chemicals are:

- Lead from lead-based paints.
- Crystalline silica from bricks, cement and other masonry products.
- Arsenic and chromium from chemically-treated lumber.

Your risk from these exposures varies, depending on how often you do this type of work. To reduce your exposure to these chemicals: Work in a well ventilated area, and work with approved safety equipment, such as those dust masks that are specially designed to filter out microscopic particles.

SECTION 1: SAFETY

WARNING

For Your Own Safety Read Instruction Manual Before Operating This Equipment

The purpose of safety symbols is to attract your attention to possible hazardous conditions. This manual uses a series of symbols and signal words which are intended to convey the level of importance of the safety messages. The progression of symbols is described below. Remember that safety messages by themselves do not eliminate danger and are not a substitute for proper accident prevention measures.

 **DANGER** Indicates an imminent hazardous situation which, if not avoided, **WILL** result in death or serious injury.

 **WARNING** Indicates a potentially hazardous situation which, if not avoided, **COULD** result in death or serious injury.

 **CAUTION** Indicates a potentially hazardous situation which, if not avoided, **MAY** result in minor or moderate injury. It may also be used to alert against unsafe practices.

NOTICE This symbol is used to alert the user to useful information about proper operation of the equipment.

WARNING

Safety Instructions For Pneumatic Tools

- KEEP ALL SAFETY DEVICES IN PLACE** and in working order.
- REMOVE ADJUSTING KEYS AND WRENCHES.** Form habit of checking to see that keys and adjusting wrenches are removed from tool before operation.
- KEEP WORK AREA CLEAN.** Cluttered areas and benches invite accidents.
- DO NOT USE IN DANGEROUS ENVIRONMENT.** Do not use pneumatic tools in damp or wet locations, or where any flammable or noxious fumes may exist. Keep work area well lighted.
- KEEP CHILDREN AND VISITORS AWAY.** All children and visitors should be kept at a safe distance from work area.
- MAKE WORKSHOP CHILD PROOF** by locking your shop and shutting off air valves.
- DO NOT FORCE TOOL.** It will do the job better and safer at the rate for which it was designed.
- USE THE RIGHT TOOL.** Do not force tool or attachment to do a job for which it was not designed.
- DO NOT USE UNDER THE INFLUENCE OF DRUGS OR ALCOHOL.**

WARNING

Safety Instructions For Pneumatic Tools

10. **USE PROPER AIR HOSE** for the tool. Make sure your air hose is in good condition and is long enough to reach your work without stretching.
11. **WEAR PROPER APPAREL.** Do not wear loose clothing, gloves, neckties, rings, bracelets, or other jewelry which may get caught in moving parts. Non-slip footwear is recommended. Wear a protective hair covering to contain long hair.
12. **ALWAYS USE SAFETY GLASSES.** Also use a face or dust mask if cutting operation is dusty. Everyday eyeglasses only have impact resistant lenses, they are NOT safety glasses.
13. **WEAR APPROVED HEARING PROTECTION.** Air escaping from pneumatic tools can exceed safe exposure limits and may cause hearing damage with prolonged exposure.
14. **SECURE WORK.** Use clamps or a vise to hold work when practical. It is safer than using your hand and frees both hands to operate tool.
15. **MAINTAIN TOOLS WITH CARE.** Keep tools lubricated and clean for best and safest performance. Follow instructions for lubricating and changing accessories.
16. **REDUCE THE RISK OF UNINTENTIONAL STARTING.** Do not carry tool with hand on trigger and always disconnect from air when not in use.
17. **DISCONNECT TOOLS** before servicing and changing accessories.
18. **DO NOT OVERREACH.** Keep proper footing/balance at all times.
19. **USE THE RECOMMENDED ACCESSORIES.** Consult owner's manual for recommended accessories. The use of improper accessories may cause risk of injury.
20. **CHECK FOR DAMAGED PARTS BEFORE USING.** Check for binding and alignment of parts, broken parts, part mounting, loose bolts, and any other conditions that may affect machine operation. Repair or replace damaged parts.
21. **NEVER LEAVE UNATTENDED TOOL CONNECTED TO AIR.** Disconnect the air hose and do not leave tool until it is relieved of any built up pressure.
22. **NEVER ALLOW UNTRAINED USERS TO USE THIS TOOL WHILE UNSUPERVISED.**
23. **IF YOU ARE UNSURE OF THE INTENDED OPERATION, STOP USING TOOL.** Seek formal training or research books or magazines that specialize in pneumatic tools.
24. **BE AWARE OF HOSE LOCATION WHEN USING PNEUMATIC TOOLS.** Hoses can easily become a tripping hazard when laid across the floor or spread out in a disorganized fashion.

WARNING

Additional Safety Instructions for HVLP Spray Guns

- 1. READ THIS MANUAL.** This manual contains proper operating instructions for this spray gun.
- 2. READ MATERIAL LABELS and MATERIAL SAFETY DATA SHEETS (MSDS).** Read and know all the instructions on the packaging label and the MSDS before opening the package. This information could save your life.
- 3. RESPIRATORY PROTECTION.** Always wear a NIOSH approved respirator when spraying or working around finishing materials.
- 4. FIRE EXTINGUISHERS.** Always have a fully charged multi class or class B fire extinguisher in the immediate area.
- 5. FLAMMABLE MATERIAL.** NEVER spray near open flame or where any spark could occur.
- 6. FRESH AIR.** Always provide adequate exhaust to keep area free of built up vapors, NEVER spray in an enclosed space.
- 7. DISCONNECT COMPRESSED AIR.** Always disconnect the spray gun from compressed air before cleaning, changing attachments or when performing maintenance of any kind on this tool.
- 8. PROTECTIVE CLOTHING.** Protect exposed skin from overspray by wearing a protective suit or other approved garment.
- 9. INAPPROPRIATE USE.** DO NOT point or shoot spray gun directly at yourself or another person or animals. Do not attempt to use the spray gun for any other use than it was intended.
- 10. STORAGE.** Thoroughly clean and dry spray gun before storage. Store in an approved cabinet.
- 11. SOLVENTS.** Always store solvents and shop towels soaked in solvent in approved containers.
- 12. EYE PROTECTION.** Wear eye protection whenever spraying or cleaning. Solvents and chemicals can cause serious eye injury, which could lead to blindness.
- 13. OPERATING PRESSURE.** DO NOT exceed the recommended inlet air pressure. Excessive pressure could cause the spray gun to burst or cause other internal equipment damage.
- 14. LOCAL LAWS.** Consult local authorities regarding exhaust and waste disposal requirements.

SECTION 2: INTRODUCTION

Foreword

We are proud to offer the Grizzly Model H7671/H7672 HVLP Spray Gun Set. These models are part of a growing Grizzly family of fine tools. When used according to the guidelines set forth in this manual, you can expect years of trouble-free, enjoyable operation, and proof of Grizzly's commitment to customer satisfaction.

The Model H7671/H7672 features HVLP technology, which has greater transfer efficiency than suction feed spray guns by reducing overspray, saving on material costs.

It is our pleasure to provide this manual with the Model H7671/H7672. It was written to encourage safety considerations and guide you through general operating procedures and maintenance.

The specifications, details, and photographs in this manual represent the Model H7671/H7672 as supplied when the manual was prepared. However, owing to Grizzly's policy of continuous improvement, changes may be made at any time with no obligation on the part of Grizzly.

Contact Information

We stand behind our machines. If you have any service questions, parts requests or general questions about the machine, please call or write us at the location listed below.

Grizzly Industrial, Inc.
1203 Lycoming Mall Circle
Muncy, PA 17756
Phone: (570) 546-9663
E-Mail: techsupport@grizzly.com

We want your feedback on this manual. If you can take the time, please email or write to us at the address below and tell us how we did:

Grizzly Industrial, Inc.
C/O Technical Documentation Manager
P.O. Box 2069
Bellingham, WA 98227-2069
Email: manuals@grizzly.com

**HVLP SPRAY GUN SET MODEL
H7671/H7672**

MODEL	H7671		H7672	
CUP SIZE	100ml	600ml	100ml	600ml
TYPE OF FEED	GRAVITY	GRAVITY	GRAVITY	GRAVITY
FLUID TIP	0.8MM	1.4MM	0.8mm	1.4mm
AIR CONSUMPTION	5 CFM	11 CFM	5 CFM	11 CFM
INLET AIR PRESSURE	1.5-3.5 BAR 21-51 PSI	2.0-3.5 BAR 29-51 PSI	1.5-3.5 BAR 21-50 PSI	2.0-3.5 BAR 29-51 PSI
FLUID PRESSURE	LESS THAN 10 PSI	LESS THAN 10 PSI	LESS THAN 10 PSI	LESS THAN 10 PSI
CUP MATERIAL	METAL	METAL	PLASTIC	PLASTIC
MAX. PATTERN WIDTH	190mm	230mm	190mm	230mm
BODY MATERIAL	POLISHED METAL	POLISHED METAL	POLISHED METAL	POLISHED METAL
MATERIAL USAGE	SMALL TO MEDIUM SOLIDS	MEDIUM TO HIGH SOLIDS	SMALL TO MEDIUM SOLIDS	MEDIUM TO HIGH SOLIDS
WATERBORNE MATERIAL COMPATIBLE	YES	YES	YES	YES

SECTION 3: SET UP

Inventory

Your spray gun left our warehouse in a carefully packed box. If you discover the spray gun is damaged after you have signed for delivery, *please immediately call Customer Service at (570) 546-9663 for advice.*

Save the containers and all packing materials for possible inspection by the carrier or its agent. *Otherwise, filing a freight claim can be difficult.*

After you have unpacked the carton you should find the following:

Model H7671 Inventory (Figure 1)

A. Large Spray Gun	1
B. Cup 600ml.....	1
C. Small Spray Gun.....	1
D. Cup 100ml.....	1
E. Cleaning Brushes.....	2
F. Service Wrenches.....	2
G. Filters	4
H. Regulators.....	2
I. Baffle Wrenches.....	2

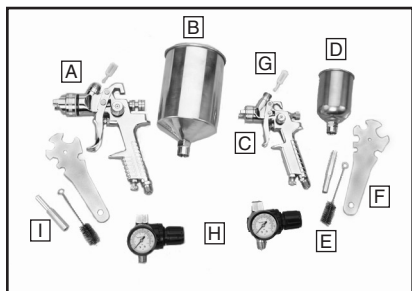

Figure 1. Model H7671 inventory.

Model H7672 Inventory (Figure 2)

A. Large Spray Gun	1
B. Cup 600ml.....	1
C. Small Spray Gun.....	1
D. Cup 100ml.....	1
E. Cleaning Brushes.....	2
F. Service Wrenches.....	2
G. Filters	4
H. Regulators.....	2
I. Baffle Wrenches.....	2

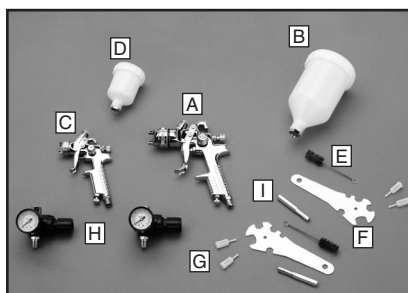

Figure 2. Model H7672 inventory.

Assembly

1. Insert the filter into the gun body (see **Figure 3**).



Figure 3. Installing filter.

2. Screw the cup onto the top of the body.
3. Attach the air hose to the spray gun with a 1/4" NPS quick connect fitting (not included).
4. Attach the spray gun to an air hose regulated between 29 and 50 PSI.

Note: For the best results, use a hose that will be dedicated for spray use only. Do not use a hose that has been used with an in-line oiler or other possible contaminant.

If you need additional help with this assembly, call our Technical Support at: (570) 546-9663.

Controls

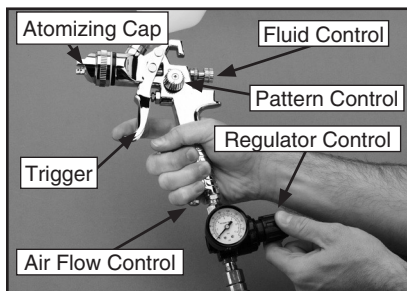

Figure 4. Controls.

1. **Fluid Control:** Controls the volume of material that travels through the fluid tip.
2. **Pattern Control:** Adjusts the spray pattern from a round pattern to a wide fan.
3. **Air Flow Control:** Controls the fluid pressure inside the spray gun (H7672 only).
4. **Atomizing Cap:** Controls the spray pattern from vertical to horizontal.
5. **Trigger:** Two stage trigger. Stage one only releases compressed air for blowing off the work piece. Stage two sprays material.
6. **Regulator/Gauge:** Regulates inlet air pressure to the spray gun. It can be attached directly to the gun for on-the-spot air adjustments or directly from the air source.

Note: DO NOT attach the regulator to an unregulated air source that exceeds 120 PSI.

SECTION 4: OPERATIONS

! DANGER



EXPLOSION HAZARD! DO NOT smoke or have any source of flame or spark near spraying. Vapors will explode if ignited.

! WARNING



RESPIRATORY HAZARD! Always use a NIOSH approved respirator when using spray equipment. Failure to protect your lungs can lead to respiratory illness and nervous system damage.

! WARNING



TOXIC FUMES! Always use an approved spray booth or well ventilated area when spraying. NEVER spray in a confined space where toxic fumes and flammable vapors can accumulate to deadly levels.

Spraying

The Model H7671/H7672 HVLP spray gun set is designed to spray a wide variety of materials like lacquers, stains, primers, multi-component paints, clear coats, acrylics, epoxies etc. It is ideal for auto body and woodworking projects.

To use your spray gun:

1. Read and follow the material manufacturer's instructions for spraying, mixing, safety, disposal, and any other instruction on the label or Material Safety Data Sheet (MSDS).
2. Ensure the cup is securely tightened and all other fittings are secure to avoid air leaks or material spills.
3. Set the inlet air pressure (the air coming to the spray gun) to the lowest pressure recommended in **Tool Data Sheet** on **Page 8** or to the material manufacturer's recommendations.
4. Adjust the atomizing cap to vertical or horizontal. See **Atomizing Cap and Fan Adjustments** on **Page 13** for further explanation.
5. Fill the cup with material.
6. Trial and error are necessary to achieve the results you want along with a fair amount of practice. Test your material flow and spray pattern on a piece of cardboard or some scrap of material similar to your project.

7. Adjust the fluid control knob to start with a low volume of material and keep the atomization as low as possible. You will need to use a combination of fluid control, inlet air pressure, air flow control and stroke speed to achieve the results you want. Spray so the material wets out nicely without running or sagging.
8. Use the pattern control knob to adjust the spray fan to your desired pattern.
9. Keep the gun tip perpendicular, parallel and 6-8" from the work at all times when spraying as shown in **Figure 5**. Do not allow your wrist to bend. This will cause the gun to arc across the surface and distribute the material unevenly, possibly creating sags and dry spots.

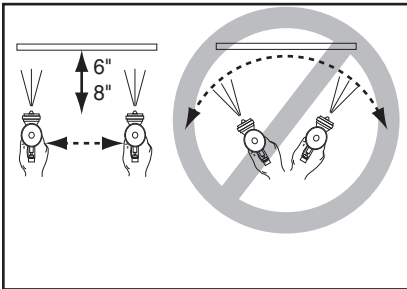

Figure 5. Spray technique.

NOTICE

Tipping spray gun may cause material to spill out of the cup. Always hold the spray gun perpendicular to the ground to avoid potential spills and gravity feed problems.

10. Begin spraying 2-3 inches before the work and continue to the end of the work. Continue the motion for a few inches past the work until you are ready for the return stroke.
11. Maintain an even speed when spraying.
12. Overlap each stroke by 50%. This will ensure even coverage as shown in **Figure 6**. Overlapping less than 50%, as shown in the figure to the right, may lead to missed spots or streaky results.

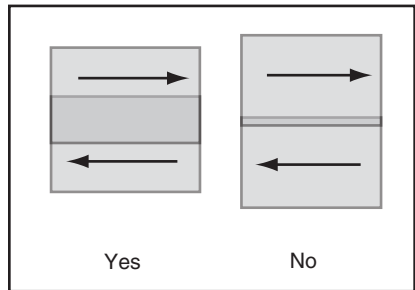

Figure 6. Overlap technique.

13. The spray stroke should have even consistency and parallel edges. If it doesn't please refer to **Troubleshooting** on **Page 17**.

CAUTION

CONTAMINATION HAZARD! Dispose of paint waste in a responsible manner! Follow manufacturer's recommendations and local laws regarding disposal.

Atomizing Cap and Fan Adjustments

The atomizing cap needs to be adjusted for horizontal or vertical spraying patterns. Spraying in the wrong direction may lead to material build up on the atomizing cap horn. Many performance problems are caused by clogged atomizing holes on the atomizing cap horns (see **Cleaning** on **Page 15**).

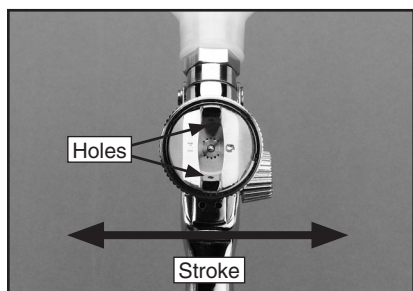

Figure 7. Set up for horizontal stroke direction with vertical fan pattern.

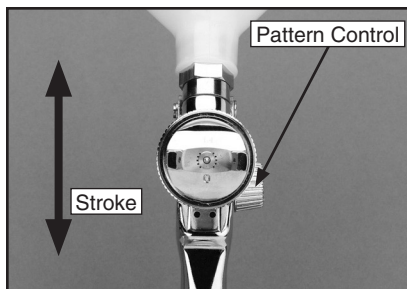

Figure 8. Set up for vertical spray stroke with horizontal fan pattern.

Rotating the pattern adjustment control in **Figure 8** will give you a range between the two patterns in **Figure 9**.

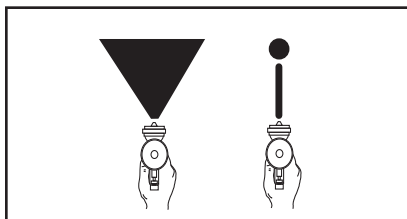

Figure 9. Fan adjustment.

SECTION 5: ACCESSORIES

G6261—Campbell Hausfeld™ Water Filter

Remove damaging water vapor before it reaches your pneumatic tools. This highly effective, five micron filter features a see-through bowl and easy in-line connections. 150 PSI maximum air pressure. ¼" NPT.



Figure 10. G6261 Campbell Hausfeld™ water filter.

G8109—¼" x 25 Ft. PVC Air Hose

G8110—¼" x 50 Ft. PVC Air Hose

H3610—¾" x 25 Ft. PVC Air Hose

Oil, kink, abrasion, ozone, and weather resistant. Rated for 300 PSI. Ends are ¼" NPT. Yellow color.



Figure 11. PVC air hose.

H7674—Spray Gun Filters – 20 Pack

Prevent solids and impurities from clogging your spray tip or ruining your finish. Designed for even paint flow, these fine mesh filters fit between the hopper and the spray gun atomizer and have 0.3 square inches of filter area.



Figure 12. H7674 Spray Gun Filters.

H3174—Air Blow Gun with 2 Tips

This air blow gun includes a safety tip and rubber tip for all normal air cleaning jobs. ¼" NPT .



Figure 13. H3174 Air Blow Gun.

Call 1-800-523-4777 To Order

SECTION 6: MAINTENANCE

Cleaning

Proper cleaning is the best way to ensure trouble free performance from your spray gun. If your gun is not thoroughly cleaned, damage and poor spraying will result. Problems caused by improper cleaning will not be covered by the warranty. Clean the spray gun immediately after each use.

To clean your spray gun:

1. Spray a small amount of solvent through the spray gun.

Note: Check with local laws regarding this practice. If you are spraying on a regular basis, spraying solvents into the air may be illegal. A cabinet style spray gun cleaner may be required.

2. **Disconnect the gun from the compressed air!**
3. Unscrew the cup.
4. Disassemble the gun by unscrewing the fluid control knob, removing the spring and needle.

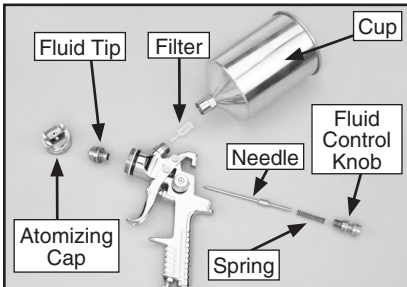

Figure 14. Disassembly for cleaning.

5. Unscrew the atomizing cap with your fingers and the fluid tip with the service wrench. The fully disassembled gun should look like **Figure 14**.
6. Rinse these parts thoroughly in solvent, then dry with compressed air or let air dry.

Note: If the small holes in the atomizing cap become blocked, soak in clean solvent. If the blockage still exists, clear the blockage with a small needle, taking great care to not enlarge or damage the hole. Damage to the hole will create a disrupted spray pattern.

7. Use the cleaning brush with solvent to clean the inner orifice and other hard to reach areas on the outside of the spray gun body.
8. Wipe the rest of the gun body with a shop towel and dry.

⚠ WARNING

EXPLOSION HAZARD! Chlorinated Solvents like 1,1,1-Trichloroethane and Methylene Chloride (methyl chloride) can chemically react with aluminum and may explode. Many parts in spray guns are made of aluminum. Read solvent label carefully before using solvent.

NOTICE

DO NOT soak the spray gun body in solvent. Prolonged exposure to solvent will rapidly deteriorate the spray gun washers and seals. Ignoring this notice will void your warranty.

Lubrication

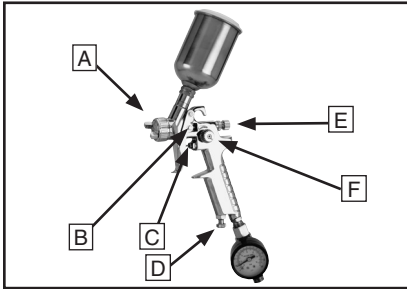







Figure 15. Lubrication points.

Lubricate the following areas with a non-silicon spray gun lubricant after cleaning.

- A.** Atomizing Cap Threads
- B.** Air Valve Packing
- C.** Trigger Pin
- D.** Air Flow Control Valve
- E.** Pattern Control
- F.** Fluid Control Knob

Allow the lubricant to coat threads, and run into gun body to lubricate all moving parts and seals.

Troubleshooting

Symptom	Possible Cause	Solution
Fluttering or spitting spray. 	<ol style="list-style-type: none"> 1. Dry or worn fluid tip seat permits air to seep into fluid passage. 2. Material level too low. 3. Fluid tip or filter obstructed. 4. Dry needle packing. 	<ol style="list-style-type: none"> 1. Tighten fluid tip or replace seat with new one. 2. Add material. 3. Clean 4. Lubricate needle.
Uneven top or bottom pattern. 	<ol style="list-style-type: none"> 1. Atomizing cap holes are obstructed. 2. Build-up on top or bottom of fluid tip. 3. Build-up on atomizing cap is on needle seat. 	<ol style="list-style-type: none"> 1. Clear holes. 2. Clean. 3. Clean.
Right or left arc pattern. 	<ol style="list-style-type: none"> 1. Left or right side horn holes are plugged. 2. Build-up on left or right side of fluid tip. 3. Build-up of material inside atomizing cap. 	<ol style="list-style-type: none"> 1. Clear holes. 2. Clean. 3. Clean.
Heavy deposit of material in center. 	<ol style="list-style-type: none"> 1. The material flow exceeds the atomizing cap capacity. 2. Inlet air pressure is too low. 3. Material is too thick. 	<ol style="list-style-type: none"> 1. Lower fluid flow. 2. Increase inlet air pressure. 3. Thin material.
Narrow center pattern. 	<ol style="list-style-type: none"> 1. Volume control turned in too far. 2. Inlet air pressure too high. 3. Fluid pressure is too low. 4. Material is too thin. 	<ol style="list-style-type: none"> 1. Increase volume. 2. Reduce inlet air pressure. 3. Increase fluid pressure. 4. Adjust material.
No spray output.	<ol style="list-style-type: none"> 1. No pressure at gun. 2. Fluid passages dirty. 3. Fluid control closed. 4. Out of paint. 5. Material too thick. 	<ol style="list-style-type: none"> 1. Check air supply. 2. Clean gun, remove any obstructions. 3. Open. 4. Refill. 5. Thin to manufacturer's recommendations.

Symptom	Possible Cause	Solution
Excessive over-spray.	<ol style="list-style-type: none"> 1. Fluid pressure too high. 2. Gun is too far from surface. 3. Spraying too fast. 	<ol style="list-style-type: none"> 1. Reduce fluid pressure. 2. Keep gun at recommended distance. 3. Slow down and maintain consistent, even parallel stroke.
Unable to control spray fan.	<ol style="list-style-type: none"> 1. Pattern adjustment screw is not seating properly. 2. Atomizing cap is loose. 	<ol style="list-style-type: none"> 1. Clean or replace. 2. Tighten atomizing cap.
Runs and sags.	<ol style="list-style-type: none"> 1. Damaged seal. 	<ol style="list-style-type: none"> 1. Replace damaged seals.
Material leaks from cup.	<ol style="list-style-type: none"> 1. Cap not secure. 2. Cup not tight on gun body. 3. Leaking from cap vent hole. 	<ol style="list-style-type: none"> 1. Tighten. 2. Tighten. 3. Hold gun upright do not tilt.
Material leaks from gun.	<ol style="list-style-type: none"> 1. Fluid tip loose. 2. Dry or damaged seals. 3. Excessive pressure. 	<ol style="list-style-type: none"> 1. Tighten. 2. Replace seals. 3. Reduce pressure.
Thick dimpled finish aka "Orange Peel."	<ol style="list-style-type: none"> 1. Holding gun too close to surface. 2. Inlet air pressure too low. 3. Material not properly mixed. 4. Surface is dirty or oily. 	<ol style="list-style-type: none"> 1. Spray at recommended distance. 2. Check inlet air pressure. 3. Follow manufacturer's instructions. 4. More surface prep is required.
Dry Spray.	<ol style="list-style-type: none"> 1. Inlet air pressure too high. 2. Gun too far from surface. 3. Gun stroke too fast. 	<ol style="list-style-type: none"> 1. Lower inlet air pressure. 2. Keep gun at recommended distance. 3. Slow down and maintain consistent even parallel stroke.
Gun leaks from fluid tip.	<ol style="list-style-type: none"> 1. Debris will not let the needle seat with the fluid tip. 	<ol style="list-style-type: none"> 1. Clean or replace both.
Contaminated paint, aka "Fish Eyes.	<ol style="list-style-type: none"> 1. Water or oil in the air line. 	<ol style="list-style-type: none"> 1. Install an in-line air filter. 2. Replace air line.

Parts List H7671/H7672

REF PART #	DESCRIPTION
1	PH7671001 FLUID ADJUSTMENT SCREW
2	PH7671002 FLUID ADJUSTMENT KNOB
3	PH7671003 O-RING
4	PH7671004 SPECIAL WASHER
5	PH7671005 AIR VALVE SPRING
6	PH7671006 AIR INLET VALVE
7	PH7671007 SWITCH SPRING
8	PH7671008 AIR INLET VALVE ASSY
9	PH7671009 SWITCH KNOB
10	PH7671010 SWITCH WASHER
11	PH7671011 LOCK SCREW
12	PH7671012 CAP NUT
13	PH7671013 AIR CAP WASHER
14	PH7671014 ATOMIZATION CAP
15	PH7671015 NUT HOUSING
16	PH7671016 FLUID NOZZLE 0.8MM
17	PH7671017 FLUID NOZZLE WASHER
18	PH7671018 NOZZLE BOLT
19	PH7671019 NEEDLE WASHER
20	PH7671020 COMPRESSED SPRING
21	PH7671021 TRIGGER LEVER 1
22	PH7671022 TRIGGER LEVER 2
23	PH7671023 TRIGGER
24	PH7671024 SNAP RETAINER
25	PH7671025 SNAP RETAINER
26	PH7671026 CONTAINER COVER
26	PH7671026 CONTAINER COVER
27	PH7671027 CUP 100ML
27	PH7671027 CUP 100ML
28	PH7671028 FILTER
29	PH7671029 FLUID INLET JOINT
30	PH7671030 FLUID NEEDLE
31	PH7671031 FLUID NEEDLE SPRING
32	PH7671032 LOCK RING
33	PH7671033 PAINT ADJ KNOB
34	PH7671034 KNOB SCREW
35	PH7671035 PATTERN ADJ KNOB
36	PH7671036 PATTERN ADJ SCREW
37	PH7671037 O-RING
38	PH7671038 O-RING
39	PH7671039 SNAP RETAINER
40	PH7671040 PATTERN ADJ NUT
41	PH7671041 O-RING
42	PH7671042 AIR INLET JOINT
43	PH7671043 SERVICE WRENCH
44	PH7671044 CLEANING BRUSH
45	PH7671045 AIR REGULATOR
46	PH7671046 AIR ADJUSTMENT SCREW
47	PH7671047 AIR ADJUSTMENT KNOB
48	PH7671048 O-RING

REF PART #	DESCRIPTION
49	PH7671049 SPECIAL WASHER
50	PH7671050 AIR VALVE SPRING
51	PH7671051 AIR INLET VALVE
52	PH7671052 SWITCH SPRING
53	PH7671053 AIR VALVE BODY
54	PH7671054 SWITCH KNOB
55	PH7671055 O-RING
56	PH7671056 SPECIAL WASHER
57	PH7671057 DIRECTION SCREW
58	PH7671058 PIN SPRING
59	PH7671059 CAP NUT
60	PH7671060 FLUID CAP WASHER
61	PH7671061 ATOMIZATION CAP
62	PH7671062 FLUID NOZZLE 1.4MM
63	PH7671063 BAFFLE
64	PH7671064 BAFFLE WASHER
65	PH7671065 DIRECTION SCREW
66	PH7671066 PAINT NEEDLE WASHER
67	PH7671067 LOCKING SPRING
68	PH7671068 TRIGGER LEVER 1
69	PH7671069 TRIGGER LEVER 2
70	PH7671070 TRIGGER
71	PH7671071 SNAP RETAINER
72	PH7671072 SNAP RETAINER
73	PH7671073 VENTILATOR HEAD
74	PH7671074 CUP COVER
74	PH7671074 CUP COVER
75	PH7671075 CUP 600ML
75	PH7671075 CUP 600ML
76	PH7671076 FILTER
77	PH7671077 INLET WASHER
78	PH7671078 FLUID INLET JOINT
79	PH7671079 HOOK
80	PH7671080 FLUID ADJ NEEDLE
81	PH7671081 FLUID NEEDLE SPRING
82	PH7671082 LOCK NUT
83	PH7671083 FLUID ADJ KNOB
84	PH7671084 KNOB SCR
85	PH7671085 PATTERN ADJ
86	PH7671086 PATTERN ADJ KNOB
87	PH7671087 SPECIAL WASHER
88	PH7671088 PATTERN ADJ SCREW
89	PH7671089 O-RING
90	PH7671090 SNAP RETAINER
91	PH7671091 AIR INLET JOINT
92	PH7671092 SERVICE WRENCH
93	PH7671093 BAFFLE WRENCH
94	PH7671094 SMALL GUN BODY
95	PH7671095 LARGE GUN BODY

WARRANTY AND RETURNS

Grizzly Industrial, Inc. warrants every product it sells for a period of **1 year** to the original purchaser from the date of purchase. This warranty does not apply to defects due directly or indirectly to misuse, abuse, negligence, accidents, repairs or alterations or lack of maintenance. This is Grizzly's sole written warranty and any and all warranties that may be implied by law, including any merchantability or fitness, for any particular purpose, are hereby limited to the duration of this written warranty. We do not warrant or represent that the merchandise complies with the provisions of any law or acts unless the manufacturer so warrants. In no event shall Grizzly's liability under this warranty exceed the purchase price paid for the product and any legal actions brought against Grizzly shall be tried in the State of Washington, County of Whatcom.

We shall in no event be liable for death, injuries to persons or property or for incidental, contingent, special, or consequential damages arising from the use of our products.

To take advantage of this warranty, contact us by mail or phone and give us all the details. We will then issue you a "Return Number," which must be clearly posted on the outside as well as the inside of the carton. We will not accept any item back without this number. Proof of purchase must accompany the merchandise.

The manufacturers reserve the right to change specifications at any time because they constantly strive to achieve better quality equipment. We make every effort to ensure that our products meet high quality and durability standards and we hope you never need to use this warranty.

Please feel free to write or call us if you have any questions about the machine or the manual.

Thank you again for your business and continued support. We hope to serve you again soon.

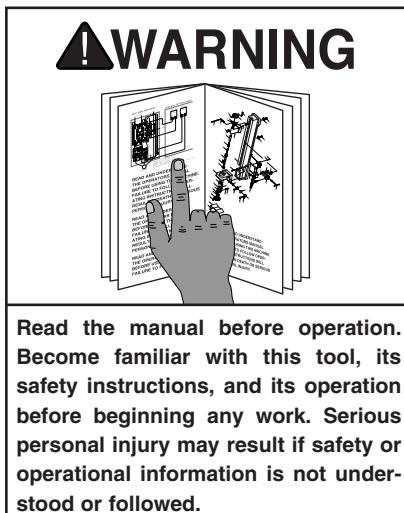

Free Manuals Download Website

<http://myh66.com>

<http://usermanuals.us>

<http://www.somanuals.com>

<http://www.4manuals.cc>

<http://www.manual-lib.com>

<http://www.404manual.com>

<http://www.luxmanual.com>

<http://aubethermostatmanual.com>

Golf course search by state

<http://golfingnear.com>

Email search by domain

<http://emailbydomain.com>

Auto manuals search

<http://auto.somanuals.com>

TV manuals search

<http://tv.somanuals.com>