



MODEL T10048 COLLET/TOOLING CART FOR NT40 INSTRUCTIONS



Figure 1. Model T10048 collet/tooling cart.



Figure 2. Example of use.

Introduction

The Model T10048 is a specialized cart to keep your NT40 collets and tooling organized, protected, and close at hand. The top and middle shelves hold a total of 48 collets with additional space for storing tooling on the lower and two end shelves. Collet holders are non-marring and can be marked for quick identification—ideal for CNC machines. The heavy-duty rubber casters provide easy movement of the cart and can lock the cart in place.

Specifications

Number of Collet Holders 48
Overall Dimensions 39"L x 18¼"W x 34⅞"H
End Shelf Dimensions 18"W x 9¾"L
Weight 70 lbs.

If you need help with your new item, call our Tech Support at: (570) 546-9663.

!WARNING

This cart is designed to ONLY hold metal-working collets and tooling. DO NOT stand or sit on any part of this cart. DO NOT use or modify this cart for any other purpose than what it was designed for. Failure to heed these instructions could lead to serious personal injury or property damage.

COPYRIGHT © APRIL, 2008 BY GRIZZLY INDUSTRIAL, INC.

WARNING: NO PORTION OF THIS MANUAL MAY BE REPRODUCED IN ANY SHAPE OR FORM WITHOUT THE WRITTEN APPROVAL OF GRIZZLY INDUSTRIAL, INC.

#TS10611 PRINTED IN CHINA

Inventory

Use the following chart and **Figures 3–5** to identify and inventory the items included with your shipment.

REF	PART #	DESCRIPTION	QTY
1	PT10048001	TOP SHELF	1
2	PT10048002	MIDDLE SHELF	1
3	PT10048003	COLLET HOLDER	48
4	PT10048004	BOTTOM SHELF	1
5	PT10048005	SIDE PANEL	2
6	PT10048006	SIDE SHELF	2
7	PT10048007	SIDE SHELF SUPPORT	4
8	PT10048008	FIXED CASTER 5"	2
9	PT10048009	SWIVEL/LOCK CASTER 5"	2
10	PT10048010	HANDLE	1
11	PB02M	HEX BOLT M6-1 X 12	70
12	PLN03M	LOCK NUT M6-1	70
13	PWR810	COMBO WRENCH 8/10MM	1

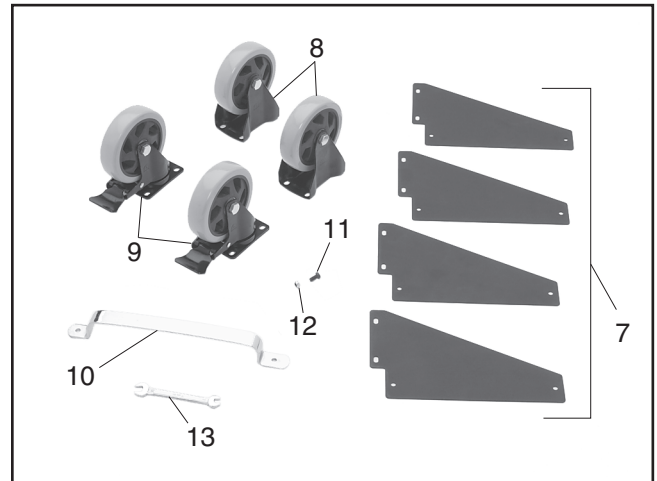

Figure 5. Model T10048 inventory (3).

Assembly

Only hand tighten the hex bolts and lock nuts until the assembly is complete, except where otherwise instructed. Also, refer to the photographs for orientation of the items one to another for correct assembly.

To assemble the cart:

1. Lay the bottom shelf on a flat, stable working surface.
2. Install the side panels inside the flanges of the bottom shelf, as shown in **Figure 6**, using six hex bolts and lock nuts for each side.

Note: Make sure the middle shelf mounting flanges on the side panels are pointing up, as shown in **Figure 6**.

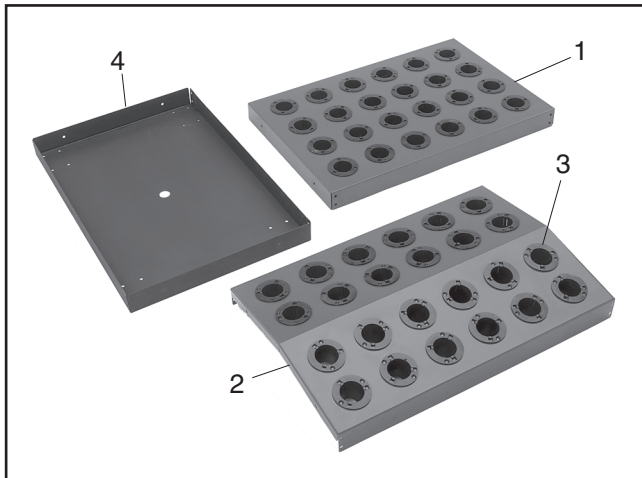

Figure 3. Model T10048 inventory (1).

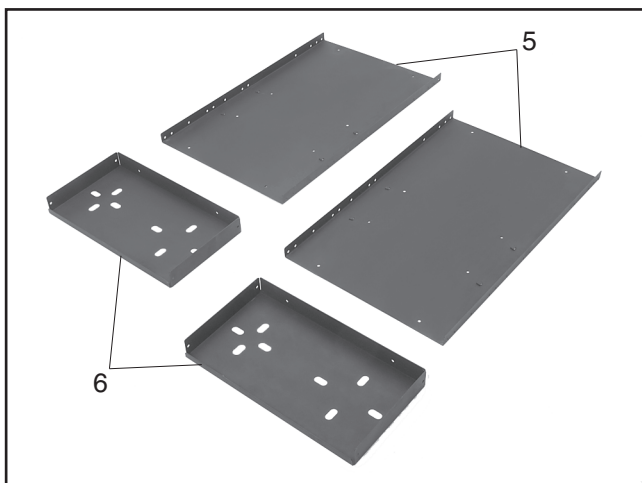

Figure 4. Model T10048 inventory (2).



Figure 6. Side panel installed onto the bottom shelf.



- Slide the middle shelf onto the mounting flanges of the side panels and secure it in place with 12 hex bolts and lock nuts, as shown in **Figure 7**.

Note: There are two possible mounting positions for the middle shelf, as shown in **Figure 6**.

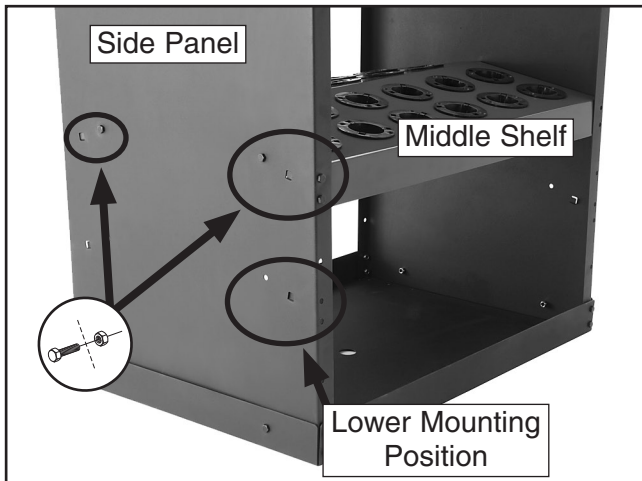

Figure 7. Middle shelf installed onto the side panels.

- Slide the top shelf over the top of the side panels, position the handle on one side, as shown in **Figure 8**, then secure the top shelf and handle in place with 12 hex bolts and lock nuts.

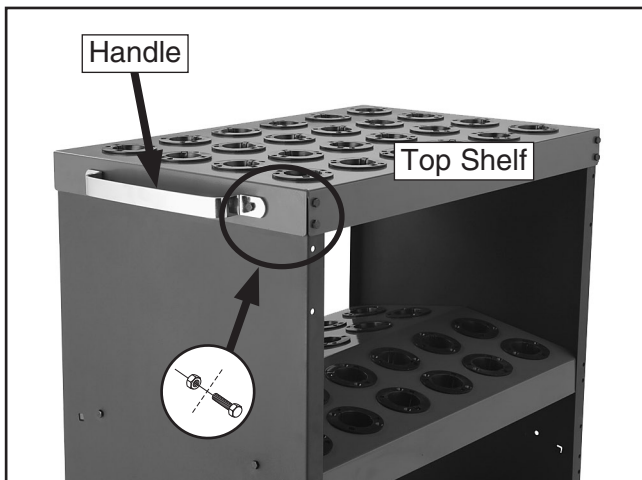

Figure 8. Top shelf and handle installed.

- Attach the side shelf supports to the side shelves with 8 hex bolts and lock nuts, as shown in **Figure 9**. Fully tighten these fasteners.

Note: Take special note of the orientation of the shelf and supports to one another.

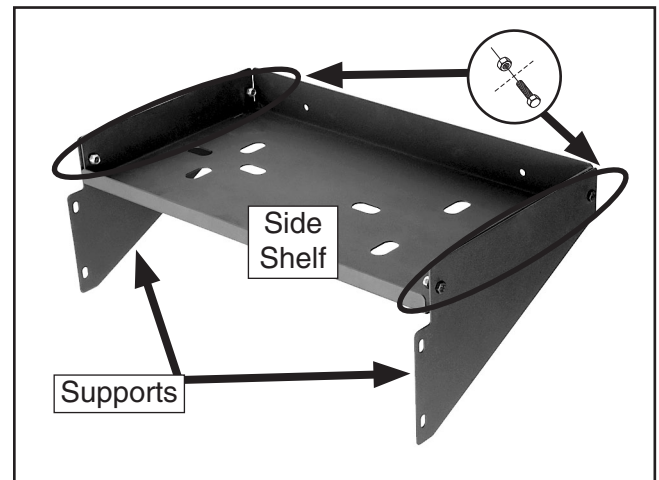

Figure 9. Side shelf supports installed.

- Attach the side shelf assemblies to the side of the cart opposite the handle with 8 hex bolts and lock nuts, as shown in **Figure 10**. Fully tighten these fasteners.

Note: There are two possible mounting positions for the bottom side shelf assembly.



Figure 10. Side shelf assemblies installed.



7. Square up the sides of the cart with the top and middle shelves, then fully tighten all fasteners.
8. With assistance, turn the cart upside down and install the casters with 16 hex bolts and lock nuts, as shown in **Figure 11**.
9. With assistance, tip the cart upright, then check for stability and use. If necessary, loosen fasteners, readjust the panels and shelves, then re-tighten the fasteners.

Note: To better move the cart, we recommend installing the swivel casters on the same side as the handle.

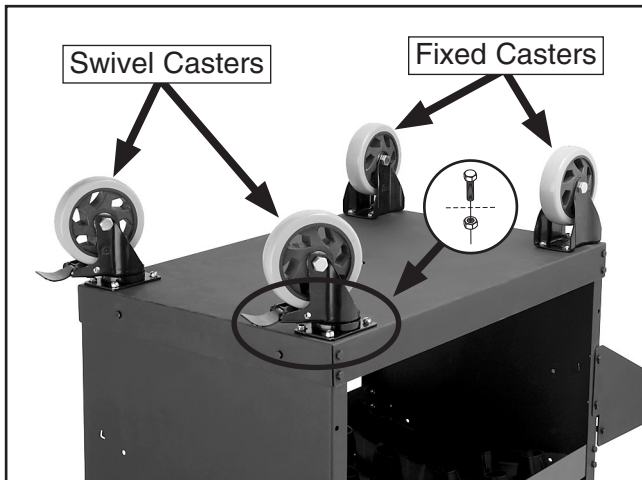

Figure 11. Casters installed.



Free Manuals Download Website

<http://myh66.com>

<http://usermanuals.us>

<http://www.somanuals.com>

<http://www.4manuals.cc>

<http://www.manual-lib.com>

<http://www.404manual.com>

<http://www.luxmanual.com>

<http://aubethermostatmanual.com>

Golf course search by state

<http://golfingnear.com>

Email search by domain

<http://emailbydomain.com>

Auto manuals search

<http://auto.somanuals.com>

TV manuals search

<http://tv.somanuals.com>