

# *Grizzly* **Industrial, Inc.**®

## MODEL H7949/H7950/H7951 INSTRUCTION MANUAL



**H7949 2 1/2"  
COIL NAILER**



**H7950 2 3/4"  
COIL NAILER**



**H7951  
ROOFING NAILER**

COPYRIGHT © DECEMBER, 2006 BY GRIZZLY INDUSTRIAL, INC.  
WARNING: NO PORTION OF THIS MANUAL MAY BE REPRODUCED IN ANY SHAPE  
OR FORM WITHOUT THE WRITTEN APPROVAL OF GRIZZLY INDUSTRIAL, INC.

#JC8623 PRINTED IN TAIWAN

# SAFETY

## **WARNING**

### **For Your Own Safety Read Instruction Manual Before Operating This Equipment**

The purpose of safety symbols is to attract your attention to possible hazardous conditions. This manual uses a series of symbols and signal words which are intended to convey the level of importance of the safety messages. The progression of symbols is described below. Remember that safety messages by themselves do not eliminate danger and are not a substitute for proper accident prevention measures.

#### **DANGER**

Indicates an imminently hazardous situation which, if not avoided, WILL result in death or serious injury.

#### **WARNING**

Indicates a potentially hazardous situation which, if not avoided, COULD result in death or serious injury.

#### **CAUTION**

Indicates a potentially hazardous situation which, if not avoided, MAY result in minor or moderate injury. It may also be used to alert against unsafe practices.

#### **NOTICE**

This symbol is used to alert the user to useful information about proper operation of the equipment.

## **WARNING**

### **Safety Instructions For Pneumatic Tools**

- KEEP ALL SAFETY DEVICES IN PLACE** and in working order.
- REMOVE ADJUSTING KEYS AND WRENCHES.** Form habit of checking to see that keys and adjusting wrenches are removed from tool before operation.
- KEEP WORK AREA CLEAN.** Cluttered areas and benches invite accidents.
- DO NOT USE IN DANGEROUS ENVIRONMENT.** Do not use pneumatic tools in damp or wet locations, or where any flammable or noxious fumes may exist. Keep work area well lighted.
- KEEP CHILDREN AND VISITORS AWAY.** All children and visitors should be kept at a safe distance from work area.
- MAKE WORKSHOP CHILD PROOF** by locking your shop and shutting off air valves.
- DO NOT FORCE TOOL.** It will do the job better and safer at the rate for which it was designed.
- USE THE RIGHT TOOL.** Do not force tool or attachment to do a job for which it was not designed.
- DO NOT USE UNDER THE INFLUENCE OF DRUGS OR ALCOHOL.**

# WARNING

## Safety Instructions For Pneumatic Tools

10. **USE PROPER AIR HOSE** for the tool. Make sure your air hose is in good condition and is long enough to reach your work without stretching.
11. **WEAR PROPER APPAREL.** Do not wear loose clothing, gloves, neckties, rings, bracelets, or other jewelry which may get caught in moving parts. Non-slip footwear is recommended. Wear a protective hair covering to contain long hair.
12. **ALWAYS USE ANSI APPROVED SAFETY GLASSES.** Also use a face or dust mask if cutting operation is dusty. Everyday eyeglasses only have impact resistant lenses, they are NOT safety glasses.
13. **ALWAYS WEAR ANSI APPROVED HEARING PROTECTION.**
14. **SECURE WORK.** Use clamps or a vise to hold work when practical. It is safer than using your hand and frees both hands to operate tool.
15. **MAINTAIN TOOLS WITH CARE.** Keep tools lubricated and clean for best and safest performance. Follow instructions for lubricating and changing accessories.
16. **REDUCE THE RISK OF UNINTENTIONAL STARTING.** Do not carry tool with hand on trigger and always disconnect from air when not in use.
17. **DISCONNECT TOOLS** before servicing, changing accessories, or moving to another location.
18. **DO NOT OVERREACH.** Keep proper footing and balance at all times.
19. **USE THE RECOMMENDED ACCESSORIES.** Consult owner's manual for recommended accessories. The use of improper accessories may cause risk of injury.
20. **CHECK FOR DAMAGED PARTS BEFORE USING.** Check for binding and alignment of parts, broken parts, part mounting, loose bolts, and any other conditions that may affect machine operation. Repair or replace damaged parts.
21. **NEVER LEAVE UNATTENDED TOOL CONNECTED TO AIR.** Disconnect the air hose and do not leave tool until it is relieved of any built up pressure.
22. **NEVER ALLOW UNTRAINED USERS TO USE THIS TOOL WHILE UNSUPERVISED.**
23. **IF YOU ARE UNSURE OF THE INTENDED OPERATION, STOP USING THE TOOL.** Seek formal training or research books or magazines that specialize in pneumatic tools.

# WARNING

## Additional Safety Instructions for Nailers

- 1. HAND INJURIES:** Do not place your hands near the nail point of entry. A nail can deflect and tear through the surface of the workpiece, puncturing your hand or fingers.
- 2. COMBUSTIBLE GASES:** Never connect the nailer to pressurized oxygen or other combustible gases as a power source. Only use filtered, lubricated, and regulated compressed air.
- 3. SAFE HANDLING:** Never point the nailer at others! Do not keep the trigger pulled when loading fasteners, carrying, or holding tool. Carry the nailer only by the handle, never by any other part. Do not carry the nailer by the air hose. Disconnect the nailer from the air hose when going up and down ladders.
- 4. AIR HOSE:** Make sure your air hose is designed for the tool in use, is in good condition, and is long enough to reach your work without stretching. However, an overly long air hose in the work area may be a tripping hazard.
- 5. COMPRESSED AIR RATING:** Do not connect the nailer to compressed air that exceeds 120 PSI.
- 6. CHECK VALVE:** Do not use a check valve or any other fitting that allows air to remain in the tool.
- 7. CLEANING:** Never use gasoline or other flammable liquids to clean the nailer; vapors in the nailer may ignite by a spark and cause the nailer to explode.
- 8. OPERATING QUESTIONS:** If you are not sure about the intended operation, stop using the nailer. Seek formal training or research sources that specialize in pneumatic tools.
- 9. MAINTENANCE:** Always disconnect air from the nailer when servicing or installing nails. During adjustments or maintenance, a nailer connected to air may fire accidentally, causing serious personal injury.



# INTRODUCTION

---

---

## Foreword

---

---

We are proud to offer the Grizzly Model H7949/H7950/H7951 Nailer. This nailer is part of a growing Grizzly family of fine pneumatic tools. When used according to the guidelines in this manual, you can expect years of trouble-free, enjoyable operation and proof of Grizzly's commitment to customer satisfaction.

The specifications and photographs in this manual represent Model H7949/H7950/H7951 as supplied when this manual was prepared. However, owing to Grizzly's policy of continuous improvement, changes may be made at any time with no obligation on the part of Grizzly.

## Model H7949 Specifications

---

---

Nail Type .....Flat Wire Welded Coil  
Nail Length ..... 1 1/2"-2 1/2"  
Magazine Capacity ..... 250-400 Nails  
Weight ..... 5.5 lbs.  
Air Inlet ..... 1/4" NPT.  
Operating Pressure ..... 70-110 PSI

## Model H7950 Specifications

---

---

Nail Type .....Flat Wire Welded Coil  
Nail Length ..... 1 1/2"-2 3/4"  
Magazine Capacity ..... 250-400 Nails  
Weight ..... 6.2 lbs.  
Air Inlet ..... 1/4" NPT.  
Operating Pressure ..... 70-110 PSI

## Model H7951 Specifications

---

---

Nail Type .....Flat Wire Welded Coil  
Nail Length ..... 3/4"-1 3/4"  
Magazine Capacity ..... 250-400 Nails  
Weight ..... 5.5 lbs.  
Air Inlet ..... 1/4" NPT.  
Operating Pressure ..... 70-110 PSI

## Contact Info

---

---

If you have any comments regarding this manual, please write to us at the following address:

Grizzly Industrial, Inc.  
C/O Technical Documentation Manager  
P.O. Box 2069  
Bellingham, WA 98227-2069  
Email: manuals@grizzly.com

Most importantly, we stand behind our tools. If you have any service questions or parts requests, please call or write us at the location listed below.

Grizzly Industrial, Inc.  
1203 Lycoming Mall Circle  
Muncy, PA 17756  
Phone: (570) 546-9663  
Fax: (800) 438-5901  
E-Mail: techsupport@grizzly.com  
Web Site: <http://www.grizzly.com>

# SETUP

## Unpacking

Your Model H7949/H7950/H7951 left our warehouse in a carefully packed box. If you discover the nailer is damaged after you have signed for delivery, *please immediately call Customer Service at (570) 546-9663 for advice.*

Save the containers and all packing materials for possible inspection by the carrier or its agent. *Otherwise, filing a freight claim can be difficult.*

When you are completely satisfied with the condition of the shipment, you should inventory the equipment.

## Inventory

After you open the nailer box, you should find the following.

### Model H7949/H7950/H7951 Inventory (Figure 1)

- A. Nailer..... 1
- B. Nailer Case ..... 1
- C. O-Rings..... 2
- D. Pneumatic Tool Oil ..... 1
- E. Hex Wrenches 4, 5mm ..... 1 Each
- F. Interchangeable Nose Tips (not shown) ..... 3



Figure 1. Model H7949/H7950/H7951 inventory.

## Compressed Air System

The Model H7949/H7950/H7951 is designed to be operated at 70–110 PSI using clean, dry, regulated, compressed air. DO NOT exceed 120 PSI.

Before using your new nailer, set the air pressure on your regulator to the minimum PSI for your model.

An in-line filter/lubricator/regulator unit, depicted in **Figure 2**, can be installed and should be located as close to the nailer as possible.

This filter/lubricator/regulator unit will protect your tool from damaging water build-up, allow you to adjust and maintain constant air pressure to your tool, and save you the inconvenience of manually lubricating your tool every time you use it.

Check the current Grizzly catalog for availability of this unit. If you plan on installing a filter/lubricator/regulator unit in your compressed air system, always follow the connection instructions that come with the unit.

### **⚠ WARNING**

**Exceeding the maximum permissible operating pressure may damage the seals, gaskets and hammer mechanism of your nailer. DO NOT allow your air compressor to exceed the recommended pressure when connected to this nailer or serious personal injury may result!**

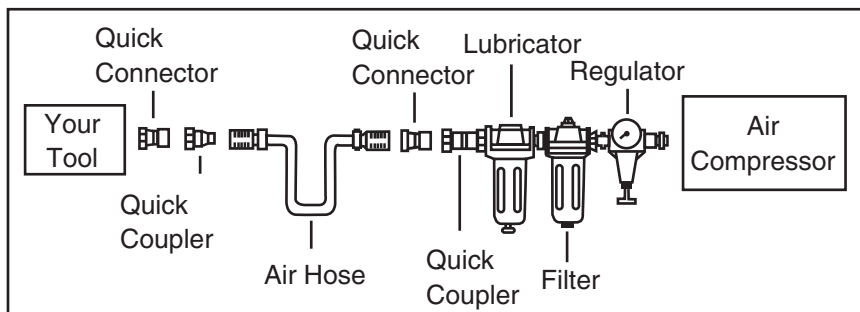

**Figure 2.** Typical filter/lubricator/regulator installation order.



# Testing Safety Nose Mechanism

A safety mechanism (bump fire) on the nose of the nailer protects against accidental firing. This mechanism is activated when nails are loaded into the magazine. The nailer will not fire when the trigger is pulled until the safety nose is fully depressed.

Before you use your nailer for the first time, check the safety nose mechanism to ensure proper function.

## **WARNING**

**The safety mechanism is a mechanical device that can fail. Never rely on this mechanism as an excuse to point the nailer at yourself or any bystanders. Serious injury may occur.**

**To verify that the safety nose is working correctly:**

1. DISCONNECT NAILER FROM THE AIR SUPPLY!
2. Insert a coil of nails in the magazine (see **Page 8** for instructions).
3. Make sure the trigger and the safety nose mechanism move up and down without sticking.
4. Connect the nailer to the air supply.

## **WARNING**

**Point the nailer away from you and others when connecting the air supply. The nailer can cycle and discharge a nail when the air supply is connected. Ignoring this warning may result in serious personal injury.**

5. Without pressing the trigger, depress the safety nose mechanism against a scrap piece of wood that is clean and free of any knots, nails, or other foreign objects.

— If the nailer does not fire, then the safety nose mechanism is working correctly.

— If the nailer does fire when you depress the safety nose, immediately disconnect the nailer from the air supply and call Grizzly Technical Support at (570) 546-9663 for help.

6. Without depressing the safety nose, point the nailer in a safe direction, and pull the trigger.

— If the nailer does not fire, then the safety nose mechanism is working correctly.

— If the nailer does fire when the trigger is pulled, without the safety nose mechanism being depressed, immediately disconnect the nailer from the air supply and call Grizzly Technical Support at (570) 546-9663 for help.

# OPERATIONS

## Model H7949/H7950 Loading Nails

Use nails meeting the specifications listed for your nailer on **Page 4** of this manual.

To load nails in your nailer:

1. DISCONNECT NAILER FROM THE AIR SUPPLY!

### **⚠️ WARNING**

Point the nailer away from you and others when connecting the air supply. The nailer can cycle and discharge a nail when the air supply is connected. Ignoring this warning may result in serious personal injury.

2. Pull the magazine open from the cover tab as shown in **Figure 3**.



**Figure 3.** Opening the magazine: Model H7949/H7950.

3. Press the adjusting pin inside the magazine and slide the plate up or down until the plate position matches the nail length as shown in **Figure 4**.

**Note:** The plate must be set at the proper height or the nails will not feed smoothly into firing position.

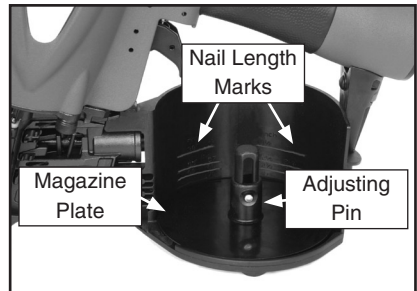

**Figure 4.** Positioning the magazine plate.

4. Place the nail coil into the magazine and uncoil enough nails to reach the driving hole as shown in **Figure 5**.

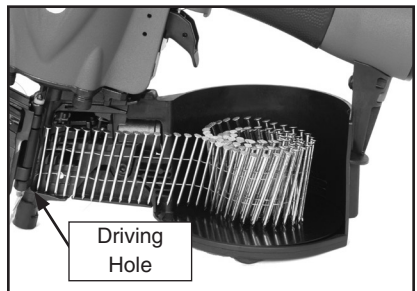

**Figure 5.** Loading nails in the magazine.

- Put the first nail into the driving hole and the second nail between the two pawls of the feeder as shown in **Figure 6**.

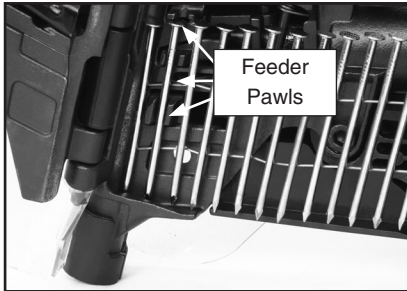

**Figure 6.** Putting the nails in firing position.

- Close and latch the magazine cover.

---



---

## Model H7951 Loading Nails

---



---

Use nails meeting the specifications listed for your nailer on **Page 4** of this manual.

### To load nails in your nailer:

- DISCONNECT NAILER FROM THE AIR SUPPLY!

## ⚠ WARNING

Point the nailer away from you and others when connecting the air supply. The nailer can cycle and discharge a nail when the air supply is connected. Ignoring this warning may result in serious personal injury.

- Unlatch the cover lock, as shown in **Figure 7**, and pull the magazine cover open.

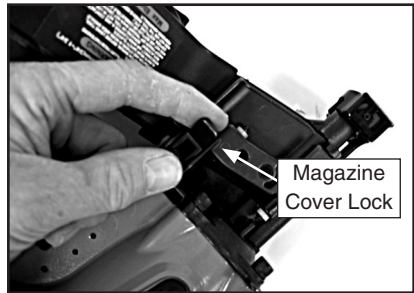

**Figure 7.** Unlatching the magazine cover lock: Model H7951.

- Press the adjusting pin inside the magazine and slide the plate up or down until the plate position matches the nail length (Figure 8).

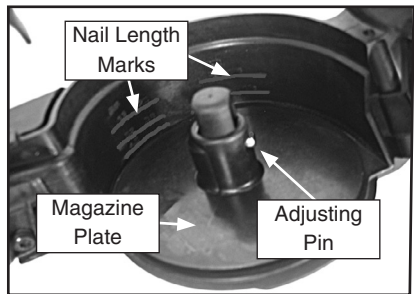

**Figure 8.** Positioning the magazine plate.

- Place a coil of nails in the magazine, position the first nail in the pawls of the feeder as shown in **Figure 9**, then close and latch the magazine cover.

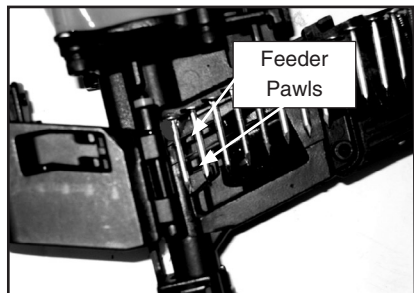

**Figure 9.** Putting the nails in firing position.

- Close and latch the magazine cover.

## Unloading Nails

---

---

### To remove unused nails:

1. DISCONNECT NAILER FROM THE AIR SUPPLY!
2. Point the nailer away from you and all bystanders.
3. Open the magazine cover (as shown on **Page 8**) and lift the nails from magazine.
4. Close the magazine cover to keep the magazine assembly clean until the nailer is reloaded.

## Rotating Exhaust Cover

---

---

The exhaust cover rotates as needed to direct the exhaust away from you.

### To rotate the exhaust cover:

1. Use the 4mm hex wrench to loosen the exhaust cover cap screw as shown in **Figure 10**.

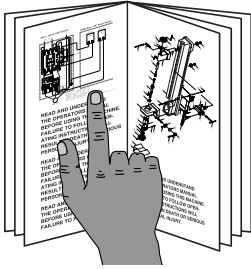

**Figure 10.** Loosening the exhaust cap screw.

2. Rotate the exhaust cover by hand to aim the exhaust port in the desired direction.
3. Tighten the exhaust cover cap screw.

# Using the Nailer

## **! WARNING**



**Read the manual before operation. Become familiar with these nailers, their safety instructions, and operation before beginning any work. Serious personal injury may result if safety or operational information is not understood or followed.**

Before you operate your nailer, place five to six drops of air tool oil into the quick connect fitting where the nailer connects to the air supply.

### To operate your nailer:

1. Connect the air supply to the quick connect fitting on your nailer.
2. To test for proper nail penetration, hold the nailer perpendicular to the surface of a piece of clean scrap wood that is thick enough for the length of nails you have loaded.
3. Depress the safety nose mechanism against your workpiece.

4. Before pulling the trigger, make sure your free hand and other body parts are positioned out of the way of a potential path of a nail in case of deflection (illustrated below in **Figure 11**).

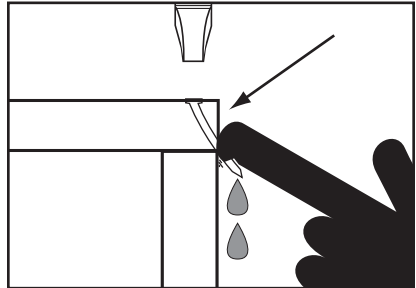

**Figure 11.** Example of nail deflection.

**Note:** Deflection is caused when grain irregularities, knots or foreign objects inside the wood cause the nail to change its path, resulting in the nail puncturing the surface of the workpiece.

Besides damaging your workpiece, deflection can cause injury if your free hand is securing the workpiece in the location that the nail deflects.

5. Pull the trigger.
  - If the nail penetrates the wood to the depth you want, continue with your intended operations.
  - If the nail either went too far or not far enough, adjust the depth of fire by following the procedures listed on **Page 12**.

## Adjusting Depth

### To adjust the nail depth:

Adjusting the depth of nail penetration is done by turning the adjustment knob located near the trigger as shown in **Figure 12**.

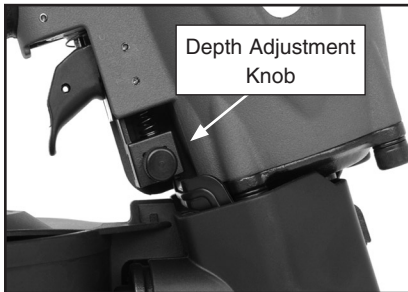

**Figure 12.** Depth adjustment knob.

1. DISCONNECT NAILER FROM THE AIR SUPPLY!
2. Turn the depth adjustment knob to increase or decrease nail penetration:
  - If you want to increase the nail depth, then turn the adjusting knob counterclockwise.
  - If you want to decrease the nail depth, then turn the adjusting knob clockwise.
3. Connect the nailer to the air supply, test the nail depth, and repeat this entire procedure if necessary until the nail depth is satisfactory.

## Clearing Jammed Nails

A jammed nail must be cleared before the nailer is used again.

### To clear a jammed nail from the discharge area:

1. DISCONNECT NAILER FROM THE AIR SUPPLY!
2. Remove all nails from the magazine.
3. Use a steel rod and hammer to tap the jammed nail back into the magazine driving hole as shown in **Figure 13**.

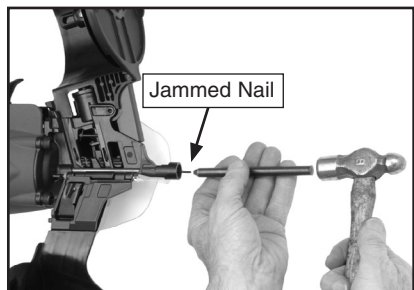

**Figure 13.** Tapping a jammed nail back into the magazine driving hole.

4. Use a screwdriver to pry the jammed nail out of the driving hole as shown in **Figure 14**.



**Figure 14.** Prying a jammed nail from the driving hole.

# Replacing Pistons/O-Rings

If you need to replace piston parts in your nailer, you can purchase a piston repair kit from Grizzly; call 1-800-523-4777.

The Piston Repair Kit part number for Model H7949 is PH7949103; the Piston Repair Kit part number for Model H7950 is PH7950103; the Piston Repair Kit part number for Model H7951 is PH7951104.

Refer to the parts breakdown during this procedure to identify parts and their locations inside the nailer.



## To replace a piston and O-ring(s):

1. DISCONNECT NAILER FROM THE AIR SUPPLY!
2. Remove all nails from the magazine.
3. Remove the four screws that secure the nailer cap and remove the cylinder cap.

4. Push the top of the piston down with your finger as far as it will go; this will push the piston driver into the nose of the nailer.
5. Insert a stiff rod or wire of the same diameter as your nails into the discharge area of the nose and use it to push the piston driver up until the piston head clears the top of the cylinder. (Be careful not to scratch the discharge area or the piston cylinder.)
6. Grip the piston head by hand and remove the piston assembly from the cylinder.
7. Clean all metal parts with an automotive grade solvent. Clear all ports and blow the solvent away with compressed air.
8. Replace any part that shows damage of heavy wear. Relubricate the tool.
9. Apply a thin film of the nailer lubricating oil on the new O-ring and place it on the new piston. Install any other parts included in the piston repair kit.
10. Insert the new piston in the cylinder. With the magazine cover open, gently push the piston down to make sure the piston driver moves freely into the driving hole.

**Note:** *DO NOT force the piston into the cylinder! If the piston 'hangs' in the cylinder, double check the fit between piston and O-ring and make sure the cylinder is clean.*

11. Make sure that the cap gasket is in place, then secure the cap to the nailer body by tightening the 4 cap screws.

# CLEANING & LUBRICATING

## Cleaning

Use an automotive grade solvent such as Sprayway C-60® (G2544 in the Grizzly catalog) to clean the nose assembly of the nailer. Always be sure that the nailer is dry before using it again.

Do not allow dust, chips, or sand into the air connectors or into the body of the nailer; this may result in leaks and damage to the nailer and the air couplings.



**Never use gasoline to clean this tool. Use extreme caution when using any solvent cleaner. Always clean the tool in a well-ventilated area and never if sparks or open flames are present. Remember that electrical machinery can produce sparks during normal operation. Ignoring this warning can cause serious personal injury or even death!**

## Lubricating

Special pneumatic tool oil has been included with your new Grizzly nailer to help maintain its useful life. Place two to six drops of oil in the nailer air inlet (as shown in **Figure 15**) every 2 hours of continuous use.

Wipe off any excess oil near the nailer exhaust to avoid dust build-up. When the oil that was included with your nailer has been completely used, replace with Grizzly Model G2820 Pneumatic Tool Oil.

An efficient alternative to oiling your tool by hand is to install a lubricator in your air compressor line. If your air compressor line already has a lubricator, then regular lubrication of your nailer will not be necessary. Just make sure there is always oil in the lubricator.

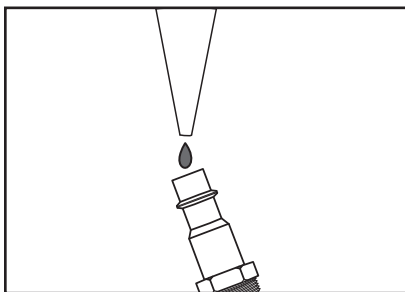

**Figure 15.** Lubricating the nailer at the air inlet.





# H7949 PARTS LIST

## PAGE 1 OF 2

REF	PART #	DESCRIPTION
1	PFH55M	FLAT HD CAP SCR M6-1 X 20
2	PH7949002	FRONT BRACKET
3	PH7949003	EXHAUST COVER
4	PH7949004	EXHAUST FILTER
5	PH7949005	EXHAUST FILTER PLATE
6	PSB38M	CAP SCREW M5-.8 X 25
7	PH7949007	CAP
8	PH7949008	SPRING
9	PH7949009	WASHER
10	PH7949010	O-RING
11	PH7949011	PISTON HEAD VALVE
12	PH7949012	O-RING
13	PH7949013	SEAL
14	PH7949014	PLAIN WASHER
15	PH7949015	PISTON STOPPER
16	PH7949016	O-RING
17	PH7949017	PISTON
18	PH7949018	DRIVER
19	PH7949019	CYLINDER
20	PH7949020	O-RING
21	PH7949021	CYLINDER RING
22	PH7949022	COLLAR
23	PH7949023	O-RING
24	PH7949024	GASKET
25	PH7949025	BODY
26	PH7949026	PAD
27	PH7949027	O-RING
28	PH7949028	BOTTOM BUMPER
29	PH7949029	O-RING
30	PH7949030	NOSE
31	PSB02M	CAP SCREW M6-1 X 20
32	PH7949032	STEPPED PIN
33	PH7949033	RETAIN RUBBER
34	PH7949034	RETAIN RUBBER
35	PH7949035	CHECK PAWL
36	PH7949036	SPRING
37	PH7949037	STEPPED PIN
38	PH7949038	PROTECTOR
39	PH7949039	FEED PAWL

REF	PART #	DESCRIPTION
40	PH7949040	STEPPED PIN
41	PH7949041	O-RING
42	PH7949042	FEED PISTON
43	PH7949043	O-RING
44	PH7949044	SPRING
45	PH7949045	SPRING
46	PH7949046	FEED PISTON STOP
47	PH7949047	SPRING COLLAR
48	PH7949048	O-RING
49	PH7949049	STEPPED PIN
50	PH7949050	RATCHET
51	PH7949051	SPRING
52	PH7949052	DOOR
53	PH7949053	SAFETY SUPPORT
54	PH7949054	SPRING
55	PH7949055	SET SHAFT
56	PH7949056	SLIDE ROD
57	PH7949057	MAGAZINE
58	PSBS09M	BUTTON HD CAP SCR M5-.8 X 12
59	PSB15M	CAP SCREW M5-.8 X 20
60	PLN02M	LOCK NUT M5-.8
61	PH7949061	MAGAZINE COVER
62	PRP42M	ROLL PIN 3 X 20
63	PH7949063	RUBBER INSERT
64	PH7949064	SAFETY LEVER
65	PH7949065	DUST COVER
66	PW03M	FLAT WASHER 6MM
67	PSBS06M	BUTTON HD CAP SCR M5-.8 X 12
68	PH7949068	NOSE COVER
69	PH7949069	PALLET TIP
70	PH7949070	SIDING TIP
71	PH7949071	DECKING TIP
72	PRP97M	ROLL PIN 3 X 30
73	PH7949073	TRIGGER VALVE CAP
74	PH7949074	O-RING
75	PH7949075	PLUNGER
76	PH7949076	SPRING
77	PH7949077	O-RING
78	PH7949078	O-RING

# H7949 PARTS LIST

## PAGE 2 OF 2

REF	PART #	DESCRIPTION
79	PH7949079	PILOT VALVE
80	PH7949080	O-RING
81	PH7949081	BALL PIN
82	PH7949082	TRIGGER VALVE HOUSING
83	PH7949083	O-RING
84	PH7949084	O-RING
85	PH7949085	TRIGGER PLATE
86	PH7949086	TRIGGER
87	PRP98M	ROLL PIN 3 X 16
88	PH7949088	SLIDE SHAFT
89	PH7949089	SPRING
90	PH7949090	TRIP GUIDE
91	PH7949091	SPRING

REF	PART #	DESCRIPTION
92	PH7949092	CONTACT TRIP BLOCK
93	PH7949093	ADJUSTING BOLT
94	PH7949094	COVER
95	PH7949095	O-RING
96	PH7949096	RUBBER GRIP
97	PH7949097	ADJUSTING NUT
98	PH7949098	NAILER CASE
100	PH7949100	INCLUDED PNEUMATIC OIL
101	PAW04M	HEX WRENCH 4MM
102	PAW05M	HEX WRENCH 5MM
103	PH7949103	PISTON REPAIR KIT
104	PH7949104	MACHINE LABEL

# H7950 PARTS BREAKDOWN

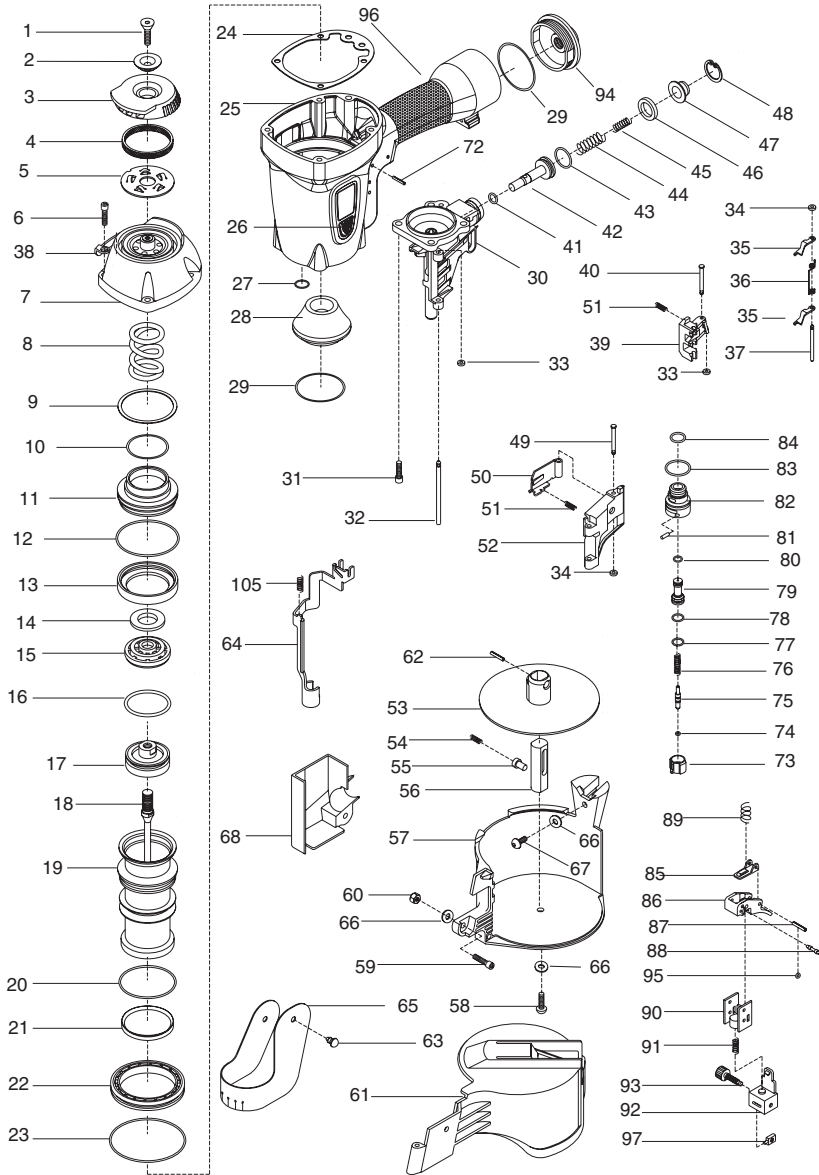

\*Not Shown: # 69 Pallet Tip, #70 Siding Tip, #71 Decking Tip, #98 Nailer Case, #100 Included Pneumatic Oil, #101 Hex Wrench 4mm, #102 Hex Wrench 5mm, #103 Piston Repair Kit, #104 Machine Label.

# H7950 PARTS LIST

## PAGE 1 OF 2

REF	PART #	DESCRIPTION
1	PFH06M	FLAT HD CAP SCR M6-1 X 20
2	PH7949002	FRONT BRACKET
3	PH7950003	EXHAUST COVER
4	PH7949004	EXHAUST FILTER
5	PH7950005	EXHAUST FILTER PLATE
6	PSB06M	CAP SCREW M6-1 X 25
7	PH7950007	CAP
8	PH7949008	SPRING
9	PH7949009	WASHER
10	PH7949010	O-RING
11	PH7949011	PISTON HEAD VALVE
12	PH7949012	O-RING
13	PH7949013	SEAL
14	PH7949014	PLAIN WASHER
15	PH7949015	PISTON STOPPER
16	PH7950016	O-RING
17	PH7950017	PISTON
18	PH7950018	DRIVER
19	PH7950019	CYLINDER
20	PH7950020	O-RING
21	PH7950021	CYLINDER RING
22	PH7950022	COLLAR
23	PH7950023	O-RING
24	PH7950024	GASKET
25	PH7950025	BODY
26	PH7949026	PAD
27	PH7949027	O-RING
28	PH7950028	BOTTOM BUMPER
29	PH7949029	O-RING
30	PH7950030	NOSE
31	PSB14M	CAP SCREW M8-1.25 X 20
32	PH7949032	STEPPED PIN
33	PH7949033	RETAIN RUBBER
34	PH7949034	RETAIN RUBBER
35	PH7949035	CHECK PAWL
36	PH7949036	SPRING
37	PH7949037	STEPPED PIN
38	PH7950038	PROTECTOR
39	PH7949039	FEED PAWL

REF	PART #	DESCRIPTION
40	PH7949040	STEPPED PIN
41	PH7949041	O-RING
42	PH7949042	FEED PISTON
43	PH7949043	O-RING
44	PH7949044	SPRING
45	PH7949045	SPRING
46	PH7949046	FEED PISTON STOP
47	PH7949047	SPRING COLLAR
48	PH7949048	O-RING
49	PH7950049	STEPPED PIN
50	PH7949050	RATCHET
51	PH7949051	SPRING
52	PH7950052	DOOR
53	PH7949053	NAIL SUPPORT
54	PH7949054	SPRING
55	PH7949055	SET SHAFT
56	PH7949056	SLIDE ROD
57	PH7950057	MAGAZINE
58	PSBS09M	BUTTON HD CAP SCR M5-.8 X 12
59	PSB15M	CAP SCREW M5-.8 X 20
60	PLN02M	LOCK NUT M5-.8
61	PH7949061	MAGAZINE COVER
62	PRP42M	ROLL PIN 3 X 20
63	PH7949063	RUBBER INSERT
64	PH7950064	SAFETY LEVER
65	PH7949065	DUST COVER
66	PW03M	FLAT WASHER 6MM
67	PSBS06M	BUTTON HD CAP SCR M5-.8 X 12
68	PH7950068	NOSE COVER
69	PH7950069	PALLET TIP
70	PH7950070	SIDING TIP
71	PH7950071	DECKING TIP
72	PRP97M	ROLL PIN 3 X 30
73	PH7949073	TRIGGER VALVE CAP
74	PH7949074	O-RING
75	PH7949075	PLUNGER
76	PH7949076	SPRING
77	PH7949077	O-RING
78	PH7949078	O-RING

# H7950 PARTS LIST

## PAGE 2 OF 2

REF PART #	DESCRIPTION
79	PH7949079 PILOT VALVE
80	PH7949080 O-RING
81	PH7949081 BALL PIN
82	PH7949082 TRIGGER VALVE HOUSING
83	PH7949083 O-RING
84	PH7949084 O-RING
85	PH7949085 TRIGGER PLATE
86	PH7949086 TRIGGER
87	PRP98M ROLL PIN 3 X 16
88	PH7949088 SLIDE SHAFT
89	PH7949089 SPRING
90	PH7949090 TRIP GUIDE
91	PH7949091 SPRING

REF PART #	DESCRIPTION
92	PH7949092 CONTACT TRIP BLOCK
93	PH7949093 ADJUSTING BOLT
94	PH7950094 COVER
95	PH7949095 O-RING
96	PH7949096 RUBBER GRIP
97	PH7949097 ADJUSTING NUT
98	PH7950098 NAILER CASE
100	PH7949100 INCLUDED PNEUMATIC OIL
101	PAW04M HEX WRENCH 4MM
102	PAW05M HEX WRENCH 5MM
103	PH7950103 PISTON REPAIR KIT
104	PH7950104 MACHINE LABEL
105	PH7950105 SPRING

# H7951 PARTS BREAKDOWN

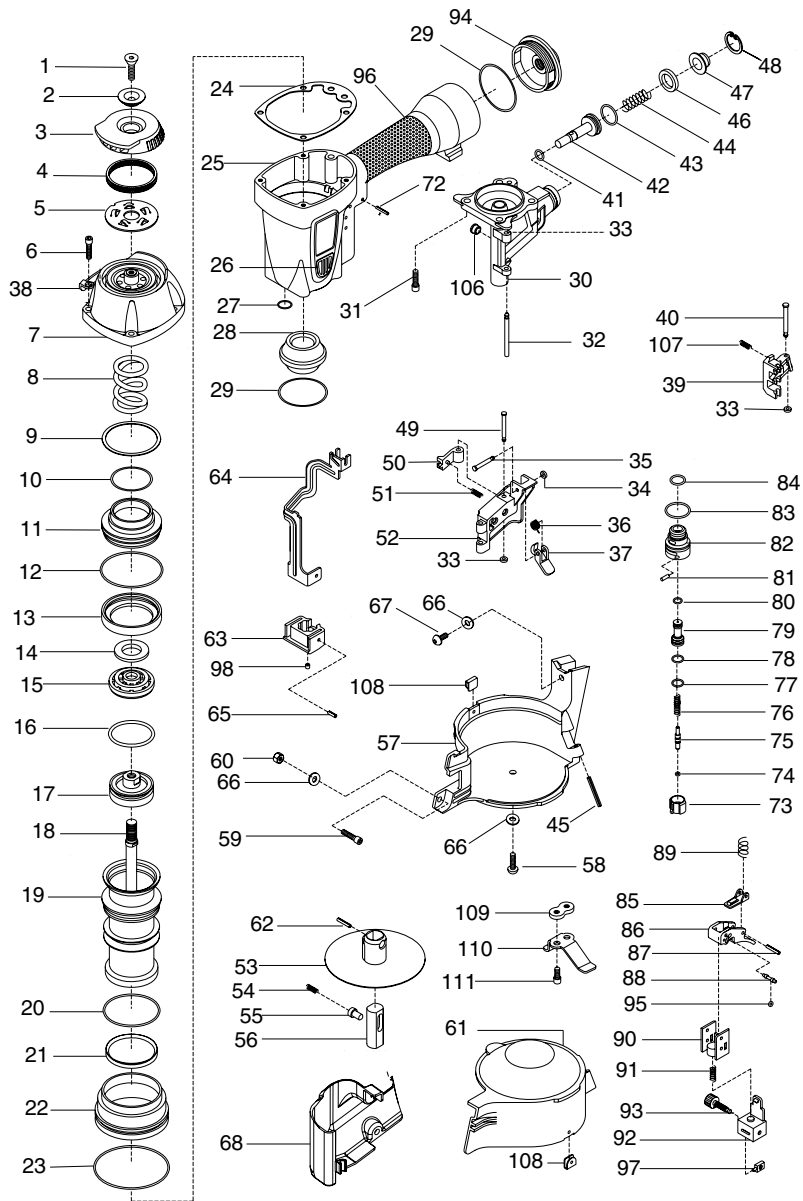

\*Not Shown: #69 Pallet Tip, #70 Siding Tip, #71 Decking Tip, #99 Nailer Case, #101 Included Pneumatic Oil, #102 Hex Wrench 4mm, #103 Hex Wrench 5mm, #104 Piston Repair Kit, #105 Machine Label.

# H7951 PARTS LIST

## PAGE 1 OF 2

REF	PART #	DESCRIPTION
1	PHF55M	FLAT HD CAP SCR M6-1 X 20
2	PH7949002	FRONT BRACKET
3	PH7949003	EXHAUST COVER
4	PH7949004	EXHAUST FILTER
5	PH7949005	EXHAUST FILTER PLATE
6	PSB38M	CAP SCREW M5-.8 X 25
7	PH7949007	CAP
8	PH7949008	SPRING
9	PH7949009	WASHER
10	PH7949010	O-RING
11	PH7949011	PISTON HEAD VALVE
12	PH7949012	O-RING
13	PH7949013	SEAL
14	PH7949014	PLAIN WASHER
15	PH7949015	PISTON STOPPER
16	PH7949016	O-RING
17	PH7949017	PISTON
18	PH7951018	DRIVER
19	PH7951019	CYLINDER
20	PH7949020	O-RING
21	PH7949021	CYLINDER RING
22	PH7949022	COLLAR
23	PH7949023	O-RING
24	PH7949024	GASKET
25	PH7949025	BODY
26	PH7949026	PAD
27	PH7949027	O-RING
28	PH7949028	BOTTOM BUMPER
29	PH7949029	O-RING
30	PH7951030	NOSE
31	PSB02M	CAP SCREW M6-1 X 20
32	PH7951032	STEPPED PIN
33	PH7949033	RETAIN RUBBER
34	PH7949034	RETAIN RUBBER
35	PH7951035	STEPPED PIN
36	PH7951036	SPRING
37	PH7951037	DOOR LOCK
38	PH7949038	PROTECTOR
39	PH7951039	FEED PAWL

REF	PART #	DESCRIPTION
40	PH7951040	STEPPED PIN
41	PH7949041	O-RING
42	PH7951042	FEED PISTON
43	PH7949043	O-RING
44	PH7949044	SPRING
45	PRP22M	ROLL PIN 4 X 32
46	PH7949046	FEED PISTON STOP
47	PH7949047	SPRING COLLAR
48	PH7949048	O-RING
49	PH7951049	STEPPED PIN
50	PH7951050	RATCHET
51	PH7949051	SPRING
52	PH7951052	DOOR
53	PH7951053	NAIL SUPPORT
54	PH7949054	SPRING
55	PH7949055	SET SHAFT
56	PH7951056	SLIDE ROD
57	PH7951057	MAGAZINE
58	PSBS09M	BUTTON HD CAP SCR M5-.8 X 12
59	PSB53M	CAP SCREW M5-.8 X 18
60	PLN02M	LOCK NUT M5-.8
61	PH7951061	MAGAZINE COVER
62	PRP42M	ROLL PIN 3 X 20
63	PH7951063	ADJUSTING BLOCK
64	PH7951064	SAFETY LEVER
65	PH7951065	ROLL PIN 3 X 8
66	PW03M	FLAT WASHER 6MM
67	PSBS06M	BUTTON HD CAP SCR M5-.8 X 12
68	PH7951068	NOSE COVER
69	PH7951069	PALLET TIP
70	PH7951070	SIDING TIP
71	PH7951071	DECKING TIP
72	PRP97M	ROLL PIN 3 X 30
73	PH7949073	TRIGGER VALVE CAP
74	PH7949074	O-RING
75	PH7949075	PLUNGER
76	PH7949076	SPRING
77	PH7949077	O-RING
78	PH7949078	O-RING



# H7951 PARTS LIST

## PAGE 2 OF 2

REF	PART #	DESCRIPTION
79	PH7949079	PILOT VALVE
80	PH7949080	O-RING
81	PH7949081	BALL PIN
82	PH7949082	TRIGGER VALVE HOUSING
83	PH7949083	O-RING
84	PH7949084	O-RING
85	PH7949085	TRIGGER PLATE
86	PH7949086	TRIGGER
87	PRP98M	ROLL PIN 3 X 16
88	PH7949088	SLIDE SHAFT
89	PH7949089	SPRING
90	PH7949090	TRIP GUIDE
91	PH7949091	SPRING
92	PH7949092	CONTACT TRIP BLOCK
93	PH7949093	ADJUSTING BOLT

REF	PART #	DESCRIPTION
94	PH7949094	COVER
95	PH7949095	O-RING
96	PH7949096	RUBBER GRIP
97	PH7949097	ADJUSTING NUT
98	PH7951098	CARBIDE CHIP
99	PH7951099	NAILER CASE
101	PH7949100	INCLUDED PNEUMATIC OIL
102	PAW04M	HEX WRENCH 4MM
103	PAW05M	HEX WRENCH 5MM
104	PH7951104	PISTON REPAIR KIT
105	PH7951105	GRIZZLY LABEL
106	PH9751106	MAGNET
107	PH9751107	SPRING
108	PH9751108	PROTECT PLATE

# TROUBLESHOOTING

Symptom	Possible Cause	Solution
Air leaking at trigger valve area.	<ol style="list-style-type: none"> <li>1. O-rings in trigger valve housing are damaged.</li> </ol>	<ol style="list-style-type: none"> <li>1. O-rings must be replaced.</li> </ol>
Air leaking between housing and hose.	<ol style="list-style-type: none"> <li>1. Loose screws in housing.</li> <li>2. Damaged O-ring.</li> <li>3. Loose air fitting.</li> </ol>	<ol style="list-style-type: none"> <li>1. Tighten screws.</li> <li>2. Replace O-ring.</li> <li>3. Tighten air fitting &amp; use Teflon tape.</li> </ol>
Air leaking between housing and cap assembly.	<ol style="list-style-type: none"> <li>1. Damaged cap gasket.</li> </ol>	<ol style="list-style-type: none"> <li>1. Replace gasket.</li> </ol>
Tool skips nails while discharging.	<ol style="list-style-type: none"> <li>1. Air leaks.</li> <li>2. Dirt in nose.</li> <li>3. Dirt or damage prevents nails from moving freely in magazine.</li> <li>4. Inadequate air flow to tool.</li> <li>5. Worn O-ring on piston or lack of lubrication.</li> <li>6. Damaged O-rings on trigger valve.</li> <li>7. Worn bumper.</li> </ol>	<ol style="list-style-type: none"> <li>1. Tighten screws and fittings.</li> <li>2. Clean nose.</li> <li>3. Clean magazine, inspect/repair damage; insert a clean strip of nails.</li> <li>4. Check fitting, hose, compressor &amp; air pressure.</li> <li>5. Replace piston O-ring. Lubricate.</li> <li>6. Replace trigger valve O-rings.</li> <li>7. Replace bumper.</li> </ol>
Tool runs slowly or has a loss of power.	<ol style="list-style-type: none"> <li>1. Nailer is not sufficiently lubricated.</li> <li>2. Compressor is not supplying at least 70 PSI of air pressure to the tool.</li> <li>3. Exhaust port in cap is blocked.</li> </ol>	<ol style="list-style-type: none"> <li>1. Lubricate nailer.</li> <li>2. Repair or replace your compressor.</li> <li>3. Clean or replace damaged internal parts.</li> </ol>
Nails frequently jam in the nailer nose.	<ol style="list-style-type: none"> <li>1. Nails are the wrong size.</li> <li>2. Nails are bent or dirty.</li> <li>3. Magazine or nose screws are loose.</li> <li>4. Driver or driver guide are worn or damaged.</li> <li>5. Nails are wrong angle.</li> </ol>	<ol style="list-style-type: none"> <li>1. Use correct nails.</li> <li>2. Use undamaged, clean nails.</li> <li>3. Tighten magazine.</li> <li>4. Replace worn or damaged parts.</li> <li>5. Use correct angle nails.</li> </ol>
Nailer does not fire.	<ol style="list-style-type: none"> <li>1. Nail is jammed in magazine or discharge area.</li> <li>2. Piston shaft is damaged.</li> <li>3. Air pressure too low.</li> </ol>	<ol style="list-style-type: none"> <li>1. Clear nailer magazine or discharge area.</li> <li>2. Replace piston shaft.</li> <li>3. Check/increase air pressure.</li> </ol>

# WARRANTY AND RETURNS

---

Grizzly Industrial, Inc. warrants every product it sells for a period of **1 year** to the original purchaser from the date of purchase. This warranty does not apply to defects due directly or indirectly to misuse, abuse, negligence, accidents, repairs or alterations or lack of maintenance. This is Grizzly's sole written warranty and any and all warranties that may be implied by law, including any merchantability or fitness, for any particular purpose, are hereby limited to the duration of this written warranty. We do not warrant or represent that the merchandise complies with the provisions of any law or acts unless the manufacturer so warrants. In no event shall Grizzly's liability under this warranty exceed the purchase price paid for the product and any legal actions brought against Grizzly shall be tried in the State of Washington, County of Whatcom.

We shall in no event be liable for death, injuries to persons or property or for incidental, contingent, special, or consequential damages arising from the use of our products.

To take advantage of this warranty, contact us by mail or phone and give us all the details. We will then issue you a "Return Authorization Number," which must be clearly posted on the outside as well as the inside of the carton. We will not accept any item back without this number. Proof of purchase must accompany the merchandise.

The manufacturers reserve the right to change specifications at any time because they constantly strive to achieve better quality equipment. We make every effort to ensure that our products meet high quality and durability standards and we hope you never need to use this warranty.

Please feel free to write or call us if you have any questions about the machine or the manual.

**Grizzly Industrial, Inc.**  
**1203 Lycoming Mall Circle**  
**Muncy, PA 17756**  
**Phone: (570) 546-9663**  
**Fax: (800) 438-5901**

**E-Mail:**  
**techsupport@grizzly.com**

**Web Site: <http://www.grizzly.com>**

Thank you again for your business and continued support. We hope to serve you again soon!





# WARRANTY CARD

Name \_\_\_\_\_

Street \_\_\_\_\_

City \_\_\_\_\_ State \_\_\_\_\_ Zip \_\_\_\_\_

Phone # \_\_\_\_\_ Email \_\_\_\_\_ Invoice # \_\_\_\_\_

Model # \_\_\_\_\_ Order # \_\_\_\_\_ Serial # \_\_\_\_\_

*The following information is given on a voluntary basis. It will be used for marketing purposes to help us develop better products and services. **All information is strictly confidential.***

**1. How did you learn about us?**

Advertisement     Friend     Catalog  
 Card Deck     Website    Other: \_\_\_\_\_

**2. Which of the following magazines do you subscribe to?**

Cabinet Maker     Popular Mechanics     Today's Homeowner  
 Family Handyman     Popular Science     Wood  
 Hand Loader     Popular Woodworking     Wooden Boat  
 Handy     Practical Homeowner     Woodshop News  
 Home Shop Machinist     Precision Shooter     Woodsmith  
 Journal of Light Cont.     Projects in Metal     Woodwork  
 Live Steam     RC Modeler     Woodworker West  
 Model Airplane News     Rifle     Woodworker's Journal  
 Modeltec     Shop Notes     Other:  
 Old House Journal     Shotgun News

**3. What is your annual household income?**

\$20,000-\$29,000     \$30,000-\$39,000     \$40,000-\$49,000  
 \$50,000-\$59,000     \$60,000-\$69,000     \$70,000+

**4. What is your age group?**

20-29     30-39     40-49  
 50-59     60-69     70+

**5. How long have you been a woodworker/metalworker?**

0-2 Years     2-8 Years     8-20 Years     20+ Years

**6. How many of your machines or tools are Grizzly?**

0-2     3-5     6-9     10+

**7. Do you think your machine represents a good value?**     Yes     No

**8. Would you recommend Grizzly Industrial to a friend?**     Yes     No

**9. Would you allow us to use your name as a reference for our customers in your area?**

Note: *We never use names more than 3 times.*     Yes     No

**10. Comments:** \_\_\_\_\_

\_\_\_\_\_

\_\_\_\_\_

\_\_\_\_\_

Send a Grizzly Catalog to a friend:

Name _____
Street _____
City _____ State _____ Zip _____

FOLD ALONG DOTTED LINE

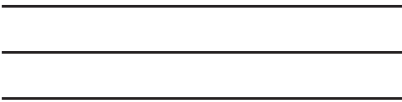

Place  
Stamp  
Here



GRIZZLY INDUSTRIAL, INC.  
P.O. BOX 2069  
BELLINGHAM, WA 98227-2069



TAPE ALONG EDGES--PLEASE DO NOT STAPLE







## Free Manuals Download Website

<http://myh66.com>

<http://usermanuals.us>

<http://www.somanuals.com>

<http://www.4manuals.cc>

<http://www.manual-lib.com>

<http://www.404manual.com>

<http://www.luxmanual.com>

<http://aubethermostatmanual.com>

Golf course search by state

<http://golfingnear.com>

Email search by domain

<http://emailbydomain.com>

Auto manuals search

<http://auto.somanuals.com>

TV manuals search

<http://tv.somanuals.com>