

Grizzly **Industrial, Inc.**®

34° CLIPPED HEAD FRAMING NAILER

MODEL H6146

INSTRUCTION MANUAL



COPYRIGHT © FEBRUARY, 2005 BY GRIZZLY INDUSTRIAL, INC.
**WARNING: NO PORTION OF THIS MANUAL MAY BE REPRODUCED IN ANY SHAPE
OR FORM WITHOUT THE WRITTEN APPROVAL OF GRIZZLY INDUSTRIAL, INC.**
#BL6906 PRINTED IN CHINA

SAFETY

WARNING

For Your Own Safety Read Instruction Manual Before Operating This Equipment

The purpose of safety symbols is to attract your attention to possible hazardous conditions. This manual uses a series of symbols and signal words which are intended to convey the level of importance of the safety messages. The progression of symbols is described below. Remember that safety messages by themselves do not eliminate danger and are not a substitute for proper accident prevention measures.



Indicates an imminently hazardous situation which, if not avoided, WILL result in death or serious injury.



Indicates a potentially hazardous situation which, if not avoided, COULD result in death or serious injury.



Indicates a potentially hazardous situation which, if not avoided, MAY result in minor or moderate injury. It may also be used to alert against unsafe practices.

NOTICE

This symbol is used to alert the user to useful information about proper operation of the equipment.

WARNING

Safety Instructions for Machinery

- 1. READ THROUGH THE ENTIRE MANUAL BEFORE STARTING MACHINERY.** Machinery presents serious injury hazards to untrained users.
- 2. MAKE SURE ALL GUARDS ARE IN THEIR CORRECT PLACE AND WORK CORRECTLY BEFORE USING MACHINERY. NEVER OPERATE MACHINE WITHOUT GUARDS.**
- 3. ALWAYS USE ANSI APPROVED SAFETY GLASSES WHEN OPERATING MACHINERY.**
- 4. WEAR PROPER APPAREL.** DO NOT wear loose clothing, gloves, neckties, rings, or jewelry which may get caught in moving parts. Wear protective hair covering to contain long hair and wear non-slip footwear.
- 5. NEVER OPERATE MACHINERY WHEN TIRED, OR UNDER THE INFLUENCE OF DRUGS OR ALCOHOL.** Be mentally alert at all times when running machinery.

6. **ONLY ALLOW TRAINED AND PROPERLY SUPERVISED PERSONNEL TO OPERATE MACHINERY.** Make sure operation instructions are safe and clearly understood.
7. **KEEP CHILDREN AND VISITORS AWAY.** Keep all children and visitors a safe distance from the work area.
8. **MAKE WORKSHOP CHILD PROOF.** Use padlocks, master switches, and remove start switch keys.
9. **NEVER LEAVE WHEN MACHINE IS RUNNING.** Turn power **OFF** and allow all moving parts to come to a complete stop before leaving machine unattended.
10. **DO NOT USE IN DANGEROUS ENVIRONMENTS.** DO NOT use machinery in damp, wet locations, or where any flammable or noxious fumes may exist.
11. **KEEP WORK AREA CLEAN AND WELL LIT.** Clutter and dark shadows may cause accidents.
12. **USE A GROUNDED EXTENSION CORD RATED FOR THE MACHINE AMPERAGE.** Undersized cords overheat and reduce voltage. Replace extension cords if they become damaged. DO NOT use extension cords for 220V machinery.
13. **ALWAYS DISCONNECT FROM POWER SOURCE BEFORE SERVICING MACHINERY.** Make sure switch is in OFF position before reconnecting.
14. **MAINTAIN MACHINERY WITH CARE.** Keep blades sharp and clean for best and safest performance. Follow instructions for lubricating and changing accessories.
15. **REMOVE ADJUSTING KEYS AND WRENCHES.** Make a habit of checking for keys and adjusting wrenches before turning **ON** machinery.
16. **CHECK FOR DAMAGED PARTS BEFORE USING MACHINERY.** Check for binding and alignment of parts, broken parts, part mounting, loose bolts, and any other conditions that may affect machine operation. Repair or replace damaged parts.
17. **USE RECOMMENDED ACCESSORIES.** Refer to the instruction manual for recommended accessories. The use of improper accessories may cause risk of injury.
18. **DO NOT FORCE MACHINERY.** Work at the speed for which the machine or accessory was designed.

WARNING

Additional Safety Instructions for Nailers

1. **HAND INJURIES:** Do not place your hands near the nail point of entry. A nail can deflect and tear through the surface of the workpiece, puncturing your hand or fingers.
2. **COMBUSTIBLE GASES:** Never connect the nailer to pressurized oxygen or other combustible gases as a power source. Only use filtered, lubricated, and regulated compressed air.
3. **SAFE HANDLING:** Never point the nailer at others! Do not keep the trigger pulled when loading fasteners, carrying, or holding tool. Carry the nailer only by the handle, never by any other part. Do not carry the nailer by the air hose. Disconnect the nailer from the air hose when going up and down ladders.
4. **CLEANING:** Never use gasoline or other flammable liquids to clean the nailer; vapors in the nailer will ignite by a spark and cause it to explode.
5. **HOSE USAGE:** Make sure your air hose is designed for the tool in use, is in good condition, and is long enough to reach your work without stretching. However, an overly long air hose in the work area may be a tripping hazard.
6. **OPERATING QUESTIONS:** If you are not sure about the intended operation, stop using the nailer. Seek formal training or research books or magazines that specialize in pneumatic tools.
7. **MAINTENANCE:** Always disconnect air from the nailer when servicing or installing nails. During maintenance, a nailer connected to air may fire accidentally, causing serious personal injury.
8. **COMPRESSED AIR RATING:** Do not connect the nailer to compressed air that exceeds 120 PSI.
9. **CHECK VALVE:** Do not use a check valve or any other fitting that allows air to remain in the tool.

! WARNING

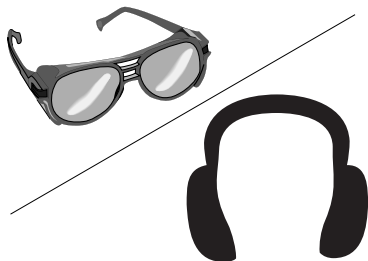

Operating this nailer can propel objects into the air, causing immediate eye damage. To protect yourself, always wear American National Standards Institute (ANSI) approved safety glasses or goggles when operating this equipment. In addition, this nailer discharges at 85-90 decibels. To protect your hearing, always wear ANSI approved ear protection when operating this nailer.

! WARNING

Never point this nailer at yourself or another person! Always pay attention to the direction this nailer is pointed. Use this tool with respect and caution to lessen the possibility of operator or bystander injury. Ignoring this warning may result in serious personal injury.

! CAUTION

No list of safety guidelines can be complete. Every shop environment is different. Always consider safety first, as it applies to your individual working conditions. Use this and other tools with caution and respect. Failure to do so could result in serious personal injury, damage to equipment or poor work results.

INTRODUCTION

Foreword

We are proud to offer the Grizzly Model H6146 34° Clipped Head Framing Nailer. This model is part of a growing Grizzly family of fine pneumatic tools. When used according to the guidelines set forth in this manual, you can expect years of trouble-free, enjoyable operation and proof of Grizzly's commitment to customer satisfaction.

The Model H6146 is designed to toenail into corners. This nailer is ideal for framing, pallet and crate assembly, and deck, roof, fencing and sidewall sheathing construction. The Model H6146 features a 360° exhaust port, comfort grip rubber handle, and economical air consumption with low noise.

The specifications, details, and photographs in this manual represent the Model H6146 as supplied when the manual was prepared. However, owing to Grizzly's policy of continuous improvement, changes may be made at any time with no obligation on the part of Grizzly.

Machine Data

Nail Size $\frac{7}{64}$ "- $\frac{1}{8}$ " Shank Diameter
Nail Strip Angle..... 34°
Nail Length 2"-3 $\frac{1}{2}$ "(Clipped Headed)
Magazine Capacity 100 Nails
Air Inlet $\frac{1}{4}$ " NPT
Weight 8 $\frac{1}{2}$ lbs.
Operating Pressure 70-120 PSI

Contact Info

If you have any comments regarding this manual, please write to us at the following address:

Grizzly Industrial, Inc.
C/O Technical Documentation
P.O. Box 2069
Bellingham, WA 98227-2069

Most importantly, we stand behind our tools. If you have any service questions or parts requests, please call or write us at the location listed below.

Grizzly Industrial, Inc.
1203 Lycoming Mall Circle
Muncy, PA 17756
Phone: (570) 546-9663
Fax: (800) 438-5901

E-Mail: techsupport@grizzly.com
Web Site: <http://www.grizzly.com>

! WARNING

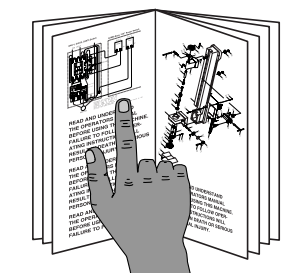

Read the manual before operation. Become familiar with this nailer, its safety instructions, and its operation before beginning any work. Serious personal injury may result if safety or operational information is not understood or followed.

SET UP

Unpacking

Your Model H6146 left our warehouse in a carefully packed box. If you discover the nailer is damaged after you have signed for delivery, *please immediately call Customer Service at (570) 546-9663 for advice.*

Save the containers and all packing materials for possible inspection by the carrier or its agent. *Otherwise, filing a freight claim can be difficult.*

When you are completely satisfied with the condition of the shipment, you should inventory the equipment.

Inventory

After you open the nailer box, you should find the following.

Model H6146 Inventory (Figure 1)

- A. 34° Clipped Head Framing Nailer 1
- B. Safety Goggles 1
- C. Oil..... 1
- D. Hex Wrench 3MM 1
- E. Hex Wrench 4MM 1
- F. Hex Wrench 5MM 1
- G. Hex Wrench 6MM 1

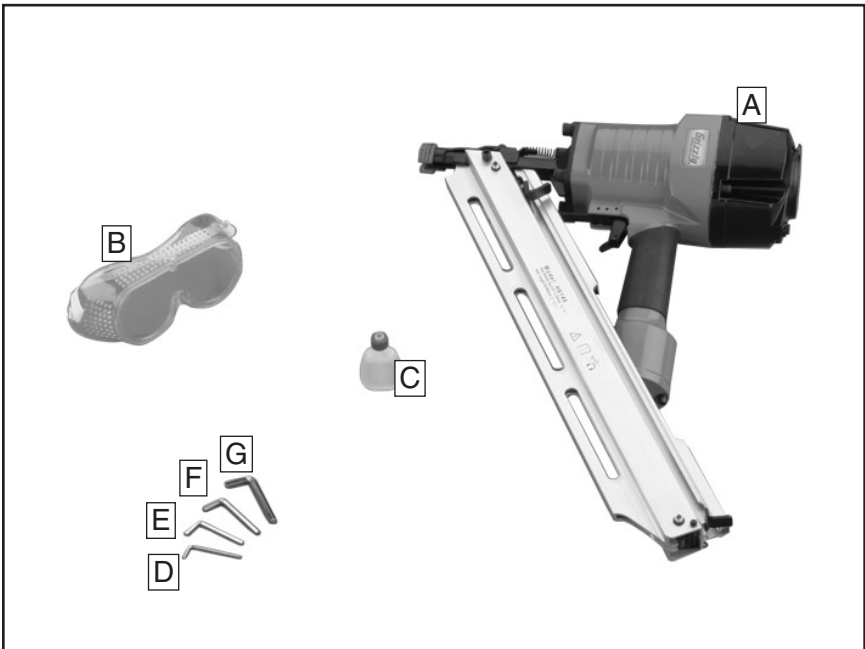

Figure 1. Model H6146 inventory.

Compressed Air System

The Model H6146 is designed to be operated at 70-120 PSI using clean, dry, regulated, compressed air. **DO NOT exceed the maximum operating pressure for your model.**

Before using your new nailer, regulate the air pressure on your air compressor to the minimum PSI for your model.

An in-line filter/lubricator/regulator unit, depicted in **Figure 2**, can be installed and should be located as close to the nailer as possible.

This filter/lubricator/regulator unit will protect your tool from damaging water build-up, allow you to adjust and maintain constant air pressure to your tool, and save you the inconvenience of having to manually lubricate your tool every time you use it.

WARNING

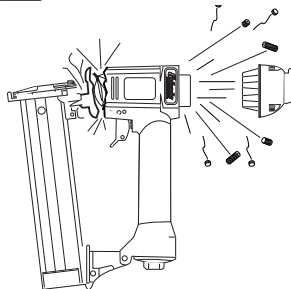

Exceeding the maximum permissible operating pressure may cause the nailer to explode, blowing metal fragments in all directions. To protect yourself from serious personal injury, DO NOT allow your air compressor to exceed the recommended pressure when connected to this nailer!

Check the current Grizzly catalog for availability of this unit. If you plan on installing a filter/lubricator/regulator unit in your compressed air system, always follow the connection instructions that come with the unit.

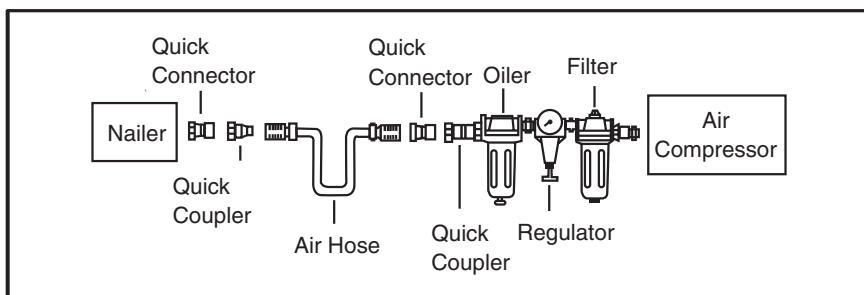

Figure 2. Filter/Lubricator/Regulator Unit.

Safety Yoke

A safety yoke mechanism (bump fire) on the nose of the nailer acts as a secondary safety device. When the trigger is pressed, the nailer will not fire until the safety yoke mechanism is depressed.

Before you use your nailer for the first time, check the safety yoke mechanism to ensure proper function. To do this:

1. **DISCONNECT NAILER FROM THE AIR SUPPLY!**
2. Make sure the magazine is empty and contains no nails.
3. Make sure the trigger and the safety yoke mechanism move up and down without sticking.
4. Connect the nailer to the air supply.

WARNING

The safety yoke is a mechanical device that can fail. Never rely on the safety yoke mechanism as an excuse to point the nailer at yourself or any bystanders. Serious injury may occur.

5. **Without pressing the trigger**, depress the safety yoke mechanism against a scrap piece of wood that is clean and free of any knots, nails, or other foreign objects.

- If the nailer does not fire, then the safety yoke mechanism is working correctly.
- If the nailer **does fire** when you do this, immediately disconnect the nailer from the air supply and call Grizzly Technical Support at (570) 546-9663 for help.
- If the nailer fires when the trigger is pulled, without the safety yoke mechanism being depressed, then the nailer is not working properly.
- If either of these two conditions develop after you have used your nailer for a period of time, check the lubrication of these mechanisms.

OPERATIONS

Loading

When replacing nails in your Model H6146, follow these guidelines:

Diameter: $\frac{7}{64}''$ - $\frac{1}{8}''$

Length: 2"-3 $\frac{1}{2}''$

Capacity: 100

Strip Angle: 34°

To load your nailer:

1. **DISCONNECT NAILER FROM THE AIR SUPPLY!**
2. Grip the nailer firmly, pull the magazine pusher back, and engage the catch lever as shown in **Figure 3**.

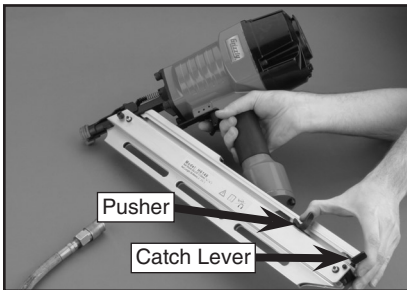

Figure 3. Sliding pusher toward the catch lever.

3. Insert a strip of nails, pointed-end down, into the magazine as shown in **Figure 4**.



Figure 4. Loading nails into magazine.

4. Slide the nails all the way down to the nose of the nailer.
5. Release the catch lever. The pusher slides forward until it rests against the nail stick.

Operating

If you have not read the safety instructions in this manual, do not operate the nailer.

Before you operate your nailer, place five to six drops of the included oil into the quick connect fitting where the nailer connects to the air supply.

To operate your nailer:

1. Connect the air supply to the quick connect fitting.
2. To test for proper nail penetration, hold the nailer perpendicular to the surface of a piece of clean scrap wood that is thick enough for the length of nails you have loaded.

3. Pull the trigger and depress the safety yoke mechanism on your workpiece.
4. Before pressing the trigger, make sure your free hand and other body parts are positioned out of the way of a potential path of a nail in case of deflection.

Deflection is caused when grain irregularities, knots or foreign objects inside the wood cause the nail to change its path, resulting in the nail puncturing the surface of the workpiece, as shown in **Figure 5**.

Besides damaging your workpiece, deflection can cause injury if your free hand is securing the workpiece in the location that the nail deflects.

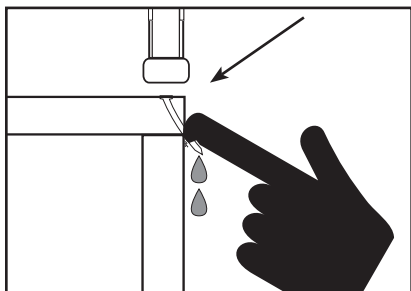

Figure 5. Example of nail deflection.

5. Pull the trigger. If the nail drove into the wood far enough, continue with your intended operations. If the nail either went too far or not far enough, then go to the *Adjusting Depth* section on this page.

Adjusting Depth

The nose of the gun houses a depth adjustment mechanism for setting the nail depth.

To adjust the depth:

1. **DISCONNECT NAILER FROM THE AIR SUPPLY!**
2. If the nail is driven too far into the workpiece, loosen the cap screw on the safety nose with a 4mm wrench, as shown in **Figure 6**.

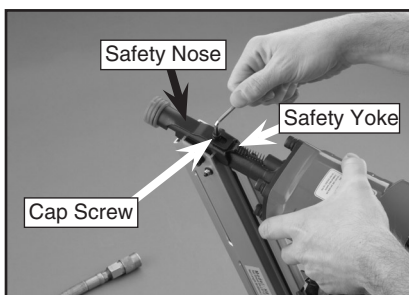

Figure 6. Loosening cap screw for depth adjustment.

3. Slide the safety nose (**Figure 6**) toward the nailer body to drive nails deeper, and away from the body to drive nails less deep.
4. Tighten the safety nose cap screw each time after making adjustments.
5. Connect to the air.
6. Pull the trigger and depress the safety yoke mechanism on your workpiece to test the depth adjustment.

Single/Bump Fire Mode

The nailer is designed to fire one nail at a time, or one after another, using the safety yoke mechanism.

To operate your nailer in single fire mode:

1. Depress the safety yoke mechanism against the workpiece.
2. Pull the trigger, then remove your finger from the trigger after the nail is driven.

To operate your nailer in bump fire mode:

1. Pull the trigger.
2. Press the safety yoke mechanism against your workpiece and raise it after the nail is driven.
3. Hold the trigger and repeat **Step 2** to drive more nails.

Clearing Jammed Nails

A jammed nail must be cleared before using the nailer again. The two places where a nail can get jammed are the magazine and the discharge area.

To clear a jammed nail from the magazine:

1. **DISCONNECT NAILER FROM THE AIR SUPPLY!**
2. Pull back and lock the magazine pusher.
3. Remove the nail stick.
4. Locate and remove the jammed nail with needle nose pliers. Release the catch lever and let the pusher slide front of the magazine.

To clear a jammed nail from the discharge area:

1. **DISCONNECT NAILER FROM THE AIR SUPPLY!**
2. Pull back and lock the magazine pusher in place.
3. Remove all nails from the magazine.
4. Locate the nail in the nailer nose, dislodge the nail with a tool that will fit in the slot on the underside of the nose.
5. Throw the damaged nail away and insert a new nail stick that only contains clean, undamaged nails. **DO NOT** use dirty or damaged nails!
6. Release the catch lever and let the pusher slide to the front of the magazine.

Replacing Pistons/O-Rings

If you use your nailer day in and day out, repair pistons are cheap insurance against wasted down time and lost profits, in the event that a piston or piston shaft becomes worn out.

WARNING

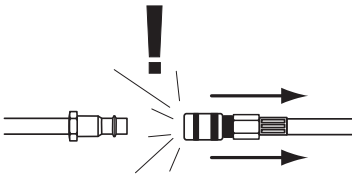

Always disconnect air from nailer whenever servicing! During maintenance, a nailer connected to air may fire accidentally, causing serious personal injury!

To replace a piston:

- 1. DISCONNECT NAILER FROM THE AIR SUPPLY!**
2. Remove all nails from the magazine cartridge.
3. Remove the four cap screws on the top of the nailer, near the exhaust port.
4. Remove the top cap.
5. The top of the piston should now be visible inside the cylinder, which is housed in the head of the nailer.
6. Open the magazine.
7. Watch the discharge area and push the top of the piston with your finger. You will see the piston shaft slide down the discharge area.
8. With a long flathead screwdriver or similarly shaped tool, push the piston shaft back inside the nailer until you can grip the piston head and remove it from the cylinder. (Be careful not to scratch the discharge area when pushing the piston shaft with the screwdriver.)
9. Place a new O-ring on the new piston and apply a thin film of the nailer lubricating oil on the O-ring.
10. Insert the new piston in the cylinder. Make sure that the grooves on the piston shaft line up with those on the guide at the bottom of the cylinder. The new piston should easily slide into the cylinder. **DO NOT force the piston into the cylinder!** If the piston is not easily inserted, double-check the alignment of the piston shaft with the grooves on the guide.
11. After the piston is inserted correctly, close the magazine. Replace the top cap assembly and tighten the 4 cap screws.
12. For more assistance, or to install a complete O-ring set, refer to the appropriate breakdown diagram in the back of this manual.

CLEANING & LUBRICATION

Cleaning

Use a good solvent to clean the nose assembly of the nailer. Always be sure that the nailer is dry before using it again.

Do not allow dust, chips, sand, etc. into the air connectors or into the body of the nailer; this may result in leaks and damage to the nailer and the air couplings.

! WARNING



Never use gasoline or other flammable liquids to clean this tool. Vapors in the tool may ignite, causing the tool to explode. Ignoring this warning may lead to serious personal injury or even death!

Lubricating

Special oil has been included with your new Grizzly nailer to help maintain its useful life. Place two to six drops of oil in the nailer air inlet (as shown in **Figure 7**) before every use, or after 2 hours of continuous use.

Wipe off any excess oil near the nailer exhaust to avoid dust build-up. When the oil that was included with the nailer has been completely used, replace with Grizzly Model G2820 Pneumatic Tool Oil.

Another option to manual oiling would be to install a lubricator in your air compressor line. If your air compressor line already has a lubricator, then regular lubrication of your nailer will not be necessary. Just make sure there is always oil in the lubricator.

As mentioned before, the best option is to install a filter/lubricator/regulator unit in your air line.

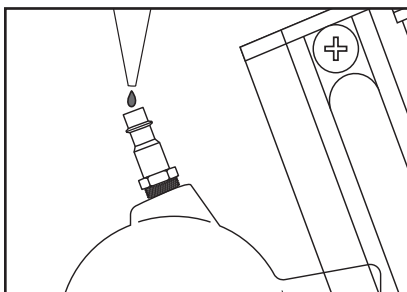
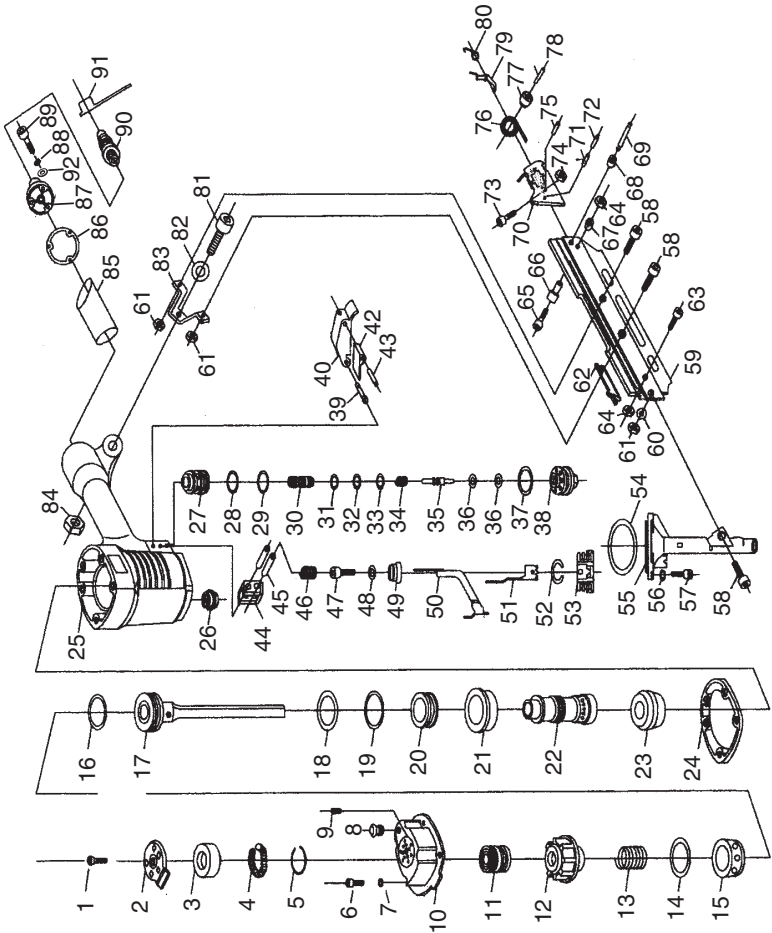

Figure 7. Lubricating nailer via air inlet.

H6146 PARTS BREAKDOWN



H6146 PARTS LIST

| PART # | DESCRIPTION | REF PART # | DESCRIPTION | | |
|--------|-------------|---------------------------|-------------|-----------|------------------------|
| 1 | PH6146001 | SPCL CAP SCR M8-1.25 X 30 | 47 | PSB03M | CAP SCREW M5-.8 X 8 |
| 2 | PH6146002 | AIR DEFLECTOR | 48 | PW02M | FLAT WASHER 5MM |
| 3 | PH6146003 | RUBBER WASHER | 49 | PH6146049 | ADJUSTING NUT |
| 4 | PH6146004 | SPRING | 50 | PH6146050 | SAFETY YOKE |
| 5 | PH6146005 | SPRING WIRE | 51 | PH6146051 | SAFETY NOSE |
| 6 | PSB06M | CAP SCREW M6-1 X 25 | 52 | PH6146052 | COPPER COLLAR |
| 7 | PLW03M | LOCK WASHER 6MM | 53 | PH6146053 | SAFETY NOSE CASE |
| 8 | PH6146008 | CYLINDER CORE | 54 | PH6146054 | O-RING 61.5 X 1.8 |
| 9 | PSS07M | SET SCREW M5-.8 X 5 | 55 | PH6146055 | DRIVER GUIDE |
| 10 | PH6146010 | CYLINDER COVER | 56 | PLW04M | LOCK WASHER 8MM |
| 11 | PH6146011 | HEAD VALVE PISTON | 57 | PSB13M | CAP SCREW M8-1.25 X 30 |
| 12 | PH6146012 | SPRING SEAT | 58 | PS14M | PHLP HD SCR M6-1 X 12 |
| 13 | PH6146013 | COMPRESSION SPRING | 59 | PH6146059 | MAGAZINE |
| 14 | PH6146014 | O-RING 56.7 X 3 | 60 | PW03M | FLAT WASHER 6MM |
| 15 | PH6146015 | COLLAR | 61 | PLN03M | LOCK NUT M6-1 |
| 16 | PH6146016 | O-RING 42.3 X 5 | 62 | PH6146062 | DRIVE NAIL BAR |
| 17 | PH6146017 | PISTON | 63 | PSB18M | CAP SCREW M4-.7 X 8 |
| 18 | PH6146018 | O-RING 57.5 X 3 | 64 | PLN01M | LOCK NUT M4-.7 |
| 19 | PH6146019 | O-RING 88 X 3 | 65 | PSB46M | CAP SCREW M4-.7 X 40 |
| 20 | PH6146020 | FIXED RING | 66 | PH6146066 | SAFETY PIPE |
| 21 | PH6146021 | SEALING RING | 67 | PH6146067 | SAFETY PIPE CASE |
| 22 | PH6146022 | CYLINDER | 68 | PH6146068 | PIN CASE |
| 23 | PH6146023 | BUMPER | 69 | PRP23M | ROLL PIN 4 X 44 |
| 24 | PH6146024 | GASKET | 70 | PH6146070 | PUSHER |
| 25 | PH6146025 | BODY | 71 | PH6146071 | PIN 3 X 20 |
| 26 | PH6146026 | RUBBER WASHER | 72 | PH6146072 | PIN 5 X 20 |
| 27 | PH6146027 | TRIGGER VALVE SEAT | 73 | PSB93M | CAP SCREW M3-.5 X 14 |
| 28 | PH6146028 | O-RING 15 X 2.65 | 74 | PN07M | HEX NUT M3-.5 |
| 29 | PH6146029 | O-RING 17 X 1.5 | 75 | PH6146075 | PIN 4 X 30 |
| 30 | PH6146030 | TRIGGER VALVE GUIDE | 76 | PH6146076 | TORSION SPRING |
| 31 | PH6146031 | O-RING 6.2 X 1.8 | 77 | PH6146077 | SPRING CORE |
| 32 | PH6146032 | O-RING 6.4 X 2 | 78 | PH6146078 | PIN 5 X 12 |
| 33 | PH6146033 | O-RING 9 X 1.8 | 79 | PH6146079 | RELEASE LATCH |
| 34 | PH6146034 | SWITCH SPRING | 80 | PH6146080 | TORSION SPRING |
| 35 | PH6146035 | SWITCH PIPE | 81 | PSB38M | CAP SCREW M5-.8 X 25 |
| 36 | PH6146036 | O-RING 2.5 X 1.5 | 82 | PW02M | FLAT WASHER 5MM |
| 37 | PH6146037 | O-RING 20.3 X 2.3 | 83 | PH6146083 | FIXED SEAT |
| 38 | PH6146038 | SWITCH SEAT | 84 | PLN02M | LOCK NUT M5-.8 |
| 39 | PH6146039 | TRIGGER PIN | 85 | PH6146085 | RUBBER HANDLE CASE |
| 40 | PH6146040 | TRIGGER | 86 | PH6146086 | GASKET |
| 42 | PH6146042 | SAFETY SPACER | 87 | PH6146087 | END CAP |
| 43 | PRP02M | ROLL PIN 3 X 16 | 88 | PLW01M | LOCK WASHER 5MM |
| 44 | PH6146044 | SAFETY GUIDE | 89 | PSB15M | CAP SCREW M5-.8 X 20 |
| 45 | PH6146045 | PIN 3 X 25 | 90 | PH6146090 | 1/4" NPT MALE CONNECT |
| 46 | PH6146046 | COMPRESSION SPRING | 91 | PH6146091 | AIR PLUG COVER |
| | | | 92 | PW02M | FLAT WASHER 5MM |

TROUBLESHOOTING

| PROBLEM | CAUSE | ACTION |
|---|---|--|
| Air leaking at trigger valve area. | 1. O-rings in trigger valve housing are damaged. | 1. O-rings must be replaced & operation of safety yoke must be checked. |
| Air leaking between housing and hose. | 1. Loose screws in housing. 2. Damaged O-ring. 3. Loose air fitting. | 1. Tighten screws. 2. Replace O-ring. 3. Tighten air fitting & use teflon tape. |
| Air leaking between housing and cap assembly. | 1. Damaged seal. | 1. Replace damaged seals. |
| Tool skips nails while discharging. | 1. Air leaks. 2. Dirt in nose. 3. Dirt or damage prevents nails from moving freely in magazine. 4. Inadequate air flow to tool. 5. Worn O-ring on piston or lack of lubrication. 6. Damaged O-rings on trigger valve. 7. Worn bumper. 8. Cap seal leaking. | 1. Tighten screws and fittings. 2. Clean nose. 3. Clean magazine and inspect/repair damage. 4. Check fitting, hose, compressor & air pressure. 5. Replace piston O-ring. Lubricate. 6. Replace trigger valve O-rings. 7. Replace bumper. 8. Replace cap seal. |
| Tool runs slowly or has a loss of power. | 1. Nailer is not sufficiently lubricated. 2. Broken spring in cap assembly. 3. Exhaust port in cap is blocked. | 1. Lubricate nailer. 2. Replace spring. 3. Clean or replace damaged internal parts. |
| Fasteners frequently jam the nailer. | 1. Nails are the wrong size. 2. Nails are bent or dirty. 3. Magazine or nose screws are loose. 4. Driver or driver guide are worn or damaged. 5. Nails are wrong angle. | 1. Use correct nails. 2. Use undamaged, clean nails. 3. Tighten magazine. 4. Replace worn or damaged parts. 5. Use correct angle nails. |
| Nailer does not fire. | 1. Nail is jammed in magazine or discharge area. 2. Piston shaft is damaged. 3. Air pressure too low. | 1. Clear nailer magazine or discharge area. 2. Replace piston shaft. 3. Check/increase air pressure. |

WARRANTY AND RETURNS

Grizzly Industrial, Inc. warrants every product it sells for a period of **1 year** to the original purchaser from the date of purchase. This warranty does not apply to defects due directly or indirectly to misuse, abuse, negligence, accidents, repairs or alterations or lack of maintenance. This is Grizzly's sole written warranty and any and all warranties that may be implied by law, including any merchantability or fitness, for any particular purpose, are hereby limited to the duration of this written warranty. We do not warrant or represent that the merchandise complies with the provisions of any law or acts unless the manufacturer so warrants. In no event shall Grizzly's liability under this warranty exceed the purchase price paid for the product and any legal actions brought against Grizzly shall be tried in the State of Washington, County of Whatcom.

We shall in no event be liable for death, injuries to persons or property or for incidental, contingent, special, or consequential damages arising from the use of our products.

To take advantage of this warranty, contact us by mail or phone and give us all the details. We will then issue you a "Return Authorization Number," which must be clearly posted on the outside as well as the inside of the carton. We will not accept any item back without this number. Proof of purchase must accompany the merchandise.

The manufacturers reserve the right to change specifications at any time because they constantly strive to achieve better quality equipment. We make every effort to ensure that our products meet high quality and durability standards and we hope you never need to use this warranty.

Please feel free to write or call us if you have any questions about the machine or the manual.

Grizzly Industrial, Inc.
1203 Lycoming Mall Circle
Muncy, PA 17756
Phone: (570) 546-9663
Fax: (800) 438-5901

E-Mail:
techsupport@grizzly.com

Web Site: <http://www.grizzly.com>

Thank you again for your business and continued support. We hope to serve you again soon!

WARRANTY CARD

Name _____

Street _____

City _____ State _____ Zip _____

Phone Number _____ E-Mail _____ FAX _____

Model # H6146 34° Clipped Head Framing Nailer Serial# _____ Order # _____

The following information is given on a voluntary basis. It will be used for marketing purposes to help us develop better products and services. Of course, all information is strictly confidential.

- How did you learn about us?
 Advertisement Friend
 Catalog Card Deck
 World Wide Web
 Other _____
- What is your annual household income?
 \$20,000-\$29,999 \$60,000-\$69,999
 \$30,000-\$39,999 \$70,000-\$79,999
 \$40,000-\$49,999 \$80,000-\$89,999
 \$50,000-\$59,999 \$90,000 +
- What is your age group?
 20-29 50-59
 30-39 60-69
 40-49 70 +
- How long have you been a woodworker?
 0 - 2 Years 8 - 20 Years
 2 - 8 Years 20+ Years
- How would you rank your woodworking skills?
 Simple Advanced
 Intermediate Master Craftsman
- What stationary woodworking tools do you own?
Check all that apply.
 Air Compressor Panel Saw
 Band Saw Planer
 Drill Press Power Feeder
 Drum Sander Radial Arm Saw
 Dust Collector Shaper
 Spindle Sander Jointer
 Table Saw Lathe
 Mortiser Wide Belt Sander
 Horiz.Boring Machine
 Vacuum Veneer Press
 Other _____
- How many of your woodworking machines are Grizzly? _____
- Which benchtop tools do you own? Check all that apply.
 1"x42" Belt Sander 6" - 8" Grinder
 5" - 8" Drill Press Mini Lathe
 8" Table Saw 8" - 10" Bandsaw
 Scroll Saw Disc/Belt Sander
 Spindle/Belt Sander Mini Jointer
 10"-12"Thickness Planer
- Other _____
- How many of the machines checked above are Grizzly? _____
- Which portable/hand held power tools do you own?
Check all that apply.
 Belt Sander Orbital Sander
 Biscuit Joiner Palm Sander
 Circular Saw Portable Planer
 Detail Sander Saber Saw
 Drill/Driver Reciprocating Saw
 Miter Saw Router
Other _____
- What machines/supplies would you like Grizzly Industrial to carry?

- What new accessories would you like Grizzly Industrial to carry?

- What other companies do you purchase your tools and supplies from?

- Do you think your purchase represents good value?
 Yes No
- Would you recommend Grizzly to a friend?
 Yes No
- Would you allow us to use your name as a reference for Grizzly customers in your area? **Note: We never use names more than three times.**
 Yes No
- Comments: _____

Send a Grizzly Catalog to a friend:

| |
|----------------------------------|
| Name _____ |
| Street _____ |
| City _____ State _____ Zip _____ |

FOLD ALONG DOTTED LINE



Place
Stamp
Here



GRIZZLY INDUSTRIAL, INC.
P.O. BOX 2069
BELLINGHAM, WA 98227-2069



TAPE ALONG EDGES--PLEASE DO NOT STAPLE

Free Manuals Download Website

<http://myh66.com>

<http://usermanuals.us>

<http://www.somanuals.com>

<http://www.4manuals.cc>

<http://www.manual-lib.com>

<http://www.404manual.com>

<http://www.luxmanual.com>

<http://aubethermostatmanual.com>

Golf course search by state

<http://golfingnear.com>

Email search by domain

<http://emailbydomain.com>

Auto manuals search

<http://auto.somanuals.com>

TV manuals search

<http://tv.somanuals.com>