

Grizzly Industrial, Inc.®

3-IN-1 WOOD, METAL & CONCRETE NAILER

MODEL H2910

INSTRUCTION MANUAL



COPYRIGHT © JANUARY, 2002 BY GRIZZLY INDUSTRIAL, INC.
1821 VALENCIA ST., BELLINGHAM, WA 98227

**WARNING: NO PORTION OF THIS MANUAL MAY BE REPRODUCED IN ANY SHAPE
OR FORM WITHOUT THE WRITTEN APPROVAL OF GRIZZLY INDUSTRIAL, INC.**

PRINTED IN TAIWAN

SAFETY

WARNING

For Your Own Safety Read Instruction Manual Before Operating This Equipment

The purpose of safety symbols is to attract your attention to possible hazardous conditions. This manual uses a series of symbols and signal words which are intended to convey the level of importance of the safety messages. The progression of symbols is described below. Remember that safety messages by themselves do not eliminate danger and are not a substitute for proper accident prevention measures.



Indicates an imminently hazardous situation which, if not avoided, WILL result in death or serious injury.



Indicates a potentially hazardous situation which, if not avoided, COULD result in death or serious injury.



Indicates a potentially hazardous situation which, if not avoided, MAY result in minor or moderate injury. It may also be used to alert against unsafe practices.



This symbol is used to alert the user to useful information about proper operation of the equipment.

WARNING

Safety Instructions For Power Tools

1. **KEEP ALL SAFETY DEVICES IN PLACE** and in working order.
2. **REMOVE ADJUSTING KEYS AND WRENCHES.** Form habit of checking to see that keys and adjusting wrenches are removed from tool before operation.
3. **KEEP WORK AREA CLEAN.** Cluttered areas and benches invite accidents.
4. **DO NOT USE IN DANGEROUS ENVIRONMENT.** Do not use power tools in damp or wet locations, or where any flammable or noxious fumes may exist. Keep work area well lighted.
5. **KEEP CHILDREN AND VISITORS AWAY.** All children and visitors should be kept a safe distance from work area.
6. **MAKE WORKSHOP CHILD PROOF** with padlocks, master switches, or by removing starter keys.
7. **DO NOT FORCE TOOL.** It will do the job better and safer at the rate for which it was designed.
8. **USE THE RIGHT TOOL.** Do not force tool or attachment to do a job for which it was not designed.
9. **DO NOT USE UNDER THE INFLUENCE OF DRUGS OR ALCOHOL.**

WARNING

Safety Instructions For Power Tools

- 10. USE PROPER EXTENSION CORD** for the tool. Make sure your extension cord is in good condition. Conductor size should be in accordance with the chart below. The amperage rating should be listed on the motor or tool nameplate. An undersized cord will cause a drop in line voltage resulting in loss of power and overheating. Your extension cord must also contain a ground wire and plug pin. Always repair or replace extension cords if they become damaged.

Minimum Gauge for Extension Cords

AMP RATING	LENGTH		
	25ft	50ft	100ft
0-6	18	16	16
7-10	18	16	14
11-12	16	16	14
13-16	14	12	12
17-20	12	12	10
21-30	10	10	No

- 15. MAINTAIN TOOLS WITH CARE.** Keep tools sharp and clean for best and safest performance. Follow instructions for lubricating and changing accessories.
- 16. DISCONNECT TOOLS** before servicing and changing accessories.
- 17. REDUCE THE RISK OF UNINTENTIONAL STARTING.** Make sure switch is in off position before plugging in.
- 18. USE THE RECOMMENDED ACCESSORIES.** Consult the owner's manual for recommended accessories. The use of improper accessories may cause risk of injury.
- 19. CHECK DAMAGED PARTS.** Before further use of the tool, a guard or other part that is damaged should be carefully checked to determine that it will operate properly and perform its intended function. Check for alignment of moving parts, binding of moving parts, breakage of parts, mounting, and any other conditions that may affect its operation. A guard or other part that is damaged should be properly repaired or replaced.
- 20. NEVER LEAVE TOOL RUNNING UNATTENDED.** Turn the power off, and do not leave tool until it comes to a complete stop.
- 21. NEVER ALLOW UNTRAINED USERS TO RUN THIS TOOL WHILE UNSUPERVISED.**
- 22. IF YOU ARE UNSURE OF THE INTENDED OPERATION, STOP USING THE TOOL.** Seek formal training or research books or magazines that specialize in power tools.
- 11. WEAR PROPER APPAREL.** Do not wear loose clothing, gloves, neckties, rings, bracelets, or other jewelry which may get caught in moving parts. Non-slip footwear is recommended. Wear protective hair covering to contain long hair.
- 12. ALWAYS USE SAFETY GLASSES.** Also use face or dust mask if cutting operation is dusty. Everyday eyeglasses only have impact resistant lenses, they are NOT safety glasses.
- 13. SECURE WORK.** Use clamps or a vise to hold work when practical. It is safer than using your hand and frees both hands to operate tool.
- 14. DO NOT OVERREACH.** Keep proper footing and balance at all times.

! WARNING

Basic Nailer Safety

In addition to the rules stated in the previous section, and those in the warning boxes throughout this manual, please observe the following safety tips for your new nailer:

1. **READ THIS ENTIRE MANUAL BEFORE OPERATING THE NAILER.**
2. **ALWAYS DISCONNECT AIR FROM THE NAILER** whenever servicing or installing nails. During maintenance, a nailer connected to air may fire accidentally, causing serious personal injury.
3. **DO NOT PLACE HANDS NEAR NAIL POINT OF ENTRY.** Nails can deflect and tear through the surface of the workpiece, puncturing your hand or fingers.
4. **NEVER CONNECT THE NAILER TO PRESSURIZED OXYGEN OR OTHER COMBUSTIBLE GASES** as a power source. Only use filtered, lubricated, and regulated compressed air.
5. **NEVER USE GASOLINE OR OTHER FLAMMABLE LIQUIDS TO CLEAN THE NAILER.** Vapors in the tool will ignite by a spark and cause the tool to explode.
6. **DO NOT CARRY THE NAILER BY ANY OTHER PART THAN THE HANDLE,** and do not carry the nailer by the air hose.
7. **DO NOT KEEP THE TRIGGER PULLED ON THE SAFETY YOKE MECHANISM WHEN CARRYING OR HOLDING THE TOOL.**
8. **DO NOT USE A CHECK VALVE OR ANY OTHER FITTING** that allows air to remain in the tool.

! WARNING

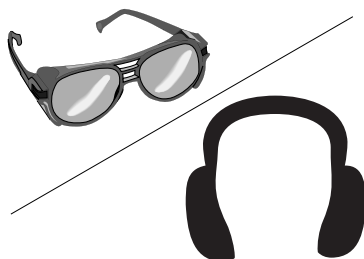

Operating the nailer can propel objects into the air, causing immediate eye damage. To protect yourself, always wear American National Standards Institute (ANSI) approved safety glasses or goggles when operating this equipment. In addition, the nailer discharges at 85-90 decibels. To protect your hearing, always wear ANSI approved ear protection when operating this tool.

! WARNING



Never point the nailer at yourself or another person! Always pay attention to the direction the nailer is pointed. Use this tool with respect and caution to lessen the possibility of operator or bystander injury. Ignoring this warning may result in serious personal injury.

INTRODUCTION

Commentary

We are proud to offer the Grizzly Model H2910 3-IN-1 Wood, Metal & Concrete Nailer. This model is part of a growing Grizzly family of fine power tools. When used according to the guidelines set forth in this manual, you can expect years of trouble-free, enjoyable operation and proof of Grizzly's commitment to customer satisfaction.

The Model H2910 features 360° adjustable exhaust, a convenient bottom-loading magazine, a safety trigger and a durable plastic carrying case.

We are pleased to provide this manual with the Model H2910. It was written to encourage safety considerations and guide you through general operating procedures and maintenance. This manual represents our effort to produce the best documentation possible.

The specifications, details, and photographs in this manual represent the Model H2910 as supplied when the manual was prepared. However, owing to Grizzly's policy of continuous improvement, changes may be made at any time with no obligation on the part of Grizzly. If you have any comments regarding this manual, please write to us at the address below:

Grizzly Industrial, Inc.
% Technical Documentation
P.O. Box 2069
Bellingham, WA 98227-2069

Most importantly, we stand behind our tools. If you have any service questions or parts requests, please call or write us at the location listed below.

Grizzly Industrial, Inc.
1203 Lycoming Mall Circle
Muncy, PA 17756
Phone: (570) 546-9663
Fax: (800) 438-5901
E-Mail: techsupport@grizzly.com
Web Site: <http://www.grizzly.com>

! WARNING

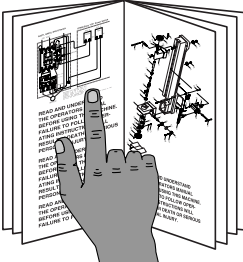

Read the manual before assembly and operation. Become familiar with this tool, its safety instructions, and its operation before beginning any work. Serious personal injury may result if safety or operational information is not understood or followed.

Compressed Air System

The Model H2910 is designed to be operated at 60-100 psi. **Do not exceed the maximum operating pressure for your model.**

Before you use your new nailer, install the $\frac{3}{8}$ " quick connect fitting that comes with the nailer. Install a female $\frac{3}{8}$ " fitting on the air hose. Regulate the air pressure on your air compressor to barely over the minimum psi for your model.

Many pneumatic tools benefit from an in-line filter/lubricator/regulator unit. This attachment is connected by hoses between the air compressor and the stapler. Using this unit protects your tool from damaging water build-up, allows you to adjust and maintain constant air pressure to your tool, and saves you the inconvenience of having to manually lubricate your tool every time you use it. Check the current Grizzly catalog for availability of this unit. If you plan on installing a filter/lubricator/regulator unit in your compressed air system, always follow the connection instructions that come with the unit.

WARNING

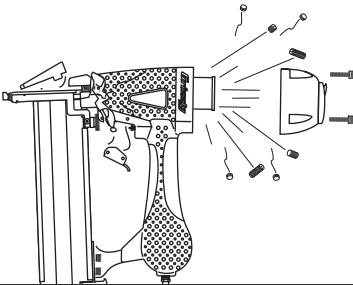

Exceeding the maximum permissible operating pressure may cause the nailer to explode, blowing metal fragments in all directions. To protect yourself from serious personal injury, DO NOT allow your air compressor to exceed the recommended pressure when connected to the nailer!

Safety Yoke Mechanism

A safety yoke mechanism (bump fire) on the nose of the nailer acts as a secondary safety device. When the trigger is pressed, the nailer will not fire until the safety yoke mechanism is depressed.

Before you use your nailer for the first time, check the safety yoke mechanism to ensure proper function. To do this:

1. **Make sure the nailer is disconnected from the air supply!**
2. Make sure the magazine is empty and contains no nails.
3. Make sure the trigger and the safety yoke mechanism move up and down without sticking.
4. Connect the nailer to the air supply.
5. **Without pressing the trigger**, depress the safety yoke mechanism against a scrap piece of wood that is clean and free of any knots, staples, or other foreign objects. If the nailer does not fire, then the safety yoke mechanism is working correctly. If the nailer **does fire** when you do this, immediately disconnect the nailer from the air supply and call our customer service for help.

Similarly if the nailer fires when the trigger is pulled, **without the safety yoke mechanism being depressed**, then the nailer is not working properly.

If either of these two conditions develop after you have used your nailer for a period of time, check the lubrication of these mechanisms.

WARNING

The safety yoke is a mechanical device that can fail. Never rely on the safety yoke mechanism as an excuse to point the tool at yourself or any bystanders. Serious injury may occur.

OPERATION

Loading The Nailer

To load your nailer:

1. **Disconnect the air supply from the nailer!**
2. Push the magazine latch in the direction shown in **Figure 1**.

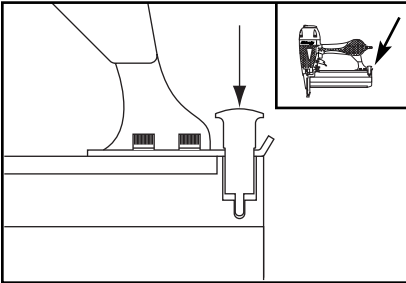

Figure 1. Releasing magazine latch.

3. Pull back the magazine cover until it stops.
4. Point the nailer down and insert a stick of brad nails into the magazine as shown in **Figure 2**. Make sure that the pointed ends of the nails rest in the slot at the bottom of the magazine.

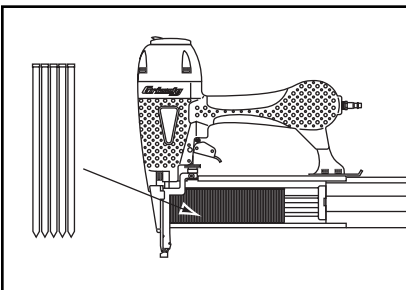

Figure 2. Loading the nailer.

5. Push the magazine cover forward until the magazine latch locks in place.

Depth Adjustment

1. Rotate the depth adjustment wheel (shown in **Figure 3**) clockwise to increase the nail driving depth.
2. Rotate the finger wheel counter-clockwise to decrease the nail driving depth.

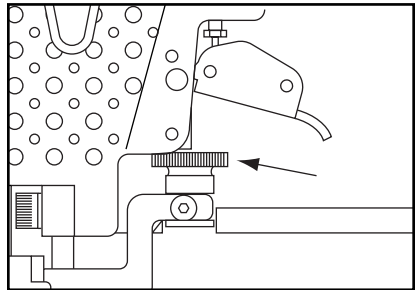

Figure 3. Depth adjustment wheel.

Operating The Nailer

If you have not read the safety instructions in this manual, do not operate the nailer.

Before you operate your nailer, place one drop of the included oil into the quick connect fitting where the nailer connects to the air supply. Fire the EMPTY nailer 3-4 times before beginning, so oil does not come out onto the project during regular operation.

To operate your nailer:

1. Connect the air supply to the quick connect fitting.
2. Test the loaded nailer for proper penetration. Hold the nailer perpendicular to the surface of a piece of clean scrap wood that is thick enough for the length of nails you have loaded. Depress the safety yoke mechanism on your workpiece.
3. Before pressing the trigger, make sure your free hand is positioned out of the way of a potential path of a nail in case of deflection. (Deflection is caused when the nail changes its path, resulting in the nail puncturing the surface of the workpiece as shown in **Figure 4.**)

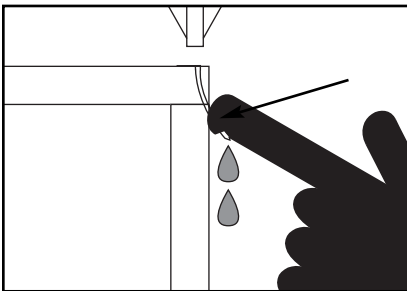

Figure 4. Example of nail deflection.

Besides damaging your workpiece, deflection can cause injury if your free hand is securing the workpiece in the location that the staple/nail deflects.

4. Press the trigger. If the nail drove into the wood far enough, continue with your intended operations. If the nail either went too far or not far enough, then adjust the air pressure. More air pressure will make the nail go deeper and less air pressure will decrease the nail penetration.

Clearing Jammed Nails

The most frequent situation with any type of nailer is a jammed nail. A jam must be cleared before using the nailer again. The two places where a jam can occur is the magazine and the discharge area.

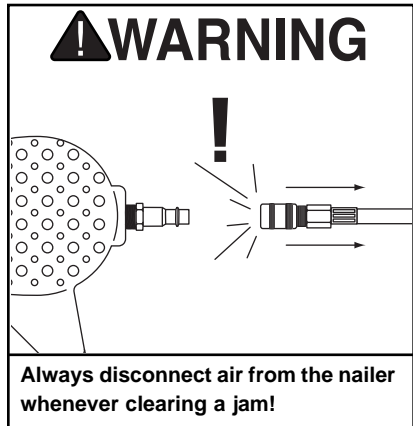

To clear a jam from the magazine:

1. **Disconnect the nailer from the air supply!**
2. Open the magazine cover and pull the magazine all the way back.
3. Locate and remove the jammed nail with a pair of needle nose pliers. Close the magazine cover so it latches.

To clear a jam from the discharge area:

1. **Disconnect the nailer from the air supply!**
2. Remove all of the nails from the magazine.
3. The jammed nail should now be visible; remove it from the discharge area with needle nose pliers.
4. Replace the nails. Push the magazine closed and snap the quick release latch back into operating position.

Oiling The Nailer

Special oil has been included with your new Grizzly nailer to help maintain its useful life. Place one drop of oil in the nailer air inlet (as shown in **Figure 5**) before every use. Wipe off any excess oil near the nailer exhaust to avoid dust build-up. When the oil that was included with the nailer has been completely used, replace with Grizzly Model G2820 Pneumatic Tool Oil.

Another option to manual oiling would be to install a lubricator in your air compressor line. If your air compressor line already has a lubricator, then regular lubrication of your nailer will not be necessary. Just make sure there is always oil in the lubricator.

As mentioned before, the best option is to install a filter/lubricator/regulator unit such as the Grizzly Model H2333 in your air line.

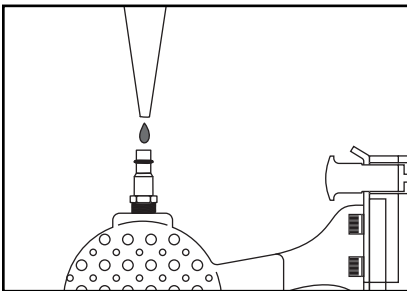

Figure 5. Lubricating the nailer via air inlet.

Cleaning The Nailer

Use a good solvent to clean the nose assembly of the nailer. Always be sure that the nailer is dry before using it again.

Do not allow dust, chips, sand, etc. into the air connectors or into the body of the nailer; this may result in leaks and damage to the nailer and the air couplings.



Never use gasoline or other flammable liquids to clean this tool. Vapors in the tool may ignite, causing the tool to explode. Ignoring this warning may lead to serious personal injury or even death!

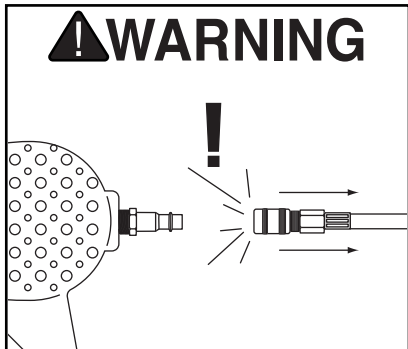

Always disconnect air from the nailer whenever servicing! During maintenance, a nailer connected to air may fire accidentally, causing serious personal injury!

Replacing Pistons/O-Rings

If you use your nailer day in and day out, Grizzly offers repair pistons as cheap insurance against wasted down time and lost profits in the event that a piston or piston shaft becomes worn out. To replace a piston:

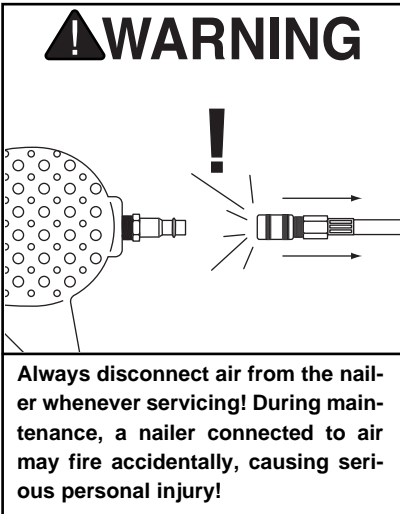

1. **Disconnect the nailer from the air supply!**
2. Remove all nails from the magazine cartridge.
3. Remove the 4 cap screws from the exhaust cap.
4. Remove the exhaust cap as shown in **Figure 6**.
5. The top of the piston should now be visible inside the cylinder, which is housed in the head.
6. Open the magazine.
7. Watch the discharge area and push the top of the piston with your finger. You will see the piston shaft slide down the discharge area.

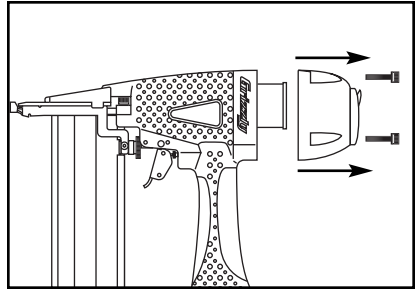
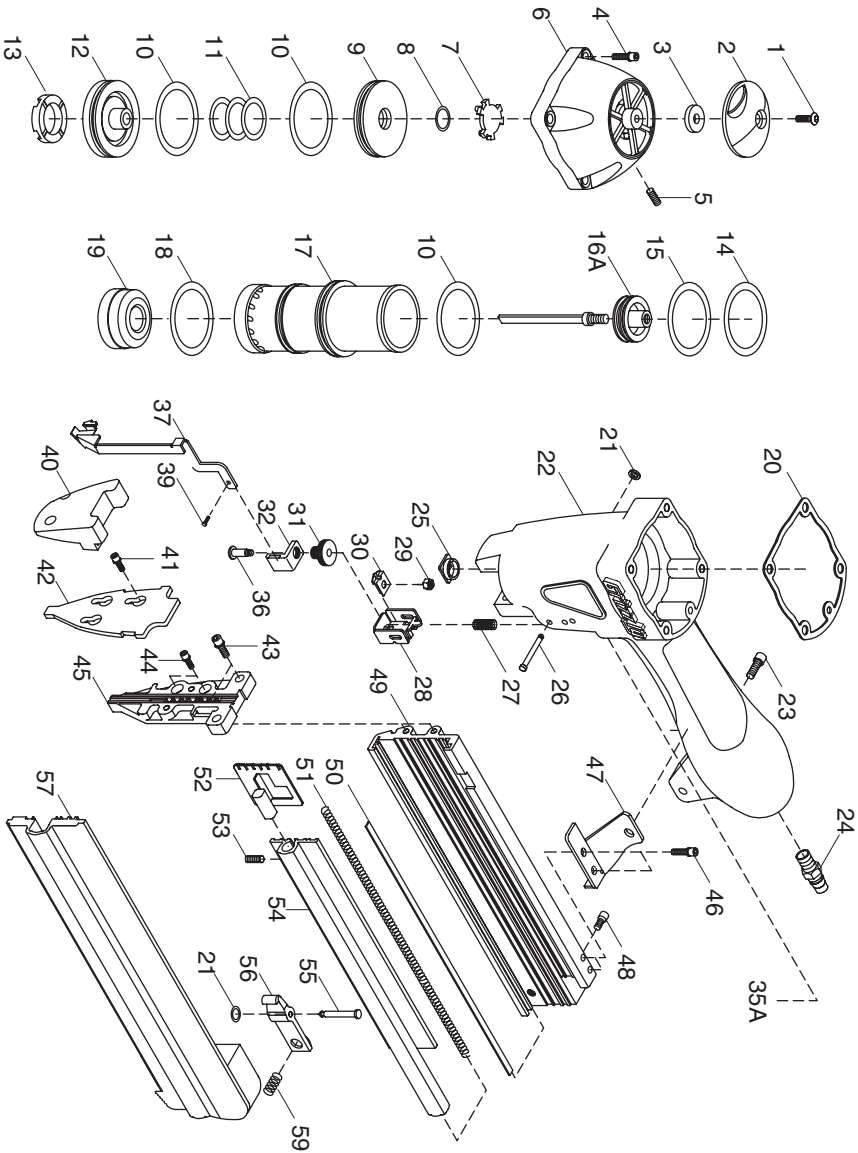

Figure 6. Removing the exhaust cap.

8. With a long flathead screwdriver or similarly shaped tool, push the piston shaft back inside the nailer until you can grip the piston head and remove it from the cylinder. (Be careful not to scratch the discharge area when pushing the piston shaft with the screwdriver.)
9. Place a new O-ring on the new piston and apply a thin film of lubricating oil on the O-ring.
10. Insert the new piston in the cylinder. Make sure that the grooves on the piston shaft line up with those on the guide. The new piston should easily slide into the cylinder. **Do not force the piston into the cylinder!** If the piston is not easily inserted, double-check the alignment of the piston shaft with the grooves on the guide.
11. After the piston is inserted correctly, close the magazine. Replace the rear cap assembly and tighten the 4 cap screws.
12. For more assistance, or to install a complete O-ring set, refer to the appropriate breakdown diagram in the back of this manual.

H2910 PART BREAKDOWN



REF	PART #	DESCRIPTION
01	PH2910001	CAP SCREW
02	PH2910002	CAP COVER
03	PH2910003	SEAL
04	PH2910004	CAP SCREW
05	PH2910005	SETSCREW
06	PH2910006	CAP
07	PH2910007	PISTON STOPPER
08	PH2910008	O-RING
09	PH2910009	COLLAR
10	PH2910010	O-RING
11	PH2910011	SPRING
12	PH2910012	PISTON HEAD VALVE
13	PH2910013	O-RING
14	PH2910014	O-RING
15	PH2910015	O-RING
16A	PH2910016A	PISTON ASSEMBLY
17	PH2910017	CYLINDER
18	PH2910018	O-RING
19	PH2910019	BUMPER
20	PH2910020	GASKET
21	PH2910021	O-RING
22	PH2910022	BODY
23	PH2910023	CAP SCREW
24	PH2910024	AIR PLUG
25	PH2910025	JOINT GUIDE
26	PH2910026	STEPPED PIN
27	PH2910027	SPRING
28	PH2910028	SAFETY LEVER

REF	PART #	DESCRIPTION
29	PH2910029	LOCK NUT
30	PH2910030	POSITIONING PLATE
31	PH2910031	ADJUSTMENT NUT
32	PH2910032	GUIDE PLATE
35A	PH2910035A	BUMP FIRE SWITCH
36	PH2910036	SET SHAFT
37	PH2910037	SAFETY LEVER
38	PH2910038	LOCK WASHER
39	PH2910039	CAP SCREW
40	PH2910040	RUBBER PAD
41	PH2910041	CAP SCREW
42	PH2910042	DIVER GUIDE COVER
43	PH2910043	CAP SCREW
44	PH2910044	CAP SCREW
45	PH2910045	NOSE
47	PH2910047	BRACKET
48	PH2910048	CAP SCREW
49	PH2910049	MAGAZINE
50	PH2910050	NAIL GUIDE LINER
51	PH2910051	SPRING
52	PH2910052	PUSHER
53	PH2910053	SET SCREW
54	PH2910054	MAGAZINE COVER
55	PH2910055	ROLLED PIN
56	PH2910056	STOPPER
57	PH2910057	MAGAZINE COVER
59	PH2910059	SPRING

TROUBLESHOOTING

PROBLEM	CAUSE	ACTION
Air leaking at trigger valve area.	1. O-rings in trigger valve housing are damaged.	1. O-rings must be replaced & operation of safety yoke must be checked.
Air leaking between housing and hose.	1. Loose screws in housing. 2. Damaged O-ring. 3. Loose air fitting.	1. Tighten screws. 2. Replace O-ring. 3. Tighten air fitting.
Air leaking between housing and cap assembly.	1. Damaged seal.	1. Replace damaged seals.
Tool skips nails while discharging.	1. Air leaks. 2. Dirt in nose. 3. Dirt or damage prevents nails from moving freely in magazine. 4. Inadequate air flow to tool. 5. Worn O-ring on piston or lack of lubrication. 6. Damaged O-rings on trigger valve. 7. Worn bumper. 8. Cap seal leaking.	1. Tighten screws and fittings. 2. Clean nose. 3. Clean magazine and inspect/repair damage. 4. Check fitting, hose, compressor & air pressure. 5. Replace piston O-ring. Lubricate. 6. Replace trigger valve O-rings. 7. Replace bumper. 8. Replace cap seal.
Tool runs slowly or has a loss of power.	1. Tool is not sufficiently lubricated. 2. Broken spring in cap assembly. 3. Exhaust port in cap is blocked.	1. Lubricate tool. 2. Replace spring. 3. Clean or replace damaged internal parts.
Fasteners frequently jam the tool.	1. Nails are the wrong size. 2. Nails are bent. 3. Magazine or nose screws are loose. 4. Driver or driver guide are worn or damaged.	1. Use correct nails. 2. Use undamaged nails. 3. Tighten magazine and nose screws. 4. Replace worn or damaged parts.
Tool does not fire.	1. Nail is jammed in magazine or discharge area. 2. Piston shaft is damaged. 3. Air pressure too low.	1. Clear tool magazine or discharge area. 2. Replace piston shaft. 3. Check/increase air pressure.

WARRANTY AND RETURNS

Grizzly Industrial, Inc. warrants every product it sells for a period of **1 year** to the original purchaser from the date of purchase. This warranty does not apply to defects due directly or indirectly to misuse, abuse, negligence, accidents, repairs or alterations or lack of maintenance. This is Grizzly's sole written warranty and any and all warranties that may be implied by law, including any merchantability or fitness, for any particular purpose, are hereby limited to the duration of this written warranty. We do not warrant or represent that the merchandise complies with the provisions of any law or acts unless the manufacturer so warrants. In no event shall Grizzly's liability under this warranty exceed the purchase price paid for the product and any legal actions brought against Grizzly shall be tried in the State of Washington, County of Whatcom.

We shall in no event be liable for death, injuries to persons or property or for incidental, contingent, special, or consequential damages arising from the use of our products.

To take advantage of this warranty, contact us by mail or phone and give us all the details. We will then issue you a "Return Authorization Number," which must be clearly posted on the outside as well as the inside of the carton. We will not accept any item back without this number. Proof of purchase must accompany the merchandise.

The manufacturers reserve the right to change specifications at any time because they constantly strive to achieve better quality equipment. We make every effort to ensure that our products meet high quality and durability standards and we hope you never need to use this warranty.

Please feel free to write or call us if you have any questions about the machine or the manual.

Grizzly Industrial, Inc.
1203 Lycoming Mall Circle
Muncy, PA 17756
Phone: (570) 546-9663
Fax: (800) 438-5901

E-Mail:
techsupport@grizzly.com

Web Site: <http://www.grizzly.com>

Thank you again for your business and continued support. We hope to serve you again soon!

WARRANTY CARD

Name _____

Street _____

City _____ State _____ Zip _____

Phone Number _____ E-Mail _____ FAX _____

Model # _____ Order # _____

The following information is given on a voluntary basis. It will be used for marketing purposes to help us develop better products and services. Of course, all information is strictly confidential.

- How did you learn about us?
 Advertisement Friend
 Catalog Card Deck
 World Wide Web
 Other _____
- What is your annual household income?
 \$20,000-\$29,999 \$60,000-\$69,999
 \$30,000-\$39,999 \$70,000-\$79,999
 \$40,000-\$49,999 \$80,000-\$89,999
 \$50,000-\$59,999 \$90,000 +
- What is your age group?
 20-29 50-59
 30-39 60-69
 40-49 70 +
- How long have you been a woodworker?
 0 - 2 Years 8 - 20 Years
 2 - 8 Years 20+ Years
- How would you rank your woodworking skills?
 Simple Advanced
 Intermediate Master Craftsman
- What stationary woodworking tools do you own?
Check all that apply.
 Air Compressor Panel Saw
 Band Saw Planer
 Drill Press Power Feeder
 Drum Sander Radial Arm Saw
 Dust Collector Shaper
 Spindle Sander Jointer
 Table Saw Lathe
 Mortiser Wide Belt Sander
 Horiz.Boring Machine
 Vacuum Veneer Press
 Other _____
- How many of your woodworking machines are Grizzly? _____
- Which benchtop tools do you own? Check all that apply.
 1"x42" Belt Sander 6" - 8" Grinder
 5" - 8" Drill Press Mini Lathe
 8" Table Saw 8" - 10" Bandsaw
 Scroll Saw Disc/Belt Sander
 Spindle/Belt Sander Mini Jointer
 10"-12"Thickness Planer
 Other _____
- How many of the machines checked above are Grizzly? _____
- Which portable/hand held power tools do you own? Check all that apply.
 Belt Sander Orbital Sander
 Biscuit Joiner Palm Sander
 Circular Saw Portable Planer
 Detail Sander Saber Saw
 Drill/Driver Reciprocating Saw
 Miter Saw Router
 Other _____
- What machines/supplies would you like Grizzly Industrial to carry?

- What new accessories would you like Grizzly Industrial to carry?

- What other companies do you purchase your tools and supplies from?

- Do you think your purchase represents good value?
 Yes No
- Would you recommend Grizzly to a friend?
 Yes No
- Would you allow us to use your name as a reference for Grizzly customers in your area? **Note: We never use names more than three times.**
 Yes No
- Comments: _____

Send a Grizzly Catalog to a friend:

Name_____
Street_____
City_____State_____Zip_____

FOLD ALONG DOTTED LINE

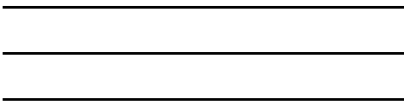

Place
Stamp
Here



GRIZZLY INDUSTRIAL, INC.
P.O. BOX 2069
BELLINGHAM, WA 98227-2069



TAPE ALONG EDGES--PLEASE DO NOT X

Free Manuals Download Website

<http://myh66.com>

<http://usermanuals.us>

<http://www.somanuals.com>

<http://www.4manuals.cc>

<http://www.manual-lib.com>

<http://www.404manual.com>

<http://www.luxmanual.com>

<http://aubethermostatmanual.com>

Golf course search by state

<http://golfingnear.com>

Email search by domain

<http://emailbydomain.com>

Auto manuals search

<http://auto.somanuals.com>

TV manuals search

<http://tv.somanuals.com>