

# *Grizzly* *Industrial, Inc.*®

## MODEL H8069 HEIRLOOM STRATOCASTER- STYLE GUITAR KIT OWNER'S MANUAL



*Stratocaster® is a registered trademark of Fender Musical Instruments Corp.  
This kit is not made or sponsored by Fender Musical Instruments Corp.*

COPYRIGHT © DECEMBER, 2006 BY GRIZZLY INDUSTRIAL, INC.  
**WARNING: NO PORTION OF THIS MANUAL MAY BE REPRODUCED IN ANY SHAPE  
OR FORM WITHOUT THE WRITTEN APPROVAL OF GRIZZLY INDUSTRIAL, INC.**  
#BL8551 PRINTED IN KOREA

 **WARNING!**

**Some dust created by power sanding, sawing, grinding, drilling, and other construction activities contains chemicals known to the State of California to cause cancer, birth defects or other reproductive harm. Some examples of these chemicals are:**

- **Lead from lead-based paints.**
- **Crystalline silica from bricks, cement and other masonry products.**
- **Arsenic and chromium from chemically-treated lumber.**

**Your risk from these exposures varies, depending on how often you do this type of work. To reduce your exposure to these chemicals: Work in a well ventilated area, and work with approved safety equipment, such as those dust masks that are specially designed to filter out microscopic particles.**

# Table of Contents

<b>SECTION 1: SAFETY .....</b>	<b>2</b>
<b>SECTION 2: INTRODUCTION .....</b>	<b>3</b>
Foreword .....	3
Contact Info.....	3
<b>SECTION 3: PARTS INVENTORY .....</b>	<b>4</b>
Parts & Inventory.....	4
Supplies/Tools.....	5
Identification .....	6
<b>SECTION 4: ASSEMBLY .....</b>	<b>7</b>
Peghole Placement .....	7
Shaping Headstock.....	8
Sanding Body.....	9
Sanding Neck.....	9
Finishing Neck.....	10
Finishing Body.....	10
Mounting Tuners .....	11
Pick Guard .....	12
Mounting Neck .....	13
Tremolo Bridge.....	14
Audio Jack.....	15
Strap Buttons .....	16
Mounting Back Plate .....	16
Installing Nut .....	17
Winding Strings .....	17
Mounting Pick Guard.....	18
String Retainers .....	19
<b>SECTION 5: SETUP .....</b>	<b>20</b>
General.....	20
Neck Adjustment.....	20
String Height .....	21
Pickup Height .....	22
Tuning .....	22
Setting Intonation .....	23
Tremolo Adjustment .....	23
<b>SECTION 6: REFERENCE INFO .....</b>	<b>24</b>
Accessories.....	24
Electrical Components .....	28
Wiring Diagram .....	29
<b>WARRANTY AND RETURNS .....</b>	<b>30</b>

# SECTION 1: SAFETY

---

---

## WARNING

Always wear safety glasses or goggles when operating equipment. Everyday glasses or reading glasses are not safety glasses. Be certain the safety glasses you wear meet the appropriate standards of the American National Standards Institute (ANSI).

Because there are various ways to cut and join wood, you can make substitutions for the methods stated in this plan. We try to suggest the easiest methods possible. However, only you know your skills with each piece of machinery. Never compromise your safety by using a cutting method with which you are not comfortable. Instead, find an alternative approach that will yield the same result.

## WARNING

These instructions assume that you are intimately familiar with the safe operation and use of woodworking machinery and woodworking tools, and understand the techniques used to build this project. If you do not qualify for both of these criteria, **STOP building this project for your own safety**. Read and understand the owners manual for the machinery you intend to use, take a woodworking class or visit your local library for more information. Woodworking machinery and tools are inherently dangerous because they use sharp edges that can and will cause serious personal injury including amputation and death. Do not underestimate the ability of these tools and machinery to cause injury. Never operate any tool without all guards in place and always wear approved safety glasses. For your own safety, please heed this warning.

# SECTION 2: INTRODUCTION

---

---

## Foreword

---

---

We are proud to offer the Model H8069 Heirloom Stratocaster-Style Guitar Kit. This kit is part of a growing Grizzly family of fine woodworking products. When assembled according to the guidelines set forth in this manual, you can expect years of enjoyment from your guitar.

We are pleased to provide this manual for the Model H8069. It was written to guide you through assembly, review safety considerations, and cover general information. It represents our effort to produce the best documentation possible.

*Stratocaster® is a registered trademark of Fender Musical Instruments Corp. This kit is not made or sponsored by Fender Musical Instruments Corp.*

## Contact Info

---

---

If you have any comments regarding this manual, please write to us at the address below:

Grizzly Industrial, Inc.  
c/o Technical Documentation Manager  
P.O. Box 2069  
Bellingham, WA 98227-2069  
Email: manuals@grizzly.com

We stand behind our products. If you have any service questions or parts requests, please call or write us at the location listed below.

Grizzly Industrial, Inc.  
1203 Lycoming Mall Circle  
Muncy, PA 17756  
Phone: (570) 546-9663  
Fax: (800) 438-5901  
E-Mail: techsupport@grizzly.com  
Web Site: <http://www.grizzly.com>



# SECTION 3: PARTS INVENTORY

## Parts & Inventory

REF	PART#	DESCRIPTION	QTY
1	PH8069001	Guitar Body	1
2	PH8069002	Neck	1
3	PH8069003	Pick Guard	1
4	PH8069004	Backplate	1
5	PH8069005	Neckplate	1
6	PH8069006	Spring Hanger	1
7	PH8069007	Tremolo Bridge	1
8	PH8069008	Tremolo Spring	4
9	PH8069009	Tremolo Arm	1
10	PH8069010	Audio Jack Plate	1
11	PH8069011	Tuning Machine	6
12	PH8069012	Hex Nut Bushing	6
13	PH8069013	Flat Washer 8mm	6
14	PH8069014	String	6
15	PH8069015	Chrome Screw 5 x 45mm	4
16	PH8069016	Chrome Screw 4 x 40mm	2
17	PH8069017	Chrome Screw 3.5 x 30mm	6
18	PH8069018	Chrome Screw 3.5 x 25mm	2
19	PH8069019	Chrome Screw 3.1 x 12mm	20
20	PH8069020	Chrome Screw 2.5 x 14mm	2
21	PH8069021	Chrome Screw 2.1 x 14mm	6
22	PH8069022	String Retainer	2
23	PH8069023	Bushing 4 x 5 x 3mm	2
24	PH8069024	Nut	1
25	PAW04M	Hex Wrench 4mm	1
26	PAW01.5M	Hex Wrench 1.5mm	1
27	PH8069027	Strap Button	2
28	PH8069028	Audio Jack	1

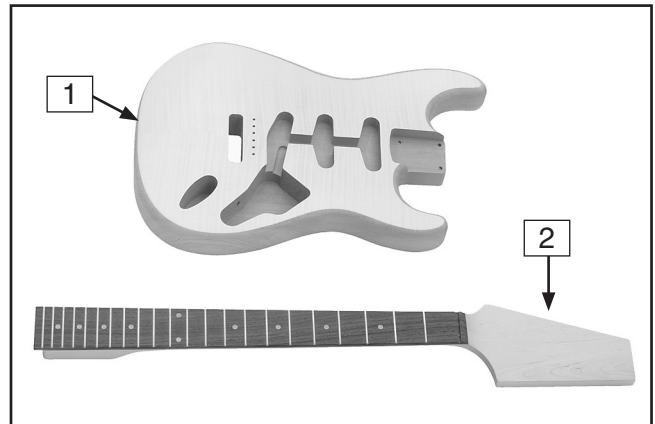

Figure 1. Boxed components.

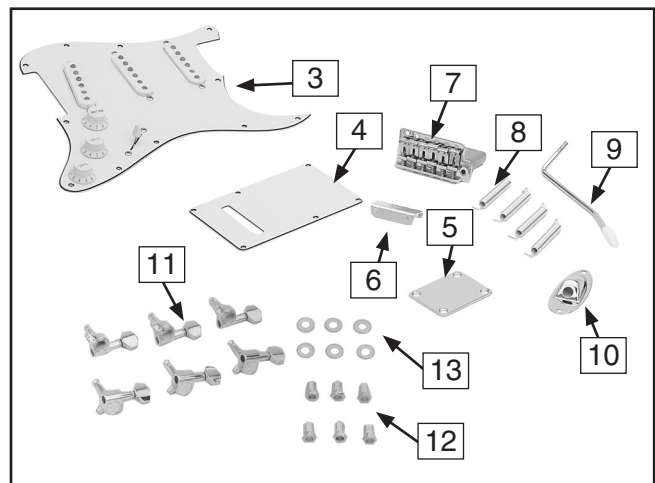

Figure 2. Guitar parts.

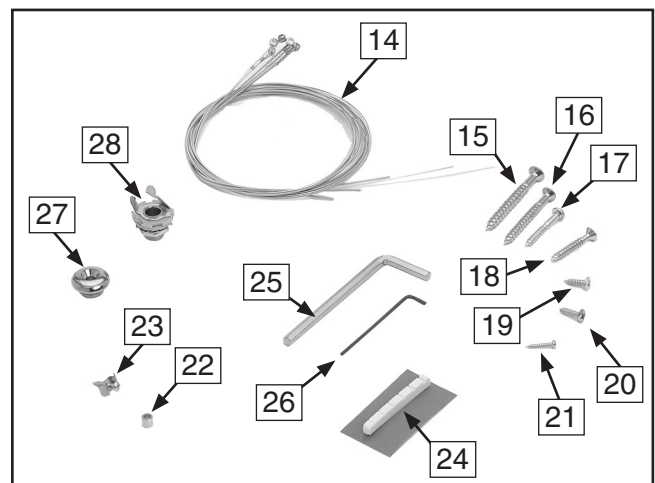

Figure 3. More guitar parts.

# Supplies/Tools

---

---

Most wood components in this kit are fully machined at the factory and are ready for assembly. A small amount of sanding and finishing is needed to complete your guitar.

## Recommended Tools & Supplies:

- Sharp Pencil
- Drill Press
- Drill Bits:  $\frac{1}{16}$ ",  $\frac{3}{32}$ ",  $\frac{9}{64}$ ",  $\frac{5}{32}$ ",  $\frac{5}{16}$ ",  $\frac{25}{64}$ "
- Electric/Cordless Drill
- Depth Stop
- NIOSH Approved Respirator
- ANSI Approved Safety Glasses
- Aluminum-Oxide Sanding Paper #150, #220 and #320 Grit
- Wet/Dry Sanding Paper #400, #600, and #1000 Grit
- Flexible Sanding Block
- Wood Glue
- Chisel or Razor Blade
- Phillips Screwdriver #1, #2
- $\frac{1}{4}$ " Steel Rod or a Coat Hanger
- Masking Tape
- Machinist Square
- Bandsaw with  $\frac{1}{4}$ " Blade or Coping Saw

- Tack Cloth or Soft Cloth
- Sanding Sealer
- Assorted Wood Files
- Buffing Compounds
- Oil Wood Finish
- Soldering Iron and Solder
- Headstock Reamer or a Round File
- Rubber Dead Blow Hammer
- Tweezers, Pliers, Wire Cutters
- C-Clamps
- Temporary Wood Handle:  
Approximately 1" x 2" x 16"
- Guitar Capo
- Feeler Gauge Set
- Spray Primer and Finish (See Note Below)
- 18" Metal Straightedge ( $\frac{1}{32}$ " Resolution)
- Steel Ruler ( $\frac{1}{64}$ " Resolution)
- Wood Wedge (Approximately  $\frac{3}{8}$ ")
- Wood Blocks: 2"x4"x6 (3)
- Wood Shim:  $\frac{9}{16}$ " Thick

**Note:** Use the same type of paint for primer and finish—either enamel or lacquer base. Do not use different base paints for priming or finishing or your results may not be desirable.



# Identification

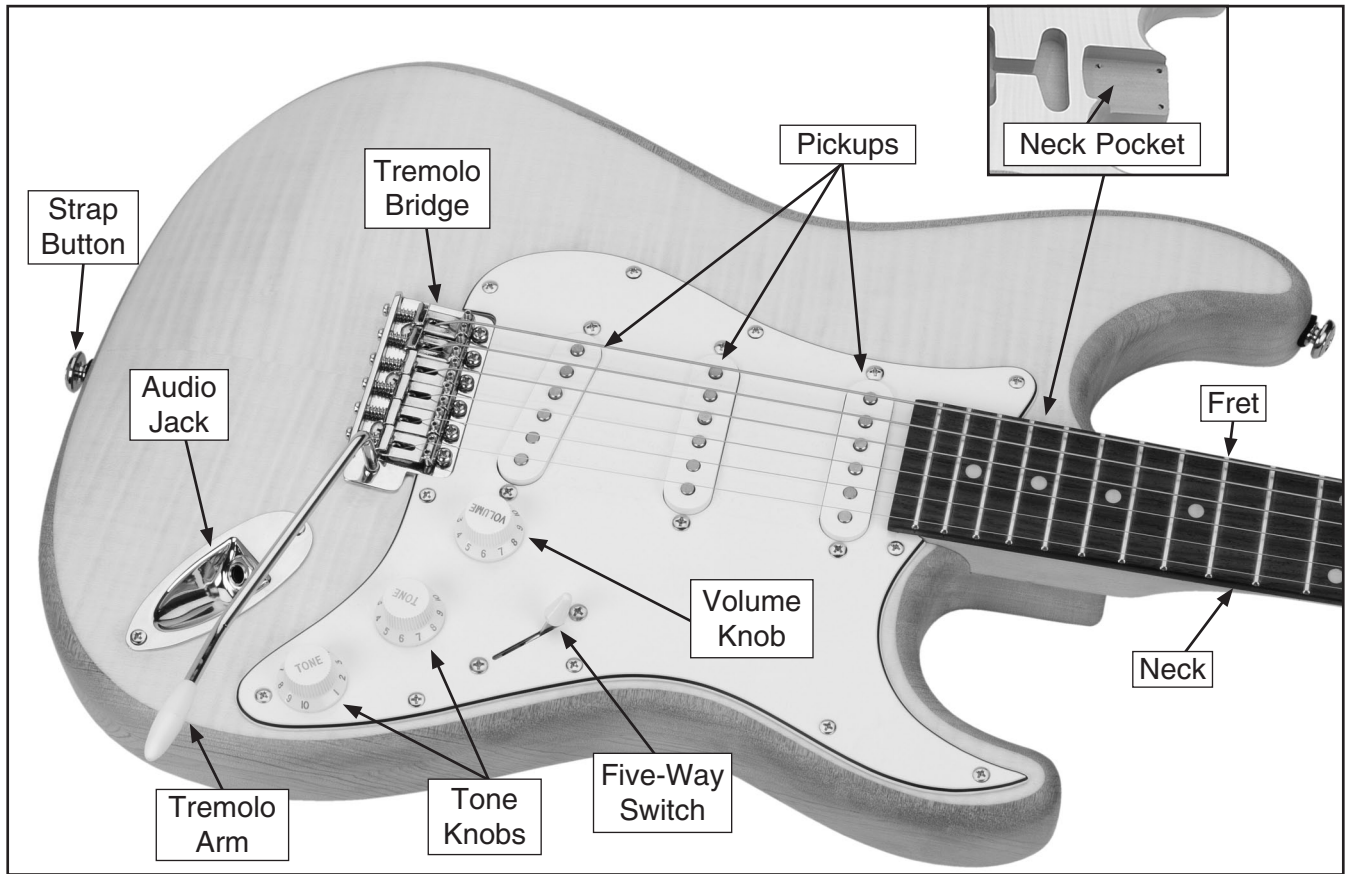

Figure 4. Model H8069 controls.

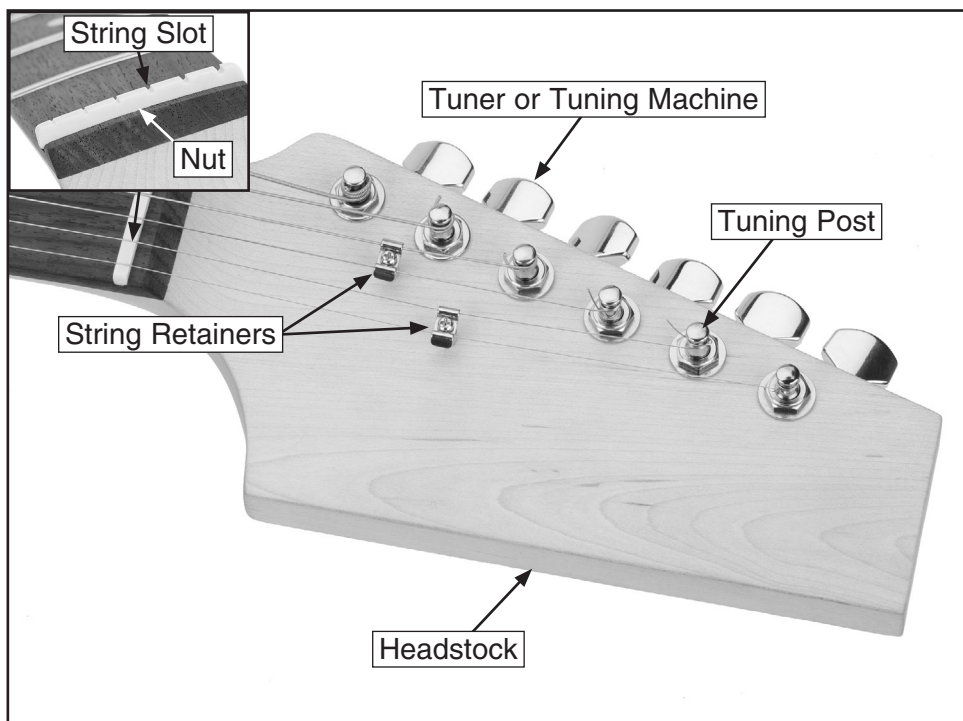

Figure 5. Model H8069 headstock features.





# SECTION 4: ASSEMBLY

## Peghole Placement

The headstock is rough machined to fit all six tuners on one side. These instructions will guide you through the placement of the pegholes. The pegholes must be drilled slightly undersized so that the bushings will be tight. Correct placement of the pegholes will make the tuner installation easier.

We recommend you read through the assembly section to gain an overview of the process before beginning.

Components Needed	Qty
Guitar Neck .....	1

### To drill the pegholes in the headstock:

1. Center the nut in the nut slot and mark the string slots on the fretboard with a pencil. Make sure the larger grooves of the nut are toward the top of the neck.
2. Remove the nut and align the leading edge a machinist's square with either edge of the nut slot. Use a pencil to extend the string slot marks onto the headstock as shown in **Figure 6**.

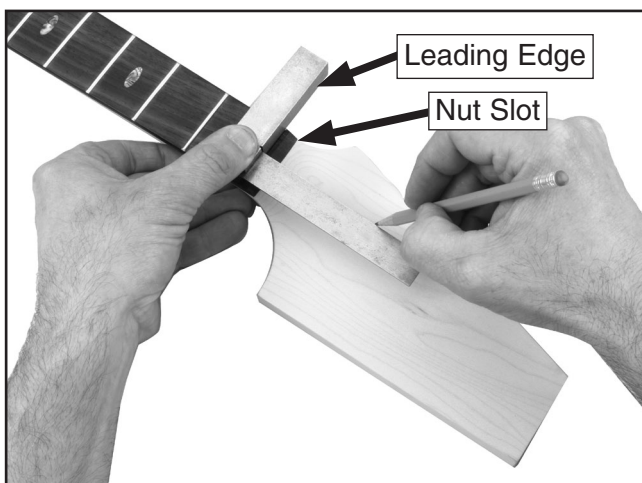

Figure 6. Marking string paths.

3. Make a mark  $1\frac{13}{16}$ " from the fretboard side of the nut slot on line "A" shown in **Figure 7**.

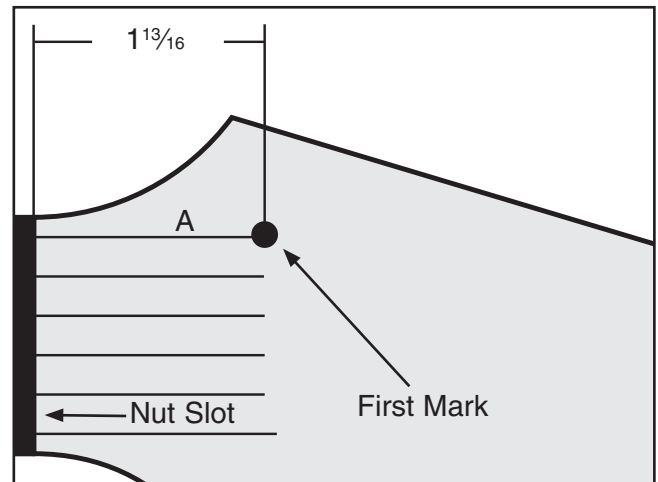

Figure 7. Peghole placement, first mark.

4. Place the machinist square against the angled edge of the headstock and draw a light pencil line through the mark made in **Step 3**.
5. Make a mark on the line made in **Step 4**,  $\frac{1}{4}$ " towards the headstock edge from the line made in **Step 2** as shown in **Figure 8**. This marks the center of the first peghole. This mark should be parallel to and  $\frac{1}{2}$ " from the angled edge of the headstock.

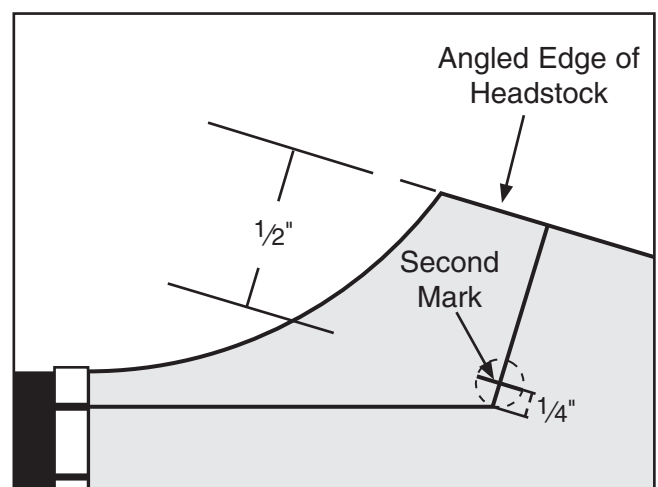
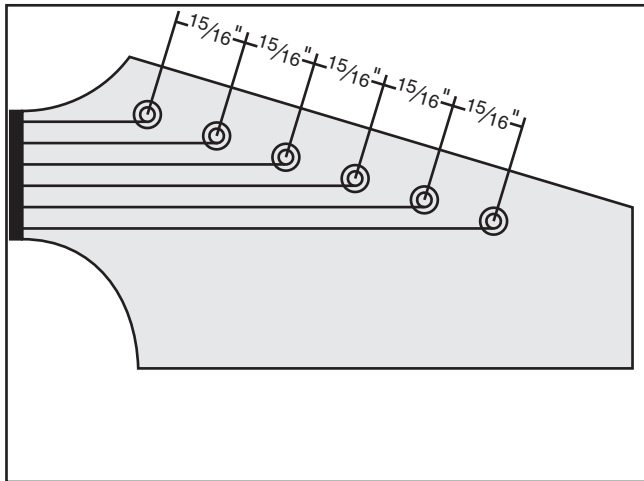

Figure 8. Peghole placement and second mark.



6. Space the centers of the remaining pegholes  $\frac{15}{16}$ " apart, as shown in **Figure 7**, and  $\frac{1}{2}$ " from the edge of the headstock.



**Figure 9.** Peghole spacing.

7. Using a  $\frac{5}{16}$ " bit, drill holes through the top of the headstock for the tuner shafts, as shown in **Figure 10**.

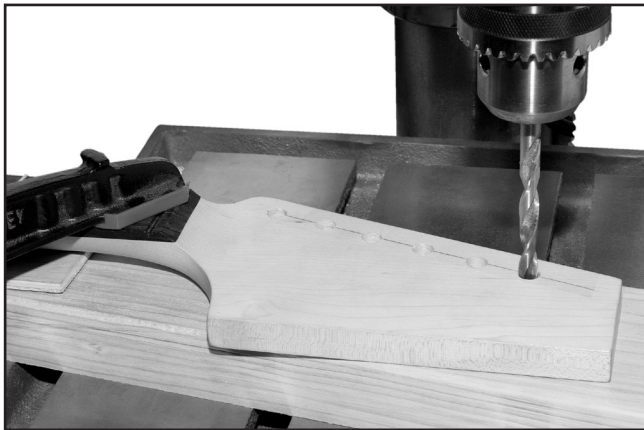

**Figure 10.** Drilling the pegholes.

8. Turn the neck over and fasten a  $\frac{9}{16}$ " thick wood shim with tape on the top side of the headstock and over the tuner holes. This will help stabilize the neck during the next step.
9. Center a  $\frac{25}{64}$ " bit over each hole drilled in **Step 7**, and drill down  $\frac{11}{32}$ " for the base of the tuners.

## Shaping Headstock

After you have drilled the tuner holes, you can cut the unfinished headstock to your own design.

Components Needed	Qty
Guitar Neck .....	1

### To shape the headstock:

1. Trace the headstock on a piece of paper. Test various ideas for headstock shapes on paper before cutting into the headstock.
2. Redraw your final headstock shape onto the headstock with a pencil.
3. Cut the headstock out with a bandsaw or coping saw. Be sure to cut only to the outside edge of your pencil line.

**Note:** To cut sharp corners, cut several slots perpendicular to the corner, then cut out the small pieces. This will reduce binding on the blade.

4. Carefully hand file the headstock to finalize the shape.



# Sanding Body

---

---

The guitar body was sanded at the factory, but it is up to you to do the final sanding before the finish is applied. To get a good finish, the body should be sanded with a series of sandpaper grits up to #320 grit.

Components and Hardware Needed:	Qty
Guitar Body .....	1

## To sand the guitar body:

1. **Wear a NIOSH-approved respirator and ANSI-approved safety glasses when sanding wood!**
2. Use a flexible sanding block with #150 grit aluminum-oxide sanding paper to sand the guitar body until there is a consistent scratch pattern on the entire surface.

**Note:** *DO NOT round over the neck pocket or the body cavities.*

*When hand sanding, always sand in the same direction as the wood grain.*

3. Resand the entire guitar body with #220 grit sanding paper and lightly round over the outside edges of the body.
4. Wipe the guitar body with a damp cloth to "raise" the wood grain.
5. Wait until the wood is dry and resand the entire body with #220 grit sandpaper to sand the "raised" grain smooth.

6. Repeat **Step 4 & 5.**

**Note:** *If you want to stain your guitar, the stain should be applied now before continuing with the next step. Stains cannot be applied to the guitar body after the sanding sealer is applied.*

7. Apply a primer if you plan to paint the guitar a solid color. Apply a coat of sanding sealer now if you desire to see the wood grain or if you stained the guitar. Use the sealer or primer according to the manufacturer's instructions.

**Note:** *Make sure the primer or sealer you use is compatible with your finish.*

8. When the sanding sealer or primer is dry, use #320 grit sandpaper for final sanding. **DO NOT** sand through to bare wood.

# Sanding Neck

---

---

Like the guitar body, the guitar neck was rough sanded at the factory. Final sanding should be done as described in the previous sub-section **Sanding Body**. Consider applying inlays or additional design work on the fretboard and headstock before final sanding.

**Note:** *If you are considering inlays or other design work, take time to test your designs in scrap wood before performing the work on the instrument.*

**DO NOT** sand the fretboard. Sanding the fretboard will affect the playability of the guitar and could lead to irreparable damage.



# Finishing Neck

Finishing options include stains, lacquers, varnishes and oil finishes. Traditionally, this style of guitar has a clear finish on the neck. Finishes can be applied with a spray gun, brush, rag, or a spray can. Finish materials and books on finishing instruments can be ordered through Grizzly Industrial or numerous luthier supply catalogs.

**Components and Hardware Needed:** Qty  
Guitar Neck ..... 1

## To finish the guitar neck:

1. Mask off the surface of the fretboard. Carefully press all the masking tape edges securely to the fretboard. The finish coat can seep under these edges, especially near corners, uneven edges, and places where the frets meet the fingerboard. (It can be a tedious chore to remove finish from the fretboard.)
2. Make an "S" shaped hook out of 1/4" steel rod or a coat hanger that has been folded in half.
3. Wipe the entire neck with a tack cloth to remove any dust.
4. Thread the hook through the upper peghole and hang the neck in the finishing room.

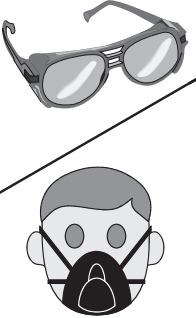
	<p><b>⚠ WARNING</b> Most finishes are hazardous to your health. Wear a NIOSH/OSHA approved respirator with particulate and gas/vapor filters, safety glasses, rubber gloves, and work in a well ventilated area when finishing.</p>
---	---

5. Apply the finish according to **Steps 5–10** on the **Finishing Body** instructions.
6. Before wet sanding, remove the masking tape from the fretboard and carefully scrape any excess finish off the fretboard with a razor blade or chisel held perpendicular to the surface, as shown in **Figure 11**.

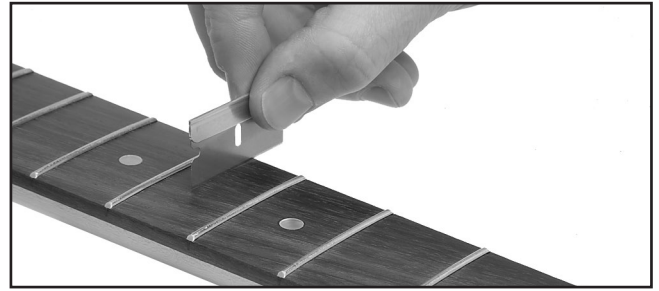

**Figure 11.** Scraping finish off of the fretboard.

7. Let the wood dry naturally and completely.
8. Use a clean rag to wipe wood finishing oil on the dried surface of the fretboard.

# Finishing Body

This guitar looks incredible with a clear finish that highlights the wood grain patterns. The surface can be stained prior to finishing or a transparent pigment can be added to the finish. These instructions guide you through a very basic finishing process. Books describing different guitar finishing techniques are available through luthier supply catalogs or through your local library. Clear finish materials and books on finishing can be ordered through Grizzly Industrial. Finishing a guitar is a difficult task. If you are unsure of your skills; do your research, practice on scrap wood, or take it to a professional.

**Components and Hardware Needed:** Qty  
Guitar Body ..... 1

## To finish the guitar body:

1. Mask off the neck pocket (**Figure 4**). Press the masking tape tight against the edges of the pocket so the finish does not seep under the tape.
2. Screw through the neck pocket screw holes into a long piece of wood to use for a handle during spraying. Drill a hole in the end of the handle for hanging from a hook.
3. Wipe a tack cloth over the entire guitar body to remove dust.
4. Thread the hook through the temporary handle and hang the body in the finish room.



5. Apply several thin coats of the finish, following the manufacturer's instructions. Multiple thin coats usually produce a better quality finish than one heavy coat.
6. Dry sand the entire body with #400 grit wet/dry sandpaper after at least three coats of finish have been applied. DO NOT sand through the finish—be careful on the edges.
7. Use a tack cloth to remove sanding residue.
8. Apply more finish, sanding between coats, until the finish is the desired thickness.

**Note:** *If finishing with a solid color, you may wish to apply several coats of a clear finish over the top, sanding between coats, to add depth to the finish.*

9. When the final coat has dried at least a week, preferably a month, remove the temporary handle and masking.
10. Wet sand the finish using #600 grit wet/dry sandpaper with a sanding block, followed with #1000 grit wet/dry sandpaper.
11. Use a clean, absorbent rag to remove excess water. Let the guitar dry completely, then use a tack cloth to remove all residue.
12. Buff the finish by hand or with a buffer, starting with a medium polish and working up to a high gloss polish.

**Note:** *If you use a buffing machine, be careful to avoid going through the finish, especially on the edges.*

## **NOTICE**

**Dust particles suspended in the air will settle on wet finishes, causing less than satisfactory results. To avoid this problem:**

- **Leave the finishing room undisturbed for 24 hours prior to applying the finish.**
- **Avoid making unnecessary movements when entering the finish room.**
- **Apply the finish to the desired guitar parts and immediately leave the finish room. DO NOT return to the room until the specified drying time has elapsed.**

## **Mounting Tuners**

<b>Components Needed</b>	<b>Qty</b>
Guitar.....	1
Tuners .....	6
Flat Washers 8mm .....	6
Hex Nut Bushings.....	6
Chrome Screws 2.1 X 14mm .....	6

### **To install the tuners:**

1. Place the six tuners into the holes on the back of the headstock. The holes may need to be widened with a peghead reamer or a round file. DO NOT widen the holes too much—the tuners should fit snugly.
2. Slide a washer over the tuner post and screw the hex nut bushing onto the tuner as shown in **Figure 12**.

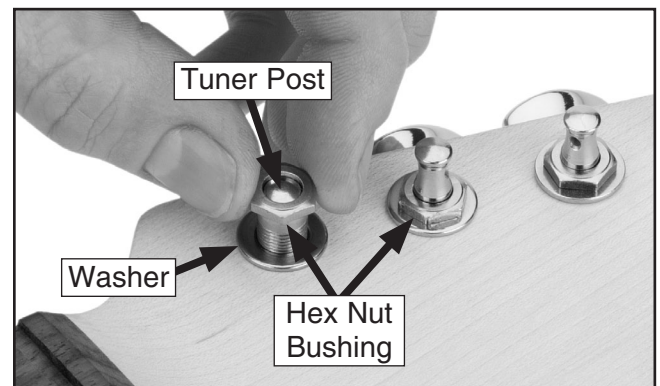

**Figure 12.** Threading hex nut bushing onto tuner.



- Align the tuners perpendicular to the edge of the headstock and parallel to each other as shown in **Figure 13**. Use a strip of masking tape to secure their position on the headstock.

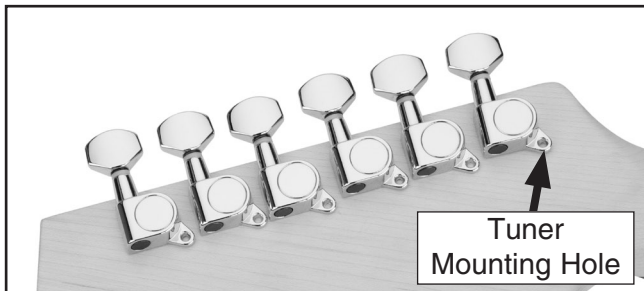

**Figure 13.** Tuners aligned to edge of headstock.

- Using a  $\frac{1}{16}$ " drill bit in a drill press, drill  $\frac{3}{8}$ " deep holes into the back of the headstock through each tuner mounting hole.

**Note:** *Drilling the holes deeper than  $\frac{3}{8}$ " could result in drilling out through the front face of the headstock. Use a depth stop or tape wrapped around the drill bit at the correct depth as an indicator.*

- Secure the tuners to the guitar headstock with the 2.1 x 14mm screws.

## Pick Guard

Components and Hardware Needed:	Qty
Guitar Body .....	1
Pick Guard.....	1

### To attach the pick guard to the guitar body:

- Push the thin black ground wire through the hole that leads to the cavity in the back of the guitar shown in **Figure 14**.

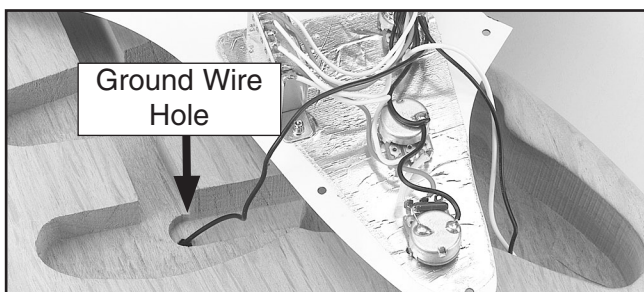

**Figure 14.** Ground wire hole.

—If there is not a predrilled hole in the cavity in **Step 1**, use a  $\frac{3}{32}$ " bit to drill a hole into the cavity and through the body.

- Push the thicker black audio jack wire through the hole shown in **Figure 15**.

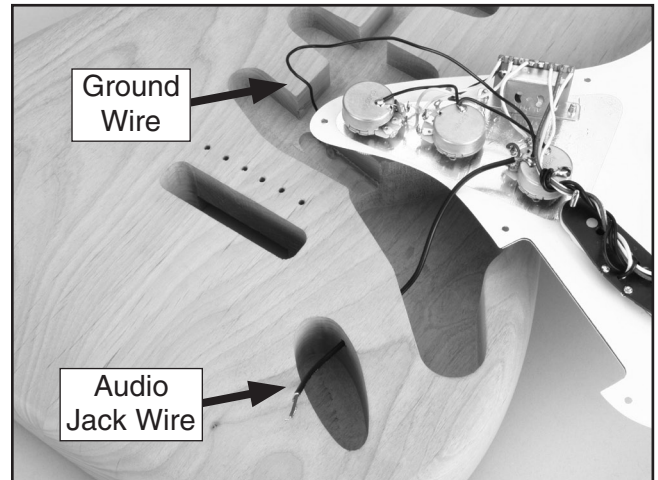

**Figure 15.** Audio jack wire.

- Place the pick guard on the guitar body as shown in **Figure 16**, and temporarily secure the pick guard to the body with masking tape. The pickups should fit into the routed channels.

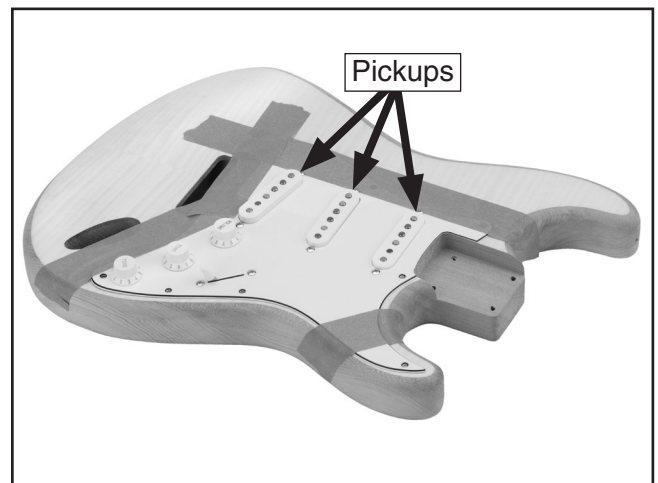

**Figure 16.** Pick guard placement.

- DO NOT drill the screws at this time! Final adjustments must be made after installing and winding the strings.

# Mounting Neck

Components and Hardware Needed:	Qty
Guitar Body .....	1
Neck .....	1
Silver Neckplate .....	1
Chrome Screws 5 x 45mm.....	4

Unless otherwise indicated, we strongly recommend using a drill press for the majority of drilling to obtain the most precise results. However, an electric/cordless drill fitted with a depth stop or a drill stand can be used if you do not have a drill press.

We recommend using a hollow punch (see **Page 24, Accessories**) to carve out holes in the finish before drilling. Also, a router pad placed under the guitar can help reduce scratches in the finish.

## To mount the neck to the guitar body:

1. Insert the neck into the neck pocket (in **Figure 17**), and check to make sure the neck and body are flush.

—If there is a gap between the neck and the body, lightly sand the high points on the neck until it fits in the pocket.

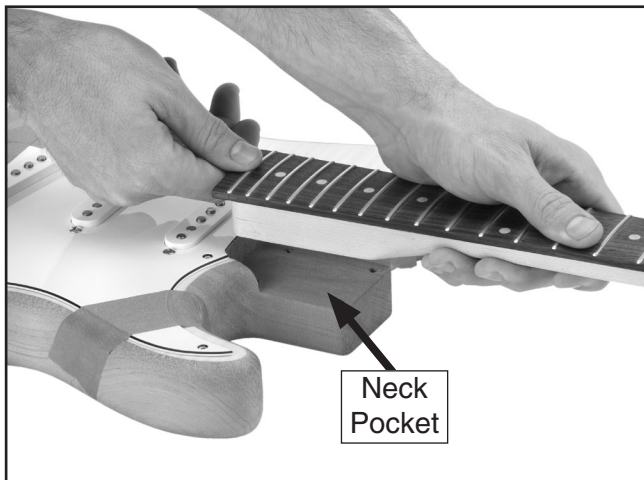

**Figure 17.** Inserting neck into neck pocket.

2. Clamp the neck and body together.
3. Set the guitar facedown on top of several 2x4's (cut to 6" or 12") for support.

4. By hand, insert a  $\frac{9}{64}$ " drill bit into each pre-drilled neck pocket hole (**Figure 18**). While pressing down slightly, twist the drill bit to make pilot holes in the neck.

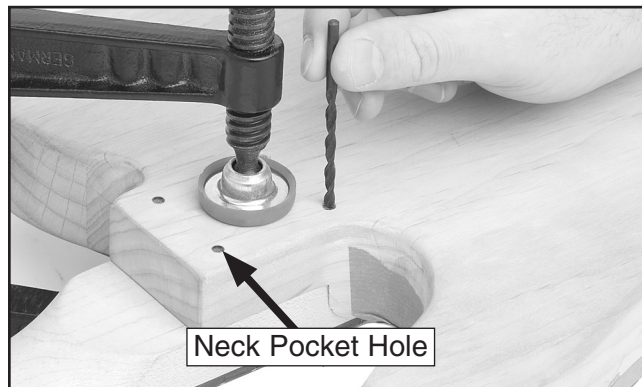

**Figure 18.** Making a pilot hole in the neck.

5. Unclamp the neck from the body.

## To determine neck mounting hole depth:

1. Secure a  $\frac{5}{32}$ " drill bit in the drill press chuck set the neck and fretboard down on top of a clean piece of scrap wood, set these on the drill press table, then raise the table.
2. Set the drill press depth stop so the tip of the bit will ONLY drive half way through the neck. DO NOT drill through the fretboard.

## Another way to determine neck mounting hole depth (optional):

1. Insert the neck into the neck pocket.
2. Place the neckplate on top of the body so a mounting hole protrudes beyond the body and neck (see **Figure 19**).

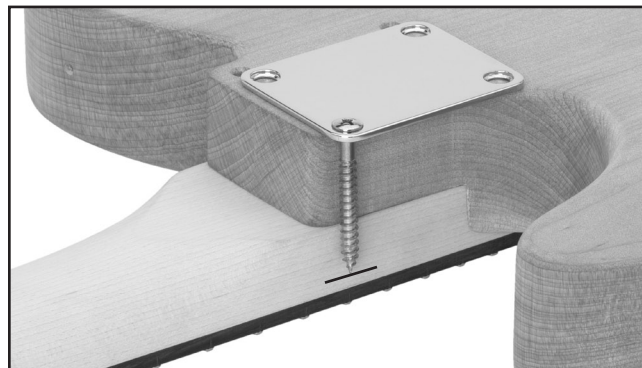

**Figure 19.** Using screw tip depth to set depth stop.



3. Insert a 5 x 45mm screw through the plate so it hangs down to the side of the neck and body.

4. Gently mark the screw tip depth with a pencil.

**Note:** You may want to cover the screw tip marking location with masking tape to avoid scratching the finish.

5. Set the neck fretboard face down on the drill press table, lower the bit to touch the mark (placed in **Step 4**), then set the drill press to stop at this mark.

#### To drill mounting holes in the neck:

Lower the  $\frac{5}{32}$ " drill bit over the center of the pilot holes and drill the holes to the correct depth.

#### To mount the neck to the body:

1. Insert the neck into the neck pocket, and place the neckplate on the body.

**Note:** DO NOT glue the neck to the body.

2. Align the mounting holes in the neck, body, and neckplate.

3. Fasten the four 5 x 45mm screws (**Figure 20**).



**Figure 20.** Fastening neck to body.

## Tremolo Bridge

Neck and Body (Assembled).....	1
Chrome Screws 3.5 x 30mm.....	6
Chrome Screws 4 x 40mm.....	2
Springs .....	4
Tremolo Arm.....	1

#### To attach the tremolo bridge to the guitar body:

1. Place the tremolo bridge in the cut-out shown in **Figure 21**.

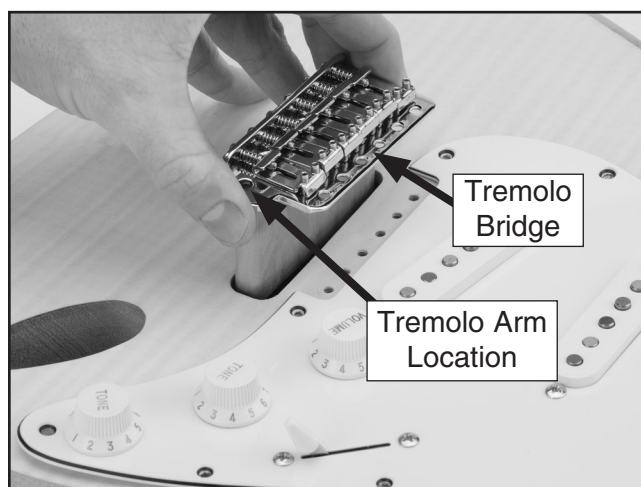

**Figure 21.** Tremolo bridge placement.

2. Secure the tremolo bridge to the guitar body with six 3.5 x 30mm screws.

3. Turn the guitar body over and place the spring hanger in the cavity as shown in **Figure 22**.

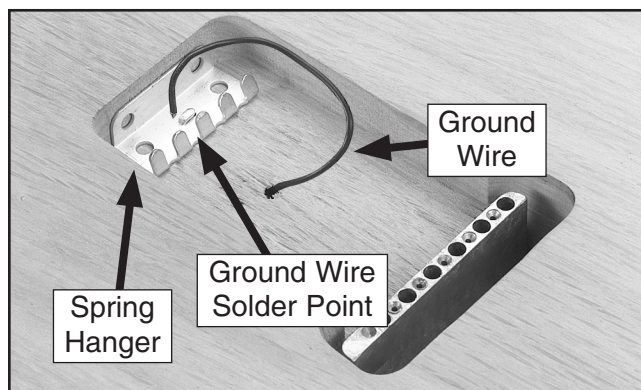

**Figure 22.** Spring hanger placement.



- Secure the spring hanger to the guitar body with two 4 x 40mm screws as shown in **Figure 23**. Tighten the screws until the spring hanger is 1" from the wall of the cavity.

**Note:** *These screws are used to adjust the spring tension.*

- Clean the spring hanger solder point to remove grease and dirt, then solder the black ground wire to the spring hanger as shown in **Figures 22 & 23**.
- Stretch the four springs from the spring hanger to the tremolo bridge as shown in **Figure 23**.

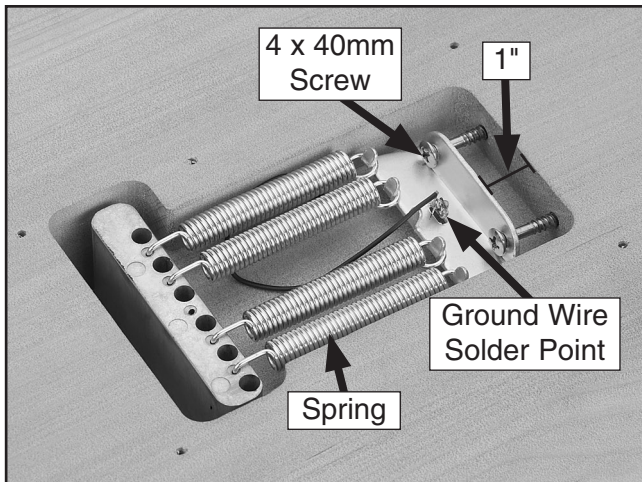

**Figure 23.** Correct spring placement.

—If the springs are too loose and will not grasp the spring hanger, tighten the screws to move the hanger closer to the body.

- Turn the guitar face up and screw the tremolo arm into the socket indicated by the arrow in **Figure 21**.

## Audio Jack

Components and Hardware Needed:	Qty
Neck and Body (Assembled).....	1
Audio Jack.....	1
Audio Jack Cover .....	1
Chrome Screws 3.1 x 12mm.....	2

### To attach the audio jack to the guitar body:

- Solder the wires to the tabs on the audio jack as shown in the **Wiring Diagram** on **Page 29** and the **Electrical Photos** on **Page 28**.
- Remove the nut and washer from the audio jack, insert the audio jack through the audio jack plate, and secure with the hex nut and washer, as shown in **Figure 24**.

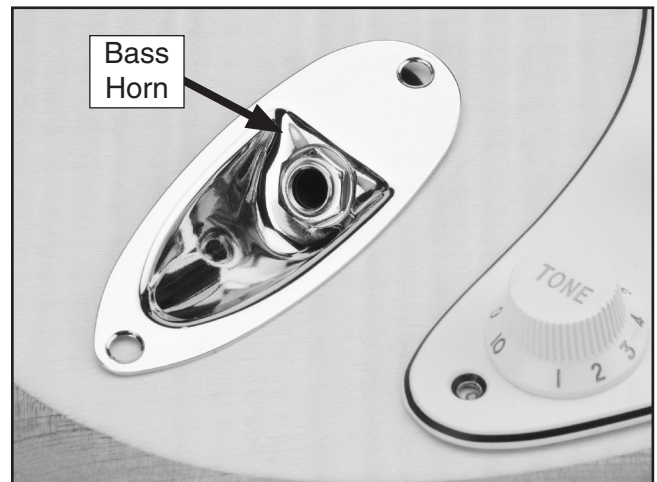
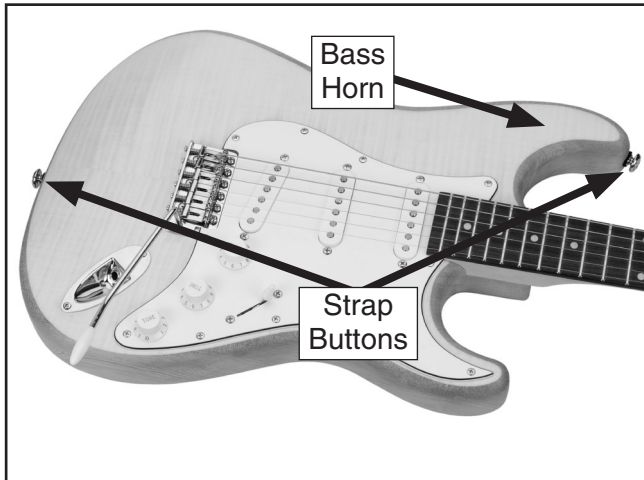

**Figure 24.** Audio jack inserted into audio jack plate.

- Insert the audio jack assembly into the cavity on the guitar body and secure it to the guitar body with masking tape.
- Using a  $\frac{3}{32}$ " drill bit, drill  $\frac{3}{8}$ " deep holes straight through the two holes in the audio jack.
- Secure the audio jack to the guitar body with two 3.1 x 12mm screws.

# Strap Buttons

The strap buttons are positioned on the guitar as shown in **Figure 25**.



**Figure 25.** Strap button placement.

Components and Hardware Needed	Qty
Guitar Body and Neck (Assembled).....	1
Chrome Screws 3.5 x 25mm .....	2
Strap Buttons.....	2

### To attach the strap buttons to the guitar:

1. Use a 3.5 x 25mm screw to secure each of the strap buttons to the guitar body, at the end of the guitar and on the bass horn (**Figure 25**).

—If the holes are not predrilled, use a  $\frac{3}{32}$ " drill bit to drill  $\frac{1}{2}$ " deep holes.

# Mounting Back Plate

Once mounted, the slot in the back plate must align with the string holes in the tremolo bridge. This will simplify the string installation and removal process.

Components and Hardware Needed:	Qty
Neck and Body (Assembled).....	1
Chrome Screws 3.1 x 12mm.....	6
Back Plate .....	1

### To mount the back plate to the guitar body:

1. Turn the guitar face down, position the back plate over the cavity in the back of the guitar body as shown in **Figure 26**, making sure the back plate hole is centered over the tremolo block holes.

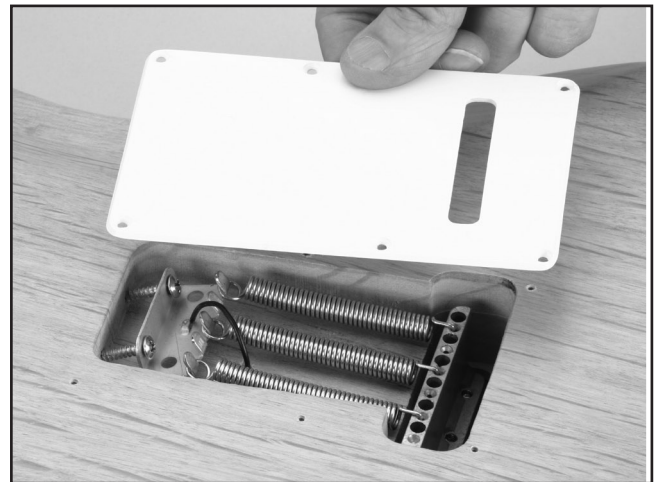

**Figure 26.** Mounting the back plate.

2. Secure the position of the back plate to the guitar body with masking tape.
3. Using a  $\frac{3}{32}$ " drill bit, drill  $\frac{5}{16}$ " deep holes straight through the six holes in the back plate.
4. Remove the protective plastic film from the back plate.
5. Secure the back plate to the guitar body with six 3.1 x 12mm screws, and remove the masking tape.



# Installing Nut

Components and Hardware Needed:	Qty
Neck and Body (Assembled).....	1
Nut .....	4

## To install the nut:

1. Turn the guitar face up and use a chisel or razor blade to scrape any finish out of the nut slot. **DO NOT** remove any wood from the nut slot.
2. Slide the nut into the slot.  
—If the nut will not fit into the slot, sand one side on a piece of sandpaper until it fits snugly into the slot as shown in **Figure 27**. Make sure the large grooves on the nut are toward the top of the neck.

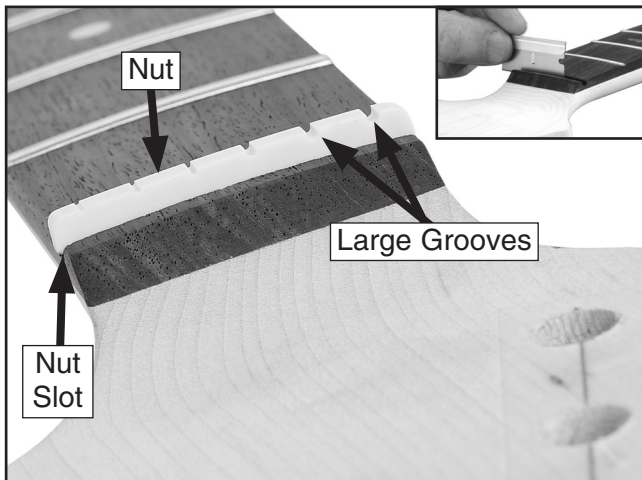

**Figure 27.** Nut installed. (Insert: craping nut slot)

3. Remove the nut, spread a thin layer of glue in the nut slot, and center the nut in the nut slot.
4. Clamp the nut in place.
5. Wipe away the excess glue before it sets up, then allow the glue to dry for 24 hours.

# Winding Strings

Components and Hardware Needed:	Qty
Neck and Body (Assembled).....	1
Strings .....	6

The correct position of the guitar strings is shown in **Figure 28**. The thin High "E" string is the "1st" string and the thick Low "E" string is the "6th."

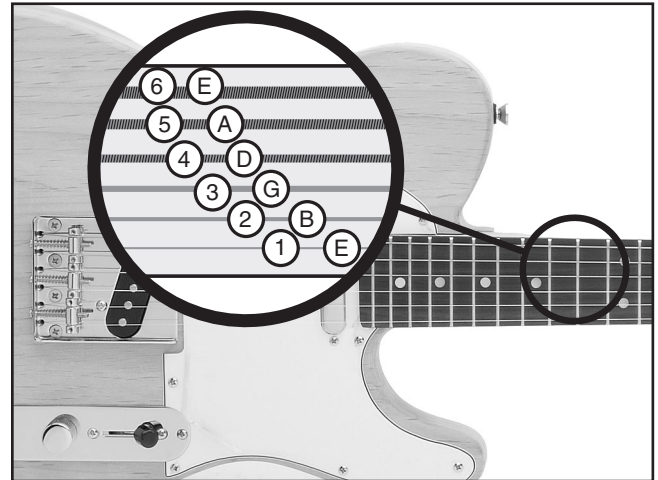

**Figure 28.** Example of correct string locations.

## To install the strings using the bridge:

1. Slide the 1st string through the corresponding hole in the tremolo block (**Figure 29**).

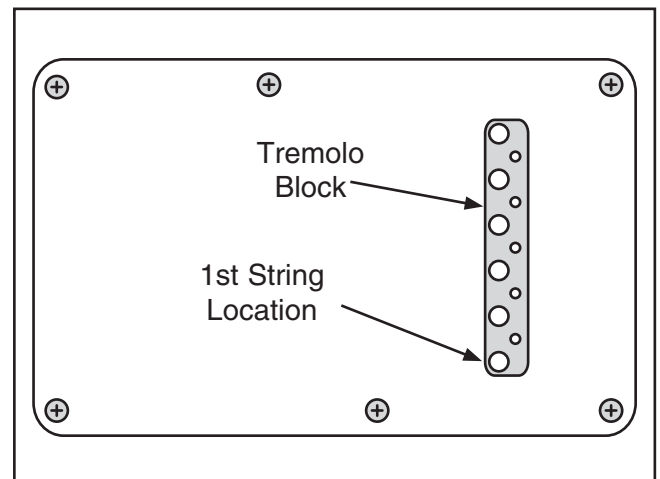

**Figure 29.** 1st string installed through tremolo block.

2. Guide the string through the tremolo bridge, across the saddle (**Figure 30**), over the nut, and through the hole in the corresponding tuning post.

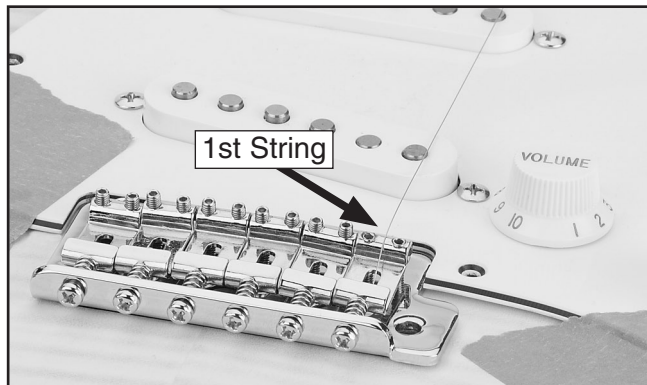

**Figure 30.** 1st string installed.

3. Allow only enough slack in the string for 2-3 rotations around the tuning post.

**Note:** *If too much slack is allowed, then the string could wind off the tuning post after many successive rotations. If not enough slack is allowed, then the string may not hold the winding tension.*

4. Bend the string at a right angle across the edge of the tuning post.
5. Rotate the tuner until the string just begins to hold the winding tension (**Figure 31**), and so the string is on the right side of the tuning post.

**Note:** *DO NOT tighten the strings beyond the initial tensioning at this time. Final tensioning should be completed during the string tuning process.*

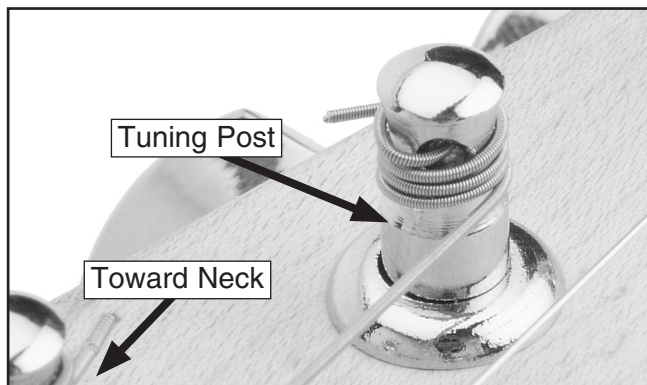

**Figure 31.** Example of string wrapped around tuning post.

6. Use wire cutters (optional) to cut off the excess string.
7. Repeat the above process for the remaining strings.

## Mounting Pick Guard

<b>Components and Hardware Needed:</b>		<b>Qty</b>
Neck and Body (Assembled).....		1
Chrome Screws 3.1 x 12mm.....		11

### To secure the pick guard to the guitar body:

1. Remove the protective plastic film from the pick guard.
2. Using a  $\frac{3}{32}$ " drill bit, drill  $\frac{5}{16}$ " deep holes straight through the eleven holes in the pick guard (**Figure 32**).



**Figure 32.** Pick guard mounting location.

3. Secure the pick guard to the guitar body with 3.1 x 12mm screws.
4. Remove the masking tape.

# String Retainers

The string retainers mount between the 1st and 2nd strings and between the 3rd and 4th strings (**Figure 33**). String retainers are designed to hold the strings down against the nut to enable correct tuning.

Components and Hardware Needed:	Qty
Neck and Body (Assembled).....	1
String Retainers.....	2
Bushings 4 x 5 x 3mm.....	2
Chrome Screws 2.5 x 14mm.....	2

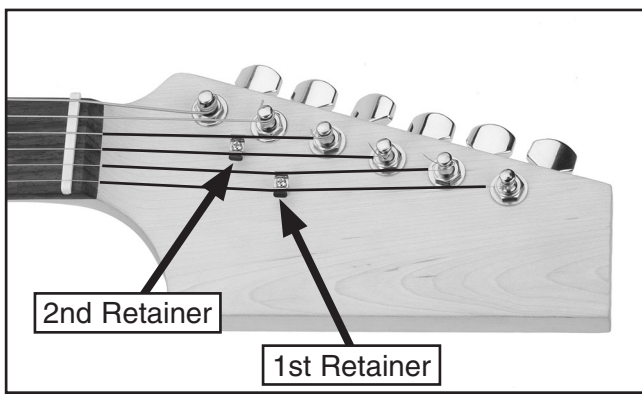

**Figure 33.** String retainer locations.

## To install the string retainer:

1. Place the 1st string retainer on top of the 1st and 2nd strings near the second tuner and loosen the strings several turns.
2. Using a  $\frac{1}{16}$ " drill bit positioned through the string retainer, drill a  $\frac{1}{4}$ " deep hole into the headstock.

**Note:** *Drilling the hole deeper than  $\frac{1}{2}$ " could result in drilling out the bottom of the headstock.*

3. Slide a 2.5 x 14mm screw through the retainer and bushing, then fasten it to the headstock (**Figure 33**).
4. Place the 2nd string retainer on top of the 3rd and 4th strings, loosen the strings, and repeat **Steps 2–3**.



# SECTION 5: SETUP

## General

Guitar set up is an art that requires skill, patience, and experience. If you have the patience, you can acquire the skill and experience. If you don't have the patience, you may want to have your guitar set up by a qualified guitar technician.

This section presents an overview of setup practices. We highly recommended that you research more in-depth methods. Books on setting up electric guitars can be ordered through Grizzly Industrial, luthier supply catalogs, or may be available through your local library.

## Neck Adjustment

The guitar neck was adjusted perfectly straight before it was packaged; however, the moisture content of wood acclimates to the humidity of the surrounding environment. This characteristic results in movement of the wood components affecting alignment. The neck may require adjustment several times each year, particularly in regions where the seasonal climate changes are more drastic.

Components and Hardware Needed:	Qty
Guitar with Strings Installed .....	1

### Tools Needed

Metal Straightedge 18" .....	1
Hex Wrench 4mm.....	1
Feeler Gauge Set .....	1
Phillips Head Screwdriver.....	1

### To adjust the bow of the guitar neck:

1. Tighten the strings to playing tension.

2. Place a straightedge from the 1st fret to the 17th. Measure any gaps between the straight-edge and the frets with the feeler gauge.

—If the neck is flat, or bowed up 0.012" or less, the neck is set up correctly. Continue to **String Height** instructions on **Page 21**.

—If the gap is greater than 0.012", or if the neck bows away from the straightedge, continue to **Step 3**.

3. Remove the strings from the neck, then remove the neck from the guitar body.
4. Turn the truss rod nut in the base of the neck (**Figure 34**) counterclockwise with a 4mm hex head wrench to release tension on the neck. Retighten until the nut begins to grab.



**Figure 34.** Typical truss rod nut.

5. To flatten a down bow, turn the truss rod nut a ¼ turn clockwise. To correct an up bow, turn the nut a ¼ turn counterclockwise.

6. Reinstall the neck, restring the guitar, and recheck the neck with the straightedge.

—If the neck is correctly adjusted, go to **String Height** instructions on **Page 21**.

—If the neck is still out of adjustment return to **Step 3**.



# String Height

Correct string height is crucial for maximizing the playability of your electric guitar. The string height is the distance between the top face of the fret and the bottom face of the string (**Figure 35**).

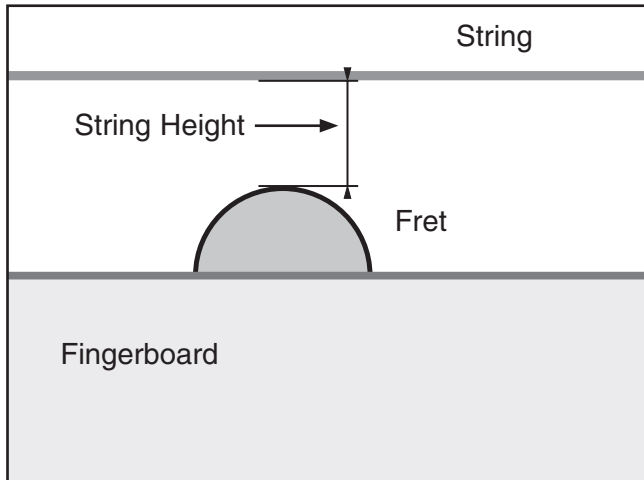

**Figure 35.** String height measurement.

## Tools Needed

	Qty
Hex Wrench 1.5mm .....	1
Guitar Capo .....	1
Metal Straightedge .....	1
Steel Ruler ( $\frac{1}{64}$ " Resolution).....	1
Wood Wedge .....	1

## To adjust the string height:

1. Remove the back plate and tremolo springs, and place a wood wedge between the tremolo block and tremolo cavity back (**Figure 36**).

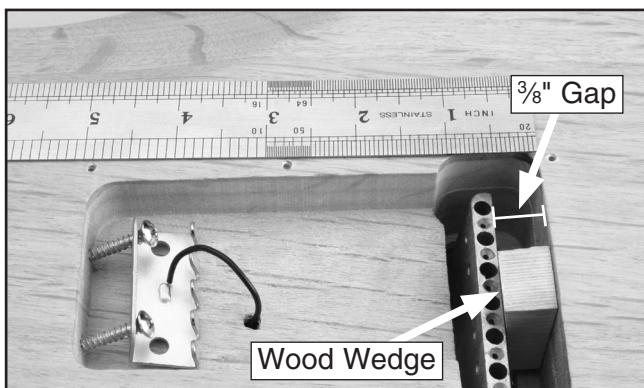

**Figure 36.** Tremolo wedge.

2. Adjust the wedge until there is a  $\frac{3}{8}$ " gap between the tremolo block and the back of the tremolo cavity as shown in **Figure 36**.
3. Tension the strings and then re-adjust the wedge if needed until there is a  $\frac{3}{32}$ " gap between the guitar body and the underside of the bridge plate as shown in **Figure 37**. Re-tension the strings if necessary.

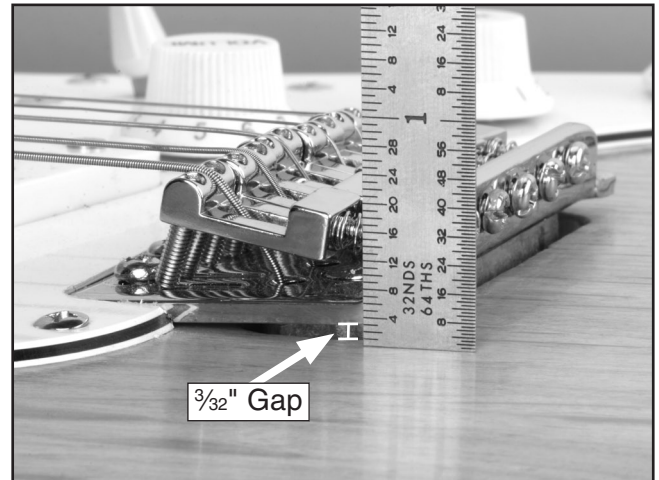

**Figure 37.** Tremolo wedge gap.

4. Place a capo on the 1st fret and measure the height of each string above the 17th fret as shown in **Figure 35**.

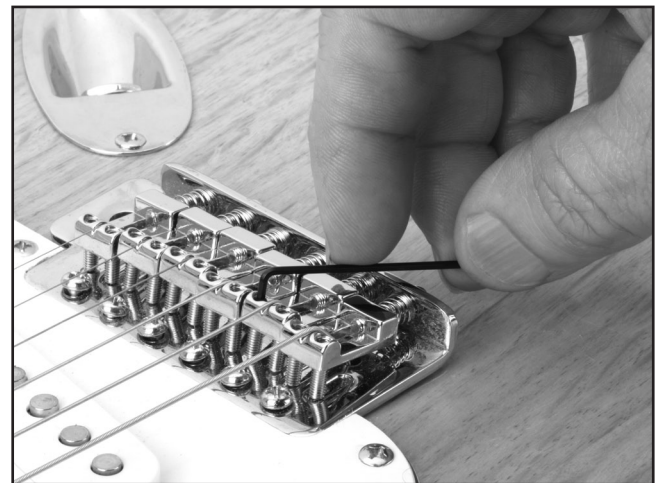

**Figure 38.** Adjusting string height.

5. Use the hex head wrench to adjust the height for each string until it is  $\frac{1}{16}$ " above the 17th fret.
6. Remove the capo.



# Pickup Height

Pickup height can have a dramatic effect on the audio output signal. The closer the strings are to the pickup, the higher the audio output signal will be. If the strings are too close, distortion is caused by magnetic interference from the electronic components.

Tools Needed	Qty
Metal Straightedge .....	1
Phillips Head Screwdriver.....	1

## To measure the string height at the pickup:

1. Measure the height of the 1st and 6th strings at the pickup while the strings are "fretted" at the 22nd fret (**Figure 39**).

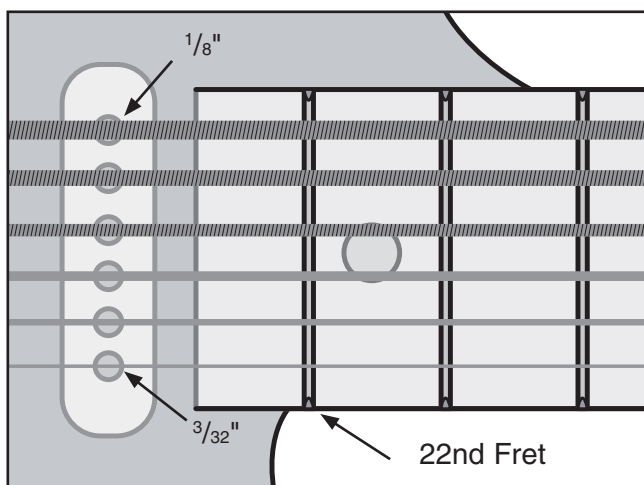
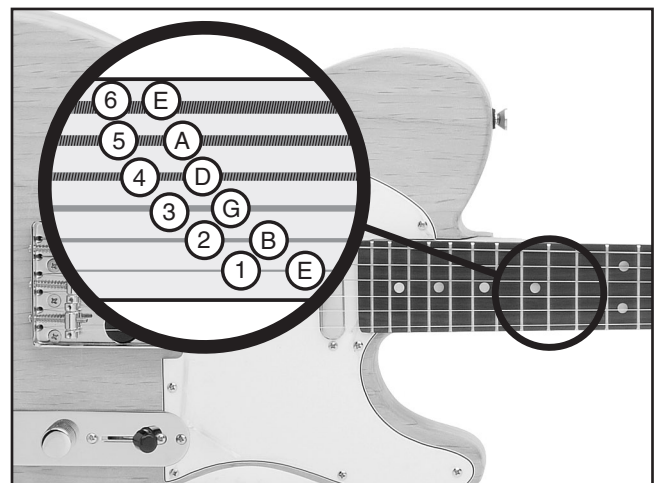

**Figure 39.** String heights over the pickup.

2. With a Phillips head screwdriver, adjust the screws on each side of the pickup until the 1st string is  $\frac{3}{32}$ " above the pickup and the 6th string is  $\frac{1}{8}$ " above the pickup.
  - Turn the screws clockwise to raise the height of the pickup.
  - Turn the screws counterclockwise to lower the height of the pickup.
3. Repeat **Steps 1–2** for the other pickups.

# Tuning

Tuning is an important guitar concept. If the guitar is not in tune, the resulting sound is unpleasant. These instructions explain how to tune by ear. You can also tune by using an electronic tuner such as the Grizzly H3097 Chromatic Tuner shown on **Page 24**.



**Figure 40.** Example of standard tuning.

## To tune the guitar:

1. Play a Low E pitch on a piano, a tuning fork, or an electronic computer file.
2. Play an open (non-fretted) 6th string and adjust the tuner to match the Low E.

**Note:** Always tune up. If the string is tuned high, loosen the string to lower the pitch, then tune the string up to the correct note.

3. Tune the 5th string by playing the 6th string while it is being pressed (fretted) at the 5th fret, and then play the open 5th string. Adjust the 5th string tuner until the notes match.





4. Tune the 4th string by playing the 5th string while it is being pressed (fretted) at the 5th fret, and then play the open 4th string. Adjust the 4th string tuner until the notes match.
5. Perform the same tuning step on the 3rd and 4th string.
6. When tuning the 2nd string, fret the 3rd string at the 4th fret instead of the 5th fret.
7. Tune the 1st string in the same manner as the 6th, 5th, 4th, and 3rd strings.

## Setting Intonation

Tools Needed	Qty
Phillips Head Screwdriver.....	1

Setting the intonation adjusts the length of the string to correct for flatness/sharpness on each string. This is a simple process that takes a lot of trial-and-error.

### To set the intonation:

1. Lightly touch and then release the 1st string directly above the twelfth fret as you pluck the string to play a harmonic note.
2. Now pluck the string while holding it fretted at the twelfth fret. If this note is sharper than the note played in **Step 1**, move the saddle away from the neck by turning the saddle adjustment screw (**Figure 41**) clockwise. If this note is flat in comparison, move the saddle toward the neck.

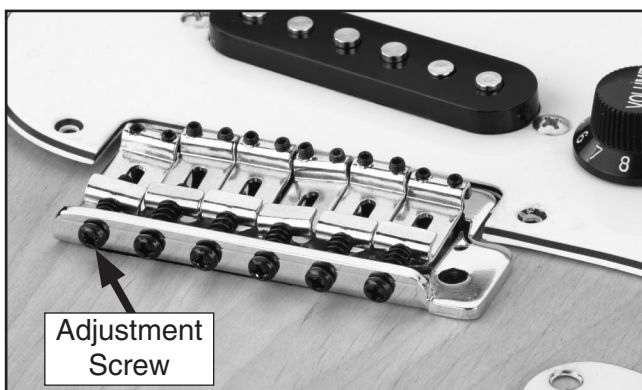

**Figure 41.** Example of saddle adjustment screw.

**Note:** This can also be done with an electronic tuner by tuning the harmonic note to be exactly in tune and then adjusting the saddle until the note played in **Step 2** is also in tune.

3. Repeat **Steps 1–2** until the string is in tune. Repeat the process for the rest of the strings.

## Tremolo Adjustment

### Tools Needed

Phillips Head Screwdriver.....	1
--------------------------------	---

### To adjust the tremolo springs:

1. Remove the tremolo cavity cover.
2. Install the four tremolo springs as shown in **Figure 42**.

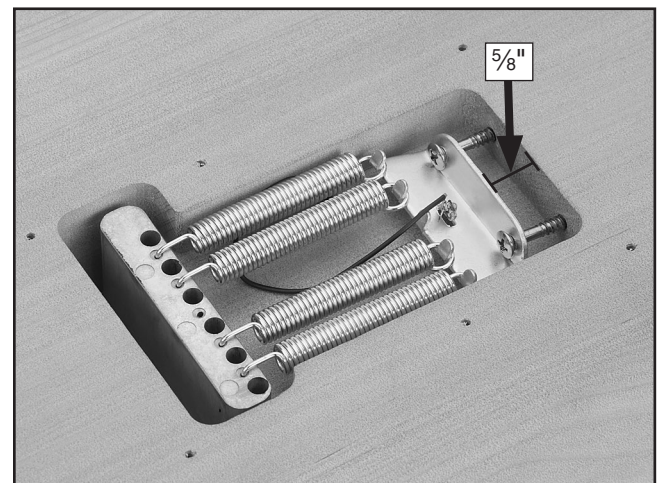

**Figure 42.** Correct spring placement.

3. Remove the wedge.
  - If the wedge is difficult to remove, tighten the spring hanger screws until the wedge loosens.

**Note:** The spring hanger should be approximately  $\frac{5}{8}$ " from the front edge of the tremolo cavity.

4. Replace the tremolo cavity cover.

# SECTION 6: REFERENCE INFO

## Accessories

**G7984—Face Shield**

**H1298—Dust Sealed Safety Glasses**

**H1300—UV Blocking, Clear Safety Glasses**

**H2347—Uvex® Spitfire Safety Glasses**

**H0736—Shop Fox® Safety Glasses**

Safety Glasses are essential to every shop. If you already have a pair, buy extras for visitors or employees. You can't be too careful when it comes to shop safety!



**Figure 43.** Our most popular safety glasses.

**H3097—Chromatic Tuner**

An absolute must for any guitar player, this tuner allows you to tune your acoustic or electric guitar dead on. Includes 9V battery.



**Figure 44.** Model H3097 Chromatic Tuner.

**H0818—Fine Prepolishing Paste, 1.85 lb**

**H4873—Medium Prepolish Liquid, 1 Qt**

**H0821—High Gloss Polishing Liquid, 1 Qt**

Menzerna professional polishing compounds will remove any fine scratches from the finish and give your instrument the incredibly high gloss finish that you are looking for.



**Figure 45.** Menzerna polishing compounds.

**G9845—6 Pc. Hollow Punch Set**

Punch perfectly round holes in one easy step. Includes knurl-gripped punches for  $\frac{3}{16}$ ",  $\frac{1}{4}$ ",  $\frac{5}{16}$ ",  $\frac{3}{8}$ ",  $\frac{7}{16}$ " and  $\frac{1}{2}$ " holes. Great for cutting gasket material!



**Figure 46.** Model G9845 Punch Set.

**Call 1-800-523-4777 To Order**

- H5750—Vinyl Washcoat/Sealer, 1Qt
- H5751—Nitrocellulose Lacquer, Gloss, 1 Qt
- H5752—Nitrocellulose Lacquer, Gloss, 1 Gal
- H5753—Nitrocellulose Lacquer, Satin, 1 Qt
- H5754—Nitrocellulose Lacquer, Satin, 1 Gal
- H5755—Retarder for Lacquer, 1 Qt
- H5756—Natural Filler, 1 Pint
- H5757—Mahogany Filler, 1 Pint
- H5759—Filler Reducer, 1Qt

McFadden's nitrocellulose lacquer is the leading lacquer used by custom guitar builders. It sprays and buffs really well and is capable of giving you a finish that looks "wet."



**Figure 47.** Model H5750-59 McFadden's Lacquers and Fillers.

**G1530—Router Pad**

This natural rubber pad eliminates holding or clamping work while routing or sanding. It effectively grips the workpiece for safe non-slip routing. Thin pad can be easily rolled up and stored when not in use. Pad measures 1/8" x 24" x 36"

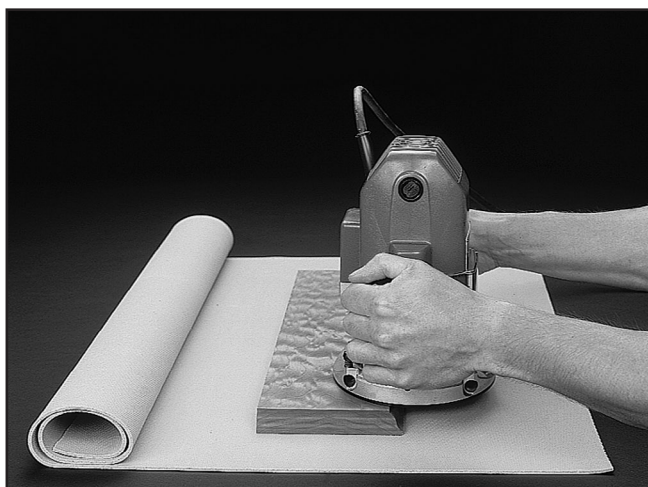

**Figure 48.** Model G1530 router pad.

- H2499—Small Half-Mask Respirator
- H3631—Medium Half-Mask Respirator
- H3632—Large Half-Mask Respirator
- H3633—Disposable Cartridge Filter Pair
- H3635—Disposable Cartridge Filter Pair

This lightweight elastomeric facepiece has cradle suspension, easy adjust headstraps and low profile for greater field of vision and compatibility with normal use of glasses or goggles. Purchase cartridges separately depending upon intended application.

Model H3633 protects against organic vapor, sulfur dioxide, hydrogen chloride and chlorine. Model H3635 protects against all particulate aerosols.



**Figure 49.** Half-mask respirator and disposable cartridge filters.

**Call 1-800-523-4777 To Order**



**Premier Red Mirror Finish Silicon Carbide Waterproof Sandpaper**

**Model H8912—1000 Grit, 50 Pack**

**Model H8913—1200 Grit, 50 Pack**

**Model H8914—1500 Grit, 50 Pack**

**Model H8915—2000 Grit, 50 Pack**

Ideal for producing very fine finishes in wet applications. Ultimate flexibility, and environmentally stable; resists humidity-caused curling. 50 sheets per package.



**Figure 50.** Model H8912 Sandpaper.

**H6074—Black 10' Guitar Cable**

**H6075—Black 15' Guitar Cable**

**H6076—Black 20' Guitar Cable**



**Figure 51.** Model H6074.

**Call 1-800-523-4777 To Order**

**Light Paper Backed A/O Sandpaper**

**Model G6194—80 Grit, 10 Pack**

**Model G6195—100 Grit, 10 Pack**

**Model G6196—120 Grit, 10 Pack**

**Model G6197—150 Grit, 10 Pack**

**Model G6198—180 Grit, 10 Pack**

**Model G6199—220 Grit, 10 Pack**

**Wet/Dry Silicon Carbide Sandpaper**

**Model G6200—100 Grit, 10 Pack**

**Model G6201—120 Grit, 10 Pack**

**Model G6202—180 Grit, 10 Pack**

**Model G6203—220 Grit, 10 Pack**

**Model G6204—240 Grit, 10 Pack**

**Model G6205—320 Grit, 10 Pack**

**Model G6206—400 Grit, 10 Pack**

We offer a variety of 9" x 11" sanding sheets in convenient 10 packs in 80 - 220 grits for just about any requirement.

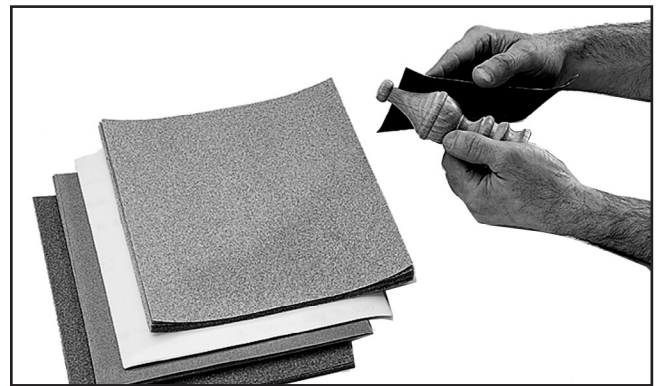

**Figure 52.** Assorted sandpaper.

**Model H5962—Guitar Stand-Electric/Archtop**



**Figure 53.** Model H5962 Guitar Stand.



### H4412—The Guitar Handbook

The Guitar Handbook is the complete guide to playing the guitar — from simple chords to advanced improvisations. Its unique learning program combines step-by-step photographs with a chord dictionary containing over 800 easy-to-follow fingerings. It is also a comprehensive manual on guitar hardware and performance technology, sound equipment and special effects. 256 pages.

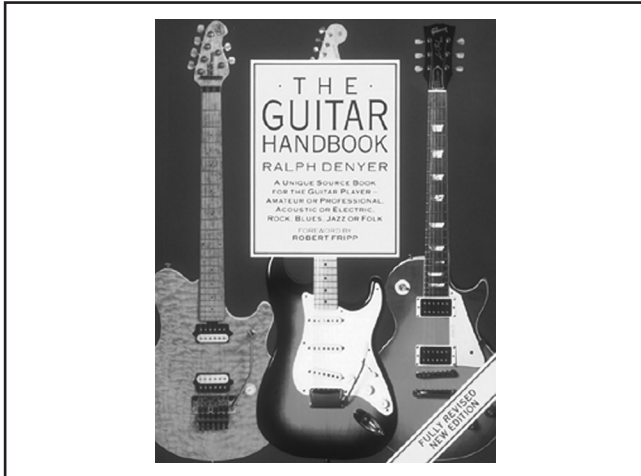

Figure 54. Model H4412.

### H4406—The Fender Stratocaster

This special 40th Anniversary Edition features the history, patents, schematics, pricing and identification tips for the Strat. Includes stunning color photos, original ads, famous Strat artists and much more. 72 pages.

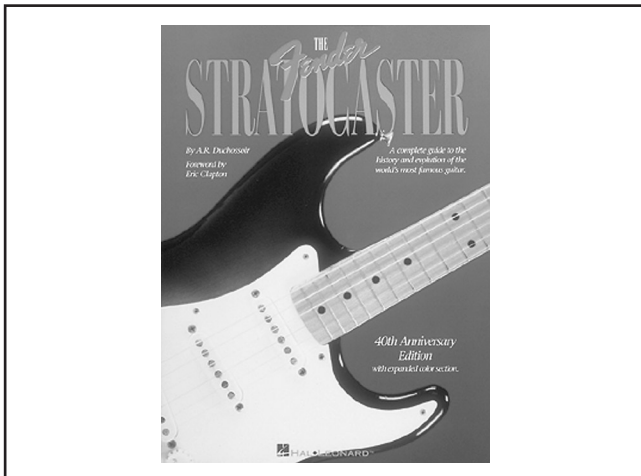

Figure 55. Model H4406.

### H6015—10 Watt Electric Guitar Amplifier



Figure 56. Model H6015 Guitar Amplifier.

### H6040—Samba® Electric Strings—Light

Light tension Electric Strings are nickel wound and include" 0.009" E-first and 0.011" B-second, 0.016" G-third, 0.024" D-fourth, 0.032" A-fifth, and 0.042" E-sixth.

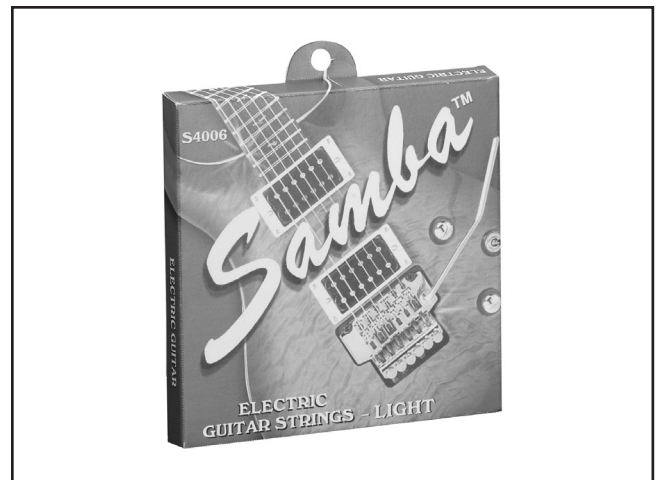

Figure 57. Model H6040.

### H6042—Samba® Electric Strings—Medium

Medium tension Deluxe Electric Strings are pure nickel and nickel wound and include .010"E-first and 0.013" B-second, 0.017" G-third, 0.026" D-fourth, 0.036" A-fifth, and 0.046" E-sixth.

**Call 1-800-523-4777 To Order**

# Electrical Components

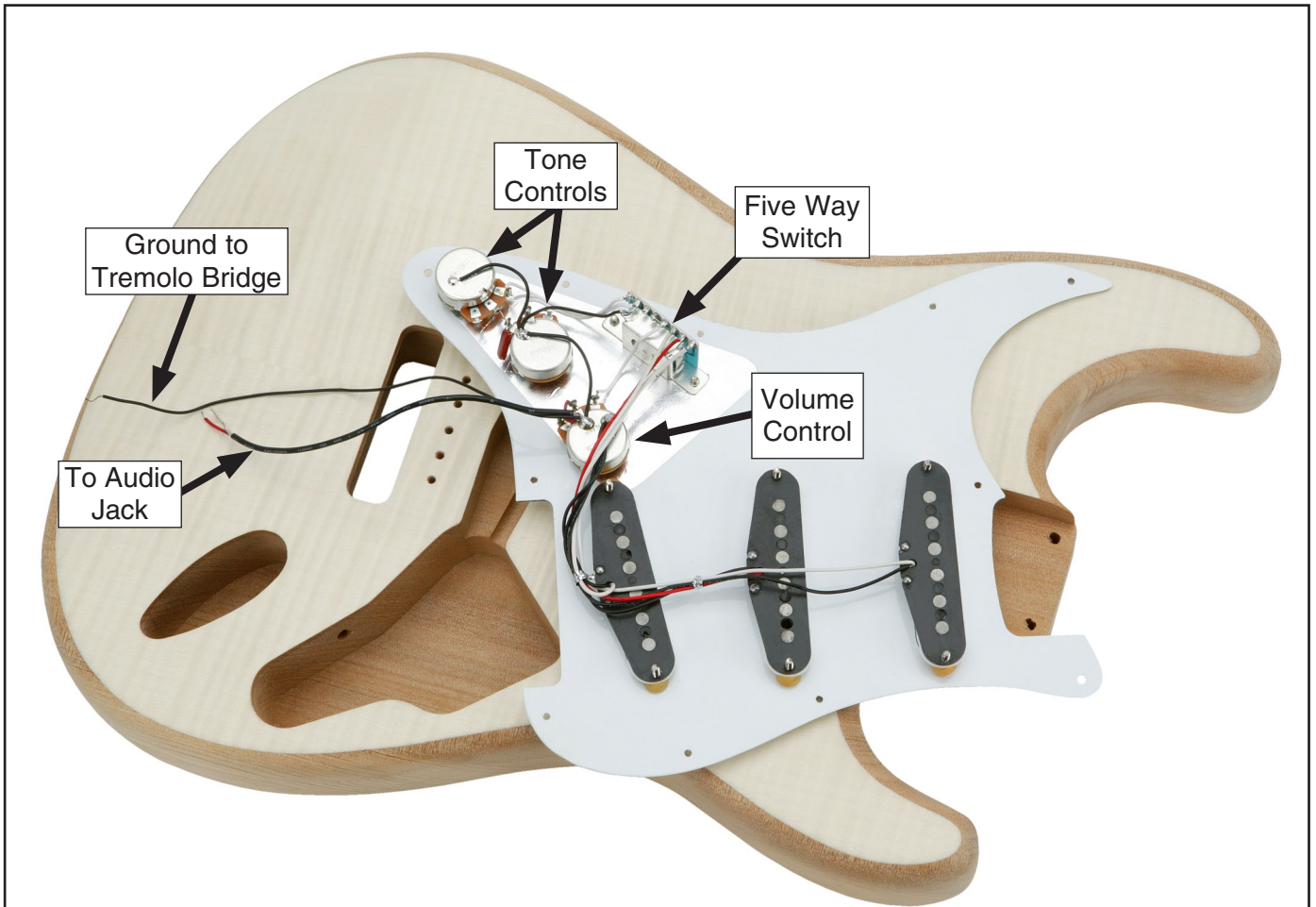

Figure 58. Pick guard wiring.

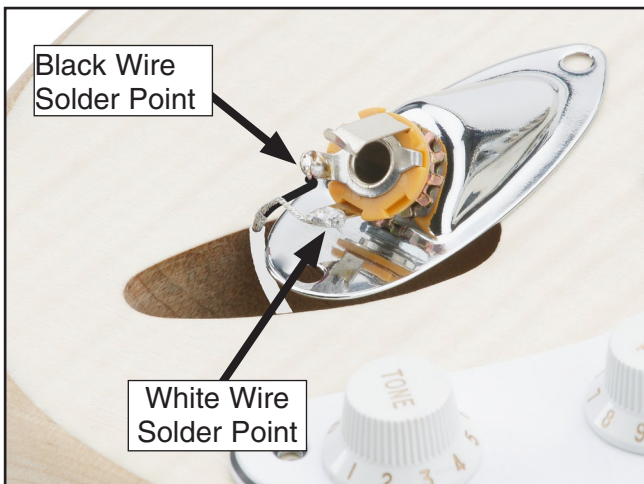

Figure 59. Audio jack wiring.

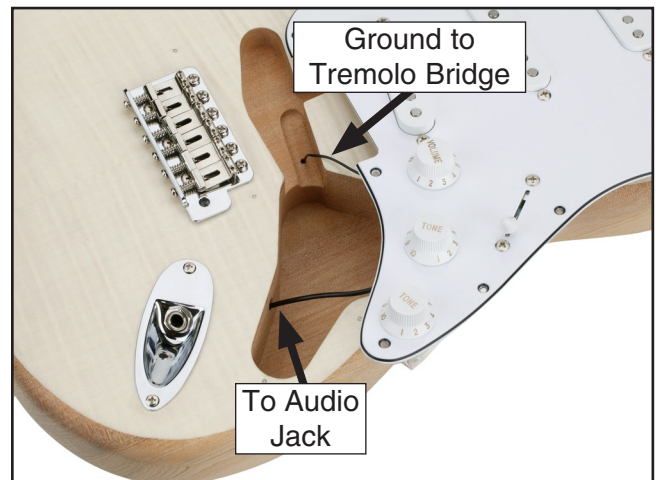

Figure 60. Ground wiring.

Available in color online at [www.grizzly.com](http://www.grizzly.com)

# Wiring Diagram



COLOR KEY	
BLACK	
WHITE	
RED	

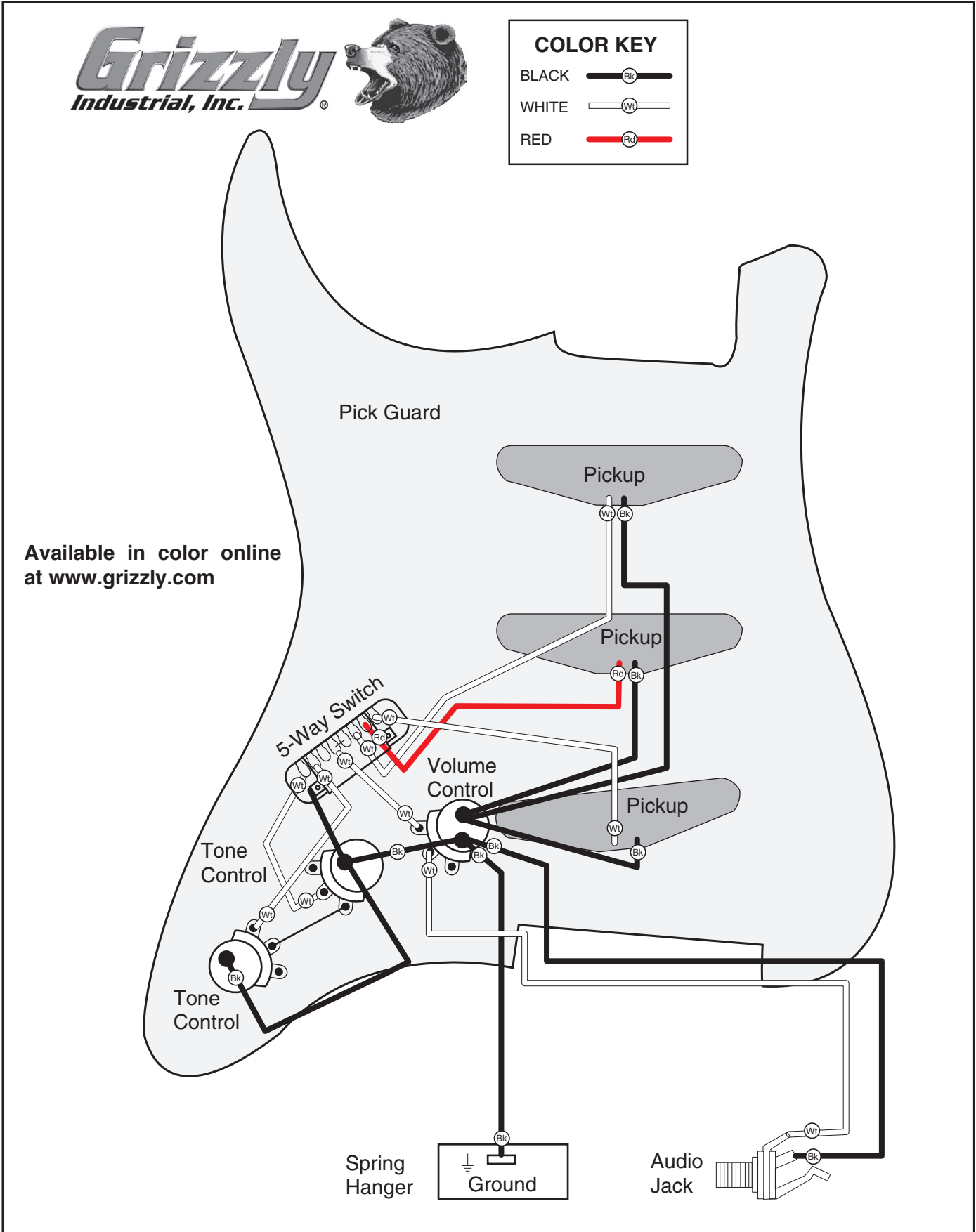

Available in color online at [www.grizzly.com](http://www.grizzly.com)

Figure 61. Model H8069 wiring diagram.



# WARRANTY AND RETURNS

---

Grizzly Industrial, Inc. warrants every product it sells for a period of **1 year** to the original purchaser from the date of purchase. This warranty does not apply to defects due directly or indirectly to misuse, abuse, negligence, accidents, repairs or alterations or lack of maintenance. This is Grizzly's sole written warranty and any and all warranties that may be implied by law, including any merchantability or fitness, for any particular purpose, are hereby limited to the duration of this written warranty. We do not warrant or represent that the merchandise complies with the provisions of any law or acts unless the manufacturer so warrants. In no event shall Grizzly's liability under this warranty exceed the purchase price paid for the product and any legal actions brought against Grizzly shall be tried in the State of Washington, County of Whatcom.

We shall in no event be liable for death, injuries to persons or property or for incidental, contingent, special, or consequential damages arising from the use of our products.

To take advantage of this warranty, contact us by mail or phone and give us all the details. We will then issue you a "Return Number," which must be clearly posted on the outside as well as the inside of the carton. We will not accept any item back without this number. Proof of purchase must accompany the merchandise.

The manufacturers reserve the right to change specifications at any time because they constantly strive to achieve better quality equipment. We make every effort to ensure that our products meet high quality and durability standards and we hope you never need to use this warranty.

Please feel free to write or call us if you have any questions about the machine or the manual.

Thank you again for your business and continued support. We hope to serve you again soon.







# WARRANTY CARD

Name \_\_\_\_\_  
 Street \_\_\_\_\_  
 City \_\_\_\_\_ State \_\_\_\_\_ Zip \_\_\_\_\_  
 Phone # \_\_\_\_\_ Email \_\_\_\_\_ Invoice # \_\_\_\_\_  
 Model # \_\_\_\_\_ Order # \_\_\_\_\_ Serial # \_\_\_\_\_

The following information is given on a voluntary basis. It will be used for marketing purposes to help us develop better products and services. **Of course, all information is strictly confidential.**

1. How did you learn about us?

Advertisement                       Friend                       Catalog  
 Card Deck                               Website                       Other:

2. Which of the following magazines do you subscribe to?

<input type="checkbox"/> Cabinet Maker	<input type="checkbox"/> Popular Mechanics	<input type="checkbox"/> Today's Homeowner
<input type="checkbox"/> Family Handyman	<input type="checkbox"/> Popular Science	<input type="checkbox"/> Wood
<input type="checkbox"/> Hand Loader	<input type="checkbox"/> Popular Woodworking	<input type="checkbox"/> Wooden Boat
<input type="checkbox"/> Handy	<input type="checkbox"/> Practical Homeowner	<input type="checkbox"/> Woodshop News
<input type="checkbox"/> Home Shop Machinist	<input type="checkbox"/> Precision Shooter	<input type="checkbox"/> Woodsmith
<input type="checkbox"/> Journal of Light Cont.	<input type="checkbox"/> Projects in Metal	<input type="checkbox"/> Woodwork
<input type="checkbox"/> Live Steam	<input type="checkbox"/> RC Modeler	<input type="checkbox"/> Woodworker West
<input type="checkbox"/> Model Airplane News	<input type="checkbox"/> Rifle	<input type="checkbox"/> Woodworker's Journal
<input type="checkbox"/> Modeltec	<input type="checkbox"/> Shop Notes	<input type="checkbox"/> Other:
<input type="checkbox"/> Old House Journal	<input type="checkbox"/> Shotgun News	

3. What is your annual household income?

\$20,000-\$29,000                       \$30,000-\$39,000                       \$40,000-\$49,000  
 \$50,000-\$59,000                       \$60,000-\$69,000                       \$70,000+

4. What is your age group?

20-29                                       30-39                                       40-49  
 50-59                                       60-69                                       70+

5. How long have you been a woodworker/metalworker?

0-2 Years                       2-8 Years                       8-20 Years                       20+ Years

6. How many of your machines or tools are Grizzly?

0-2                       3-5                       6-9                       10+

7. Do you think your machine represents a good value?

Yes                       No

8. Would you recommend Grizzly Industrial to a friend?

Yes                       No

9. Would you allow us to use your name as a reference for Grizzly customers in your area?

**Note:** We never use names more than 3 times.

Yes                       No

10. Comments: \_\_\_\_\_

\_\_\_\_\_  
 \_\_\_\_\_

CUT ALONG DOTTED LINE

FOLD ALONG DOTTED LINE

---

---

---



Place  
Stamp  
Here



GRIZZLY INDUSTRIAL, INC.  
P.O. BOX 2069  
BELLINGHAM, WA 98227-2069



FOLD ALONG DOTTED LINE

Send a Grizzly Catalog to a friend:

Name	_____
Street	_____
City	_____
State	_____
Zip	_____

TAPE ALONG EDGES--PLEASE DO NOT STAPLE



# *grizzly.com*

**TOOL WEBSITE**

Buy Direct and Save with Grizzly® – Trusted, Proven and a Great Value!

*Visit Our Website Today And Discover  
Why Grizzly® Is The Industry Leader!*

- SECURE ORDERING
- ORDERS SHIPPED WITHIN 24 HOURS
- E-MAIL RESPONSE WITHIN ONE HOUR

-OR-

Call Today For A **FREE**  
Full Color Catalog

**1-800-523-4777**



## Free Manuals Download Website

<http://myh66.com>

<http://usermanuals.us>

<http://www.somanuals.com>

<http://www.4manuals.cc>

<http://www.manual-lib.com>

<http://www.404manual.com>

<http://www.luxmanual.com>

<http://aubethermostatmanual.com>

Golf course search by state

<http://golfingnear.com>

Email search by domain

<http://emailbydomain.com>

Auto manuals search

<http://auto.somanuals.com>

TV manuals search

<http://tv.somanuals.com>