

# *Grizzly* *Industrial, Inc.*®

## MODELS T10493, T10494, T10495 4", 5" & 6" ANGLE GRINDERS

### OWNER'S MANUAL (For models manufactured since 10/11)



COPYRIGHT © OCTOBER, 2011 BY GRIZZLY INDUSTRIAL, INC.  
WARNING: NO PORTION OF THIS MANUAL MAY BE REPRODUCED IN ANY SHAPE  
OR FORM WITHOUT THE WRITTEN APPROVAL OF GRIZZLY INDUSTRIAL, INC.  
#KN14446 PRINTED IN CHINA



## **WARNING!**

This manual provides critical safety instructions on the proper setup, operation, maintenance, and service of this machine/tool. Save this document, refer to it often, and use it to instruct other operators.

Failure to read, understand and follow the instructions in this manual may result in fire or serious personal injury—including amputation, electrocution, or death.

The owner of this machine/tool is solely responsible for its safe use. This responsibility includes but is not limited to proper installation in a safe environment, personnel training and usage authorization, proper inspection and maintenance, manual availability and comprehension, application of safety devices, cutting/sanding/grinding tool integrity, and the usage of personal protective equipment.

The manufacturer will not be held liable for injury or property damage from negligence, improper training, machine modifications or misuse.



## **WARNING!**

Some dust created by power sanding, sawing, grinding, drilling, and other construction activities contains chemicals known to the State of California to cause cancer, birth defects or other reproductive harm. Some examples of these chemicals are:

- Lead from lead-based paints.
- Crystalline silica from bricks, cement and other masonry products.
- Arsenic and chromium from chemically-treated lumber.

Your risk from these exposures varies, depending on how often you do this type of work. To reduce your exposure to these chemicals: Work in a well ventilated area, and work with approved safety equipment, such as those dust masks that are specially designed to filter out microscopic particles.

# SECTION 1: SAFETY

## **WARNING**

### **For Your Own Safety Read Instruction Manual Before Operating This Equipment**

The purpose of safety symbols is to attract your attention to possible hazardous conditions. This manual uses a series of symbols and signal words which are intended to convey the level of importance of the safety messages. The progression of symbols is described below. Remember that safety messages by themselves do not eliminate danger and are not a substitute for proper accident prevention measures.

 **DANGER** Indicates an imminent hazardous situation which, if not avoided, **WILL** result in death or serious injury.

 **WARNING** Indicates a potentially hazardous situation which, if not avoided, **COULD** result in death or serious injury.

 **CAUTION** Indicates a potentially hazardous situation which, if not avoided, **MAY** result in minor or moderate injury. It may also be used to alert against unsafe practices.

**NOTICE** This symbol is used to alert the user to useful information about proper operation of the equipment.

## **WARNING**

### **Safety Instructions For Power Tools**

**KEEP ALL SAFETY DEVICES IN PLACE** and in working order.

**REMOVE ADJUSTING KEYS AND WRENCHES.** Form habit of checking to see that keys and adjusting wrenches are removed from tool before operation.

**KEEP WORK AREA CLEAN.** Cluttered areas and benches invite accidents.

**DO NOT USE IN DANGEROUS ENVIRONMENT.** Do not use electric tools in damp or wet locations, or where any flammable or noxious fumes may exist. Keep work area well lighted.

**KEEP CHILDREN AND VISITORS AWAY.** All children and visitors should be kept at a safe distance from work area.

**MAKE WORKSHOP CHILD PROOF** by locking your shop and shutting off the power.

**DO NOT FORCE TOOL.** It will do the job better and safer at the rate for which it was designed.

**USE THE RIGHT TOOL.** Do not force tool or attachment to do a job for which it was not designed.

**DO NOT USE UNDER THE INFLUENCE OF DRUGS OR ALCOHOL.**

# **WARNING**

## **Safety Instructions for Power Tools (continued)**

### **ALWAYS USE SAFETY GLASSES.**

Also use a face or dust mask if cutting operation is dusty. Everyday eyeglasses only have impact resistant lenses, they are NOT safety glasses.

### **WEAR APPROVED HEARING**

**PROTECTION.** Always wear hearing protection when operating or observing loud power tools. Extended exposure to this noise without hearing protection can cause permanent hearing loss.

### **SECURE WORK.**

Use clamps or a vise to hold work when practical. It is safer than using your hand and frees both hands to operate tool.

### **MAINTAIN TOOLS WITH CARE.**

Keep tools lubricated and clean for best and safest performance. Follow instructions for lubricating and changing accessories.

### **WEAR PROPER APPAREL.**

Do not wear loose clothing, gloves, neckties, rings, bracelets, or other jewelry that may get caught in moving parts. Non-slip footwear is recommended. Wear a protective hair covering to contain long hair.

### **REDUCE THE RISK OF**

**UNINTENTIONAL USE.** Do not carry tool with hand on trigger and always disconnect from power when not in use.

## **WARNING**

Like all power tools there is potential danger when operating this tool. Accidents are frequently caused by lack of familiarity or failure to pay attention. Use this tool with respect and caution to lessen the possibility of operator injury. If normal safety precautions are overlooked or ignored, serious personal injury may occur.

## **CAUTION**

No list of safety guidelines can be complete. Every shop environment is different. Always consider safety first, as it applies to your individual working conditions. Use this and other power tools with caution and respect. Failure to do so could result in serious personal injury, damage to equipment or poor work results.

# **WARNING**

## **Additional Safety Instructions for Angle Grinders**

**EYE PROTECTION.** Grinding causes small particles to become airborne at a high rate of speed. ALWAYS wear safety glasses when using this tool.

**CRACKED WHEEL.** Cracked wheels may break and fly apart during operation. Inspect wheels for damage before each use and replace cracked wheels immediately!

**HAND/WHEEL CONTACT.** Grinding wheels have the capability of removing a lot of skin fast. Keep a firm grip on the tool and ensure the guard and handle are installed appropriately. Wear close fitting work gloves whenever possible to avoid injury from grinding debris.

**WHEEL SPEED RATING.** Wheels operated at a faster speed than what they are rated for may break or fly apart. Before mounting a new wheel, be sure the wheel RPM rating is equal to or higher than the speed of the tool.

**LUNG PROTECTION.** Abrasive grinding produces hazardous dust, which may cause long-term respiratory problems if breathed. Always wear a NIOSH approved dust mask or respirator when grinding.

**TOOL STABILITY.** Hold the tool with both hands and stabilize your hands and body against a fixed object. Grinding using one hand and no support can allow the tool to grab the workpiece and cause you to lose your grip, leading to serious personal injury.

**WHEEL FLANGES.** Only use the flanges included with the tool when mounting wheels. Other flanges may not properly secure the wheel and cause an accident.

**FIRE/EXPLOSION HAZARD.** Grinders are capable of creating sparks, which can ignite flammable materials. Make sure no flammables are in the path of sparks or the surrounding area.

**IMPACT INJURIES.** A grinder is capable of propelling objects at a high rate of speed. Keep work area free of clutter and make sure workpieces are secure before use. Remove adjusting wrenches before connecting to power.

**ENTANGLEMENT HAZARD.** Tools with rotating components can become entangled in hair, clothing, jewelry or other dangling objects, resulting in serious personal injury. Tie back hair or loose clothing and remove any jewelry.

**RISK OF ELECTRIC SHOCK.** Grinding into workpieces with hidden wiring can result in shock or electrocution. Check for hidden wiring before any grinding.

**CHANGING WHEELS.** Wheels should be replaced whenever they reach a size where contact between the mounting flanges and workpiece may occur, or the usable area of the wheel is  $\frac{1}{2}$  its original size.

# SECTION 2: INTRODUCTION

---

---

## Foreword

---

---

We are proud to offer this manual with your new tool! We've made every effort to be exact with the instructions, specifications, drawings, and photographs of the tool we used when writing this manual. However, sometimes we still make an occasional mistake.

Also, owing to our policy of continuous improvement, your tool may not exactly match the manual. If you find this to be the case, and the difference between the manual and the tool leaves you in doubt, check our website for the latest manual update or call technical support for help.

For your convenience, we post all available manuals and manual updates for free on our website at [www.grizzly.com](http://www.grizzly.com). Any updates to your model of tool will be reflected in these documents as soon as they are complete.

## Contact Info

---

---

We stand behind our tools. If you have any service questions, parts requests or general questions about the tool, please call or write us at the location listed below.

Grizzly Industrial, Inc.  
1203 Lycoming Mall Circle  
Muncy, PA 17756  
Phone: (570) 546-9663  
E-Mail: [techsupport@grizzly.com](mailto:techsupport@grizzly.com)

We want your feedback on this manual. If you can take the time, please email or write to us at the address below and tell us how we did:

Grizzly Industrial, Inc.  
C/O Technical Documentation Manager  
P.O. Box 2069  
Bellingham, WA 98227-2069  
Email: [manuals@grizzly.com](mailto:manuals@grizzly.com)

# Specifications

MODEL SPECIFICATIONS	T10493	T10494	T10495
Motor	120V	120V	120V
Amps	5.2	7.5	7.5
RPM	10,500	8,800	8,800
Wheel Size	4", 5/8" Bore	5", 7/8" Bore	6", 7/8" Bore
Spindle Size	3/8"-16	5/8"-11	5/8"-11
Weight	4.3 lbs.	6.4 lbs.	6.4 lbs.
Plug	NEMA 1-15P, Polarized	NEMA 1-15P, Polarized	NEMA 1-15P, Polarized

# Identification

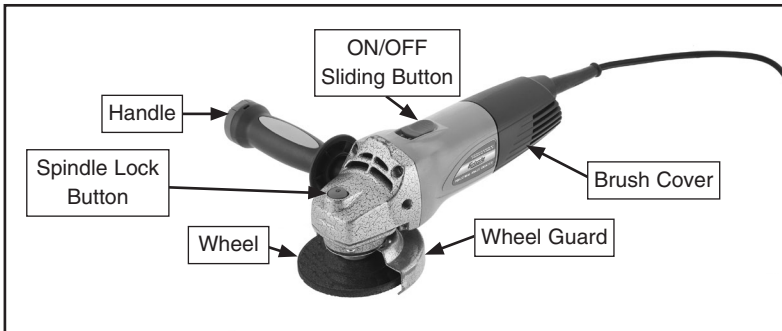

**Figure 1.** T10493 grinder and component identification.

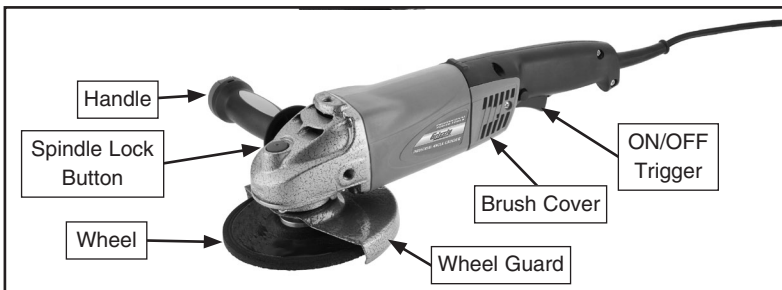

**Figure 2.** T10494 & T10495 grinder and component identification.

# SECTION 3: SETUP

## Unpacking

This tool was carefully packaged for safe transportation. Remove the packaging materials from around the tool and inspect it. If you discover any damage, *please immediately call Customer Service at (570) 546-9663 for advice.*

Save the containers and all packing materials for possible inspection by the carrier or its agent. Otherwise, filing a freight claim can be difficult.

When you are completely satisfied with the condition of your shipment, inventory the contents.

If any non-proprietary parts are missing (e.g., a nut or a washer), we will gladly replace them; or for the sake of expediency, replacements can be obtained at your local hardware store.

### **WARNING**

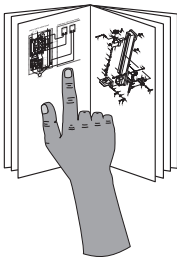

**This tool presents serious injury hazards to untrained users. Read through this entire manual to become familiar with the controls and operations before using the tool!**

## Inventory

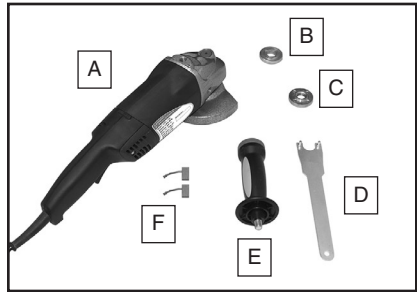

Figure 3. Inventory contents.

Description	Qty
A. Grinder (T10495 shown).....	1
B. Inner Flange.....	1
C. Outer Flange.....	1
D. Fixed Pin Spanner Wrench.....	1
E. Handle.....	1
F. Replacement Carbon Brushes.....	1
D. Grinding Wheel 30 Grit (not shown) ..	1

### **WARNING**

**Serious injury could occur if you connect this tool to power before completing the setup process. DO NOT connect to power until instructed later in this manual.**



## Assembly

### Adjusting the Wheel Guard

The wheel guards can be adjusted for maximum safety during grinding operations.

#### To adjust the guard:

1. Remove the wheel and both flanges.
2. Loosen the three Phillips head screws in the guard plate.
3. Rotate wheel guard to the desired position and retighten the screws loosened in **Step 2**.

**Note:** The mounting hardware for Model T10493 and Models T10494 and T10495 are different. For Model T10493, ensure that the guard plate clip is seated in one of the five position holes on the wheel guard, as shown in **Figure 4**.

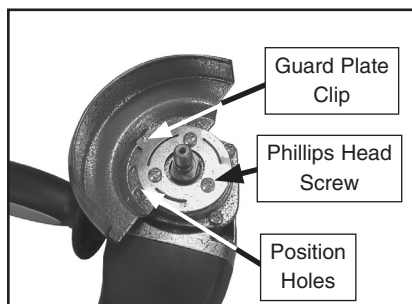

**Figure 4.** Adjusting the T10493 wheel guard.

4. Re-install the wheel and flanges (refer to **Installing/Changing Grinding Wheels on Page 16**).

## **!** CAUTION

Always consider the position of the wheel guard when installing the handle. **NEVER** operate the grinder with the handle installed toward the open face of the guard. This could lead to injury.

### Installing the Handle

These Angle Grinders include a handle and mounting holes for different handle configurations, as shown in **Figures 5–6**. The handle provides added stability while operating the grinder. Choose the configuration that provides the most safe and stable grinder control for each task, and thread the handle into the appropriate hole.



**Figure 5.** Three handle configurations for T10494/T10495.



**Figure 6.** Two handle configurations for the T10493.

# Power Connection

---

---

## Polarized Plug Requirements

This grinder is equipped with a 16AWG power cord and typical 1-15 polarized plug. This plug may only be inserted into a typical grounded receptacle (outlet) one way. DO NOT attempt to force it into the receptacle. Ensure that the plug is fully inserted before operating this tool.

### **WARNING**

**Serious injury could occur if you connect the tool to power before completing the setup process. DO NOT connect to power until instructed later in this manual.**

After you have completed all the previous setup instructions, the tool is ready to be connected to the power supply.

To avoid unexpected startups or property damage, use the following steps whenever connecting or disconnecting the tool.

## Connecting Power

1. Turn the tool power switch OFF.
2. Insert the power cord plug into a matching power supply receptacle. The tool is now connected to the power source (see **Figure 7**).

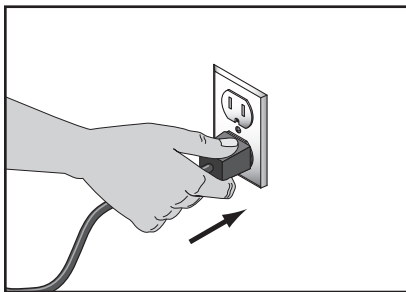

**Figure 7.** Connecting to power.

## Disconnecting Power

1. Turn the tool power switch OFF.
2. Grasp the molded plug and pull it completely out of the receptacle. Do not pull by the cord as this may damage the wires inside (see **Figure 8**).

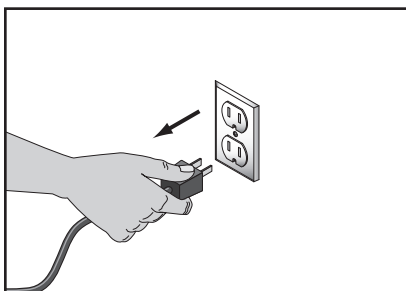

**Figure 8.** Disconnecting power.

# Test Run

---

---

Once assembly is complete and a grinding wheel is installed (see **Installing/Changing Grinding Wheel** on **Page 16** for detailed instructions), test run the grinder to make sure it runs properly and is ready for regular operation.

**The test run consists of verifying the following:**

- The motor powers up and runs correctly.
- The safety mechanism works correctly.

**Note:** *The Model T10493 has a locking slide switch. Models T10494 and T10495 have a trigger safety button that must be depressed before the trigger operates.*

If, during the test run, you cannot easily locate the source of an unusual noise or vibration, stop using the tool immediately, then review **Troubleshooting** on **Page 14**. If you still cannot remedy a problem, contact our Tech Support at (570) 546-9663 for assistance.

**To test run the grinder:**

1. DISCONNECT TOOL FROM POWER!
  2. Rotate the wheel by hand and make sure it turns freely and is tightly secure on the spindle.
  3. Confirm that the guard and handle are in a safe configuration and securely in place.
4. Make sure you have read and understand the safety instructions at the beginning of the manual and that the grinder is setup properly.
  5. Connect the grinder to power, as shown on **Page 8**. For Model T10493 proceed to **Step 6**; for Models T10494 and T10495 skip to **Step 7**.
  6. While firmly holding the grinder, turn the grinder **ON**. The switch should lock in the ON position.
    - If operating correctly, the grinder will remain running. Depressing the switch will make it spring back and turn the tool **OFF**. The grinder is ready to use.
    - If the locking slide switch does not automatically return to the OFF position when pressed, it is *not* functioning properly. Turn the tool **OFF** and contact Tech Support.
  7. Press the safety button then pull the trigger.
    - If operating correctly, the tool will turn on and remain running as long as you hold down the trigger. Proceed to **Step 8**.
    - If the tool does *not* turn ON the trigger is *not* working properly. Disconnect power and contact Tech Support.
  8. Try to depress the trigger without pressing the trigger safety button.
    - If operating correctly, the tool should *not* turn on. The grinder is ready to use.
    - If the grinder does turn ON the trigger safety is *not* working properly. Turn the tool **OFF** and contact Tech Support.

# SECTION 4: OPERATIONS

## **⚠ WARNING**

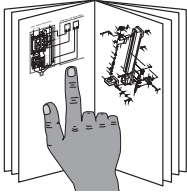

This tool presents serious injury hazards to untrained users. Read through this entire manual to become familiar with the controls and operations before using the tool!

## **⚠ WARNING**



**EYE INJURY HAZARD!**  
Wear safety goggles with full eye protection from all sides when using this grinder.

## **⚠ WARNING**



**LUNG/EAR INJURY HAZARD!**  
Wear protective equipment when using this tool.

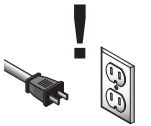

**ACCIDENTAL START HAZARD!**  
Disconnect power before service or wheel changes.

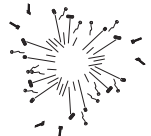

**Wheel SHATTER HAZARD!**  
Never exceed RPM rating for wheels.

## Using the Angle Grinder

Read and understand all safety instructions in this manual before starting.

Always test on a scrap piece of material similar to the workpiece. Trial and error is often the best way to determine the ideal setup.

### To use the angle grinder:

1. If the workpiece is not completely stable on its own, make sure it is securely held in a vise or a similar device that will ensure it does not move during operation.
2. Make sure the grinding wheel is properly secured on the spindle by tightening the outer flange.

## **⚠ WARNING**

Never use this tool without the guard installed. **DO NOT** modify the guard in any way. Using this tool with a removed or modified guard greatly increases the risk of personal injury.

3. Attach the grinder to the correct power supply.
4. Hold the grinder securely in both hands, and turn it **ON**.
5. Ease the wheel against the workpiece with a light but steady pressure.
6. Turn the grinder **OFF**.

# SECTION 5: ACCESSORIES

- H0736—Shop Fox® Safety Glasses
- H7194—Bifocal Safety Glasses 1.5
- H7195—Bifocal Safety Glasses 2.0
- H7196—Bifocal Safety Glasses 2.5
- T20502—Face Shield Crown Protector
- T20503—Face Shield Window
- T20451—"Kirova" Clear Safety Glasses
- T20452—"Kirova" Anti-Reflective Safety Glasses

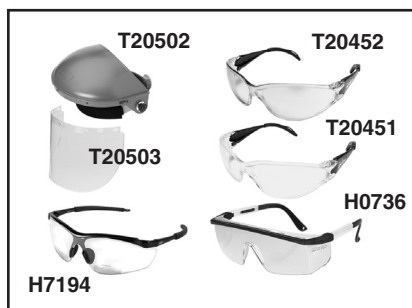

Figure 9. Eye protection assortment.

- H4978—Deluxe Earmuffs - 27dB
  - H4979—Twin Cup Hearing Prot. - 29dB
  - T20446—Ear Plugs 200 Pair - 31dB
- Protect your hearing before it's too late. Especially important if you or employees operate for hours at a time.



Figure 10. Hearing protection assortment.

- T20928—Nuisance Dust Mask
- T21767—Smart Mask
- G7870—Half Mask Respirator: Oil / Organic Vapor
- G7871—Particulate Filter
- G7872—Filter Retainer
- G7866—Particulate Respirator
- G7867—Particulate Respirator w/Valve

These maintenance-free Half Mask Respirators come completely and permanently assembled with cartridges so they're ready to use. Each features a soft, lightweight elastomeric face piece, cradle suspension, easy-adjust head straps and low profile for greater field of vision with use of eyeglasses or goggles. The particulate respirators have custom-designed shapes, nosepieces and head straps for superior fit and have collapse resistant, double-shell construction. The T21767 smart mask is individually packaged and features a large 3D-cup shape for better fit and 40% less breathing resistance.



Figure 11. Personal air filtration.

## Call 1-800-523-4777 To Order

## ZIRCONIA FLAP DISCS

These high density Zirconia Flap Discs are made of overlapping cloth backed sandpaper segments that are designed to wear away, constantly exposing fresh grains. Zirconia grit provides up to 3 times faster material removal than resin fiber discs and premium abrasive cloth provides up to 15 times longer life than resin fiber discs.

### FOR MODEL T10493

**H4994—4"  $\frac{5}{8}$ " Bore Type 27 40 Grit**

**H4248—4"  $\frac{5}{8}$ " Bore Type 27 60 Grit**

**H4249—4"  $\frac{5}{8}$ " Bore Type 27 80 Grit**

### FOR MODEL T10494

**H4997—5"  $\frac{7}{8}$ " Bore Type 27 40 Grit**

**H4258—5"  $\frac{7}{8}$ " Bore Type 27 60 Grit**

**H4259—5"  $\frac{7}{8}$ " Bore Type 27 80 Grit**



**Figure 12.** Type 27 Zirconia flap discs.

## TYPE 27 GRINDING WHEELS

These grinding wheels will make quick work of grinding jobs. The  $\frac{1}{8}$ " wheels work great for notching and light cut-off operations, while the  $\frac{1}{4}$ " wheels can handle your toughest work.

### FOR MODEL T10493

**G7381—4" x  $\frac{1}{8}$ ",  $\frac{5}{8}$ " Bore Grind Wheel**

**G7382—4" x  $\frac{1}{4}$ ",  $\frac{5}{8}$ " Bore Grind Wheel**

### FOR MODEL T10494

**T24311—5" x  $\frac{1}{4}$ "  $\frac{7}{8}$ " Bore Grind Wheel**

### FOR MODEL T10495

**T24310—6" x  $\frac{1}{4}$ ",  $\frac{7}{8}$ " Bore Grind Wheel**



**Figure 13.** Type 27 depressed center grinding wheels.

**Call 1-800-523-4777 To Order**

# SECTION 6: MAINTENANCE

## **WARNING**



**EYE INJURY HAZARD!**  
Wear safety goggles with full eye protection from all sides when using or servicing this grinder.

## **WARNING**



**LUNG/EAR INJURY HAZARD!**  
Wear protective equipment when using this tool.

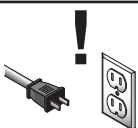

**ACCIDENTAL START HAZARD!**  
Disconnect power before service or wheel changes.

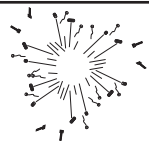

**Wheel SHATTER HAZARD!**  
Never exceed RPM rating for wheels.

## Regular Maintenance

These procedures should be done before and after each use:

- Check the wheel before each use to ensure no cracks and chips are present, and that wheel size is sufficient to safely grind.

*Note: To avoid property damage, the size of the wheel should be large enough to prevent the outer flange from coming into contact with the workpiece in a typical grinding operation.*

- Outer flange is tight and wheel is secure.
- Handle and guard are in proper position and firmly attached to the grinder.
- For Models T10494 and T10495, ensure that the trigger safety button is in proper working condition.
- For Model T10493, ensure that ON/OFF locking slide switch is in proper working condition.

# SECTION 7: SERVICE

## Troubleshooting

**IMPORTANT: Tool repairs must be completed by a qualified service person.**

Symptom	Possible Cause	Solution
Motor does not run.	<ol style="list-style-type: none"><li>1. The tool is not getting power.</li><li>2. Carbon brushes are worn out and need to be replaced.</li></ol>	<ol style="list-style-type: none"><li>1. Check power connection.</li><li>2. Replace both carbon brushes (see <b>Page 15</b>).</li></ol>
Grinder becomes hot or burning smell comes from motor during operation.	<ol style="list-style-type: none"><li>1. The motor has overheated.</li><li>2. Debris has entered the motor housing and is burning during motor operation.</li></ol>	<ol style="list-style-type: none"><li>1. Allow the grinder to run idle for about two minutes to cool off.</li><li>2. Open brush covers and clean out motor housing using a vacuum.</li></ol>
Grinder vibrates excessively during use.	<ol style="list-style-type: none"><li>1. The grinding disc is not properly installed.</li><li>2. Screws or parts of the grinder are loose.</li><li>3. Workpiece is not securely fastened.</li><li>4. Grinding wheel is unbalanced or damaged.</li></ol>	<ol style="list-style-type: none"><li>1. Check the inner and outer flange to ensure they are properly seated (see <b>Page 16</b>).</li><li>2. Check the grinder and ensure that the screws and covers are tight.</li><li>3. Clamp the workpiece firmly to a heavy and stable surface.</li><li>4. Replace the grinding wheel (see <b>Page 16</b>).</li></ol>





# Changing Motor Brushes

These grinders use carbon brushes that wear out over time and need replacing.

Tools Needed	Qty
Phillips Head Screwdriver #2 .....	1
Flat Head Screwdriver #2.....	1

## To inspect/change the carbon brushes:

1. Remove the brush covers, as shown in **Figures 15–16**.

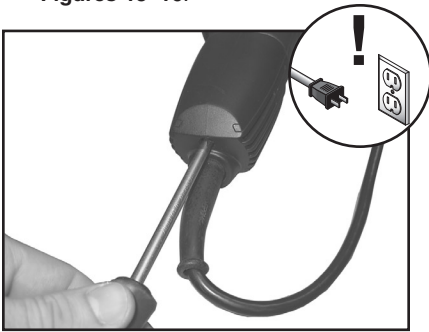

**Figure 15.** T10493 brush cover.



**Figure 16.** Removing the T10494 and T10495 brush covers.

**Note:** Models T10494 and T10495 have a brush cover on each side of the grinder.

2. With the #2 flat head screwdriver, release the tension on the flat coil spring that holds the carbon brush in place, as shown in **Figure 17**.

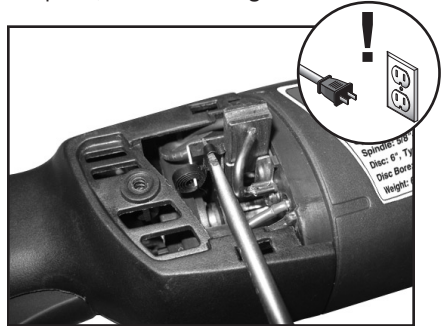

**Figure 17.** Release spring tension.

3. Remove the carbon brushes from the brush holder assemblies.
4. Inspect the brushes.
  - If the brushes are longer than  $\frac{1}{4}$ " , they are still an acceptable length and can still be used—unless the motor is having troubles. Proceed to **Step 6**.
  - If the brushes are shorter than  $\frac{1}{4}$ " , install new carbon brushes in the brush holder assemblies, then proceed to **Step 5**.
5. Replace the brush cover(s) and test run the grinder (see **Page 9**).

# Installing/Changing Grinding Wheels

These Angle Grinders use Type 27 grinding wheels. Refer to **Specifications** on **Page 5** to match the grinder to the proper wheel. See **Accessories** on **Page 11** for wheel options.

## **⚠**WARNING

Always install a grinding wheel that is the correct size and RPM rating for your grinder. Failure to do so may cause injury from the grinding wheel failing and throwing pieces toward the operator at high speed.

### Tools Needed

Qty

Fixed Pin Spanner Wrench ..... 1  
New Grinding Wheel ..... 1

### To install or change the wheel:

1. Press the spindle lock button and rotate the wheel until the button engages and the spindle ceases to turn.
2. While holding the spindle lock button, position the fixed pin spanner wrench in the outer flange and turn counterclockwise to loosen the flange, as shown in **Figure 18**.

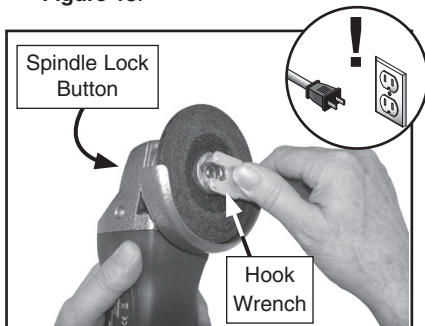

**Figure 18.** Changing grinder wheel.

3. Remove the outer flange and old wheel.
4. Install the new wheel.
5. Replace the outer flange and tighten it while depressing the spindle lock button.

**Note:** The inner flange can unseat once the wheel is removed. Be sure the alignment keys of the inner flange seat properly to the grinder spindle and that the raised hub of the outer flange seats inside the bore of the grinding wheel, as shown in **Figure 19**.

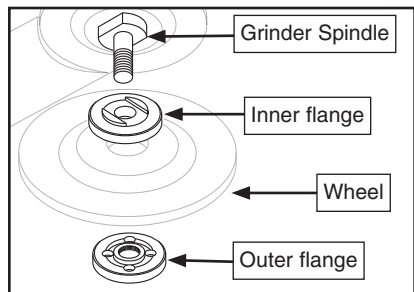

**Figure 19.** Inner and outer flange installation alignment.

# SECTION 8: PARTS

## T10494 & T10495 Main Breakdown

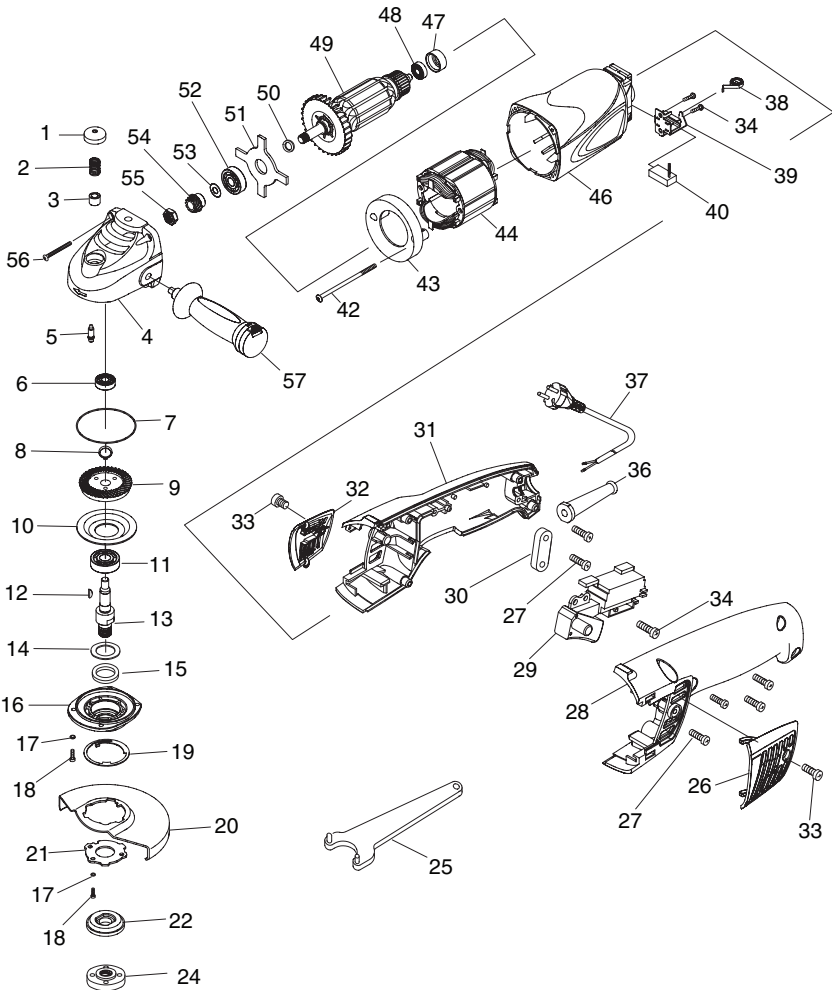

**Parts breakdown provided for reference only.  
Not all parts shown are available for purchase.**

# T10494 & T10495 Main Parts List

REF	PART #	DESCRIPTION
1	PT10494001	BRAKING PIN BUTTON
2	PT10494002	COMPRESSION SPRING
3	PT10446003	NEEDLE BEARING HK0810
4	PT10494004	GEAR HOUSING
5	PT10494005	BRAGING PIN
6	P608ZZ	BALL BEARING 608ZZ
7	PT10494007	O-RING
8	PR01M	EXT RETAINING RING 10MM
9	PT10494009	TAPER GEAR
10	PT10494010	BEARING PLATE
11	P6201ZZ	BALL BEARING 6201ZZ
12	PT10493009	WOODRUFF KEY 3 X 10
13	PT10494013	OUTPUT SPINDLE 5/8"-11
14	PT10494014	OUTPUT SPINDLE WASHER
15	PT10494015	OIL SEAL FELT RING
16	PT10494016	BEARING HOLDER
17	PW05M	FLAT WASHER 4MM
18	PS110M	PHLP HD SCR M4-.7 X 4
19	PT10494019	ELASTIC WASHER
20	PT10494020	WHEEL GUARD 5" (T10494)
20	T10495020	WHEEL GUARD 6" (T10495)
21	PT10494021	GUARD PLATE
22	PT10494022	INNER FLANGE
24	PT10494024	OUTER FLANGE
25	PT10494025	FIXED PIN SPANNER WRENCH
26	PT10494026	LEFT BRUSH COVER
27	PHTEK6M	TAP SCREW M4 X 16

REF	PART #	DESCRIPTION
28	PT10494028	LEFT HANDLE
29	PT10494029	ON/OFF SWITCH FA4-02B
30	PT10494030	CABLE CLAMP
31	PT10494031	RIGHT HANDLE
32	PT10494032	RIGHT BRUSH COVER
33	PHTEK5M	TAP SCREW M4 X 12
34	PHTEK1M	TAP SCREW M3.5 X 12
36	PT10494036	CABLE ARMOR
37	PT10494037	POWER CORD 16G 2W 72" 1-15
38	PT10494038	FLAT COIL SPRING
39	PT10494039	BRUSH HOLDER ASSEMBLY
40	PT10494040	CARBON BRUSH
42	PHTEK53M	TAP SCREW M4 X 70
43	PT10494043	FAN GUIDE
44	PT10494044	STATOR
46	PT10494046	HOUSING
47	PT10494047	RUBBER BEARING SLEEVE
48	P607ZZ-C4	BALL BEARING 607ZZ-C4
49	PT10494049	ARMATURE
50	PT10494050	ARMATURE WASHER
51	PT10494051	BAFFLE PLATE
52	P6200ZZ-C4	BALL BEARING 6200ZZ-C4
53	PT10494053	OIL SEALING PLATE
54	PT10494054	TAPER PINION
55	PT10494055	PINION NUT
56	PHTEK28M	TAP SCREW M4 X 25
57	PT10493044	HANDLE

## T10494 & T10495 Labels Breakdown

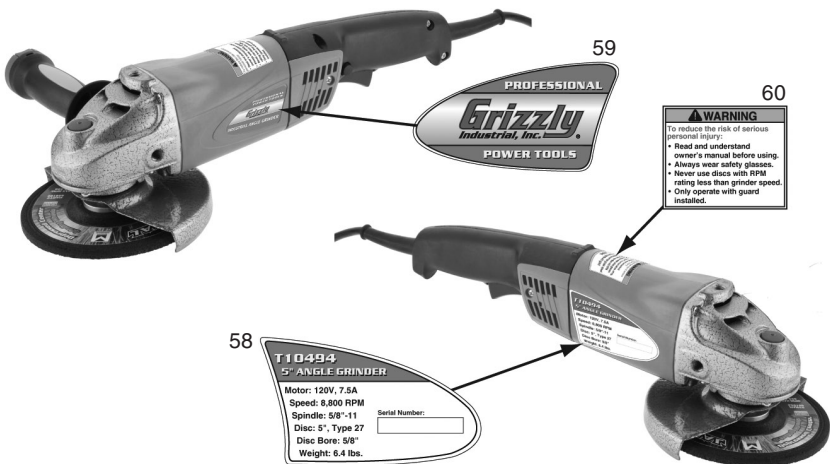

REF	PART #	DESCRIPTION
58	PT10494058	MACHINE ID LABEL (T10494)
58	PT10495058	MACHINE ID LABEL (T10495)

REF	PART #	DESCRIPTION
59	PT10494059	GRIZZLY LABEL
60	PT10493053	SAFETY LABEL

# T10493 Main Breakdown

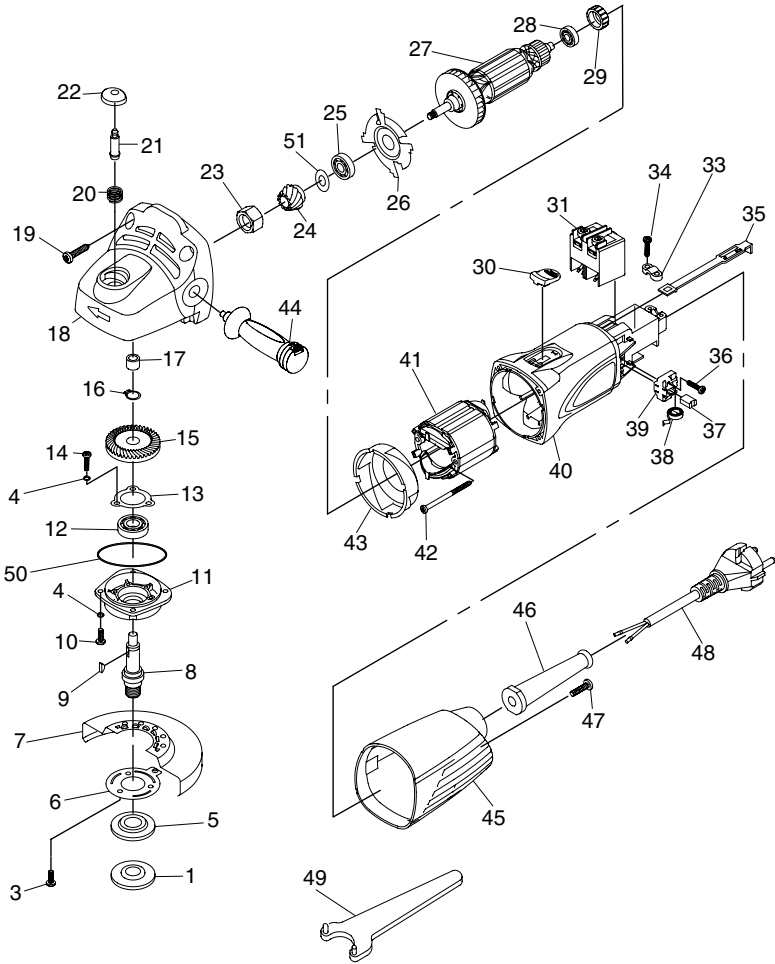

**Parts breakdown provided for reference only.  
Not all parts shown are available for purchase.**

# T10493 Main Parts List

REF	PART #	DESCRIPTION
1	PT10493001	OUTER FLANGE
3	PS110M	PHLP HD SCR M4-.7 X 8
4	PS07M	FLAT WASHER 4MM
5	PT10493005	INNER FLANGE
6	PT10493006	GUARD PLATE
7	PT10493007	WHEEL GUARD 4"
8	PT10493008	OUTPUT SPINDLE 3/8"-16
9	PT10493009	WOODRUFF KEY 3 X 10
10	PS02M	PHLP HD SCR M4-.7 X 12
11	PT10493011	FRONT COVER
12	P6001ZZ	BALL BEARING 6001ZZ
13	PT10493013	BEARING PLATE
14	PS07M	PHLP HD SCR M4-.7 X 8
15	PT10493015	GEAR
16	PRO1M	EXT RETAINING RING 10MM
17	PT10446003	NEEDLE BEARING HK0810
18	PT10493018	FRONT HOUSING
19	PHTEK8M	TAP SCREW M4 X 20
20	PT10493020	COMPRESSION SPRING
21	PT10493021	SELF-LOCKING PIN
22	PT10493022	SELF-LOCKING BUTTON
23	PT10493023	PINION NUT
24	PT10493024	TAPER PINION
25	P609ZZ	BALL BEARING 609ZZ
26	PT10493026	BAFFLE

REF	PART #	DESCRIPTION
27	PT10493027	ARMATURE
28	P607ZZ	BALL BEARING 607ZZ
29	PT10493029	BEARING SLEEVE
30	PT10493030	SWITCH BUTTON
31	PT10493031	ON/OFF SWITCH
33	PT10493033	CABLE CLAMP
34	PHTEK5M	TAP SCREW M4 X 12
35	PT10493035	SWITCH DRAW LEVER
36	PHTEK18M	TAP SCREW M3.5 X 10
37	PT10493037	CARBON BRUSH
38	PT10493038	FLAT COIL SPRING
39	PT10493039	CARBON BRUSH HOLDER
40	PT10493040	HOUSING
41	PT10493041	STATOR
42	PHTEK54M	TAP SCREW M4.2 X 65
43	PT10493043	FAN GUIDE BAFFLE
44	PT10493044	HANDLE
45	PT10493045	BRUSH COVER
46	PT10493046	CABLE ARMOR
47	PHTEK6M	TAP SCREW M4 X 16
48	PT10493048	POWER CORD 16G 2W 72" 1-15
49	PT10493049	FIXED PIN SPANNER WRENCH
50	PT10493050	O-RING
51	PT10493051	OIL SEALING PLATE

# T10493 Labels Breakdown



REF	PART #	DESCRIPTION
52	PT10493051	MODEL ID LABEL
53	PT10493052	GRIZZLY LABEL

REF	PART #	DESCRIPTION
54	PT10493053	SAFETY LABEL

# WARRANTY

---

---

Grizzly Industrial, Inc. warrants every product it sells for a period of **1 year** to the original purchaser from the date of purchase. This warranty does not apply to defects due directly or indirectly to misuse, abuse, negligence, accidents, repairs or alterations or lack of maintenance. This is Grizzly's sole written warranty and any and all warranties that may be implied by law, including any merchantability or fitness, for any particular purpose, are hereby limited to the duration of this written warranty. We do not warrant or represent that the merchandise complies with the provisions of any law or acts unless the manufacturer so warrants. In no event shall Grizzly's liability under this warranty exceed the purchase price paid for the product and any legal actions brought against Grizzly shall be tried in the State of Washington, County of Whatcom.

We shall in no event be liable for death, injuries to persons or property or for incidental, contingent, special, or consequential damages arising from the use of our products.

To take advantage of this warranty, contact us by mail or phone and give us all the details. We will then issue you a "Return Number," which must be clearly posted on the outside as well as the inside of the carton. We will not accept any item back without this number. Proof of purchase must accompany the merchandise.

The manufacturers reserve the right to change specifications at any time because they constantly strive to achieve better quality equipment. We make every effort to ensure that our products meet high quality and durability standards and we hope you never need to use this warranty.

Please feel free to write or call us if you have any questions about the machine or the manual.

Thank you again for your business and continued support. We hope to serve you again soon.

**grizzly.com**<sup>®</sup>  
**TOOL WEBSITE**

**Buy Direct and Save with Grizzly<sup>®</sup> – Trusted, Proven and a Great Value!**  
*~Since 1983~*

***Visit Our Website Today For  
Current Specials!***

**ORDER  
24 HOURS A DAY!  
1-800-523-4777**





## Free Manuals Download Website

<http://myh66.com>

<http://usermanuals.us>

<http://www.somanuals.com>

<http://www.4manuals.cc>

<http://www.manual-lib.com>

<http://www.404manual.com>

<http://www.luxmanual.com>

<http://aubethermostatmanual.com>

Golf course search by state

<http://golfingnear.com>

Email search by domain

<http://emailbydomain.com>

Auto manuals search

<http://auto.somanuals.com>

TV manuals search

<http://tv.somanuals.com>