

Grizzly *Industrial, Inc.*®

BUFFING SYSTEM MODEL G1061/G1061Z INSTRUCTION MANUAL

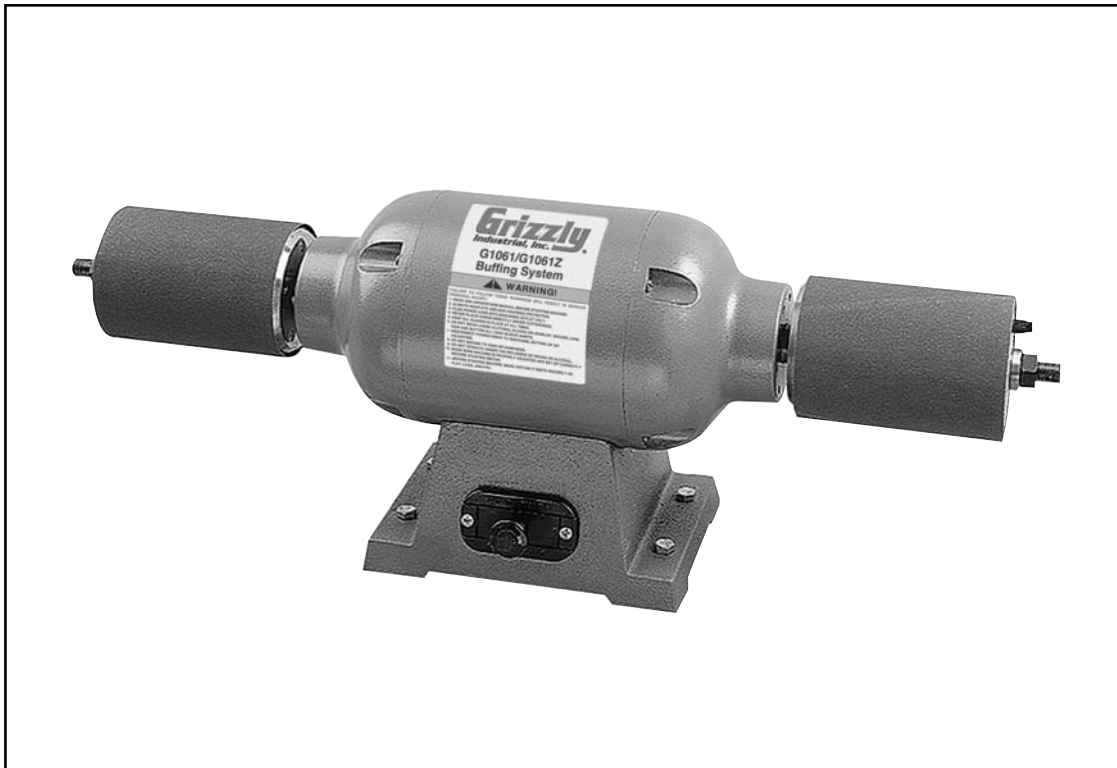

COPYRIGHT © 1992 BY GRIZZLY INDUSTRIAL, INC.
**WARNING: NO PORTION OF THIS MANUAL MAY BE REPRODUCED IN ANY SHAPE
OR FORM WITHOUT THE WRITTEN APPROVAL OF GRIZZLY INDUSTRIAL, INC.**
JANUARY, 2002 PRINTED IN TAIWAN.

WARNING

Some dust created by power sanding, sawing, grinding, drilling, and other construction activities contains chemicals known to the State of California to cause cancer, birth defects or other reproductive harm. Some examples of these chemicals are:

- Lead from lead-based paints.
- Crystalline silica from bricks, cement, and other masonry products.
- Arsenic and chromium from chemically treated lumber.

Your risk from these exposures varies, depending on how often you do this type of work. To reduce your exposure to these chemicals: work in a well ventilated area, and work with approved safety equipment, such as those dust masks that are specially designed to filter out microscopic particles.

Table Of Contents

	PAGE
1. SAFETY	
SAFETY RULES FOR POWER TOOLS	2-3
ADDITIONAL SAFETY INSTRUCTIONS FOR BUFFERS	4
2. CIRCUIT REQUIREMENTS	
110V OPERATION	5
EXTENSION CORDS	5
GROUNDING	5
3. INTRODUCTION	
COMMENTARY	6
MOUNTING	7
6. OPERATIONS	
TEST RUN	8
GENERAL	8
BUFFING & POLISHING	9
DRUM SANDING	9-10
ACCESSORY REMOVAL	10
7. MAINTENANCE	
LUBRICATION	11
MISCELLANEOUS	11
8. CLOSURE	12
MACHINE DATA	13
PARTS BREAKDOWN AND PARTS LIST	14
NOTES	15
WARRANTY AND RETURNS	16

SECTION 1: SAFETY

WARNING

For Your Own Safety Read Instruction Manual Before Operating This Equipment

The purpose of safety symbols is to attract your attention to possible hazardous conditions. This manual uses a series of symbols and signal words which are intended to convey the level of importance of the safety messages. The progression of symbols is described below. Remember that safety messages by themselves do not eliminate danger and are not a substitute for proper accident prevention measures.



Indicates an imminently hazardous situation which, if not avoided, **WILL** result in death or serious injury.



Indicates a potentially hazardous situation which, if not avoided, **COULD** result in death or serious injury.



Indicates a potentially hazardous situation which, if not avoided, **MAY** result in minor or moderate injury. It may also be used to alert against unsafe practices.

NOTICE

This symbol is used to alert the user to useful information about proper operation of the equipment.

WARNING

Safety Instructions For Power Tools

1. **KEEP GUARDS IN PLACE** and in working order.
2. **REMOVE ADJUSTING KEYS AND WRENCHES.** Form habit of checking to see that keys and adjusting wrenches are removed from tool before turning on.
3. **KEEP WORK AREA CLEAN.** Cluttered areas and benches invite accidents.
4. **DO NOT USE IN DANGEROUS ENVIRONMENT.** Do not use power tools in damp or wet locations, or where any flammable or noxious fumes may exist. Keep work area well lighted.
5. **KEEP CHILDREN AND VISITORS AWAY.** All children and visitors should be kept a safe distance from work area.
6. **MAKE WORKSHOP CHILD PROOF** with padlocks, master switches, or by removing starter keys.
7. **DO NOT FORCE TOOL.** It will do the job better and safer at the rate for which it was designed.
8. **USE RIGHT TOOL.** Do not force tool or attachment to do a job for which it was not designed.

WARNING

Safety Instructions For Power Tools

- 9. USE PROPER EXTENSION CORD.** Make sure your extension cord is in good condition. Conductor size should be in accordance with the chart below. The amperage rating should be listed on the motor or tool nameplate. An undersized cord will cause a drop in line voltage resulting in loss of power and overheating. Your extension cord must also contain a ground wire and plug pin. Always repair or replace extension cords if they become damaged.

Minimum Gauge for Extension Cords

AMP RATING	LENGTH		
	25ft	50ft	100ft
0-6	18	16	16
7-10	18	16	14
11-12	16	16	14
13-16	14	12	12
17-20	12	12	10
21-30	10	10	No

- 10. WEAR PROPER APPAREL.** Do not wear loose clothing, gloves, neckties, rings, bracelets, or other jewelry which may get caught in moving parts. Non-slip footwear is recommended. Wear protective hair covering to contain long hair.
- 11. ALWAYS USE SAFETY GLASSES.** Also use face or dust mask if cutting operation is dusty. Everyday eyeglasses only have impact resistant lenses, they are NOT safety glasses.
- 12. SECURE WORK.** Use clamps or a vise to hold work when practical. It's safer than using your hand and frees both hands to operate tool.
- 13. DO NOT OVER-REACH.** Keep proper footing and balance at all times.
- 14. MAINTAIN TOOLS WITH CARE.** Keep tools sharp and clean for best and safest performance. Follow instructions for lubricating and changing accessories.
- 15. USE RECOMMENDED ACCESSORIES.** Consult the owner's manual for recommended accessories. The use of improper accessories may cause risk of injury.
- 16. REDUCE THE RISK OF UNINTENTIONAL STARTING.** On machines with magnetic contact starting switches there is a risk of starting if the machine is bumped or jarred. Always disconnect from power source before adjusting or servicing. Make sure switch is in OFF position before reconnecting.
- 17. MANY WOODWORKING TOOLS CAN "KICKBACK" THE WORKPIECE** toward the operator if not handled properly. Know what conditions can create "kickback" and know how to avoid them. Read the manual accompanying the machine thoroughly.
- 18. CHECK DAMAGED PARTS.** Before further use of the tool, a guard or other part that is damaged should be carefully checked to determine that it will operate properly and perform its intended function. Check for alignment of moving parts, binding of moving parts, breakage of parts, mounting, and any other conditions that may affect its operation. A guard or other part that is damaged should be properly repaired or replaced.
- 19. NEVER LEAVE TOOL RUNNING UNATTENDED. TURN POWER OFF.** Do not leave tool until it comes to a complete stop.
- 20. NEVER OPERATE A MACHINE WHEN TIRED, OR UNDER THE INFLUENCE OF DRUGS OR ALCOHOL.** Full mental alertness is required at all times when running a machine.
- 21. NEVER ALLOW UNSUPERVISED OR UNTRAINED PERSONNEL TO OPERATE THE MACHINE.** Make sure any instructions you give in regards to machine operation are approved, correct, safe, and clearly understood.
- 22. IF AT ANY TIME YOU ARE EXPERIENCING DIFFICULTIES** performing the intended operation, stop using the machine! Then contact our service department or ask a qualified expert how the operation should be performed.

WARNING

Additional Safety Instructions For Buffers

- 1. ALWAYS WEAR EYE PROTECTION!**
- 2. WEAR AN APPROVED DUST MASK OR RESPIRATOR.** Buffing operations produce dust.
- 3. MAKE SURE BUFFER IS SECURED FIRMLY TO A BENCH OR STAND BEFORE USE.** Any “wobbles” must be corrected by shimming or blocking before operation.
- 4. DO NOT USE GRINDING WHEELS ON THIS MACHINE.** It is strictly designed for buffing and drum sanding only.
- 5. DO NOT** stand directly in front of buffing or sanding accessories when turning machine on.
- 6. PERFORM** machine inspections and maintenance service promptly when called for.
- 7. DO NOT** allow your hands to come into contact with sanding drums or buffing wheels during operation. Abrasive accessories have the ability to remove a lot of material, including skin, very quickly.
- 8. ANY PROBLEM** concerned with any moving parts or accessories must be investigated and corrected with the power disconnected, and after everything has come to a complete stop.
- 9. NEVER** leave the machine running unattended.
- 10. NEVER BUFF OR SAND BY PLACING THE WORKPIECE ON TOP OF THE WHEEL.** The wheel may kick the workpiece toward the operator. Always buff on the downward part of the wheel.
- 11. HOLD THE WORKPIECE FIRMLY WHILE BUFFING OR SANDING.**

WARNING

To operate this or any power tool safely and efficiently, it is essential to become as familiar with it as possible. The time you invest before you begin to use your Model G1061/G1061Z will be time well spent. **DO NOT** operate this machine until you are completely familiar with the contents of this manual or serious personal injury may occur.

CAUTION

No list of safety guidelines can be complete. Every shop environment is different. Always consider safety first, as it applies to your individual working conditions. Use this and other machinery with caution and respect. Failure to follow guidelines could result in serious personal injury, damage to equipment or poor work results.

SECTION 2: CIRCUIT REQUIREMENTS

110V Operation

The Model G1061/G1061Z is wired for 110/120V. The 1 H.P. motor will safely draw 10 amps at 110V. If you operate this machine on any circuit that is already close to its capacity, it might blow a fuse or trip a circuit breaker. However, if an unusual load does not exist and a power failure still occurs, contact a qualified electrician or our service department.

A 15 amp dedicated circuit should be used with this buffer. Always check to see if your current wires are capable of handling a 15 amp load. If you are unsure, consult the advice of a qualified electrician.



Extension Cords

If you find it necessary to use an extension cord with the Model G1061/G1061Z, make sure the cord is rated Hard Service (grade S) or better. Refer to the chart in the standard safety instructions to determine the minimum gauge for the extension cord. The extension cord must also contain a ground wire and plug pin. Always repair or replace extension cords when they become worn or damaged.



Grounding

In the event of an electrical short, grounding reduces the risk of electric shock by providing electric current a path of least resistance. This tool is equipped with a power cord having an equipment-grounding conductor. **See Figure 1B.** The outlet must be properly installed and grounded in accordance with all local codes and ordinances.

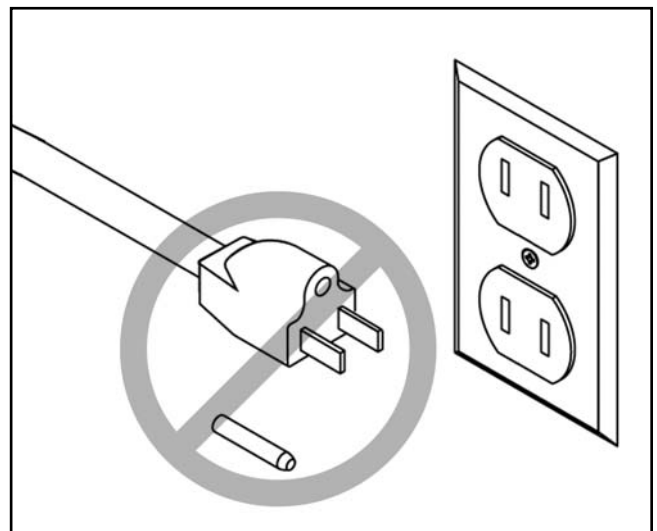
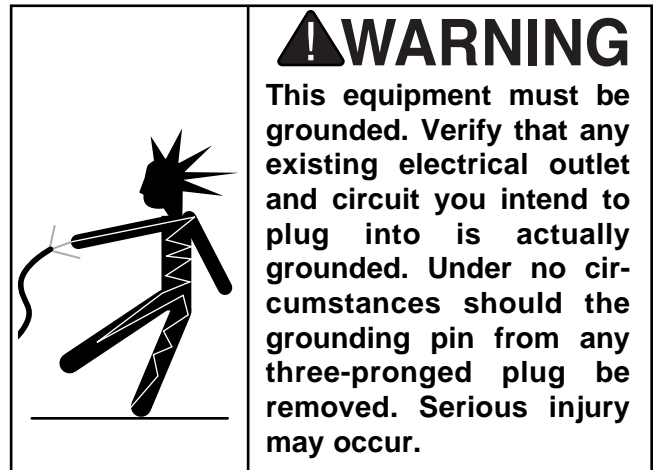

Figure 1A. Do not remove grounding pin.

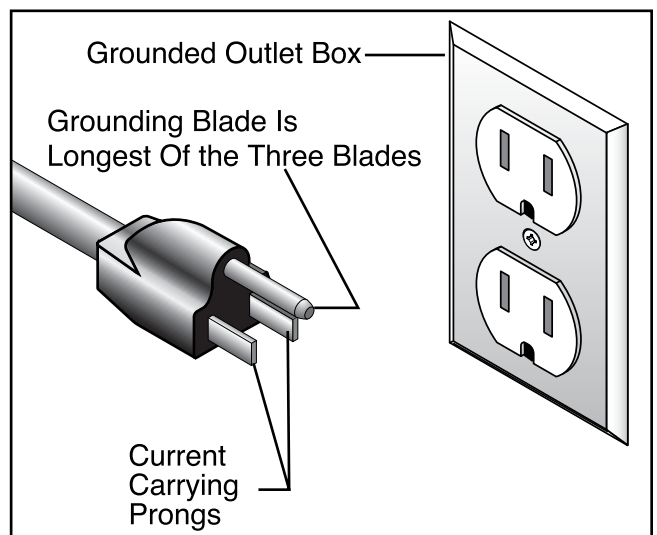

Figure 1B. Typical 110V plug and outlet.



SECTION 3: INTRODUCTION

Commentary

We are proud to offer the Grizzly Model G1061/G1061Z Buffing System. The Model G1061/G1061Z is part of a growing Grizzly family of fine woodworking machinery. When used according to the guidelines set forth in this manual, you can expect years of trouble-free, enjoyable operation and proof of Grizzly's commitment to customer satisfaction.

Specifically, the Model G1061 offers a 3450 R.P.M. motor, and the Model G1061Z offers a 1725 R.P.M. motor. Both models feature 1 H.P. motors and 1" diameter shafts that extend 8" on both sides.

A number of buffing wheels and sanding drums for the Model G1061/G1061Z are available through the Grizzly catalog.

We are also pleased to provide this manual with the Model G1061/G1061Z. It was written to guide you through assembly, review safety considerations, and cover general operating procedures. It represents our effort to produce the best documentation possible. If you have any comments regarding this manual, please write to us at the address below:

Grizzly Industrial, Inc.
c/o Technical Documentation
P.O. Box 2069
Bellingham, WA 98227-2069

Most importantly, we stand behind our machines. If you have any service questions or parts requests, please call or write us at the location listed below:

Grizzly Industrial, Inc.
1203 Lycoming Mall Circle
Muncy, PA 17756
Phone: (570) 546-9663
Fax: (800) 438-5901
E-Mail: techsupport@grizzly.com
Web Site: <http://www.grizzly.com>

The specifications, drawings, and photographs illustrated in this manual represent the Model G1061/G1061Z as supplied when the manual was prepared. However, owing to Grizzly's policy of continuous improvement, changes may be made at any time with no obligation on the part of Grizzly. Whenever possible, though, we send manual updates to all owners of a particular tool or machine. Should you receive one, we urge you to insert the new information with the old and keep it for reference.

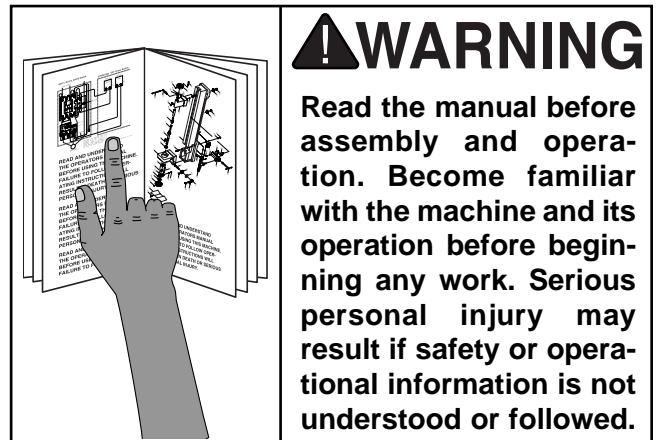

Unpacking

The Model G1061/G1061Z is shipped from the manufacturer in a carefully packed carton. If you discover the machine is damaged after you have signed for delivery, immediately call Customer Service for advice.

When you are completely satisfied with the condition of your shipment, you should inventory its parts.

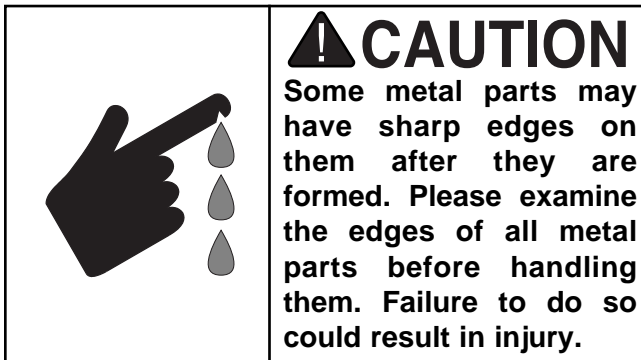

Piece Inventory

After all the parts have been removed from the carton, you should have:

- Buffing Unit
- Wheel Flanges (4)

NOTICE

A full parts list and breakdown can be found toward the end of this manual. For easier assembly, or to identify specific parts, please refer to the detailed illustrations at the end of the manual.



Mounting

The Model G1061/G1061Z weighs approximately 59 lbs. Make sure the workbench on which you plan to mount the buffer is sturdy enough to hold the weight of the machine and any downward pressure that may be applied during operation. The workbench should have a level surface and be heavy, or attached to the floor, so it will not move during operation. To mount the buffer:

1. Pick a spot on the workbench that will allow enough room to move the size of an anticipated workpiece around the buffer. The operator (and possibly bystanders) should have enough room to stand out of the way in an emergency.
2. Mount the buffer to the workbench with bolts that are long enough to exceed the thickness of your workbench and the buffer base. Secure these bolts with a flat washers, a lock washer and a hex nut. *Because sizes vary for each individual situation, the hardware in this step is not included with the Model G1061/G1061Z.*
3. Mount the buffer in an area with proper lighting and near electrical outlets. Lighting should be bright enough to eliminate shadow and prevent eye strain. Electrical circuits should be dedicated or large enough to handle amperage requirements. Keep power or extension cords clear of high-traffic areas. Observe local electrical codes for proper installation of new lighting, outlets, or circuits.

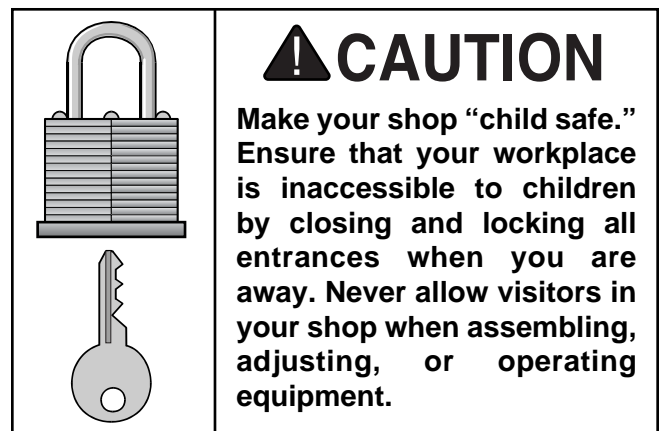

SECTION 6: OPERATIONS

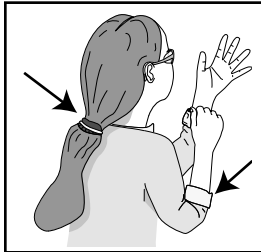

⚠️ WARNING

Keep loose clothing rolled up and out of the way of machinery and keep hair pulled back.

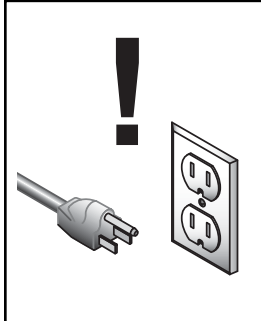

⚠️ WARNING

Disconnect power to the machine when performing any maintenance, assembly or adjustments. Failure to do this may result in serious personal injury.

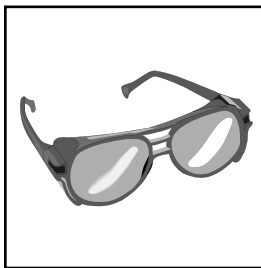

⚠️ WARNING

Wear safety glasses during the entire operation process. Failure to comply may result in serious personal injury.

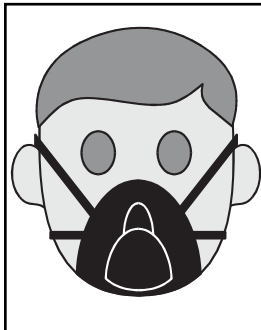

⚠️ CAUTION

Using this machine produces sawdust which may cause allergic reactions and respiratory problems. Use an approved dust mask to protect yourself from these hazards!

NOTICE

The following section was designed to give instructions on the basic operations of this buffer. However, it is in no way comprehensive of every buffer application. There are many different buffing wheels, sanding drums and attachments available for buffers. **WE STRONGLY RECOMMEND** that you read books, trade magazines, or get formal training to maximize the potential of your machine.

Test Run

Once mounting is complete and adjustments are done to your satisfaction, you are ready to test the machine.

Turn on the power supply at the main panel. Make sure that your hand is poised near the switch in case there is a problem. The buffer should run smoothly with little or no vibration or rubbing noises. Strange or unnatural noises should be investigated and corrected before operating the machine further.

If you cannot easily locate the source of an unusual noise or vibration, feel free to contact our service department for help.



General

The Model G1061/G1061Z Buffing System is strictly designed for buffing and sanding operations. **IT IS NOT A GRINDER.** The absence of grinding wheel guards prohibit the use of this machine as a grinder.

This buffer has a left and right shaft to provide the option of mounting two different sanding or buffing accessories, depending on your application. The convenience of having two shafts allows you to mount different grits of sandpaper or different textured buffing wheels onto each shaft.



Buffing & Polishing

For buffing and polishing, Grizzly offers a broad line of buffing wheels and polishing compounds. Please refer to our current catalog. To buff or polish:

1. Make sure the power cord is unplugged and remove the 1 $\frac{3}{8}$ " hex nuts at the end of each shaft. Facing the machine, the left-hand shaft has left-handed threads. The right-hand shaft has right-handed threads.
2. Sandwich an optional buffing wheel between the two wheel flanges provided and slide the assembly onto the shaft. Use only the wheel flanges supplied with this machine. The buffing assembly should look similar to **Figure 1**.



Figure 1. Buffing wheels mounted.

3. Tighten the hex nut while holding the shaft with your other hand. The direction of the threads and motor rotation ensure that the nuts on both sides will not self loosen.
4. Select the appropriate stick of polishing compound for your application and apply to the rotating face of the wheel. Always wear safety glasses because particles of polishing compound or buffing wheel may fly off.

⚠ CAUTION

Never sand or buff with the workpiece on top of the wheel. The workpiece may be catch the wheel and be thrown at the operator. Always process the workpiece near the bottom of the wheel!

5. Start the buffer and with both hands firmly grasp the item to be polished. Lightly and evenly move the workpiece back and forth on the buffing wheel. Be careful when polishing plated metals; there is a chance that the thin plated material may be damaged. A light pressure is all that is needed for quality work.



Drum Sanding

To sand using the optional sanding drums:

1. Make sure the power cord is unplugged and remove the 1 $\frac{3}{8}$ " hex nuts at the end of each shaft.
2. Slide the sanding drum onto the shaft so that the valve end is near the end of the shaft and secure the nut. Wheel flanges are not necessary to use with sanding drums.
3. Slide the sanding sleeve onto the drum. Ensure that the arrows on the inside of the sleeve point in the direction of the drum rotation. If there are no arrows inside the sleeve, slide the sleeve onto the drum so that the overlap is positioned correctly in relation to the drum rotation as shown in **Figure 2**.

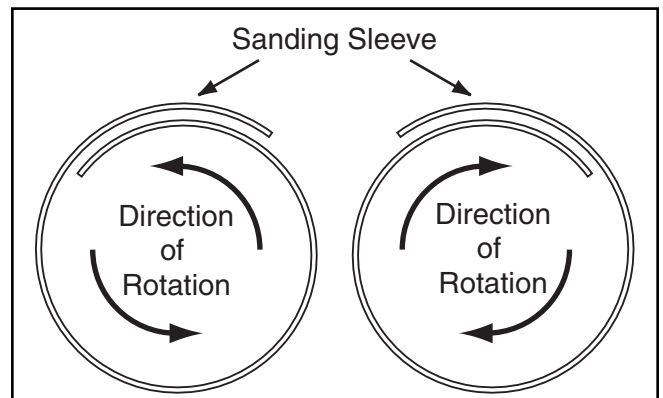

Figure 2. Sanding sleeve overlap direction.

- Inflate the drum using a bicycle pump or air compressor. The maximum air pressure is 10 psi. **DO NOT OVER-INFLATE!** We recommend against filling the drum with an air compressor. When sanding drums have been installed, the assembly should look similar to **Figure 3**.



Figure 3. Sanding drums installed.

- Pull out on the switch to turn the machine on and firmly grasp the workpiece to be sanded.
- With light and even pressure against the direction of rotation, move the workpiece back and forth on the sanding drum. Sand in the direction of the wood grain. Always wear safety glasses and a dust mask.

CAUTION

Never sand or buff with the workpiece on top of the wheel. The workpiece may catch the wheel and be thrown at the operator. Always process the workpiece near the bottom of the wheel!



Accessory Removal

To remove the buffing or sanding attachments, ensure that the switch is pushed in and the power cord is disconnected. With buffing wheels mounted, hold the shaft with one hand while loosening the nut with a wrench. If both shafts are concealed by sanding drums, use a wrench to loosen the desired nut while holding onto the sanding drum. If the drum slips while loosening the nut, hold onto the opposite sanding drum. Remember, the left-hand nut and shaft have left-handed threads.

Figure 4 shows the loosening/tightening procedure for buffing wheels. **Figure 5** shows the loosening/tightening procedure for sanding drums.



Figure 4. Buffing wheel loosening/tightening procedure.



Figure 5. Sanding drum loosening/tightening procedure.



SECTION 7: MAINTENANCE

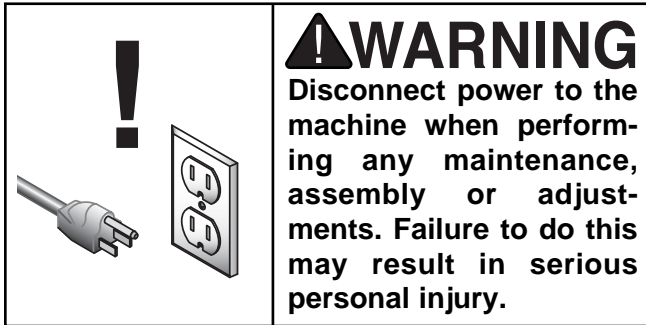

Lubrication

Shielded and pre-lubricated ball bearings require no lubrication for the life of the bearings. All bearings are standard sizes, and replacements can be purchased from our parts department or a bearing supply store.



Miscellaneous

Always be aware of the condition of your buffer. Routinely check the condition of the following items and repair or replace as necessary:

- Loose mounting bolts
- Worn switch
- Worn or damaged cord
- Worn or damaged support bearings or guide bearings



SECTION 8: CLOSURE

The following pages contain general machine data, parts diagrams/lists, a troubleshooting guide and Warranty/Return information for your Model G1061/G1061Z.

If you need parts or help in assembling your machine, or if you need operational information, we encourage you to call our Service Department. Our trained service technicians will be glad to help you.

If you have comments dealing specifically with this manual, please write to our Bellingham, Washington location using the address in **Section 3: Introduction**.

We have included some important safety measures that are essential to this machine's operation. While most safety measures are generally universal, Grizzly reminds you that each workshop is different and safety rules should be considered as they apply to your specific situation.

WARNING

Operating this equipment creates the potential for flying debris to cause eye injury. Always wear safety glasses or goggles when operating equipment. Everyday glasses or reading glasses only have impact resistant lenses, they are not safety glasses. Be certain the safety glasses you wear meet the appropriate standards of the American National Standards Institute (ANSI).



We recommend you keep a copy of our current catalog for complete information regarding Grizzly's warranty and return policy. If you need additional technical information relating to this machine, or if you need general assistance or replacement parts, please contact the Service Department listed in **Section 3: Introduction**.

Additional information sources are necessary to realize the full potential of this machine. Trade journals, woodworking magazines, and your local library are good places to start.

WARNING

The Model G1061/G1061Z was specifically designed for buffing and sanding. **DO NOT MODIFY AND/OR USE THIS MACHINE FOR ANY OTHER PURPOSE.** Modifications or improper use of this tool will void the warranty. If you are confused about any aspect of this machine, **DO NOT** use it until all your questions have been answered or serious personal injury may occur.

WARNING

Like all power tools, there is danger associated with the Model G1061/G1061Z. Accidents are frequently caused by lack of familiarity or failure to pay attention. Use this tool with respect and caution to lessen the possibility of operator injury. If normal safety precautions are overlooked or ignored, serious personal injury may occur.





MACHINE DATA SHEET

Customer Service #: (570) 546-9663 • To Order Call: (800) 523-4777 • Fax #: (800) 438-5901

GRIZZLY MODEL G1061/G1061Z BUFFING MACHINE

Design Type..... Bench Model

Overall Dimensions:

Height 11¼"
 Width..... 31½"
 Depth 7½"
 Shipping Weight 59 lbs.
 Net Weight 53 lbs.
 Box Size..... 32" L x 15" W x 16" H
 Footprint 10" x 7"

Shaft:

Main 1" x 6"
 Buffing Wheel Mount 5/8" x 2"
 Total Length Each 8"

Motor:

Type TEFC Capacitor-Start Induction
 Horsepower..... 1 H.P.
 Phase / Voltage Single Phase / 110V
 Amps..... 10
 Cycle 60 Hertz
 G1061 Motor Speed 3450 R.P.M.
 G1061Z Motor Speed 1725 R.P.M.
 Bearings Sealed & Permanently Lubricated
 Switch Push / Pull

Features:

.....Includes: Wheel Flanges

Specifications, while deemed accurate, are not guaranteed.

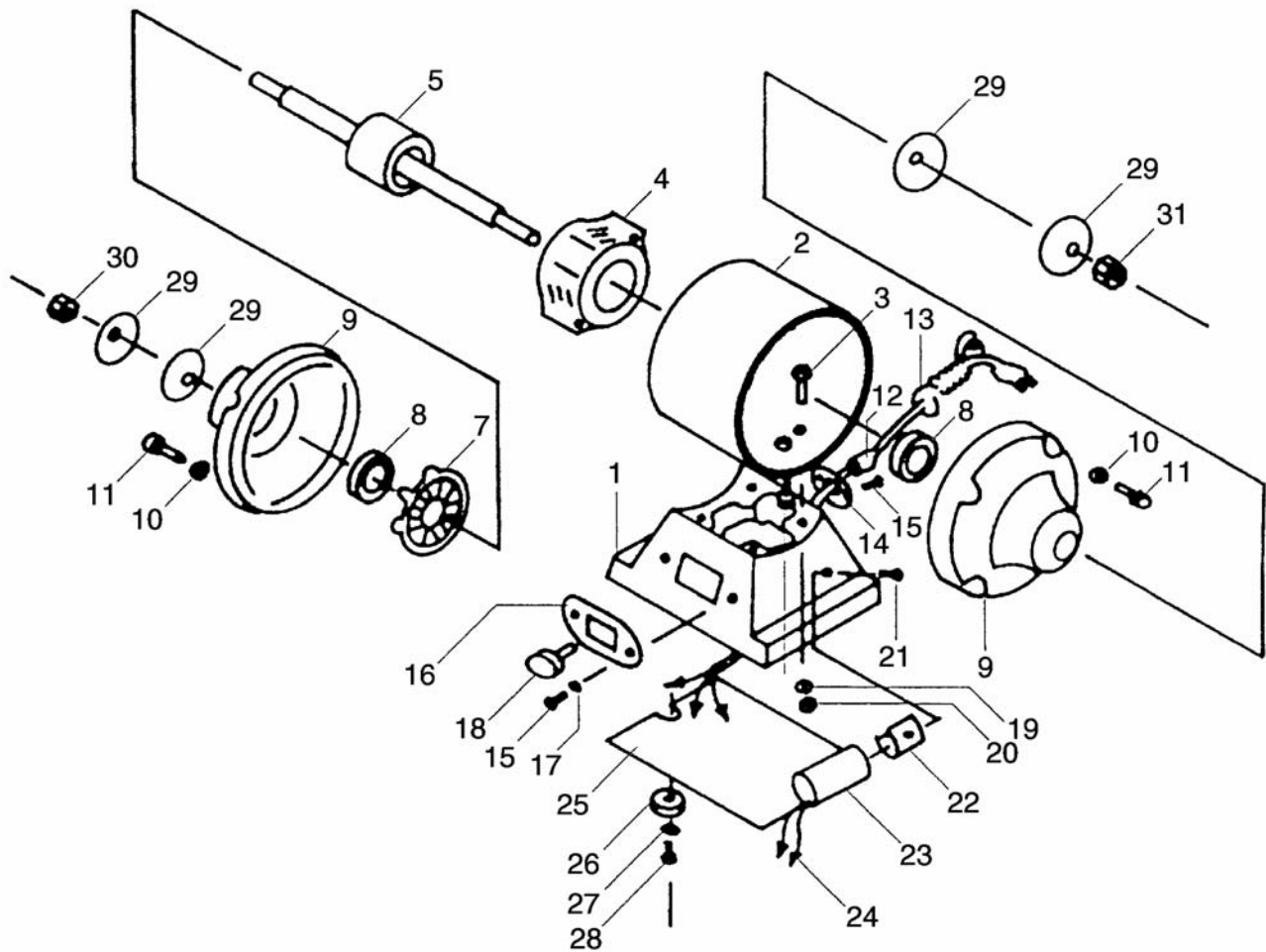

Ref#	Part#	Description
001	P1061001	MOTOR BASE
002	P1061002	MOTOR CASE
003	PFH07	FLAT HD SCR $\frac{5}{16}$ "-18 X $1\frac{1}{4}$ "
004	P1061004	STATOR (G1061)
004	P1061Z004	STATOR (G1061Z)
005	P1061005	ROTOR W/#6 (G1061)
005	P1061Z005	ROTOR (G1061Z)
007	P1061007	MOTOR FAN
008	P6206	BALL BEARING 6206ZZ
009	P1061009	END BELL
010	PLW02	LOCK WASHER $\frac{1}{4}$ "
011	PS12	PHLP HD SCR $\frac{1}{4}$ -20 X $\frac{5}{8}$ "
012	P1015017	CORD CLAMP
013	P1015019	POWER CORD
014	P1015017-1	STRAIN RELIEF
015	PS01	PHLP HD SCR 10-24 X $\frac{1}{2}$ "

Ref#	Part#	Description
016	P1061016	PANEL SWITCH
017	PLW03	LOCK WASHER $\frac{3}{16}$ "
018	P1061018	ON/OFF SWITCH
019	PLW01	LOCK WASHER $\frac{5}{16}$ "
020	PN02	HEX NUT $\frac{5}{16}$ "-18
021	PHTEK1	SELF TAP PHLP HD SCR
022	P1061022	CLAMP
023	PC400	CAPACITOR
024	P1061024	CLAMP CORD
025	P1061025	FLOOR PLATE
026	P1061026	FOOT WASHER
027	PW03	FLAT WASHER $\frac{3}{16}$ "
028	PS01	PHLP HD SCR 10-24 X $\frac{1}{2}$ "
029	P1061029	WHEEL FLANGE
030	P1061030	LEFT HND HEX NUT
031	P1061031	RIGHT HND HEX NUT

NOTES:



WARRANTY AND RETURNS

Grizzly Industrial, Inc. warrants every product it sells for a period of **1 year** to the original purchaser from the date of purchase. This warranty does not apply to defects due directly or indirectly to misuse, abuse, negligence, accidents, repairs or alterations or lack of maintenance. This is Grizzly's sole written warranty and any and all warranties that may be implied by law, including any merchantability or fitness, for any particular purpose, are hereby limited to the duration of this written warranty. We do not warrant or represent that the merchandise complies with the provisions of any law or acts unless the manufacturer so warrants. In no event shall Grizzly's liability under this warranty exceed the purchase price paid for the product and any legal actions brought against Grizzly shall be tried in the State of Washington, County of Whatcom.

We shall in no event be liable for death, injuries to persons or property or for incidental, contingent, special, or consequential damages arising from the use of our products.

To take advantage of this warranty, contact us by mail or phone and give us all the details. We will then issue you a "Return Number," which must be clearly posted on the outside as well as the inside of the carton. We will not accept any item back without this number. Proof of purchase must accompany the merchandise.

The manufacturers reserve the right to change specifications at any time because they constantly strive to achieve better quality equipment. We make every effort to ensure that our products meet high quality and durability standards and we hope you never need to use this warranty.

Please feel free to write or call us if you have any questions about the machine or the manual.

Thank you again for your business and continued support. We hope to serve you again soon.

WARRANTY CARD

Name _____
Street _____
City _____ State _____ Zip _____
Phone Number _____ E-Mail _____ FAX _____
MODEL # G1061/G1061Z Buffing System Order # _____

The following information is given on a voluntary basis. It will be used for marketing purposes to help us develop better products and services. Of course, all information is strictly confidential.

- How did you learn about us?
 Advertisement Friend
 Catalog Card Deck
 World Wide Web
 Other _____
- Which of the following magazines do you subscribe to.
 American Woodworker Practical Homeowner
 Cabinetmaker Shop Notes
 Family Handyman Today's Homeowner
 Fine Homebuilding WOOD
 Fine Woodworking Wooden Boat
 Home Handyman Woodshop News
 Journal of Light Construction Woodsmith
 Old House Journal Woodwork
 Popular Mechanics Woodworker
 Popular Science Woodworker's Journal
 Popular Woodworking Workbench
 Other _____
- Which of the following woodworking/remodeling shows do you watch?
 Backyard America The New Yankee Workshop
 Home Time This Old House
 The American Woodworker Woodwright's Shop
 Other _____
- What is your annual household income?
 \$20,000-\$29,999 \$60,000-\$69,999
 \$30,000-\$39,999 \$70,000-\$79,999
 \$40,000-\$49,999 \$80,000-\$89,999
 \$50,000-\$59,999 \$90,000 +
- What is your age group?
 20-29 50-59
 30-39 60-69
 40-49 70 +
- How long have you been a woodworker?
 0 - 2 Years 8 - 20 Years
 2 - 8 Years 20+ Years
- How would you rank your woodworking skills?
 Simple Advanced
 Intermediate Master Craftsman
- What stationary woodworking tools do you own? Check all that apply.
 Air Compressor Panel Saw
 Band Saw Planer
 Drill Press Power Feeder
 Drum Sander Radial Arm Saw
 Dust Collector Shaper
 Horizontal Boring Machine Spindle Sander
 Jointer Table Saw
 Lathe Vacuum Veneer Press
 Mortiser Wide Belt Sander
 Other _____
- How many of your woodworking machines are Grizzly? _____
- Which benchtop tools do you own? Check all that apply.
 1" x 42" Belt Sander 6" - 8" Grinder
 5" - 8" Drill Press Mini Lathe
 8" Table Saw 10" - 12" Thickness Planer
 8" - 10" Bandsaw Scroll Saw
 Disc/Belt Sander Spindle/Belt Sander
 Mini Jointer
 Other _____
- How many of the machines checked above are Grizzly? _____
- Which portable/hand held power tools do you own? Check all that apply.
 Belt Sander Orbital Sander
 Biscuit Joiner Palm Sander
 Circular Saw Portable Planer
 Detail Sander Saber Saw
 Drill/Driver Reciprocating Saw
 Miter Saw Router
 Other _____
- What machines/supplies would you like Grizzly Industrial to carry?

- What new accessories would you like Grizzly Industrial to carry?

- What other companies do you purchase your tools and supplies from?

- Do you think your purchase represents good value?
 Yes No
- Would you recommend Grizzly Industrial to a friend?
 Yes No
- Would you allow us to use your name as a reference for Grizzly customers in your area? **Note: We never use names more than three times.**
 Yes No
- Comments: _____

FOLD ALONG DOTTED LINE

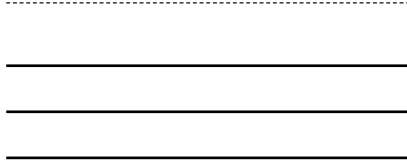

Place
Stamp
Here



GRIZZLY INDUSTRIAL, INC.
P.O. BOX 2069
BELLINGHAM, WA 98227-2069



FOLD ALONG DOTTED LINE

Send a Grizzly Catalog to a friend:

Name _____
Street _____
City _____ State _____ Zip _____

TAPE ALONG EDGES--PLEASE DO NOT STAPLE

Free Manuals Download Website

<http://myh66.com>

<http://usermanuals.us>

<http://www.somanuals.com>

<http://www.4manuals.cc>

<http://www.manual-lib.com>

<http://www.404manual.com>

<http://www.luxmanual.com>

<http://aubethermostatmanual.com>

Golf course search by state

<http://golfingnear.com>

Email search by domain

<http://emailbydomain.com>

Auto manuals search

<http://auto.somanuals.com>

TV manuals search

<http://tv.somanuals.com>