

Grizzly Industrial®

CHAIN SAW FILING GUIDE

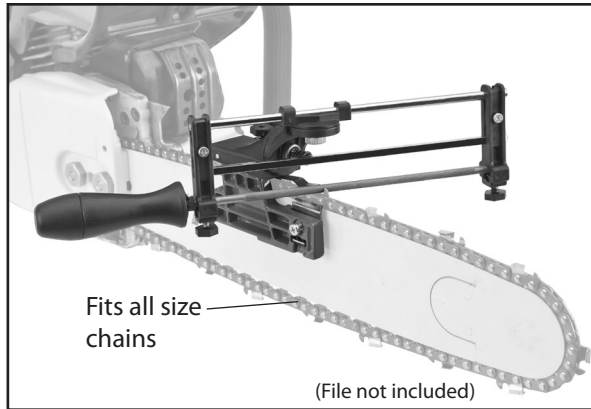

Fits all size chains

(File not included)

- For manual precision saw chain filing.
- All angles, depths and file heights are dial set. No guesswork.
- Locks in filing angle and depth setting to ensure consistent, correct filing.
- Accurately filed saw chain will help reduce fatigue... it makes the saw do the work, not you.
- Round file not included with guide. See the chart below for correct file size to use for your chain.
- Complete, easy-to-use instructions are included.

IF YOU HAVE THIS CODE CHAIN	RECOMMENDED FILING ANGLES	DEPTH GAUGE SETTING	FILE SIZE
S (91VG)	FILING DIRECTION 90° 30°	.025 DEPTH GAUGE SETTING	5/32"
H (33SL)	FILING DIRECTION 90° 25°	.025 DEPTH GAUGE SETTING	5/32"
D (72SG)	FILING DIRECTION 90° 30°	.030 DEPTH GAUGE SETTING	7/32"

Please Recycle This Package



WARNING

Always wear safety glasses when using this tool!

T10278
CHAIN SAW FILING GUIDE



* T 1 0 2 7 8 *

MADE IN CHINA
FOR GRIZZLY INDUSTRIAL, INC.

13109

Chain Saw Filing Guide

- For precision manual chain saw filing
- Locks in filing angle and depth control setting to ensure consistent and correct filing
- Includes easy-to-use instructions

Chain Sharpening Instructions

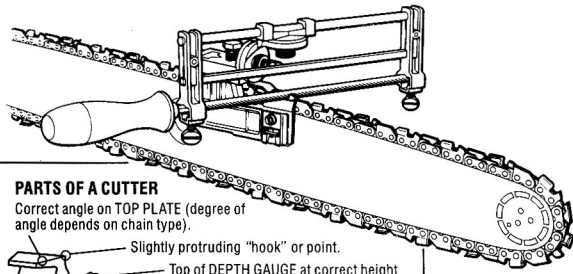

PARTS OF A CUTTER

Correct angle on TOP PLATE (degree of angle depends on chain type).

- Slightly protruding "hook" or point.
- Top of DEPTH GAUGE at correct height below TOP PLATE.
- Front of DEPTH GAUGE rounded off.

SAFETY INFORMATION!

- Always wear gloves.
- Always work on a clean, flat working surface.
- Make certain that file guide has been mounted securely to chainsaw guide bar before sharpening.
- Check components on file guide regularly for wear and general condition.

WARNING: Follow all instructions for cutter filing angles and depth gauge settings. Incorrect sharpening angles, excessive depth gauge settings or incorrectly shaped depth gauges may increase the risk of chainsaw kickback. Kickback can result in severe injury to the saw operator or to bystanders.

MOUNTING & SET-UP INSTRUCTIONS

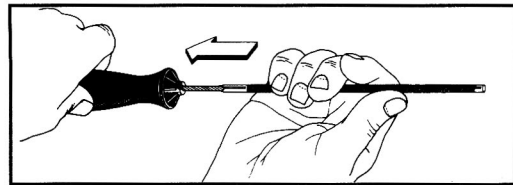

A. Select the proper file size for the chain to be sharpened. (See chart at right or chain manufacturer's instructions for correct file size.)

B. Push file handle (11) onto the file. Insert the file into the file holder (3) and tighten down both locking thumb screws (4).

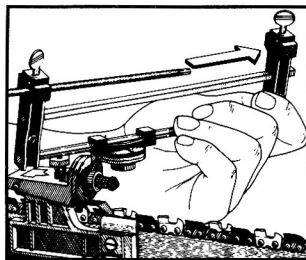

C. Mount file guide assembly on the guide bar so that the chain guide T-bars (5) are flush with the top of the chain rivets. Tighten assembly with locking thumb screw (8).

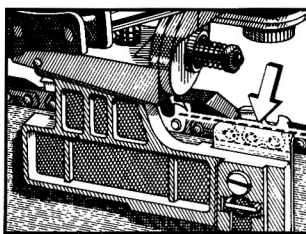

D. Position cutter against chain stop (7).

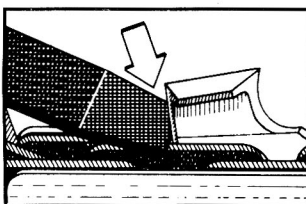

E. Secure the T-bars (5), by using thumb screw (6) and opposing slotted screw, to center the chain and stabilize cutter for sharpening.

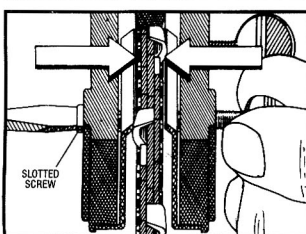

ASSEMBLY INSTRUCTIONS

File guide comes fully assembled, excluding file are not included. Purchase correct file file handle. (Round file and flat depth gauge size separately.)

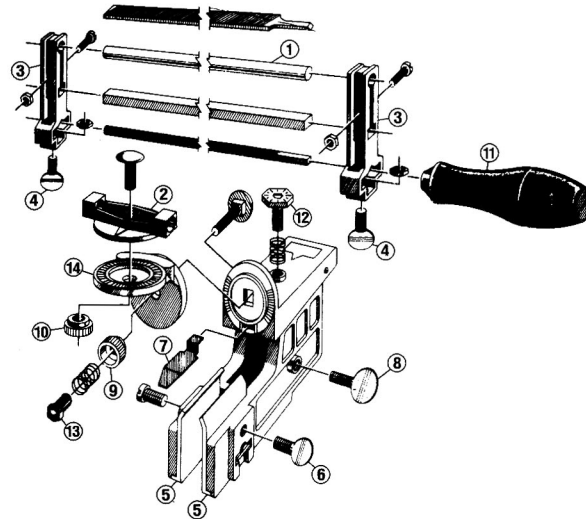

IF YOU HAVE THIS CODE CHAIN	RECOMMENDED FILING ANGLES	DEPTH GAUGE SETTING	FILE SIZE
S (91VG)	FILING DIRECTION 90° / 30°	.025 DEPTH GAUGE SETTING	5/32"
H (33SL)	FILING DIRECTION 90° / 25°	.025 DEPTH GAUGE SETTING	5/32"
D (72SG)	FILING DIRECTION 90° / 30°	.030 DEPTH GAUGE SETTING	7/32"

OPERATING INSTRUCTIONS

A. Set the tilt and swivel base (14) to either the 0° (for 90°) or 10° angle marks. See chain chart or chain manufacturer's instructions for correct degree mark.

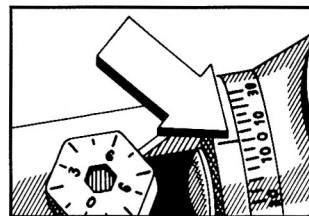

Lock into place using swivel knob (9).

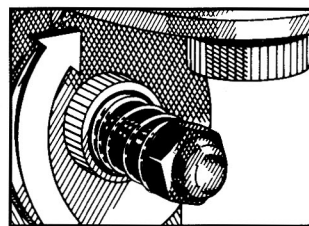

B. Set top swivel (2) to correct angle mark. See chain chart or chain manufacturer's instructions for correct degree mark.

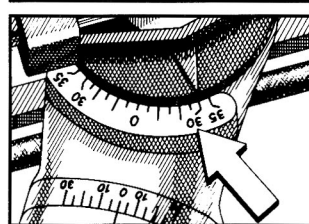

Lock into position with swivel knob (10).

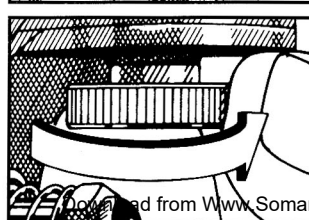

C. Insert file into the cutter, making sure file assembly is positioned at 90° to the T-bars (5).

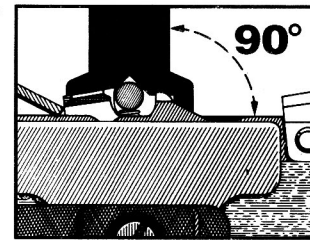

Place back of cutter against chain stop (7).

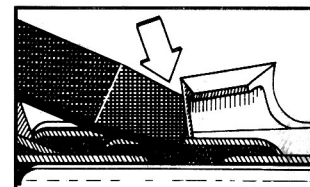

D. Set file height by turning the depth adjustment screw (12) so that 1/5th of file diameter is above the top plate of the cutter.

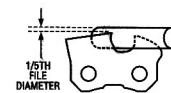

E. Adjust the stop screw (13) to control the amount of cutter to be filed.

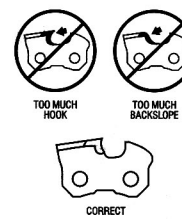

FILING

A. File all cutters from inside to the outside. File one side of the chain at a time.

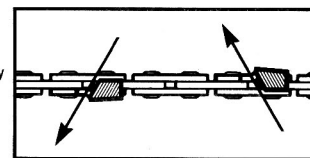

NOTE: File performance is greatly reduced if you file from the outside against the chrome plating.

B. To sharpen cutters on the opposite side of the chain, unlock swivel knob (10) and rotate swivel guide (2) to the similar setting on the opposite side.

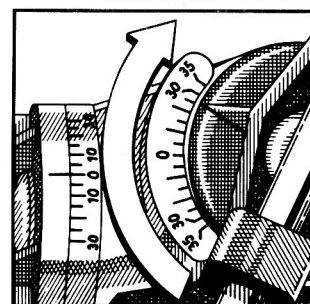

Reset angles shown in steps A-E of operating instructions - and repeat filing process.

HINT: Oil slide rod at guide swivel for better movement of guide assembly.

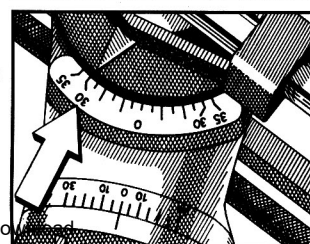

DEPTH GAUGE FILING

NOTE: Every 2 - to - 3 chain sharpenings it is necessary to file the depth gauges.

A. Remove round file and replace handle on flat file. Reinsert into file holder and secure.

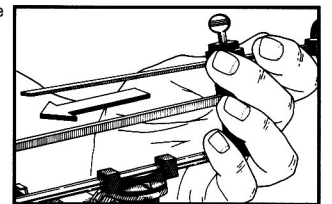

B. Set both filing angles to 0° so that the file is 90° to the guide bar.

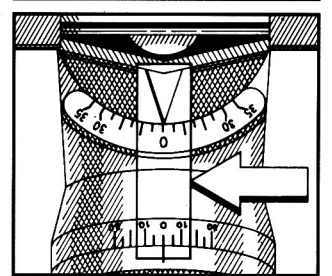
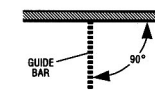

C. Turn adjusting screw (12) and lower file until it rests on the top plate of the cutter.

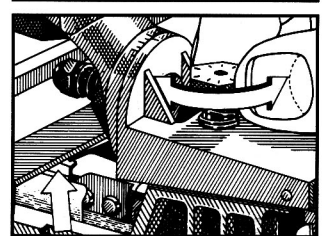

D. Move cutter backwards until file is directly above the depth gauge.

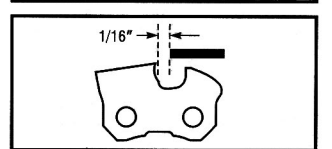

Position file approximately 1/16" (1.6mm) away from the cutting edge of the cutter so as to protect the edge from damage during this step.

E. Rest chain stop (7) on the top plate of the cutter during the filing operation.

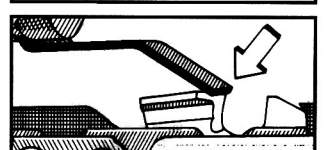

F. Rotate adjusting screw (12) counter-clockwise to the recommended depth-gauge setting (see chain chart or chain manufacturer's instructions for recommended setting).

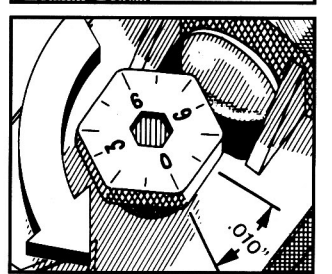

NOTE: Each increment mark on adjusting screw (12) equals .010" of file travel.

G. Always file depth gauges so filing stroke is from the inside of the cutter to the outside.

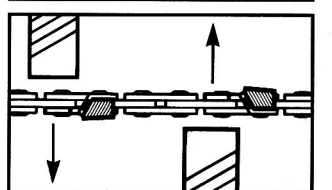

File all depth gauges on one side of the chain, then rotate swivel guide (2) 180°. Reset same angles for opposite side of chain and repeat filing process.

H. After each depth gauge has been filed to the recommended height, round off front corner to original shape.

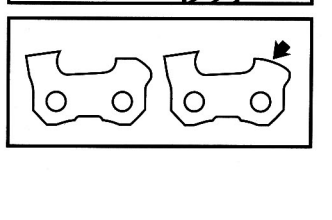

Free Manuals Download Website

<http://myh66.com>

<http://usermanuals.us>

<http://www.somanuals.com>

<http://www.4manuals.cc>

<http://www.manual-lib.com>

<http://www.404manual.com>

<http://www.luxmanual.com>

<http://aubethermostatmanual.com>

Golf course search by state

<http://golfingnear.com>

Email search by domain

<http://emailbydomain.com>

Auto manuals search

<http://auto.somanuals.com>

TV manuals search

<http://tv.somanuals.com>