

iHome

AIR SERIES



works with



iHome+apps
available on the App Store

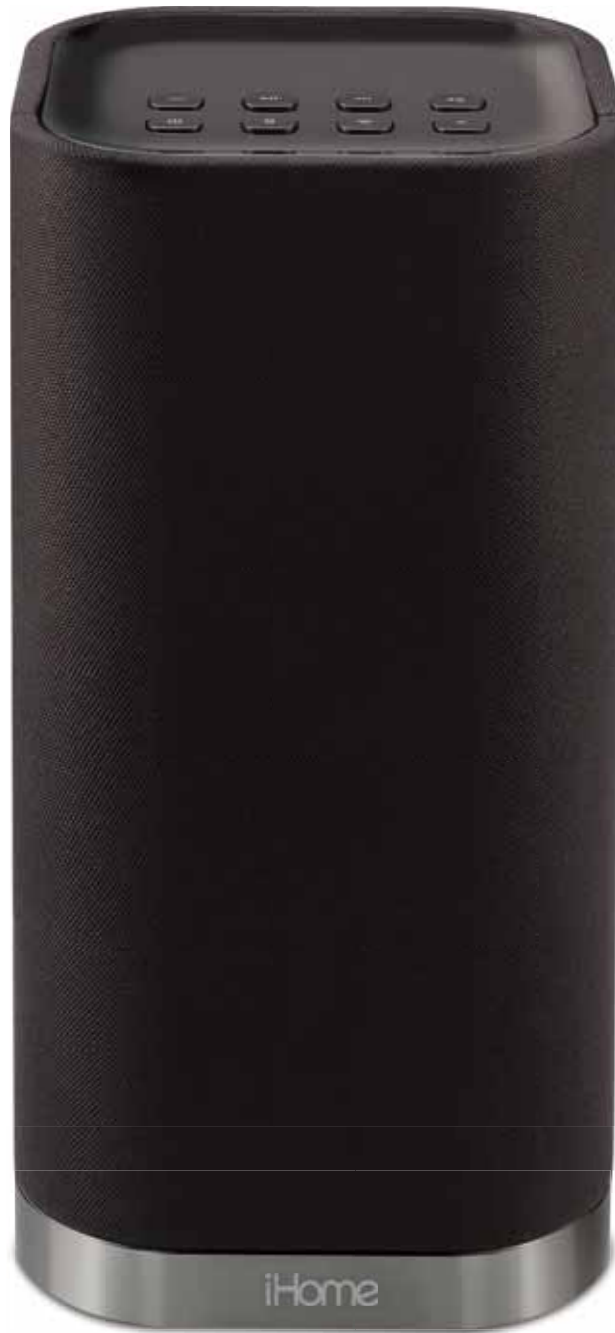

iW3 User Manual

AirPlay wireless speaker system with rechargeable battery



Welcome to the iHome iW3

Thank you for choosing iHome. The Air Series represents the new frontier of product offerings from iHome that embrace Wi-Fi connectivity and AirPlay, Apple's new wireless streaming technology.

The iHome iW3 with AirPlay offers the latest experience in home audio entertainment allowing users to stream digital audio over Wi-Fi from iTunes, iPad, iPhone and iPod touch. Featuring SRS® DSP technology and a built-in rechargeable lithium-ion battery, the iW3 offers high fidelity audio that is truly wireless.

You can use the iW3 to:

- Stream music directly from iTunes on your Mac or PC using your home Wi-Fi network
- Stream your favorite music from your iPad, iPhone, and iPod touch's iPod music library or popular music apps like PANDORA®, iHeartRadio®, and Tunein® available on the App Store
- Play and charge your iPad, iPhone, and iPod with included USB sync cable
- Enjoy true wireless audio anywhere around the house with the iW3's rechargeable battery, convenient charging base and integrated handle
- Add multiple iW3 speakers to enjoy multi-room audio anywhere in the home (*note: streaming to multiple speakers simultaneously requires iTunes as the source*)
- Download and enjoy iHome+ apps available on the App Store:
 - iHome Set, a free iHome utility app for easy network setup, device settings and firmware updates
 - iHome Sleep, a free music alarm clock app

Keep reading to discover everything you need to know to get the most from your iHome iW3.



iW3 Overview

Contents

1. iW3 speaker
2. iW3 start guide
3. Charging base
4. Power adaptor
5. USB sync cable



iW3 speaker



iW3 start guide

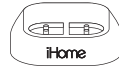

charging base



power adaptor



USB sync cable

Compatibility



USB connector works with:

iPod touch (2nd, 3rd, and 4th generation), iPod nano (2nd, 3rd, 4th, 5th, and 6th generation), iPhone 4S, iPhone 4, iPhone 3GS, and iPhone 3G, and iPad (1st, 2nd, and 3rd generation).



AirPlay works with:

iTunes, iPod touch (2nd, 3rd, and 4th generation), iPhone 4S, iPhone 4, iPhone 3GS, and iPad (1st, 2nd, and 3rd generation).

For AirPlay, the iW3 must be connected to Wi-Fi with networked access to a Mac or PC running iTunes 10.1 or later; or an iPad, iPhone, or iPod touch running iOS 4.2 or later.



iHome+apps:

iHome Sleep and iHome Set apps work only with iPad, iPhone, iPod touch and require iOS 4.2 or later

Maintenance

Place the unit on a level surface away from sources of direct sunlight or excessive heat.

Protect your furniture when placing your unit on a natural wood and lacquered finish. A cloth or other protective material should be placed between it and the furniture.

Clean your unit with a soft cloth moistened only with mild soap and water. Stronger cleaning agents, such as benzene thinner or similar materials can damage the surface of the unit.

iW3 Controls

TOP PANEL

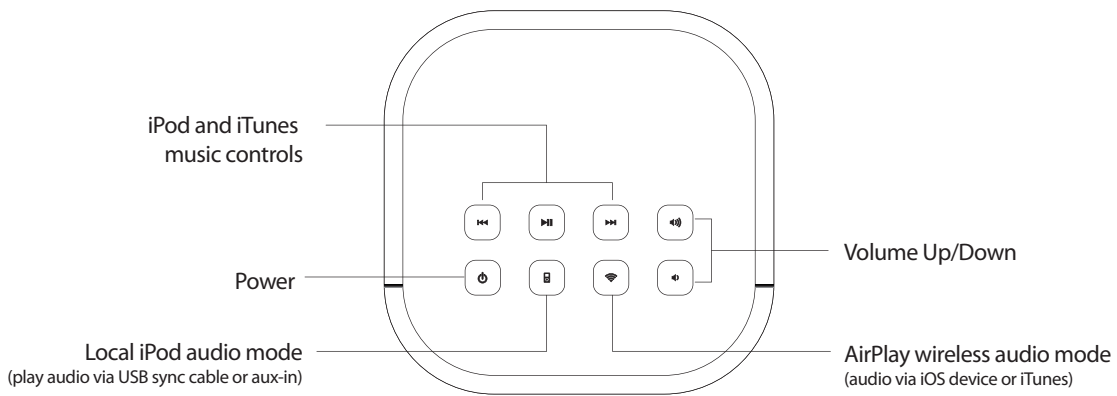

REAR PANEL

FRONT PANEL



Status LED

- OFF, when in Standby or Power OFF mode and battery is fully charged
- Green, solid when unit is ON
- ✱ Green, blinking when volume is muted
- Red, solid when battery is charging
- ✱ Red, blinking when battery needs charging

REAR PANEL

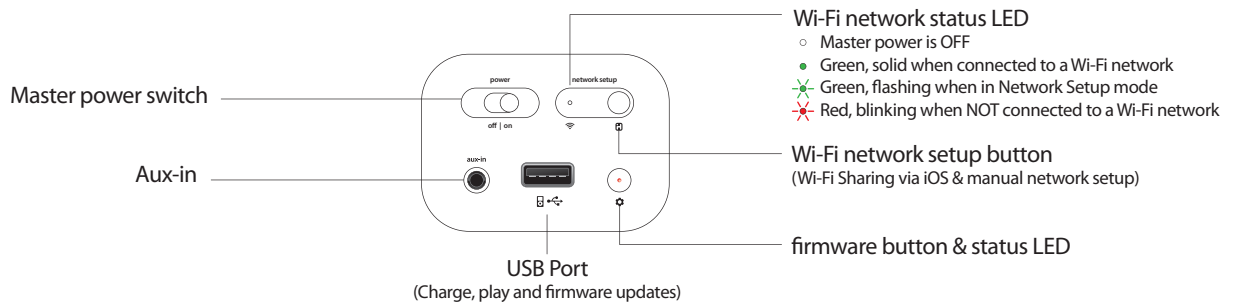

Quick Start

Power

- 1 Connect charging base to power source
- 2 Place iW3 on charging base
- 3 Turn master power switch ON
- 4 Press  power button

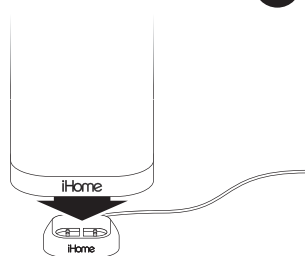
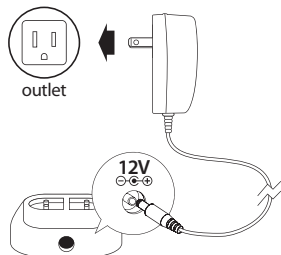

allow 30 seconds for the iW3 to startup pressing the power button will switch the iW3 from power ON and standby

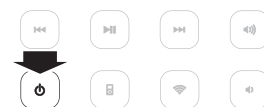

For best results, charge unit fully before use.

iPod Local Audio Mode

- 1 Connect iPad/iPhone/iPod using iPod USB sync cable and USB port (iPod and aux-in play in parallel)
- 2 Press  for iPod mode
- 3 In iPod mode, press    buttons on the iW3 to control your iPod music.

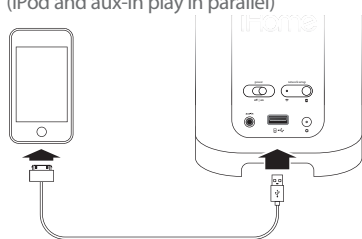

Press   buttons to adjust volume.

Note: Use iPod mode for audio playback via iPod with USB cable and Aux-in.

AirPlay Wireless Audio Mode (visit pages 8-9 for Wi-Fi network configuration)

- 1 Verify that your iW3 speaker is successfully connected to your Wi-Fi network. (visit page 8 for connecting your iW3 speaker to your Wi-Fi network)
- 2 Press  for AirPlay wireless mode
- 3 Launch iTunes or use your iPad, iPhone, iPad touch. Verify iW3 and AirPlay source device is on same Wi-Fi network.

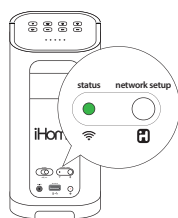

Connected

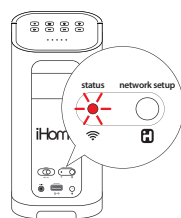

Not Connected

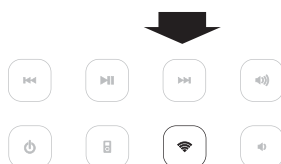

AirPlay only works with iPod touch, iPhone, iPad, or iTunes (Mac or PC)

- 4 Select the iHome iW3 as your AirPlay audio speaker
- 5 Press    buttons on the iW3 or use your iTunes, iPad, iPhone, or iPod touch controls directly.

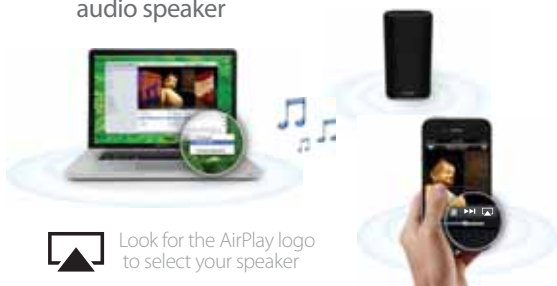

Look for the AirPlay logo to select your speaker

Adjust volume on the iW3 or wirelessly control volume on your AirPlay source device.

Press   buttons to adjust volume.

- !** *Note:* for AirPlay streaming:

iPad, iPhone, and iPod touch support point-to-point audio streaming to one AirPlay enabled speaker at a time.

iTunes supports point-to-multipoint audio streaming to up to three AirPlay enabled speakers (performance depends on both your Wi-Fi network and environment).

Getting Started

Master Power Switch

The iW3 has a master power switch that is used to power the unit ON or OFF, help conserve battery life, and reset the iW3 speaker. In order for the iW3 speaker to power ON, the battery must be charged or placed on the charging base connected to an AC outlet.

Master Power ON - Slide the **Master Power Switch** (on rear panel) to the ON position to activate your iW3 speaker.

Master Power OFF - Slide the **Master Power Switch** to the OFF position to power the iW3 speaker OFF.

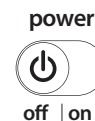

Note: If the iW3 is in the Master Power OFF state the iW3 will only allow charging of the iW3's internal battery and will not support iPod/iPhone charging, AirPlay, network setup, nor firmware updates.

Powering your iW3 speaker ON

To power the iW3 speaker ON:

1. Plug **AC adaptor** into **Charging Base**, and plug into a live AC wall outlet.
2. Place the **iW3 Speaker** on top of the **Charging Base**.
3. Slide the **Master Power Switch** (on rear panel) to the ON position.

Note: Allow 30 seconds for the speaker to startup before interacting with the iW3 speaker.

4. Press the **Power** button to switch between power ON and Standby mode.

The iW3 speaker will power ON to the previous mode (default is AirPlay mode).

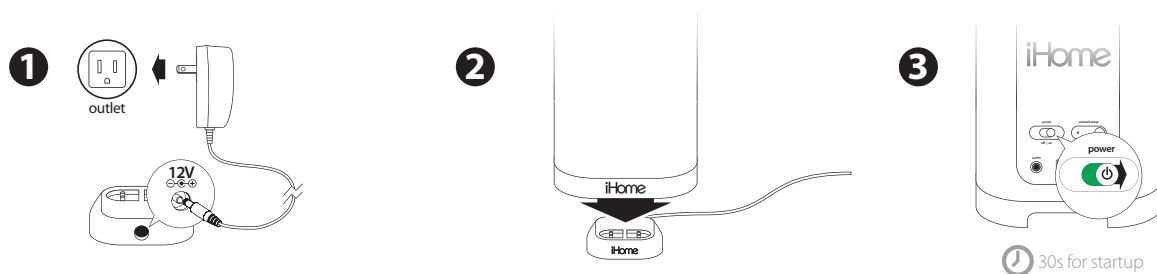

Rechargeable Battery

The iW3 speaker has an internal rechargeable battery and supports audio playback anywhere in the home when the battery is charged.

To Charge the Battery:

1. Plug **AC adaptor** into **Charging Base**, and plug into a live AC wall outlet.
2. Place **iW3 Speaker** on top of **Charging Base**.

Note: Allow up to 10 hours to fully charge the iW3's battery

Resetting your iW3 speaker

It is possible for the iW3 speaker to lockup and be unresponsive, making it necessary to reset the unit.

To reset the iW3 speaker:

1. Remove the **iW3 Speaker** from the **Charging Base**.
2. Using a paper clip, press the **Reset Button** on the bottom of cabinet within the charging base recess.

The iW3 will reboot and power ON again.

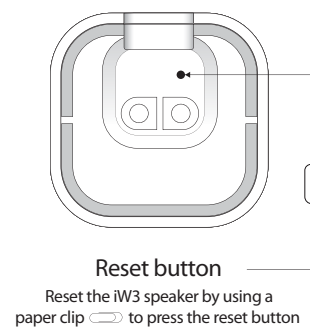

Using your iW3

Top panel controls

The iW3 speaker has a control interface for power, mode, volume, and music controls. Controls are lit according to the status of the iW3 speaker and the selected mode.

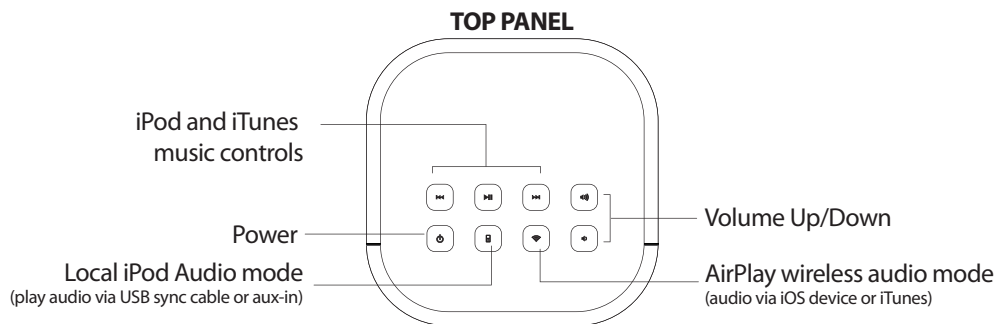

Standby mode

Standby Mode (master power switch is ON):



Press the **Power** button to place the iW3 speaker in standby mode and stop audio playback. The **Power** button will pulse on/off to indicate the iW3 is in standby mode.

Power ON modes

iPod Mode (iPad/iPhone/iPod detected via USB connector):



iPod Mode (iPad/iPhone/iPod not detected via USB connector):



AirPlay Wireless Mode (connected to a Wi-Fi network):



AirPlay Wireless Mode (not connected to a Wi-Fi network):



Note: The **AirPlay Wireless** button will continuously flash on/off to indicate that the iW3 is not linked to a network when ON and in AirPlay Wireless mode.

Volume

Press **Volume Up/Down** buttons to adjust volume.



Wi-Fi Network Setup for AirPlay

Check list

Please verify the following steps before attempting to connect your iW3 speaker to a Wi-Fi network:

- ✓ To enjoy AirPlay wireless audio, you must have the following:
 - iTunes or an iOS device (iPod touch, iPhone, or iPad).
 - A functioning home network with Wi-Fi.
- ✓ Download the latest software updates for iTunes and your iOS device to ensure that you are able to enjoy the latest AirPlay enhancements and compatibility.
- ✓ Download the  **iHome Set** app for iPod touch, iPhone and iPad.
- ✓ Have your Wi-Fi network name (SSID) and password (if applicable) available for reference.

Note: AirPlay requires iTunes 10.1 (Mac and PC) or later; OR an iPad (3rd, 2nd, and 1st generations), iPhone 4S, iPhone 4, iPhone 3GS, iPod touch (4th, 3rd, and 2nd generations) with iOS 4.2 or later. The iHome Set app requires iOS 4.0 or later.

Option A - Connecting via Wi-Fi sharing for iPod Touch, iPhone, or iPad (Recommended)

If you have an iPod touch, iPhone, or iPad with iOS 5.0 or later, we recommend that you use Wi-Fi sharing for the quickest network setup experience.

To connect your iW3 speaker to a Wi-Fi network using Wi-Fi sharing, follow these steps:

1. Activate Wi-Fi on your iPad/iPhone/iPod touch (with iOS 5.0 or later) and ensure you are connected to the network whose settings you wish to share network settings with the iW3 speaker.
2. Connect your iOS device to the iW3 using the included iPod **USB sync cable**.
3. Press the  Network Setup button on the back of the iW3.
4. A pop-up message will appear on the iOS device asking if you want to share your Wi-Fi settings. Select 'Allow'.

The iOS will share current wireless network credentials with the iW3 and a confirmation tone will sound.

Success!

Congratulations, you have successfully connected your iW3 to your wireless network and now you can start enjoying wireless audio anywhere in your home or office. Verify that the Network Status LED is green and then keep reading to learn how to use iW3 to stream your iTunes and iOS audio content using AirPlay.

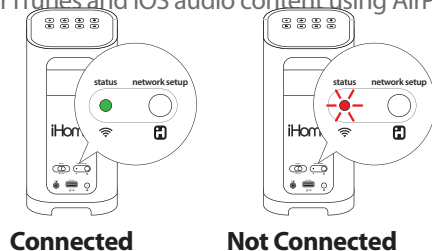

2

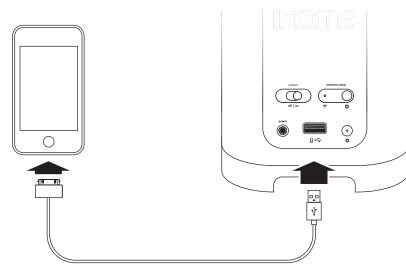

3

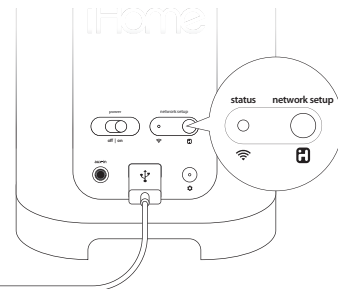

4

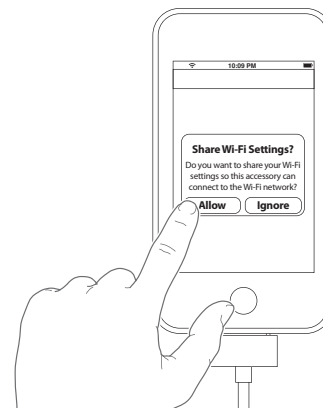

Problem?

Reset the iW3 Speaker:

- Unplug the AC cable/remove the iW3 from the charging base
- Slide the rear Power Switch to the OFF and then ON position
- Reconnect AC cable, place iW3 on charging base and wait 30 seconds
- Repeat iW3 Wi-Fi Network Setup process if necessary
- See *Troubleshooting* on page 12-13 for other tips.



Note: Your AirPlay source devices (Mac or PC with your iTunes library as well as your iPod touch, iPhone or iPad) must be connected to the same Wi-Fi network as the iW3 speaker is connected to before using AirPlay wireless streaming.

Wi-Fi Network Setup continued...

Option B - Manually connecting & managing settings with the iHome Set app

If you have an iPod touch, iPhone, or iPad with iOS 4.0 or later, we recommend that you use our free iHome Set app to easily rename your iW3 speaker and configure network settings.

To connect your iW3 speaker to a Wi-Fi network using iHome Set, follow these steps:

1. Connect AC power and power ON the iW3 speaker.
2. Connect your iOS device to the iW3 using the included iPod USB sync cable.
3. Download our free  **iHome Set** app from the  App Store and launch the app.
4. Scroll down the app interface and select the 'Network' tab interface and then select 'Manual Setup' button.
5. Select your preferred Wi-Fi network from the list of available networks and enter password if prompted. Select 'Other Network' to connect to network with a hidden SSID.

Note: Connecting to a network may take up to 120 seconds. If network connection is unsuccessful, reset the unit or disconnect your iOS device and reconnect and repeat the above steps.

6. OPTIONAL: To rename your iW3 speaker, exit manual network setup, select 'Speaker Name' and customize how your iW3 speaker will present itself on your network. Press 'DONE' to confirm the new name.

Success!

Congratulations, you have successfully connected your iW3 to your wireless network and now you can start enjoying wireless audio anywhere in your home or office. Verify that the Network Status LED is green and then keep reading to learn how to use iW3 to stream your iTunes and iOS audio content using AirPlay.

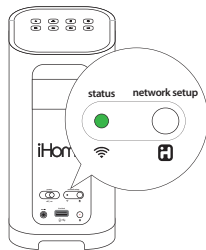

Connected

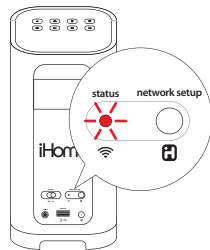

Not Connected

Note: Your AirPlay source devices (Mac or PC with your iTunes library as well as your iPod touch, iPhone or iPad) must be connected to the same Wi-Fi network that the iW3 speaker is connected before using AirPlay wireless streaming.

1



2

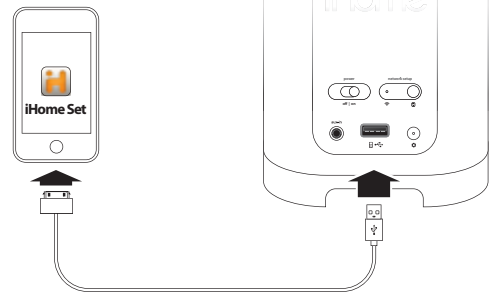

4

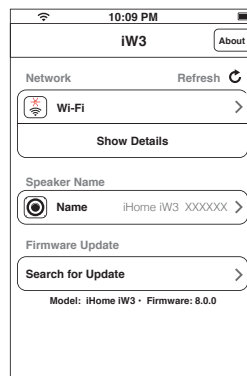

5

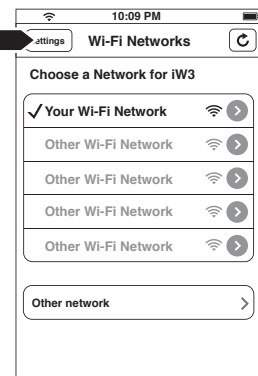
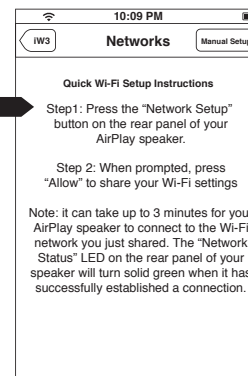

 30s
Choose your Wi-Fi network from the available networks and wait as the iW3 attempts to connect.

6

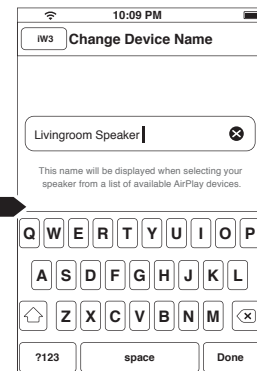
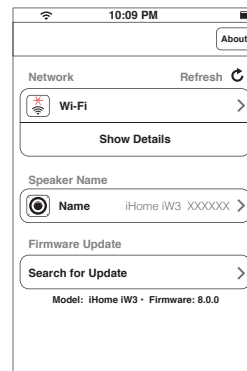

Problem?

Reset the iW3 Speaker:

- Unplug the AC cable/remove the iW3 from the charging base
- Slide the rear Power Switch to the OFF and then ON position
- Reconnect AC cable, place iW3 on charging base and wait 30 seconds
- Repeat iW3 Wi-Fi Network Setup process if necessary
- See *Troubleshooting* on page 12-13 for other tips.

Wi-Fi Network Setup continued...

Option C - Connecting with your Mac or PC over Wi-Fi

To connect your iW3 speaker to a Wi-Fi network using a Mac or PC, follow these steps:

1. Connect AC power and power ON the iW3 speaker.
2. Press and hold (5 sec.)  Network Setup button on the back of unit.

Note: The Network Status LED will begin flashing green and the top control panel will also flash.

3. On your Mac or PC, select the network called "iHome Setup #####" from Wi-Fi network settings.

Note: This process can take up to 2 minutes. Be patient and refresh your network list if necessary.

4. Launch a web browser (ex. Safari, Chrome, or Firefox) and enter **http://192.168.1.12** in the address bar.

Note: If the page is not initially available or becomes unresponsive, reload the page. See "troubleshooting" if problem persists.

5. Rename the iW3 speaker and click 'Apply'. (optional)
6. Select the 'Networking Tab', click 'Configure Network Settings', choose preferred Wi-Fi network from the list of available and click 'Apply'.

Note: Connecting to a network may take up to 120 seconds. If network connection is unsuccessful reset the iW3 by powering OFF/ON again and then repeat the above steps.

Success!

1. Verify that the Network Status LED is green to confirm if the iW3 is successfully connected to a network.
2. Disconnect from "iHome Setup #####" and connect your Mac/PC to the same network you connected the iW3 speaker.
3. Keep reading to learn how to use the iW3 to stream and control your iTunes and iOS audio content.

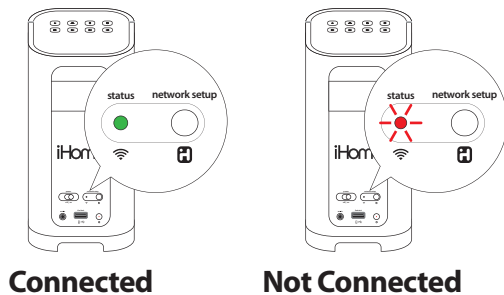

Note: Your AirPlay source devices (Mac or PC with your iTunes library as well as your iPod touch, iPhone or iPad) must be connected to the same Wi-Fi network that the iW3 speaker is connected before using AirPlay wireless streaming.

1

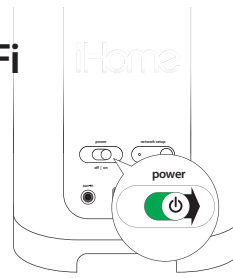

2

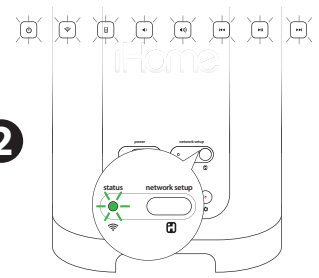

3

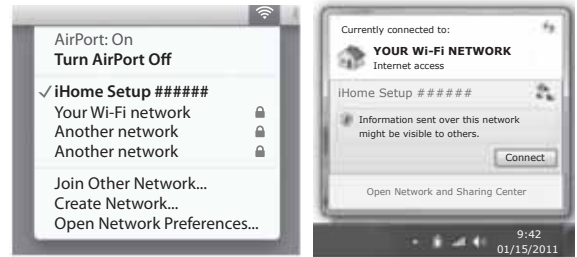

 upper right corner of Mac screen

 lower right corner of PC Screen

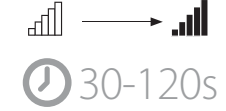

4

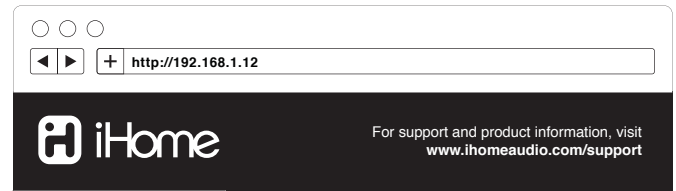

5

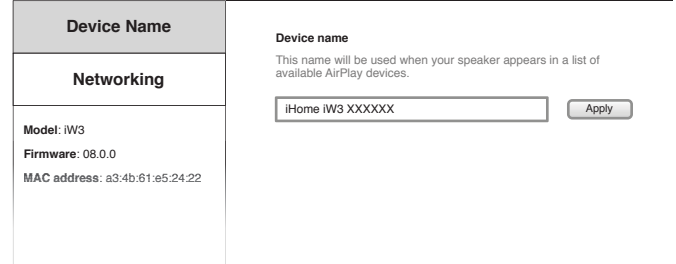

6

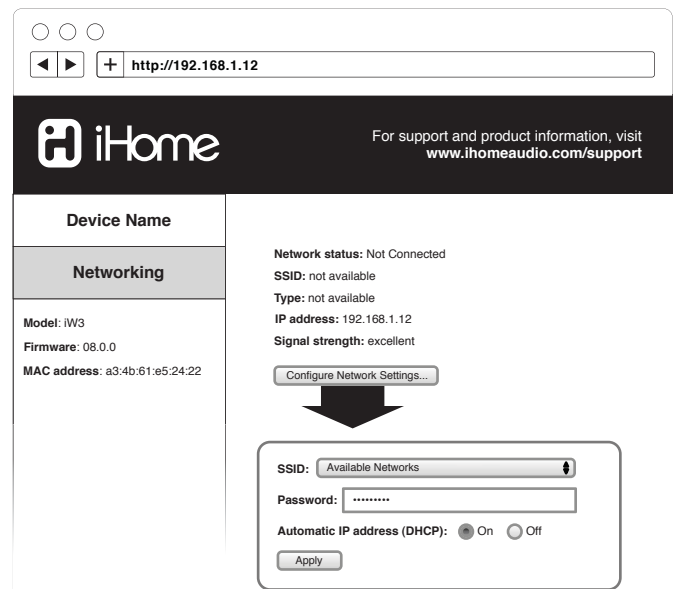

Music Connectivity





Connecting to the iW3 speaker

You can connect to your iHome iW3 speaker three different ways:

1. Using AirPlay® to stream wirelessly from iTunes or your iPad, iPhone, and iPod touch.
2. Using the USB port on the rear panel with a iPod USB sync cable for audio and charging your iPod or iPhone.
3. Using an auxiliary audio device (mp3 or CD player) connected to the aux-in port on the rear panel.



AirPlay & iPod touch, iPhone, or iPad

Using an iOS device:

1. Connect your iOS device to the same Wi-Fi network as iW3. Go to  Settings -->  Wi-Fi on your iOS device.
2. Tap on  iPod/Music app, look for the  AirPlay button next to the iPod music transport controls.
3. Tap on the  AirPlay icon and choose iW3 from the list of speakers. If the iW3 speaker is not available, restart your iOS device and verify that the iW3 is powered on and connected to the same Wi-Fi network.
4. Press play.





AirPlay & iTunes

Using a Mac or PC with iTunes:

1. Connect your Mac or PC to the same Wi-Fi network as iW3.
2. Open  iTunes on your computer.
3. Within iTunes open "Preferences", Select the "Devices" tab, and activate the following option: "Allow iTunes control from remote speakers"
4. Click OK, close iTunes preferences.
5. Look for the  AirPlay icon in the bottom right corner of the iTunes window.
6. Click the  AirPlay icon and choose iW3 from the list of speakers. Click "Multiple Speakers..." to select additional AirPlay speakers. If the iW3 speaker is not available, restart iTunes and verify that the iW3 is powered on and connected to the same Wi-Fi network.
7. Press play.





AirPlay Wireless Audio Mode

Enjoy AirPlay audio anywhere:

1. Press  to exit standby mode and power the iW3 ON.
2. Press  for wireless audio mode and to listen to AirPlay music.
3. Use the    buttons on the iW3 to control streaming AirPlay content.

Local iPod Audio Mode

Charge and Play using iPod USB sync cable:

1. Connect USB sync cable to iW3's USB port.
2. Press  Local Playback mode button and enjoy iPod and iPhone charging and audio playback.
3. Use the    buttons on the iW3 in iPod mode to control your music.

Note: Use Local Audio mode for both iPod and Aux-in audio playback.

Control

SRS TruBass

The iW3 features SRS TruBass® digital sound processing to enhance the audio performance and ensure proper bass response when listening to your music. The SRS TruBass function is on by default and can only be turned off using the iHome Set app.

EQ

The iW3 has an EQ feature that is controlled using the iHome Set app to adjust Bass and Treble.

TREBLE +/- buttons: Adjust treble levels between -5 and +5. Default is 0



BASS +/- buttons: Adjust bass levels between -5 and +5. Default is 0

Firmware update

It may be necessary to update the firmware of your iW3 speaker to ensure the latest compatibility and optimal functionality. The iW3 offers three different methods for performing the firmware upgrade, detailed below as Option A, B and C. You only need to choose one.

Note: If you have access to an iOS device running 4.2 or later we recommend option A.

Option A - Firmware update using iHome Set

1. Power ON the iW3 speaker and place on the charging base.
2. Connect your iOS device to the iW3 using the included iPod **USB sync cable**.
3. Download our free  **iHome Set** app from the  App Store and launch the app.
4. Scroll down the app interface and select 'Search for Update'.
5. If there is an update available, a message will pop-up asking if you would like to apply the firmware upgrade.
6. Select 'Upgrade'.

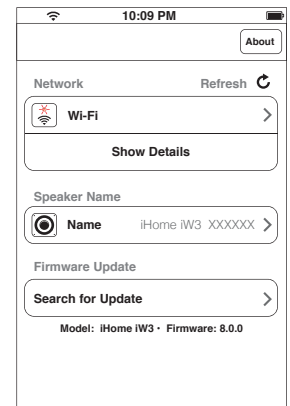

Option B - Firmware update using USB mass storage device

1. Using your computer visit www.ihomeaudio.com/support/product/iW3 and download the latest firmware from the top right corner of the support page. Please be sure to remember the location where you save the file to on your computer.
2. Locate the file from step 1 and load the file onto a USB mass storage device
Note: You must load it to the root (main) directory. Do not create a separate folder within the USB device.
3. Power on your iW3. When the iW3 is fully powered on connect the USB drive to the port located on the rear panel.
4. Press and Hold the  Firmware button for 5 seconds.

Note: The update process will take around 3 minutes to complete.

During Firmware Update:

There are two indicators on the iW3 to track the progress of the update:

1. The firmware update LED will remain RED
2. The top panel LED's will light up in succession to note the progress of the update (see diagram below)

Note: If the Firmware LED remains unlit this indicates that the process was unable to begin. Please be sure the proper file was loaded on the USB drive and start over from step 3 above.

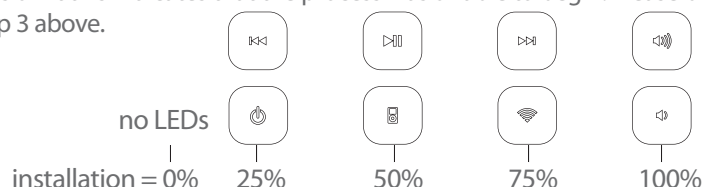

Firmware update continued...

Option C - Firmware update using Mac/PC

Follow these steps to update the firmware of your iW3 speaker using only your Mac or PC. Please note that we recommend trying option A or B before attempting this method.

1. Using your computer visit: www.ihomeaudio.com/support/product/iW3 and download the latest firmware from the top right corner of the support page. Please be sure to remember the location where you save the file to on your computer.
2. Verify that your iW3 is successfully connected to your home network.
3. Open a web browser (we recommend Safari) and access the iHome Device Management webpage by using Bonjour services or directly typing in the iW3's IP address. The IP address can be found using iHome Set under network details or by re-initiating the network setup mode on page 10.

Note: Make sure that you have enabled Bonjour service in your PC. Take Windows XP for example: to enable the service, you can click Start->Settings->Control Panel, and double click Administrative Tools->Services->Bonjour Service, then click Start followed by OK on the pop-up menu.

4. If everything was done correctly you'll see the page pictured.
5. Click the "Firmware" tab on the left column and follow the on-screen instructions.

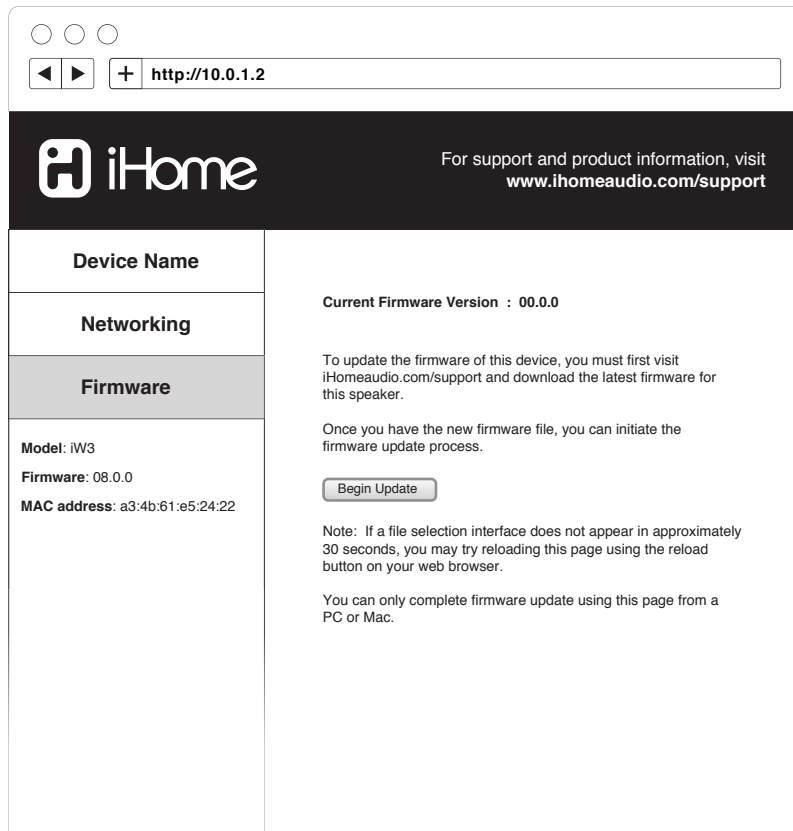

During Firmware Update:

1. The top panel LED's will light up in succession to note the progress of the update (see diagram below)
2. The iW3's device management web page will indicate progress.

The iW3 will restart if firmware update is successful.

Note: This process can take 4-5 minutes.

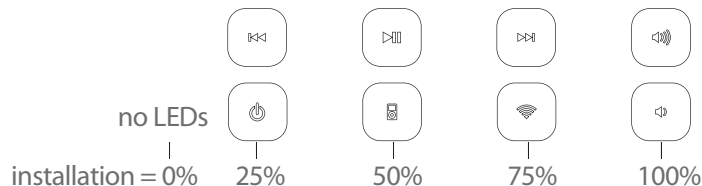

Troubleshooting

Quick tips for common problems:

I am unable to connect the iW3 to my home Wi-Fi network:

- The iW3 does not support WEP or WPA/WPA2 Enterprise security types. We recommend Open, WPA Personal (-PSK), WPA2 Personal (-PSK). Once you change the security type on your router, we suggest rebooting your Wi-Fi router and your iW3 speaker.
- Make sure router firmware is up to date.
- Make sure that your wireless network is not on a conflicting channel with one of your neighbors. You can use software like iStumbler on Mac or Netstumbler on Windows to verify that adjacent networks, sorted by SNR, aren't on the same channel. Channels 1, 6, and 11 are the three non-overlapping 802.11g channels.
- If you cannot see your network on the list of available networks, ensure that your network is not hidden. If so unhide and reboot the router.

I cannot find the MAC address of my iW3 speaker:

- Use the iHome Set app with the iPad/iPhone/iPod touch, connected with the USB sync cable and select 'Show Details' under the NETWORK tab (*note*: you can also discover the MAC address using the manual network setup method - see page 10).

I've successfully connected the iW3 to my home network, but I cannot select the iW3 speaker from iTunes or my iOS Device:

Note: The iW3 speaker must be on the same Wi-Fi network as your airplay source

iTunes Solutions:

- Make sure that you have the latest version of iTunes.
- Try restarting iTunes.
- In order for the iW3 to be able to access track controls in iTunes you need to allow it in iTunes:
 - In iTunes, go to Preferences.
 - In the Devices tab, check "Allow iTunes audio control from remote speaker"

iOS device solutions:

- Make sure the iOS device has the latest software.
- If you're unable to see the Airplay icon on the iOS device, restart your iOS device;
- Verify that your device is connected to the correct Wi-Fi network.

I've selected the iW3 speaker as my AirPlay audio source, but I do not hear any music:

- Verify that the volume is not muted or set to 0.
- Verify that there is not another iTunes library or iOS device connected to the iW3 speaker.
- Try restarting iTunes or your iOS device.
- Reset the iW3 speaker and reboot your Wi-Fi router.

The iW3 doesn't respond or doesn't turn ON:

- Place the iW3 on the charging base and fully charge your speaker.

USB Cable issue: Error message "this device is not supported":

- Please restart your iW3 speaker as well as your iOS device and then try again.

Quick tips for network setup via Mac/PC:

I cannot access http://192.168.1.12 webpage:

- Please make sure that your Mac/PC is connected to the 'iHome Setup XXXXXX' network on your list of available networks (*note*: internet access is not needed for this)
- Disable any firewalls that may prevent you from accessing this address: (i.e. anti-virus protection)
- Restart your browser.

I put my password in and hit "Join Network" and the network status is still blinking red:

- Please verify that you have entered the correct password for your wireless network.
- Restart the iW3 speaker.

AirPlay & Network Setup

Problems	Possible Solutions
<p>I am unable to connect the iW3 to my home Wi-Fi network.</p>	<ol style="list-style-type: none"> 1. Verify that your Wi-Fi network is functioning and Wi-Fi certified. This device is only compatible with Wi-Fi certified routers. 2. Move the iW3 closer to your network access point; the Wi-Fi signal is weak or there are overlapping Wi-Fi signals or the iW3 is out of range of your Wi-Fi network. 3. Make sure that your wireless network is not on a conflicting channel with one of your neighbors. You can use software like iStumbler on Mac or Netstumbler on Windows to verify that adjacent networks, sorted by SNR, aren't on the same channel. Channels 1, 6, and 11 are the three non-overlapping 802.11g channels. 4. Use a WPA or WPA2 Personal key for security. We do not recommend the use of any WEP key for security and WPA/WPA2 enterprise is not compatible with AirPlay. 5. Keep away from potential sources of interference which may affect Wi-Fi signal, such as microwave ovens. 6. Make sure that the SSID name of your home router consists of normal characters or digits, with no space or special characters like %/#/* inserted. 7. If you choose to rename the AirPlay device 'iHome iW3 XXXXXX' in the settings menu, do not use special characters or symbols. 8. Reset the iW3 Hardware and repeat network setup: <ul style="list-style-type: none"> - Using a paper clip, reset the iW3 speaker by pressing the Reset Button on the bottom of the speaker within the charging base recess. The iW3 will reboot and power ON again. - Repeat iW3 Wi-Fi Network Setup process if necessary. 9. If the problem remains, it is strongly recommended to use our free iHome Set app for your iPod Touch/iPhone/iPad to do the first time Wi-Fi setup as some PC settings may affect the Wi-Fi network setup.
<p>I've successfully connected the iW3 to my home network, but I cannot select the iW3 speaker from iTunes or from my iOS device.</p>	<ol style="list-style-type: none"> 1. The iW3 speaker must be on the same network as your AirPlay source. 2. Verify you have the latest version of iTunes and/or iOS. 3. Disable the firewall software and security software, which may block ports that AirPlay uses to stream content. 4. Try restarting iTunes, your iOS device, and your router. <p>Note: The original iPhone, iPhone 3G, and iPod touch (1st gen) do not support AirPlay.</p>
<p>No AirPlay icon in iTunes or on my iPad/iPhone/iPod touch</p>	<ol style="list-style-type: none"> 1. Make sure that the device has already joined the AirPlay network. 2. Before you open iTunes, make sure that you have enabled Bonjour service in your PC. Take Windows XP for example: to enable the service, you can click Start->Settings-> Control Panel, and double click Administrative Tools-> Services->Bonjour Service, then click Start followed by OK on the pop-up menu. 3. Within iTunes open "Preferences", select the "Devices" tab, and activate the option that says "Allow iTunes control from remote speakers." 4. Try restarting iTunes, your iOS device, and your router. <p>Note: The original iPhone, iPhone 3G, and iPod touch (1st gen) do not support AirPlay.</p>

Questions? Visit www.ihomeaudio.com/support/airplay/

Problems	Possible Solutions
<p>I've selected the iW3 speaker as my AirPlay audio source, but I do not hear any music.</p>	<ol style="list-style-type: none"> 1. Verify that the volume is not muted or set to 0. 2. Verify that there is not another iTunes library or iOS device connected to the iW3 speaker. 3. Try restarting iTunes or your iOS device. 4. Try restarting your iW3: <ul style="list-style-type: none"> - Unplug the AC cable/remove the iW3 from the charging base. - Slide the rear Power Switch to the OFF and then ON position. 5. Upgrade the software on your AirPlay compatible device (iTunes, iPad, iPhone, or iPod touch).
<p>Occasional breaking of AirPlay music streaming.</p>	<p>Do one or all of the following:</p> <ol style="list-style-type: none"> 1. Enable the Auto Channel Scan option (if available on the Wi-Fi router). 2. Enable the Wireless Intelligent Stream Handling (WISH) option (if available on the Wi-Fi router). 3. Enable the Quality of Service (QoS) option (if available on the Wi-Fi router). 4. Move your iW3 speaker closer to your Wi-Fi access point. 5. Change network security settings to WPA (WPA2) Personal. WEP is known to cause issue with AirPlay streaming and we do not recommend this legacy security format. 6. Restart your iPod Touch/iPhone/iPad or iTunes or iW3 speaker. 7. Browsing Internet content like news, music, video, etc. via your home Wi-Fi network from other Wi-Fi devices may affect the AirPlay performance. In case of AirPlay break or disconnection, it is recommended to stop or limit Internet surfing.
<p>Problems using the iHome Set app.</p>	<p>Sometimes there is an authentication error with an iOS device (common to any iOS accessory) that causes the device running the iHome Set app to be unable to detect the iW3. The user may correctly connect the iW3 with the USB sync cable, but the app will keep showing the message "Please connect your iHome AirPlay compatible device with an iPod USB sync cable".</p> <ol style="list-style-type: none"> 1. Verify sync cable is connected to the rear USB port on the iW3 and securely connected to your iOS device (iPad, iPhone, iPod touch) 2. Restart iHome Set app (takes 10 sec.) <ul style="list-style-type: none"> - Exit app and double tap home button - Press & hold iHome Set app - Close app and exit app manager - Restart iHome Set 3. Restart iOS device (takes 1 minute) 4. Reset the iW3 speaker (takes 30 seconds) <ul style="list-style-type: none"> - Using a paper clip, reset the iW3 speaker by pressing the Reset Button on the bottom of the speaker within the charging base recess. The iW3 will reboot and power ON again. - Repeat iW3 Wi-Fi Network Setup process if necessary. <p><i>Note: iHome Set only works when docked with iHome AirPlay products and requires iOS 4.0 to work.</i></p>

Questions? Visit www.ihomeaudio.com/support/airplay/

General

Problems	Possible Solutions
The iW3 doesn't respond or doesn't turn ON.	<ol style="list-style-type: none"> 1. Verify that the adaptor is connected and the power outlet is always 'live' (not controlled by a wall switch). 2. Reset the iW3 Speaker: <ul style="list-style-type: none"> - Using a paper clip, reset the iW3 speaker by pressing the Reset Button on the bottom of the speaker within the charging base recess. The iW3 will reboot and power ON again. - Repeat iW3 Wi-Fi Network Setup process if necessary.
No sound.	<ol style="list-style-type: none"> 1. Verify that the volume is not muted or set to 0. 2. Verify the mode (AirPlay Wireless or iPod mode). 3. Verify iPod or iPhone is properly connected with the USB sync cable and connected to the iW3's USB port. 4. Verify that there is not another iTunes library or iOS device connected to the iW3 speaker. 5. Check the network connection. Set up the network again if needed. 6. Try restarting iTunes or your iOS device.
iPad/iPhone/iPod doesn't charge or play audio in iPod mode.	<ol style="list-style-type: none"> 1. iPad/iPhone/iPod is not docked properly – Disconnect your iPad/iPhone/iPod from the USB sync cable and check for obstruction on the connectors in the USB sync cable, on your iPad/iPhone/iPod, or USB port on the iW3. 2. Reset your iPhone/iPod - Please see the user manual or the Apple web site for details. Typically, holding the sleep button and the home button on a newer iPad, iPhone or iPod will reset it. 3. Upgrade the software on your iPad, iPhone or iPod to the latest version by connecting it to a computer with iTunes installed and checking through iTunes that your unit has the most recent software. Update if needed. 4. Verify that the iW3 is compatible with your iPad, iPhone or iPod: iPod touch (2nd, 3rd, and 4th generation), iPod nano (2nd, 3rd, 4th, 5th, and 6th generation), iPhone 4S, iPhone 4, iPhone 3GS, iPhone 3G, iPad, iPad 2, and iPad 3rd generation.
Sound crackles, is distorted, has a loud hum or buzzing.	<ol style="list-style-type: none"> 1. Turn the iPod device or other source component's volume down. 2. Make sure that the iPod's device EQ setting is set to "OFF" 3. Make sure that the USB sync cable is plugged all the way into your iPad, iPhone, or iPod and connected all the way to the iW3's USB port. 4. Make sure that the audio cable is plugged all the way into the iW3's Aux Input jack. Replace the aux-in cable or iPod sync cable. 5. Unplug the power supply and connect it to a different AC outlet. 6. Move unit away from potential sources of interference, such as microwave ovens, fluorescent lights, etc.

Questions? Visit www.ihomeaudio.com/support/airplay/

FAQ's

What is AirPlay?

AirPlay is a wireless audio and video platform designed by Apple to stream digital media over a home network (Wi-Fi or Ethernet). AirPlay is built-in to iTunes and the iPad, iPhone, and iPod touch running the latest software. For AirPlay enabled speakers, this means:

1. Consumers can stream their iTunes music to our iW3 AirPlay enabled speaker, their Apple TV, or other AirPlay enabled speakers.
2. iPad/iPhone/iPod touch owners can stream their iPod music AND audio content from other music apps like Pandora and iHeartRadio to our iW3 AirPlay enabled speaker, their Apple TV, or other AirPlay enabled speakers.
3. iTunes is unique because a user can stream whatever is playing in iTunes to multiple speakers around the house.
4. iOS devices (iPad/iPhone/iPod touch) can only stream to one AirPlay enabled device at a time.

What other equipment do I require to use iW3 with AirPlay?

Using the iHome iW3 with AirPlay requires a Mac or PC running iTunes (10.1 or later), or an Apple iOS device running iOS (4.2 or later) connected to the same network. Typically, a network will consist of a Wi-Fi router or hub.

What devices are compatible with AirPlay?

AirPlay works with iPod touch (2nd, 3rd, and 4th generation), iPhone 4, iPhone 3GS, iPad 3rd gen, iPad 2, iPad with iOS 4.2 and iTunes 10.1 (Mac or PC) or later.

What Apple devices are compatible with iW3's USB connector?

iW3 supports USB docking for iPhone and iPod for audio and charging with included USB sync cable. The USB connector works with iPod touch (1st, 2nd, 3rd, and 4th generation), iPod nano (2nd, 3rd, 4th, 5th, and 6th generation), iPhone 4S, iPhone 4, iPhone 3GS, iPhone 3G, iPad 3rd generation, iPad 2, and iPad.

Can I stream audio wirelessly to the iW3 without a network connection?

No, the iW3 and AirPlay audio source must be connected to the same Wi-Fi network via a router or hub.

Can I stream video wirelessly to iW3?

No, only audio streaming is supported.

Does the iW3 have an AUX-input for my TV or other audio device?

Yes, the iW3 can be used as a speaker system with many products that have headphone, stereo RCA or audio outputs (cable not included).

How many iHome iW3 units can I stream to at once?

This will depend on your network equipment capabilities and set-up. For Mac/PC with iTunes with a high performance network, up to three iHome iW3's may be used. An iPad, iPhone, or iPod touch can only stream to a single iW3 speaker.

What Wi-Fi technologies does iW3 support?

The iW3 is Wi-Fi certified to work with networks that use the 802.11b/g wireless standards.

What network security types does the iW3 support?

The iW3 supports the following security types: Open, WPA Personal (-PSK), WPA2 Personal (-PSK).

iHome does not recommend using iW3 on security networks configured with WEP security due to inconsistencies in compatibility with that aging security standard. The iW3 does not support WPA/WPA2 Enterprise security types.

For instructions on changing security types of your home network, refer to your Wi-Fi access-point's documentation. For best results, ensure your Wi-Fi access point is Wi-Fi-certified and is configured to support 802.11g communications.

Consumer Product Safety Guide

Safety Instructions

1. **Water and Moisture** – The unit should not be used near water. For example: near a bathtub, washbowl, kitchen sink, laundry tub, swimming pool or in a wet basement.
2. **Ventilation** – The unit should be situated so that its location or position does not interfere with its proper ventilation. For example, it should not be situated on a bed, sofa, rug or similar surface that may block ventilation openings. Also, it should not be placed in a built-in installation, such as a bookcase or cabinet, which may impede the flow of air through the ventilation openings.
3. **Heat** – The unit should be situated away from heat sources such as radiators, heat registers, stoves or other appliances (including amplifiers) that produce heat.
4. **Power Sources** – The unit should be connected to a power supply only of the type described in the operating instructions or as marked on the appliance.
5. **Power Cable Protection** – Power supply cables should be routed so that they are not likely to be walked on or pinched by items placed upon or against them. It is always best to have a clear area from where the cable exits the unit to where it is plugged into an AC socket.
6. **Cleaning** – The unit should be cleaned only as recommended. See the Maintenance section of this manual for cleaning instructions.
7. **Objects and Liquid Entry** – Care should be taken so that objects do not fall and liquids are not spilled into any openings or vents located on the product.
8. **Attachments** – Do not use attachments not recommended by the product manufacturer.
9. **Lightning and Power Surge Protection** – Unplug the unit from the wall socket and disconnect the antenna or cable system during a lightning storm or when it is left unattended and unused for long periods of time. This will prevent damage to the product due to lightning and power-line surges.
10. **Overloading** – Do not overload wall sockets, extension cords, or integral convenience receptacles as this can result in a risk of fire or electric shock.
11. **Damage Requiring Service** – The unit should be serviced by qualified service personnel when:
 - A. the power supply cable or plug has been damaged.
 - B. objects have fallen into or liquid has been spilled into the enclosure.
 - C. the unit has been exposed to rain.
 - D. the unit has been dropped or the enclosure damaged.
 - E. the unit exhibits a marked change in performance or does not operate normally.
12. **Antenna** – Do not connect an external antenna to the unit (other than that provided).
13. **Periods of None Use** – If the unit is to be left unused for an extended period of time, such as a month or longer, the power cable should be unplugged from the unit to prevent damage or corrosion.
14. **Servicing** – The user should not attempt to service the unit beyond those methods described in the user's operating instructions. Service methods not covered in the operating instructions should be referred to qualified service personnel.

FCC Statement

FCC ID: EMOiW3. IC: 986B-iW3

This equipment has been tested and found to comply with the limits for a Class B digital device, pursuant to part 15 of the FCC Rules. These limits are designed to provide reasonable protection against harmful interference in a residential installation. This equipment generates uses and can radiate radio frequency energy and, if not installed and used in accordance with the instructions, may cause harmful interference to radio communications. However, there is no guarantee that interference will not occur in a particular installation. If this equipment does cause harmful interference to radio or television reception, which can be determined by turning the equipment off and on, the user is encouraged to try to correct the interference by one or more of the following measures:

- Reorient or relocate the receiving antenna.
- Increase the separation between the equipment and receiver.
- Connect the equipment into an outlet on a circuit different from that to which the receiver is connected.
- Consult the dealer or an experienced radio/TV technician for help.

Modifying or tampering with your system's internal components can cause a malfunction and might invalidate the system's warranty and void your FCC authorization to operate it.

The separation distance between the equipment and the user shall not be less than 20 cm.

This Class B digital apparatus complies with Canadian ICES-003. Cet appareil numérique de la classe B est conforme à la norme NMB-003 du Canada.

FCC Radiation Exposure Statement

This device complies with FCC radiation exposure limits set forth for an uncontrolled environment and it also complies with Part 15 of the FCC RF Rules. This transmitter must not be co-located or operating in conjunction with any other antenna or transmitter.

Operation is subject to the following two conditions:

1. This device may not cause interference and
2. This device must accept any interference received, including interference that may cause undesired operation

Caution!

The manufacturer is not responsible for any radio or TV interference caused by unauthorized modifications to this equipment. Such modifications could void the user authority to operate the equipment.

Warranty

Limited 1 Year Warranty Information

iHome, a division of SDI Technologies Inc. (hereafter referred to as SDI Technologies), warrants this product to be free from defects in workmanship and materials, under normal use and conditions, for a period of 1 Year from the date of original purchase.

Should this product fail to function in a satisfactory manner, it is best to first return it to the store where it was originally purchased.

Should this fail to resolve the matter and service still be required by reason of any defect or malfunction during the warranty period, SDI Technologies will repair or, at its discretion, replace this product without charge (except for a \$30.00 charge for handling, packing, return UPS/postage, and insurance). This decision is subject to verification of the defect or malfunction upon delivery of this product to the Factory Service Center listed below. The product must include proof of purchase, including date of purchase. The fee for service without proof of purchase is \$60.00.

Before returning this product for service:

Before returning this product for service, please check our support section at www.ihomeaudio.com/support or call our customer service team to resolve any problems you may be experiencing.

If service is still required:

1. Pack unit in a well padded, heavy corrugated box.
2. Enclose a photocopy of your sales receipt, credit card statement, or other proof of the date of purchase, if within the warranty period.
3. Enclose a check or money order payable to the order of SDI Technologies, for the sum of \$30.00 (\$60.00 without proof of purchase).
4. Send the unit prepaid and insured, to the Factory Service Center listed below.

Consumer Repair Department

SDI Technologies Inc.
1330 Goodyear Dr.
El Paso, TX 79936-6420

Questions? Visit www.ihomeaudio.com/support/airplay

Toll Free Customer Service: 1-800-288-2792

©SDI Technologies 2012 All rights Reserved.

iW3 09032012-0
Made in China

Disclaimer of Warranty:

NOTE: This warranty is valid only if the product is used for the purpose for which it was designed. It does not cover (i) products which have been damaged by negligence or willful actions, misuse or accident, or which have been modified or repaired by unauthorized persons; (ii) cracked or broken cabinets, or units damaged by excessive heat; (iii) damage to digital media players, computers, routers, CD's or tape cassettes (if applicable); (iv) the cost of shipping this product to the Factory Service Center and its return to the owner.

This warranty is valid only in the United States of America and does not extend to owners of the product other than to the original purchaser. In no event will SDI Technologies or any of its affiliates, contractors, resellers, their officers, directors, shareholders, members or agents be liable to you or any third party for any consequential or incidental damages, any lost profits, actual, exemplary or punitive damages. (Some states do not allow limitations on implied warranties or exclusion of consequential damages, so these restrictions may not apply to you.) This warranty gives you specific legal rights, and you may also have other rights which vary from state to state.

Your acknowledgment and agreement to fully and completely abide by the above mentioned disclaimer of warranty is contractually binding to you upon your transfer of currency (money order, cashier's check, or credit card) for purchase of your SDI Technologies product.

 is a registered trademarks of SRS Labs, Inc. TruBass technology is incorporated under license from SRS Labs, Inc.

SRS WOW®, which features TruBass®, significantly improves the playback quality of audio, delivering a dynamic 3D entertainment experience with deep, rich bass and high frequency clarity for crisp detail.

iHome
AIR SERIES

Free Manuals Download Website

<http://myh66.com>

<http://usermanuals.us>

<http://www.somanuals.com>

<http://www.4manuals.cc>

<http://www.manual-lib.com>

<http://www.404manual.com>

<http://www.luxmanual.com>

<http://aubethermostatmanual.com>

Golf course search by state

<http://golfingnear.com>

Email search by domain

<http://emailbydomain.com>

Auto manuals search

<http://auto.somanuals.com>

TV manuals search

<http://tv.somanuals.com>