

vanté

NEWBORN/INFANT CAR SEAT

Century

DEDICATED TO QUALITY

Instruction Manual



Para instrucciones en Español,
llamar al: 1-800-837-4044

www.centuryproducts.com

Keep instructions for future
use.

**Avoid injury or death -
Read and understand this manual!
Use rear-facing only!**

5009-11-010

11/01

Download from www.Somanuals.com. All Manuals Search And Download.

TABLE OF CONTENTS

This instruction manual is for:

- Vanté Newborn/Infant Car Seats With 3-Point Harness
- Vanté Newborn/Infant Car Seats With 5-Point Harness

Instructions for these models *are the same* unless otherwise noted.

W Before You Begin

Important Information.....	1
Warnings	2
Basic Information.....	4

W Car Seat Use

Height & Weight Limits.....	5
Installation With Base.....	6
Installation Without Base.....	8
Placing Child in Car Seat.....	10
Operations and Adjustments.....	12
• Buckle	
• Harness Tie	
• Adjustable Handle	
• Removing Car Seat from Base	
• Adjustable Base	
• Adjusting or Changing Harness Straps	
• Changing Crotch Strap Positions	

W Special Information

Vehicle Seat Belts.....	16
Locking Clip.....	21
Using with a Stroller.....	22
Additional Information.....	23
• Care and Cleaning	
• Aircraft Use	
• Second Hand Car Seat	

IMPORTANT INFORMATION

No car seat can guarantee protection from injury in every situation, but proper use helps reduce the risk of serious injury or death.

W Registration Information

Child restraints (car seats) could be recalled for safety reasons. You must register this restraint to be reached in a recall. Fill out the registration card attached to car seat and mail today or send your name, address, and the restraint's model number and manufacturing date to:

Century Products
P.O. Box 100
Elverson, PA 19520-9973
or call 1-800-837-4044

For recall information:

- Call the U.S Government's Auto Safety Hotline at 1-800-424-9393 (202-366-0123 in D.C. area)
- www.nhtsa.dot.gov
- Call Century Products 1-800-837-4044

W Safety First Check List

- Read and understand instruction manual and car seat labels.
- Use car seat **rear-facing** only.
- Do not use in vehicle seat with air bag.
- Secure children in back seat whenever possible.
- Never leave child unattended.
- Install car seat securely.
- Only use a Vanté base when using car seat/carrier with a base.
- Do not use after date shown on back of car seat.
- Do not allow anyone (babysitter, relatives, etc.) to use car seat without first understanding all instructions.

WARNINGS - Prevent serious injury or death:

Failure to follow these instructions and car seat labels can result in child striking the vehicle's interior during a sudden stop or crash. Secure child restraint with a vehicle seat belt as shown in this manual.

Use car seat **rear-facing** only. Serious crippling injury or death can result if infant faces front of vehicle.

Vehicle seat belt system **MUST** hold car seat securely. Not all vehicle seat belts can be used with a car seat. If vehicle seat belt does not hold car seat securely, read "Vehicle Seat Belts" section.

DO NOT use **rear-facing** child restraint in a vehicle seating position equipped with an air bag. Child's head and neck may be seriously injured when an inflating air bag hits back of child restraint.

Never put a car seat in a front vehicle seat unless recommended by vehicle owner's manual. National Highway Traffic Safety Administration (NHTSA) alerts vehicle owners that, according to accident statistics, children up to age 12 are safer in the back seat. For vehicles with air bags, refer to vehicle owner's manual for child restraint installation information.

If car seat is in a crash, it must be replaced. **DO NOT use it again!** A crash can cause unseen damage and using it again could result in serious injury or death.

WARNINGS - *Prevent serious injury or death (continued):*

DO NOT use car seat if it is damaged or missing parts.

DO NOT use accessories or parts other than those provided by Century or Graco. Their use could alter the performance of the car seat.

Car seat must be properly leveled:

- **Too reclined** can result in injury or ejection.
- **Too upright** can result in breathing difficulties.

Never leave infant unattended, even when sleeping.

Strangulation Hazard: Child can strangle in loose harness straps. Never leave child in carrier when straps are loose or undone.

Fall Hazard: Child's movement can slide carrier. Never place carrier near edges of countertops, tables or other elevated surfaces.

Suffocation Hazard: Infant carrier can roll over on soft surfaces and suffocate child. Never place carrier on beds, sofas or other soft surfaces.

Avoid serious injury due to falls. Be sure handle "locks" into carrying position before carrying infant. If handle is not securely locked, car seat can flip forward causing infant to fall and be seriously injured.

BASIC INFORMATION

W Certification

This car seat meets or exceeds all applicable requirements of Federal Motor Vehicle Safety Standard 213 for use in motor vehicles and aircraft.

W Car Seat Useful Life

DO NOT use after date shown on back of car seat due to changing requirements and normal wear and tear.

Look for:

Do not use this car seat after December

Year

W Unoccupied Car Seat

Always secure car seat with a vehicle seat belt, even when unoccupied. An unsecured car seat can injure passengers.

W Vehicle Seat Protection

Protect vehicle seat. Use a car seat mat, towel or thin blanket under and behind car seat.

W Dangerous Vehicle Seats

Do not use car seat on rear-facing or side-facing vehicle seats.

W Warm Weather

Car seat parts can get very hot in the sun or warm weather.

To avoid burns, always check before putting child in car seat.

HEIGHT & WEIGHT LIMITS

This car seat is designed for *rear-facing* use only by an infant whose:

- Weight is less than 22 lbs (10 kg) and;
- Height is less than 29 inches (73.7 cm)

W Preterm or Low Birth Weight Infants

A preterm or low birth weight infant may be at special risk in a vehicle or aircraft.

According to the American Academy of Pediatrics, these infants may suffer breathing difficulties if improperly reclined in a car seat.

Century advises that you have your physician or hospital staff evaluate your infant and recommend the proper car seat or car bed **before** you and your infant leave the hospital.

INSTALLATION WITH BASE

- 1** Place base *rear-facing* on vehicle seat.
(Refer to illustration on Page 7)
- 2** Thread vehicle lap belt through base belt **Tabs** and buckle belt.
NOTE: Vehicle shoulder belt must **NOT** be placed under belt **Tabs**.
- 3** Press down firmly on base to compress vehicle seat cushion while tightening vehicle lap belt (*fig. a*).
- 4** Pull front to back and left to right to check for secure installation (*fig. b*). Vehicle lap belt **MUST** stay tight.
If not secure, see “Vehicle Seat Belts” section.
- 5** Put car seat in base and pull up on car seat to be sure it is locked in base.
- 6** Place child in car seat and check for secure installation (see **4**).
- 7** Adjust handle to a position behind car seat.
- 8** Check level indicator on base.
Ball **MUST** be entirely in green zone (*fig. c*).
If necessary adjust **Foot**.
NOTE: Vehicle **must** be on level ground and child in car seat when leveling.

INSTALLATION WITH BASE (continued)

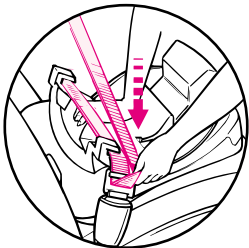
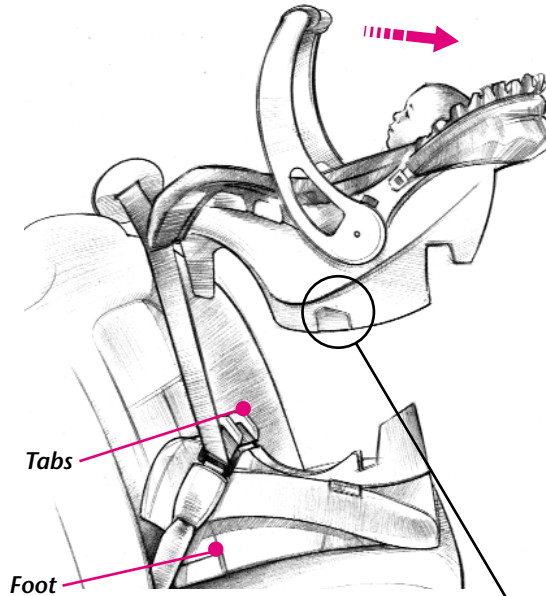

(fig. a)

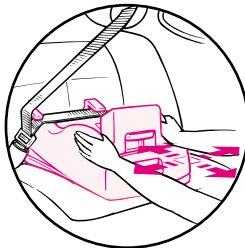

(fig. b)

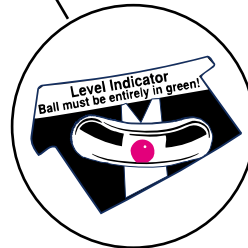

(fig. c)

INSTALLATION **WITHOUT** BASE

- 1** Place car seat *rear-facing* on vehicle seat.
(Refer to illustration on Page 9)
- 2** Thread vehicle lap belt through car seat *Slots* and buckle belt.
NOTE: Vehicle shoulder belt must **NOT** be placed through car seat *Slots*.
- 3** Press down firmly on car seat to compress vehicle seat cushion while tightening vehicle lap belt (*fig. a*).
- 4** Pull front to back and left to right to check for secure installation (*fig. b*). Vehicle lap belt **MUST** stay tight.

If not secure, see “Vehicle Seat Belts” section.
- 5** Check level indicator on car seat.

Ball **MUST** be entirely in green zone (*fig. c*). If necessary place rolled *Towels* under car seat at vehicle seat crease.

NOTE: Vehicle **must** be on level ground and child in car seat when leveling.
- 8**

INSTALLATION **WITHOUT** BASE (continued)

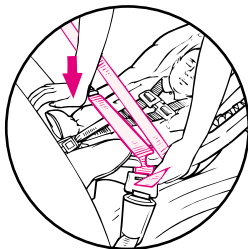
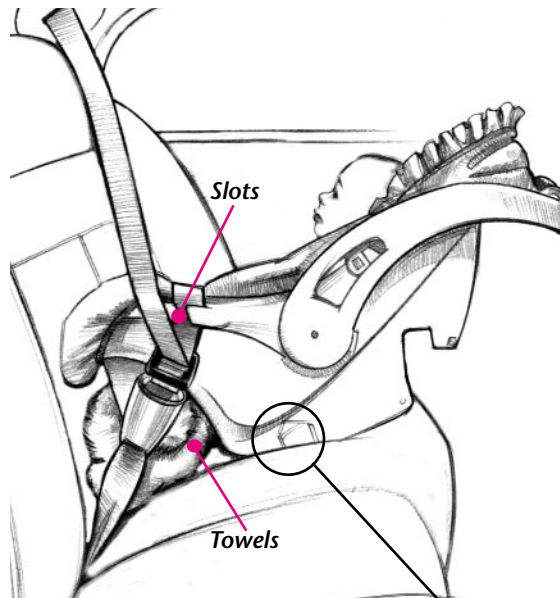

(fig. a)

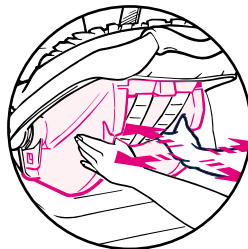

(fig. b)

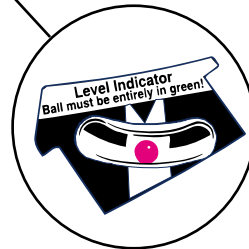

(fig. c)

PLACING CHILD IN CAR SEAT



WARNING

To prevent serious injury or death:

- **Keep harness straps snug and positioned on shoulders. Periodically check adjustments.**
- **Do not use strap covers, blankets, cushions, or padding under harness straps or child unless provided by Century or Graco.**
- **Baby must be dressed in clothing with arms and legs that will not interfere with buckling harness.**

Check harness system:

- Harness straps must be through slots *at or just below* shoulders.

5-Point Models Only:

- Crotch strap *must* be through opening closest to but not under child.

3-Point Models Only:

- Buckle tongue *must* be in slot closest to but not under child.

- 1 Place child in car seat with child's back flat against back of car seat.
- 2 Place harness straps over child's shoulders and insert tongue(s) into buckle to lock.

Pull up on tongue(s) to be sure they are locked.
- 3 Close harness tie:

Position harness tie at arm pit level.
- 4 Adjust harness straps to be snug with just enough room to insert one finger between child's chest and harness straps (*fig. a*).

For 5-Point models, check that harness straps on chest and *thighs* are snug.

- 5 A rolled towel can be used on each side to support small children (*fig. b*). Be sure towels do not interfere with harness system.

PLACING CHILD IN CAR SEAT (continued)

3-Point
Models

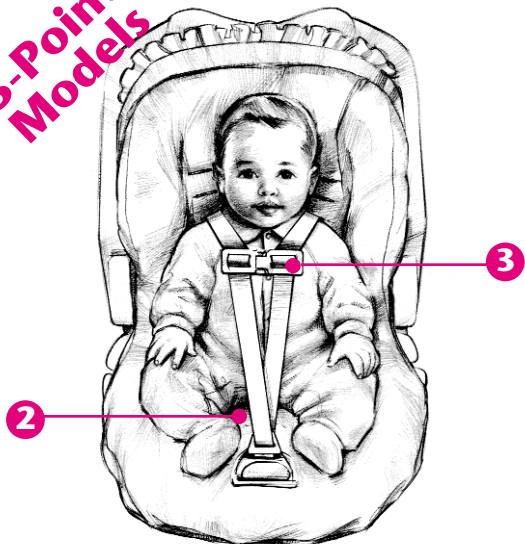

5-Point
Models

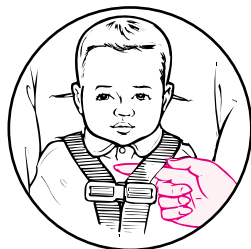
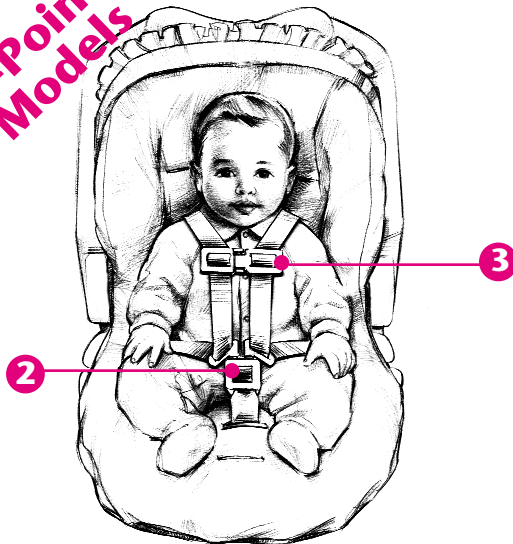

(fig. a)

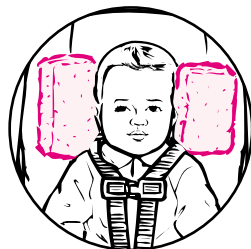

(fig. b)

OPERATIONS and ADJUSTMENTS

1

Buckle:

3-Point Models

- To buckle: Push tongue down into slot. Pull up on tongue to be sure it is locked.
- To unbuckle: Press red button and pull tongue out.

5-Point Models

- To buckle: Insert both tongues into buckle. Pull up on tongues to be sure they are locked.
- To unbuckle: Press red button and pull tongues out.

2

2-Piece Harness Tie:

- To open: Squeeze tabs and pull apart.
- To close: Snap halves together. Make sure harness tie is locked by pulling out on each half.

3

Adjustable Handle:

- Handle has three adjustment positions.
- Push in red buttons on each side of handle, rotate and release red buttons. Continue rotating handle to desired position until you hear a “click” sound.
- **IMPORTANT:** Before lifting car seat, place handle in “locked” upright carrying position.

4

Removing Car Seat from Base:

- Place handle in “locked” upright carrying position.
- Pull red release handle in base (*fig. a*).
- Lift car seat out of base.

5

Adjustable Base:

- Pull *Level Adjuster Handle* out (*fig. b*).
- Adjust *Foot* to desired position.
- Release adjustment handle. Be sure it retracts into slot.

OPERATIONS and ADJUSTMENTS (continued)

3-Point Models

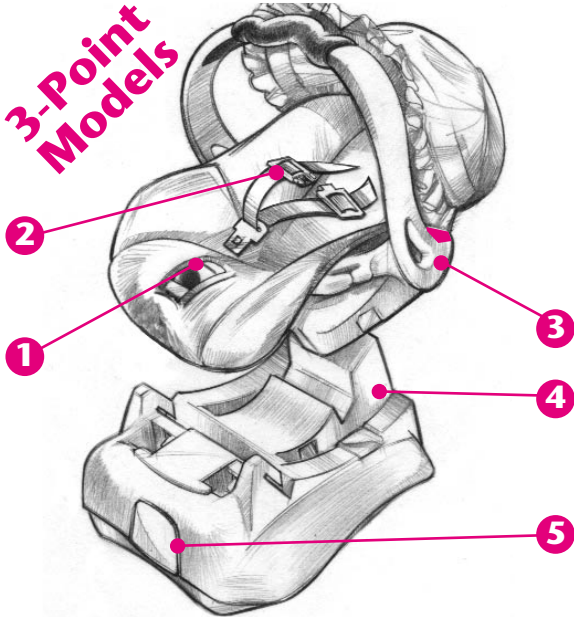

5-Point Models

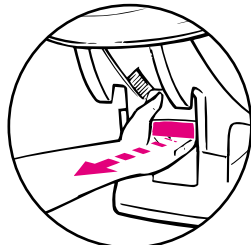
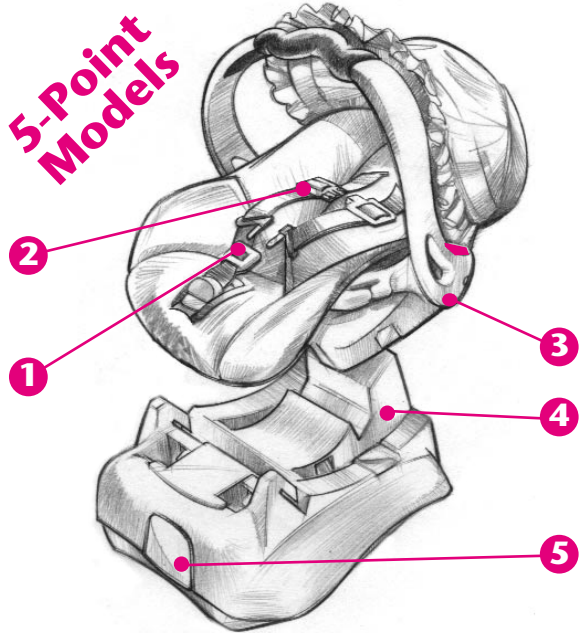

(fig. e)

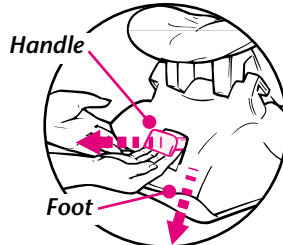

(fig. h)

OPERATIONS and ADJUSTMENTS (continued)

6 Adjusting or Changing Harness Straps (fig. c):

Harness straps must be through slots *at* or *below* shoulders.

- Press **Tab** to release metal **Rod** and lift **Rod** out of side **Pockets**.
- Slide metal **Rod** out of **Loops** of harness straps.
- If necessary to change slots, pull harness strap out of current **Slots** and thread through desired **Slots**.

IMPORTANT: Straps **MUST** be through **matching Slots** of seat pad and car seat.

- Adjust strap length by inserting metal **Rod** into any **Loop** that will provide proper snugness.
- Replace metal **Rod** into side **Pockets** and slide **Rod** down below **Tab**.

Make sure Tab holds metal Rod securely.

7 Changing Crotch Strap Positions (fig. d):

Buckle tongue **must** be in slot closest to but not under child.

5-Point Models Only

- From bottom of car seat, remove crotch strap **Clip**.
- From top of car seat, rethread crotch strap through desired **Opening**.
- Re-attach crotch strap **Clip exactly** as shown.

Pull on buckle to make sure it is held securely.

OPERATIONS and ADJUSTMENTS (continued)

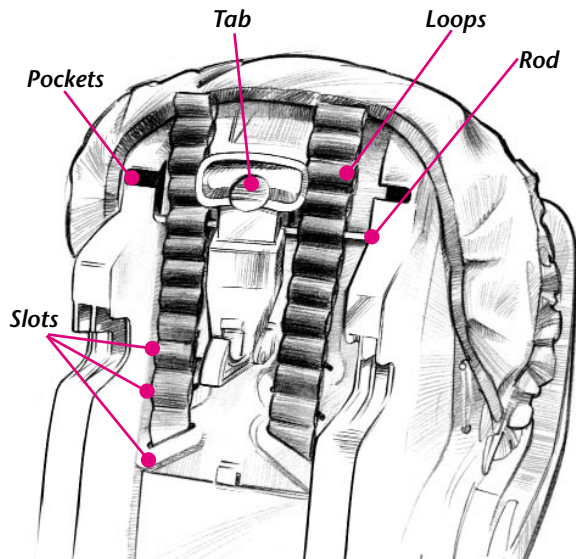

(fig. c)

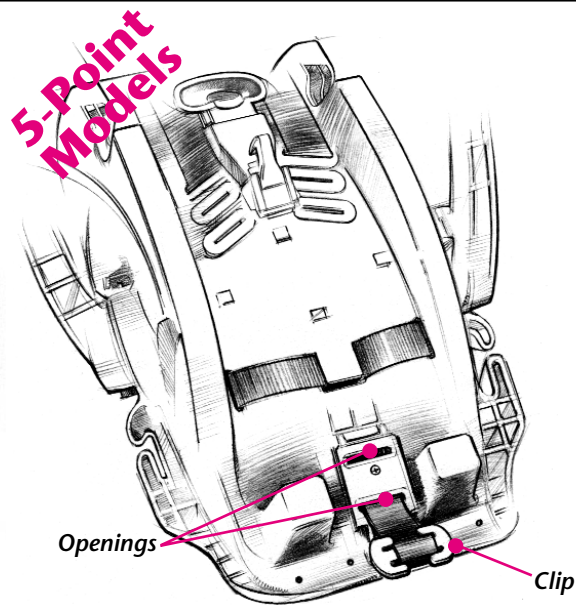

(fig. d)

**5-Point
Models**

VEHICLE SEAT BELTS



WARNING

Not all vehicle seat belts can be used with a car seat:

Car seat must be held securely at all times by a lap belt (or lap belt portion of a lap/shoulder belt) that will not change length while driving.

To provide the best installation of the car seat:

- Read the vehicle owner's manual regarding car seat installation and seat belt use with car seat.
- Follow all instruction labels on vehicle seat belt and car seat.

If car seat is not held securely after following instructions in this manual, vehicle seat belt labels, and vehicle owner's manual:

- Move car seat to another seating location and try again, or
- Contact vehicle dealer for possible seat belt modification parts.

VEHICLE SEAT BELTS (continued)

W Belts Forward of Seat Crease

Vehicle seat belts located forward of seat crease may not securely hold car seat. Check vehicle owner's manual or see vehicle dealer for car seat installation requirements.

- *If approved for use with car seat, install car seat and check for secure installation by pulling car seat front to back. If car seat slides forward, DO NOT use these seat belts.*

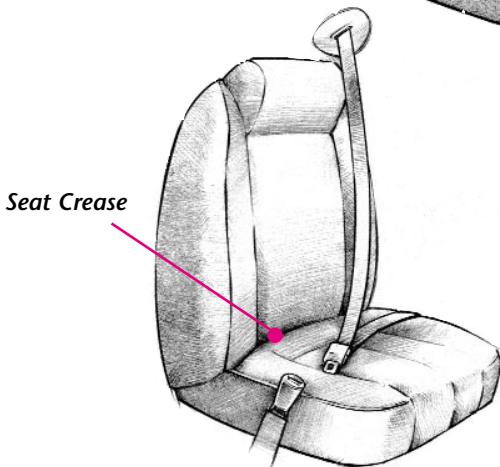
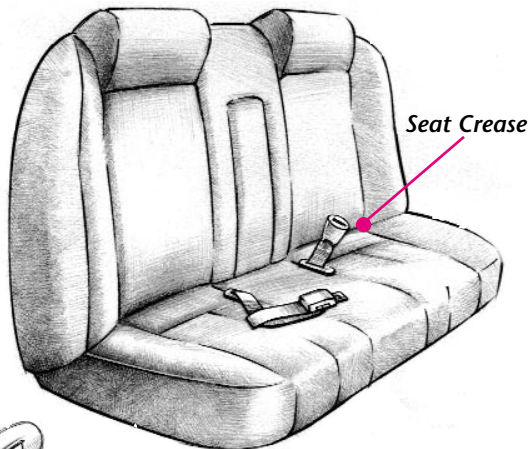

VEHICLE SEAT BELTS (continued)

W/Lap Belts - Manually Adjustable

The locking latch plate on some seat belts may slip and loosen after being buckled on car seat if positioned at a certain angle. If this happens, flip latch plate over (*fig. a*) and re-buckle. Test installation again to see if this works. If not, move car seat to another seating position.

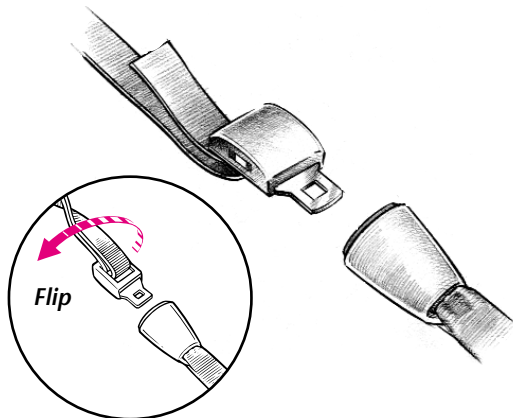

(fig. a)

W/Lap Belts - With Retractor

Lap belts with retractors may or may not hold a car seat securely.

Follow these steps to determine if you have a retractor system that will hold car seat securely:

- Pull belt all the way out.
- Allow belt to retract about 6 inches (15 cm).
- Pull out on belt again.

If belt is locked and you **cannot** pull the belt out any further, you have an Automatic Locking Retractor which may be used with a car seat. Remember, when installing a car seat, pull belt all the way out, buckle belt, and then tighten.

If you **can** pull the belt out again (step c), you have an Emergency Locking Retractor which **must not** be used with a car seat.

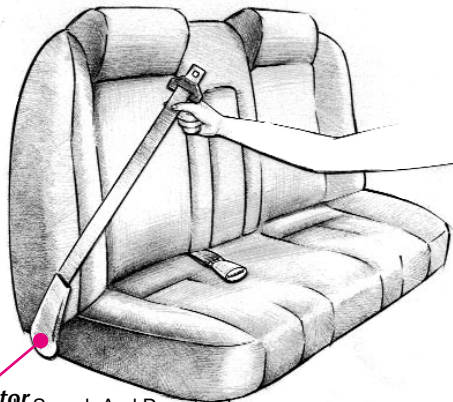

VEHICLE SEAT BELTS (continued)

W Passive Restraint - Lap Belt with Motorized Shoulder Belt

DO NOT use with any car seat.

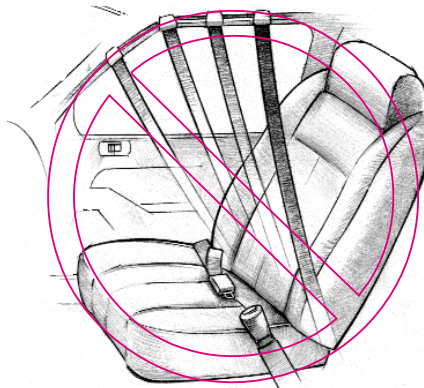

W Passive Restraint - Lap or Shoulder Belt Mounted on Door

DO NOT use with any car seat. Belts will not stay tight while driving.

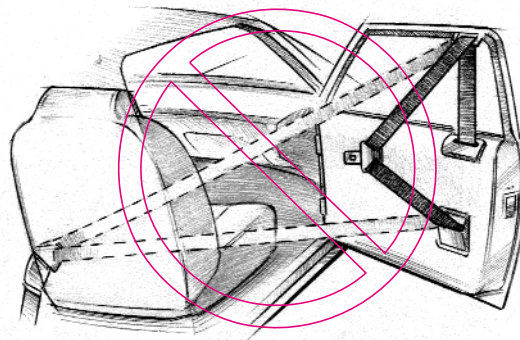

VEHICLE SEAT BELTS (continued)

W Combination Lap/Shoulder Belt with Sliding Latch Plate

Pull on latch plate (*fig. a*). If belt slides freely through latch plate, a locking clip **MUST** be used (see Locking Clip section).

Some combination lap/shoulder belts with sliding latch plates may be converted into an **“automatic locking mode”** that will allow use without a locking clip. See vehicle owner’s manual and label on vehicle belts for instructions.

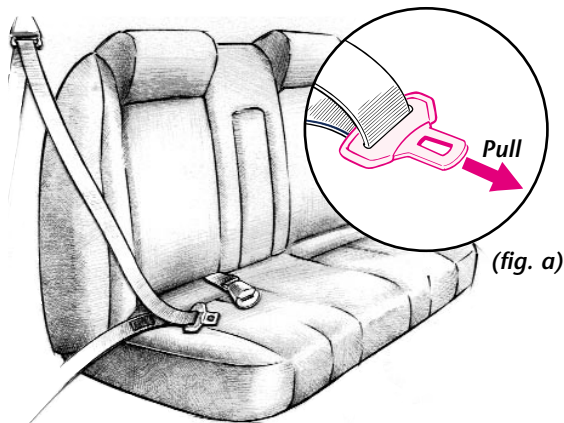

W Combination Lap/Shoulder Belt with Locking Latch Plate

The locking latch plate on some seat belts may slip and loosen after being buckled on car seat if positioned at a certain angle. If this happens, flip the latch plate over (*fig. b*) and re-buckle. Test installation again to see if this works. If not, move car seat to another seating position.

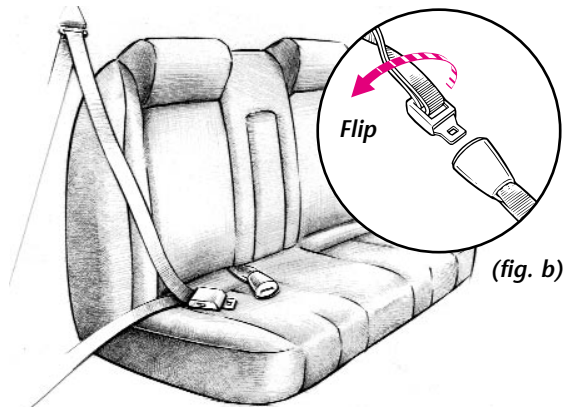

VEHICLE SEAT BELTS (continued)

W/Locking Clip

WARNING

Avoid serious injury or death:

- **Failure to use locking clip where required will result in car seat not being securely held in place.**
- **Remove locking clip from seat belts when not being used with car seat.**
- **DO NOT use locking clip as a vehicle seat belt shortener.**

You **MUST** use locking clip provided with car seat with a vehicle seat belt that slides freely through the latch plate or the lap belt cannot be tightly secured.

- 1** Install car seat and tighten vehicle seat belt.
- 2** Hold seat belts together at latch plate (*fig. a*) then unbuckle.
- 3** Slide locking clip on seat belts approximately 1/2 inch (1 cm) away from latch plate.
- 4** Re-buckle seat belt.

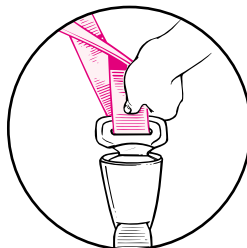

(*fig. a*)

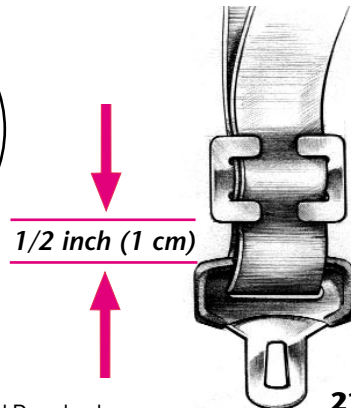

- 5** Test installation to see if car seat is secure.

If not secure, additional belt tightening may be required:

- Unbuckle vehicle seat belt.
- Hold belts together and remove locking clip.
- Shorten length of lap belt portion slightly by pulling belt through latch plate.
- Re-attach locking clip.
- Buckle vehicle seat belt.

HINT: Press car seat further down into vehicle seat cushion to help buckle vehicle seat belt.

Test installation to see if car seat is secure. If not secure, repeat above step until secure.

STROLLER USE

WARNING

Prevent injuries from falls:

- **Make sure child is securely buckled into car seat.**
- **Make sure car seat locks onto stroller.**
- **Avoid tip over of stroller. Use caution on turns and irregular and ramped surfaces.**
- **Never leave child unattended.**

Using the Car Seat with a Graco® or Century® Stroller

Use only with strollers that are part of the Graco® Century® Travel System.

Refer to stroller instruction sheet for details about how to attach the infant restraint to your stroller. If you do not have an instruction sheet, please call toll-free, 1-888-224-6549 to obtain one, or visit our website, www.gracobaby.com.

ADDITIONAL INFORMATION

W Care & Cleaning

Seat Pad:

Machine-wash separately on gentle cycle and machine-dry on cool air setting or line dry.

Harness Straps:

Surface wash only with mild soap and damp cloth.

If harness straps are frayed or heavily soiled, they **MUST** be replaced.

Shell:

Wipe with mild solution of soap and water. Avoid wetting labels.

Never use household detergents: they can weaken plastic.

Buckle:

Rinse buckle with warm water. **DO NOT** use household detergents. Never lubricate buckle.



WARNING

Prevent serious injury or death:

- **Buckle must be properly latched.**
- **Periodically inspect and clean buckle to remove objects or debris that could prevent latching.**

ADDITIONAL INFORMATION (continued)

W Aircraft Use

This car seat is certified for use on aircraft (see label on car seat). Contact airline about their policy.

Use this car seat only on forward-facing aircraft seats.

Install car seat carrier (without base) on an aircraft the same way it is installed in a vehicle.

CAUTION: DO NOT use car seat base on an aircraft seat because aircraft seat belt buckle may interfere with the secure fit of the car seat carrier in the base.

W Second Hand Car Seat

Century advises against loaning or passing along car seat.



If a part is damaged, missing, or you need help or replacement parts, **DO NOT** return car seat to the store.

CALL US FIRST

Call toll-free 1-800-837-4044 from anywhere in the U.S. or Canada or fax at 1-610-286-4555.

or write us at:

Century Products
PO Box 100
Elverson, PA 19520-9974

Attention: Customer Service
Department



1 Fold instruction manual.

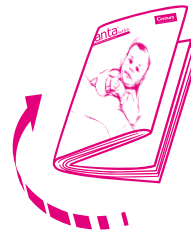

2 Store instruction manual behind tabs.

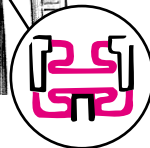
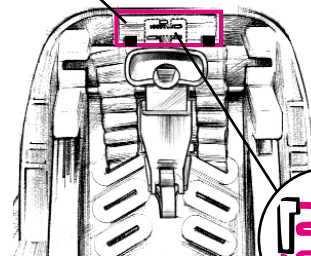

Store Locking Clip Behind Instruction Manual (fig. a). (Location may vary slightly.)

(fig. a)

Century Products
Graco Children's Products Inc.
A Division of Newell Rubbermaid

Attaching Cover

Pour attacher l'abri

Instalación de la tapa

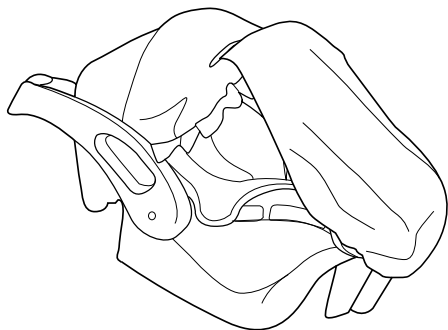

41413ZOL, 41313CRB

1

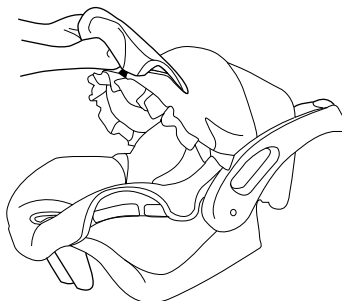

To use cover, lift VELCRO® tab and remove cover.

Pour utiliser l'abri, soulevez la languette de VELCRO® et enlevez l'abri.

Para usar la tapa, levante la lengüeta de VELCRO® y saque la tapa.

2

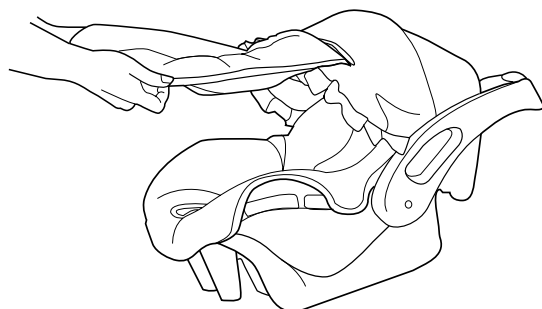

Pull cover down over the front of the seat. Make sure the elastic part of cover is completely wrapped around foot of carrier.

Abaissez l'abri sur l'avant du siège. Assurez-vous que la partie élastique de l'abri est complètement enveloppée autour du pied du porte-bébé.

Tire la tapa hacia abajo sobre el frente del asiento. Asegúrese que la parte elástica de la tapa esté completamente alrededor del pie del transportador.

3

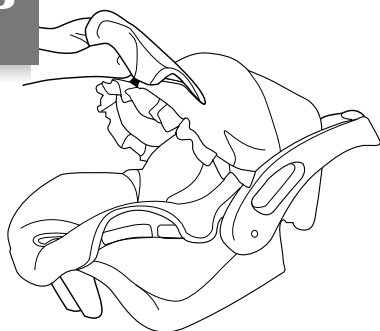

When not in use you must fold cover and store in the pocket located in the front of the canopy.

Lorsque l'abri n'est pas utilisé, vous devez le plier et l'entreposer dans la pochette localisée à l'avant du baldaquin.

Cuando no lo usa debe plegar la tapa y guardarla en el bolsillo que se encuentra en el frente de la capota.

▲WARNING: Prevent Suffocation: Cover must be attached at foot of carrier or stored in canopy pocket.

Harness must be securely fastened at all times.

▲MISE EN GARDE: Pour prévenir la suffocation: l'abri doit être attachée au pied du porte-bébé ou doit être entreposée dans la pochette du baldaquin.

Le harnais doit être attaché solidement en tout temps.

▲ADVERTENCIA: Para prevenir la asfixia: La tapa debe estar conectada en el pie del transportador o guardada en el bolsillo de la capota.

El arnés debe estar asegurado en todo momento.

4

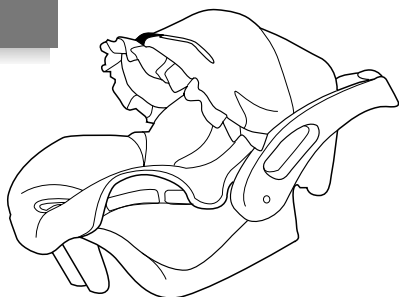

Car seat should look like this when cover is in storage pocket.

Le siège d'auto devrait avoir cette apparence lorsque l'abri est dans la pochette de rangement.

El asiento para automóvil debe tener este aspecto cuando la tapa está en el bolsillo de almacenamiento.

Free Manuals Download Website

<http://myh66.com>

<http://usermanuals.us>

<http://www.somanuals.com>

<http://www.4manuals.cc>

<http://www.manual-lib.com>

<http://www.404manual.com>

<http://www.luxmanual.com>

<http://aubethermostatmanual.com>

Golf course search by state

<http://golfingnear.com>

Email search by domain

<http://emailbydomain.com>

Auto manuals search

<http://auto.somanuals.com>

TV manuals search

<http://tv.somanuals.com>