



GE Consumer & Industrial
Multilin



EPM 6000

MULTI-FUNCTION POWER METER

EPM 6000 Instruction Manual

Software Revision: 4.5

Manual P/N: 1601-0215-A4

Manual Order Code: GEK-106558C

Copyright © 2007 GE Multilin

GE Multilin

215 Anderson Avenue, Markham, Ontario

Canada L6E 1B3

Tel: (905) 294-6222 Fax: (905) 201-2098

Internet: <http://www.GEmultilin.com>



GE Multilin's Quality Management System is registered to ISO9001:2000
QMI # 005094

Table of Contents

1: OVERVIEW	INTRODUCTION	1-1
	DESCRIPTION	1-1
	HIGHLIGHTS	1-1
	FEATURES	1-3
	UNIVERSAL VOLTAGE INPUTS	1-3
	CURRENT INPUTS	1-3
	UTILITY PEAK DEMAND	1-3
	MEASURED VALUES	1-4
	ORDERING	1-5
	ORDER CODES	1-5
	SPECIFICATIONS	1-6
	INPUTS/OUTPUTS	1-6
	METERING	1-6
	ENVIRONMENTAL	1-7
	COMMUNICATIONS	1-7
	MECHANICAL PARAMETERS	1-7
	APPROVALS	1-8

2: ELECTRICAL BACKGROUND	THREE-PHASE POWER MEASUREMENT	2-1
	DESCRIPTION	2-1
	THREE-PHASE SYSTEM CONFIGURATIONS	2-2
	DESCRIPTION	2-2
	WYE CONNECTION	2-2
	DELTA CONNECTION	2-4
	BLONDELL'S THEOREM AND THREE-PHASE MEASUREMENT	2-5
	POWER, ENERGY, AND DEMAND	2-8
	DESCRIPTION	2-8
	POWER	2-8
	ENERGY	2-8
	DEMAND	2-10
	REACTIVE ENERGY AND POWER FACTOR	2-12
	REAL, REACTIVE, AND APPARENT POWER	2-12
	POWER FACTOR	2-13
	HARMONIC DISTORTION	2-14
	HARMONICS OF A NON-SINUSOIDAL WAVEFORM	2-14
	INDUCTIVE AND CAPACITIVE IMPEDANCE	2-15
	VOLTAGE AND CURRENT MONITORING	2-15
	WAVEFORM CAPTURE	2-16
	POWER QUALITY	2-17
	DESCRIPTION	2-17

3: INSTALLATION	MECHANICAL INSTALLATION	3-1
	DIMENSIONS	3-1
	ANSI INSTALLATION STEPS	3-2
	DIN INSTALLATION STEPS	3-3
	ELECTRICAL INSTALLATION	3-5

INSTALLATION CONSIDERATIONS	3-5
CT LEADS TERMINATED TO METER	3-6
CT LEADS PASS-THROUGH (NO METER TERMINATION)	3-6
QUICK CONNECT CRIMP CT TERMINATIONS	3-7
VOLTAGE AND POWER SUPPLY CONNECTIONS	3-7
GROUND CONNECTIONS	3-8
WIRING DIAGRAMS	3-9
DESCRIPTION	3-9
WYE, 4-WIRE WITH NO PTS AND 3 CTS, 3 ELEMENT	3-10
WYE, 4-WIRE WITH NO PTS AND 3 CTS, 2.5 ELEMENT	3-11
WYE, 4-WIRE WITH 3 PTS AND 3 CTS, 3 ELEMENT	3-12
WYE, 4-WIRE WITH 2 PTS AND 3 CTS, 2.5 ELEMENT	3-13
DELTA, 3-WIRE WITH NO PTS AND 2 CTS	3-14
DELTA, 3-WIRE WITH 2 PTS AND 2 CTS	3-15
CURRENT-ONLY MEASUREMENT (THREE-PHASE)	3-16
CURRENT-ONLY MEASUREMENT (DUAL-PHASE)	3-17
CURRENT-ONLY MEASUREMENT (SINGLE-PHASE)	3-18
COMMUNICATIONS SETUP	3-19
DESCRIPTION	3-19
IRDA COM1 PORT	3-19
RS485 COM2 PORT	3-19

4: USING THE METER

FRONT PANEL INTERFACE	4-1
DESCRIPTION	4-1
FACEPLATE ELEMENTS	4-1
FACEPLATE BUTTONS	4-2
PERCENTAGE OF LOAD BAR	4-3
WATT-HOUR ACCURACY TESTING (VERIFICATION)	4-4
CONFIGURING THE METER VIA THE FRONT PANEL	4-5
OVERVIEW	4-5
START UP	4-5
MAIN MENU	4-6
RESET MODE AND PASSWORD ENTRY	4-6
CHANGING SETTINGS IN CONFIGURATION MODE	4-9
DESCRIPTION	4-9
CONFIGURING THE SCROLL FEATURE	4-9
PROGRAMMING THE CONFIGURATION MODE SCREENS	4-10
CONFIGURING THE CT SETTING	4-11
CONFIGURING THE PT SETTING	4-12
CONFIGURING THE CONNECTION SETTING	4-13
CONFIGURING THE COMMUNICATION PORT SETTING	4-14
OPERATING MODE	4-17
DESCRIPTION	4-17

5: COMMUNICATIONS

MODBUS COMMUNICATIONS	5-1
MEMORY MAP DESCRIPTION	5-1
MEMORY MAP	5-1
MODBUS MEMORY MAP NOTES	5-7
MODBUS MEMORY MAP DATA FORMATS	5-9
DNP POINT MAPPING	5-10
DNP POINT MAPS	5-10
DNP POINT MAP NOTES	5-12

DNP IMPLEMENTATION	5-13
OVERVIEW	5-13
DATA LINK LAYER	5-13
TRANSPORT LAYER	5-13
APPLICATION LAYER	5-14
DNP OBJECTS AND VARIATIONS	5-15
DESCRIPTION	5-15
BINARY OUTPUT STATUS (OBJECT 10, VARIATION 2)	5-15
CONTROL RELAY OUTPUT (OBJECT 12, VARIATION 1)	5-15
32-BIT BINARY COUNTER WITHOUT FLAG (OBJECT 20, VARIATION 4)	5-16
16-BIT ANALOG INPUT WITHOUT FLAG (OBJECT 30, VARIATION 5)	5-16
CLASS 0 DATA (OBJECT 60, VARIATION 1)	5-17
INTERNAL INDICATIONS (OBJECT 80, VARIATION 1)	5-17

6: MISCELLANEOUS

NAVIGATION MAPS	6-1
INTRODUCTION	6-1
MAIN MENU SCREENS	6-2
OPERATING MODE SCREENS	6-3
RESET MODE SCREENS	6-4
CONFIGURATION MODE SCREENS	6-5
REVISION HISTORY	6-6
RELEASE DATES	6-6
CHANGES TO THE MANUAL	6-6
WARRANTY	6-8
GE MULTILIN WARRANTY	6-8



EPM 6000 Multi-function Power Metering System

Chapter 1: Overview

1.1 Introduction

1.1.1 Description

The EPM 6000 is a multifunction power meter designed to be used in electrical substations, panel boards and as a power meter for OEM equipment. The unit provides multifunction measurement of electrical parameters.

The unit is designed with advanced measurement capabilities, allowing it to achieve high performance accuracy. The EPM 6000 is specified as a 0.2% class energy meter for billing applications as well as a highly accurate panel indication meter.

The EPM 6000 provides a host of additional capabilities, including standard RS485 Modbus Protocol and an IrDA port remote interrogation.

1.1.2 Highlights

The following EPM 6000 features are detailed in this manual:

- 0.2% class revenue certifiable energy and demand metering
- Meets ANSI C12.20 (0.2%) and IEC 687 (0.2%) classes
- Multifunction measurement including voltage, current, power, frequency, energy
- Percentage of load bar for analog meter perception
- Easy-to-use faceplate programming
- IrDA port for PDA remote read
- RS485 Modbus communications



FIGURE 1-1: EPM 6000 Highlights

1.2 Features

1.2.1 Universal Voltage Inputs

Voltage Inputs allow measurement to 416 V line-to-neutral and 721 V line-to-line. This insures proper meter safety when wiring directly to high voltage systems. One unit will perform to specification on 69 V, 120 V, 230 V, 277 V, and 347 V systems.

1.2.2 Current Inputs

The EPM 6000 current inputs use a unique dual input method.

- **Method 1 – CT Pass Through:** The CT passes directly through the meter without any physical termination on the meter. This insures that the meter cannot be a point of failure on the CT circuit. This is preferable for utility users when sharing relay class CTs. No burden is added to the secondary CT circuit.
- **Method 2 – Current “Gills”:** This unit additionally provides ultra-rugged termination pass-through bars that allow CT leads to be terminated on the meter. This, too, eliminates any possible point of failure at the meter. This is a preferred technique for insuring that relay class CT integrity is not compromised (the CT will not open in a fault condition).

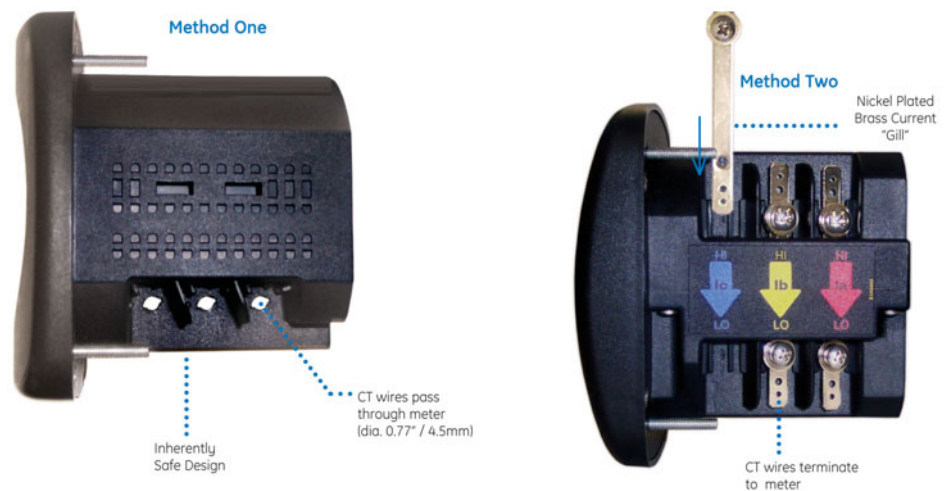

FIGURE 1-2: Current Input Connections

1.2.3 Utility Peak Demand

The EPM 6000 provides user-configured Block (fixed) or Rolling window demand. This feature allows you to set up a customized demand profile. Block window demand is demand used over a user-defined demand period (usually 5, 15, or 30 minutes). Rolling window demand is a fixed window demand that moves for a user-specified subinterval period. For example, a 15-minute demand using 3 subintervals and providing a new demand reading every 5 minutes, based on the last 15 minutes.

Utility demand features can be used to calculate kW, kvar, kVA and PF readings. All other parameters offer maximum and minimum capability over the user-selectable averaging period. Voltage provides an instantaneous maximum and minimum reading which displays the highest surge and lowest sag seen by the meter.

1.2.4 Measured Values

The EPM 6000 provides the following measured values all in real time and some additionally as average, maximum, and minimum values.

Table 1–1: EPM 6000 Measured Values

Measured Values	Real Time	Average	Maximum	Minimum
Voltage L-N	X		X	X
Voltage L-L	X		X	X
Current per phase	X	X	X	X
Watts	X	X	X	X
vars	X	X	X	X
VA	X	X	X	X
Power Factor (PF)	X	X	X	X
Positive watt-hours	X			
Negative watt-hours	X			
Net watt-hours	X			
Positive var-hours	X			
Negative var-hours	X			
Net var-hours	X			
VA-hours	X			
Frequency	X		X	X
%THD	X		X	X
Voltage angles	X			
Current angles	X			
% of load bar	X			

1.3 Ordering

1.3.1 Order Codes

The order codes for the EPM 6000 are indicated below.

Table 1–2: EPM 6000 Order Codes

	PL6000	-	*	-	*	-	*	
Base Unit	PL6000							EPM 6000 Power Metering System
System			5					50 Hz AC frequency system
Frequency			6					60 Hz AC frequency system
Current Input					1A			1 A secondary CT
					5A			5 A secondary CT
THD and Pulse Output							0	No THD or pulse output option
							THD	THD, limit alarms, and 1 KYZ pulse output

For example, to order an EPM 6000 for 60 Hz system with a 1 A secondary CT input and no THD or pulse output option, select order code PL6000-6-1A-0. The standard unit includes display, all current/voltage/power/frequency/energy counters, percent load bar, RS485, and IrDA communication ports.

1.4 Specifications

1.4.1 Inputs/Outputs

POWER SUPPLY

Range:.....D2 Option: Universal, 90 to 265 V AC at 50/60Hz, or 100 to 370 V DC
 D Option: 18 to 60 V DC
 Power consumption:.....5 VA, 3.5 W

VOLTAGE INPUTS (MEASUREMENT CATEGORY III)

Range:.....Universal, Auto-ranging up to 416 V AC L-N, 721 V AC L-L
 Supported hookups:.....3-element Wye, 2.5-element Wye, 2-element Delta, 4-wire Delta
 Input impedance:1 MOhm/phase
 Burden:.....0.0144 VA/phase at 120 Volts
 Pickup voltage:10 V AC
 Connection:Screw terminal (see *Voltage Connection* on page 3–8)
 Maximum input wire gauge:AWG #12 / 2.5 mm²
 Fault withstand:Meets IEEE C37.90.1
 Reading:.....Programmable full-scale to any PT ratio

CURRENT INPUTS

Class 10:.....5 A nominal, 10 A maximum
 Class 2:.....1 A nominal, 2 A maximum
 Burden:.....0.005 VA per phase maximum at 11 A
 Pickup current:.....0.1% of nominal
 Connections:.....O or U lug (see *CT Leads Terminated to Meter* on page 3–6);
 Pass-through wire, 0.177" / 4.5 mm maximum diameter
 (see *Pass-Through Wire Electrical Connection* on page 3–7);
 Quick connect, 0.25" male tab
 (see *Quick Connect Electrical Connection* on page 3–7)
 Fault Withstand:.....100 A / 10 seconds, 300 A / 3 seconds, 500 A / 1 second
 Reading:.....Programmable full-scale to any CT ratio

1.4.2 Metering

MEASUREMENT METHODS

Voltage and current:.....true RMS
 Power:.....sampling at 400+ samples/cycle on all channels measured; readings simultaneously
 A/D conversion:.....6 simultaneous 24-bit analog-to-digital converters

UPDATE RATE

Watts, vars, and VA:100 ms (10 times per second)
 All other parameters:.....1 second

ACCURACY

Measured Parameters	Display Range	Accuracy
Voltage L-N	0 to 9999 kV or scalable	0.1% of reading
Voltage L-L	0 to 9999 V or kV scalable	0.1% of reading
Current	0 to 9999 A or kA	0.1% of reading
+/- Watts	0 to 9999 W, kW, or MW	0.2% of reading
+/- Wh	5 to 8 digits (programmable)	0.2% of reading
+/- vars	0 to 9999 vars, kvars, Mvars	0.2% of reading
+/- varh	5 to 8 digits (programmable)	0.2% of reading
VA	0 to 9999 VA, kVA, MVA	0.2% of reading
VAh	5 to 8 digits (programmable)	0.2% of reading
Power Factor (PF)	±0.5 to 1.0	0.2% of reading
Frequency	45 to 65 Hz	0.01 Hz
% THD	0 to 100%	2.0% F.S.
% Load Bar	10 digit resolution scalable	1 to 120% of reading

NOTE: Typical results are more accurate.

1.4.3 Environmental**TEMPERATURE AND HUMIDITY**

Storage:.....-40 to 85°C

Operating:.....-30 to 70°C

Humidity:.....up to 95% RH, non-condensing

Faceplate rating:NEMA 12 (water resistant), mounting gasket included

1.4.4 Communications**COMMUNICATIONS FORMAT**

Types:.....RS485 port through back plate
IrDA port through face plate

COMMUNICATIONS PORTS

Protocol:.....Modbus RTU, Modbus ASCII, DNP 3.0

Baud rate:9600 to 57600 bps

Port address:001 to 247

Data format:8 bits, no parity

1.4.5 Mechanical Parameters**DIMENSIONS**

Size:.....4.25" × 4.82" × 4.85" (L × W × H)

105.4 mm × 123.2 mm × 123.2 mm (L × W × H)

Mounting:mounts in 92 mm square DIN or ANSI C39.1 4-inch round cut-out

Weight:.....2 pounds / 0.907 kg

Shipping.....ships in 6-inch / 152.4 mm cube container

1.4.6 Approvals

TYPE TESTING

IEC 687 (0.2% accuracy)

ANSI C12.20 (0.2% accuracy)

ANSI (IEEE) C37.90.1:Surge Withstand

ANSI C62.41 (burst)

IEC 1999-4-2:ESD

IEC 1000-4-3:Radiated Immunity

IEC 1000-4-4:Fast Transient

IEC 1000-4-5:Surge Immunity

COMPLIANCE

ISO:manufactured to an ISO9001 registered program

UL:UL listed (file E250818)

CSA:Certified per: C22.2 No.1010.1 Electrical and Electronic
Measuring and Testing Equipment

CE:conforms to EN 55011 / EN 50082



EPM 6000 Multi-function Power Metering System

Chapter 2: Electrical Background

2.1 Three-Phase Power Measurement

2.1.1 Description

This introduction to three-phase power and power measurement is intended to provide only a brief overview of the subject. The professional meter engineer or meter technician should refer to more advanced documents such as the *EEI Handbook for Electricity Metering* and the application standards for more in-depth and technical coverage of the subject.

2.2 Three-Phase System Configurations

2.2.1 Description

Three-phase power is most commonly used in situations where large amounts of power will be used because it is a more effective way to transmit the power and because it provides a smoother delivery of power to the end load. There are two commonly used connections for three-phase power, a wye connection or a delta connection. Each connection has several different manifestations in actual use. When attempting to determine the type of connection in use, it is a good practice to follow the circuit back to the transformer that is serving the circuit. It is often not possible to conclusively determine the correct circuit connection simply by counting the wires in the service or checking voltages. Checking the transformer connection will provide conclusive evidence of the circuit connection and the relationships between the phase voltages and ground.

2.2.2 Wye Connection

The wye connection is so called because when you look at the phase relationships and the winding relationships between the phases it looks like a wye (Y). The following figure depicts the winding relationships for a wye-connected service. In a wye service the neutral (or center point of the wye) is typically grounded. This leads to common voltages of 208/120 and 480/277 (where the first number represents the phase-to-phase voltage and the second number represents the phase-to-ground voltage).

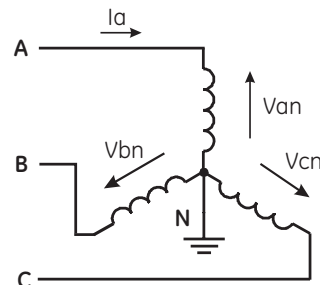

FIGURE 2-1: Three-Phase Wye Winding

The three voltages are electrically separated by 120° . Under balanced load conditions with unity power factor, the currents are also separated by 120° . However, unbalanced loads and other conditions can cause the currents to depart from the ideal 120° separation.

Three-phase voltages and currents are usually represented with a phasor diagram. A phasor diagram for the typical connected voltages and currents is shown below.

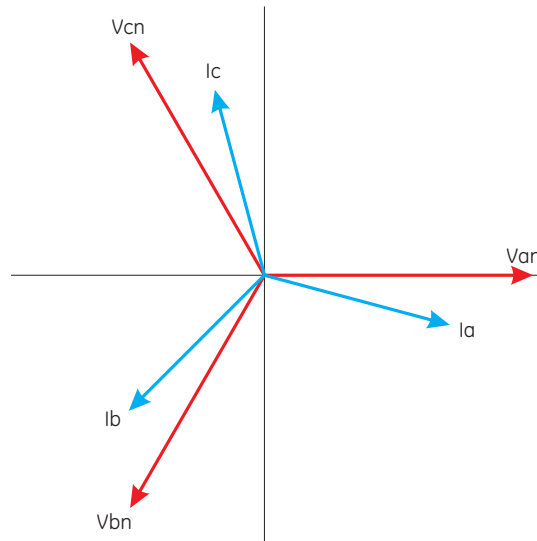

FIGURE 2-2: Three-Phase Voltage and Current Phasors for Wye Winding

The phasor diagram shows the 120° angular separation between the phase voltages. The phase-to-phase voltage in a balanced three-phase wye system is 1.732 times the phase-to-neutral voltage. The center point of the wye is tied together and is typically grounded. The following table indicates the common voltages used in the United States for wye-connected systems.

Table 2-1: Common Phase Voltages on Wye Services

Phase-to-Ground Voltage	Phase-to-Phase Voltage
120 volts	208 volts
277 volts	480 volts
2400 volts	4160 volts
7200 volts	12470 volts
7620 volts	13200 volts

Usually, a wye-connected service will have four wires: three wires for the phases and one for the neutral. The three-phase wires connect to the three phases. The neutral wire is typically tied to the ground or center point of the wye (refer to the *Three-Phase Wye Winding* diagram above).

In many industrial applications the facility will be fed with a four-wire wye service but only three wires will be run to individual loads. The load is then often referred to as a delta-connected load but the service to the facility is still a wye service; it contains four wires if you trace the circuit back to its source (usually a transformer). In this type of connection the phase to ground voltage will be the phase-to-ground voltage indicated in the table above, even though a neutral or ground wire is not physically present at the load. The transformer is the best place to determine the circuit connection type because this is a location where the voltage reference to ground can be conclusively identified.

2.2.3 Delta Connection

Delta connected services may be fed with either three wires or four wires. In a three-phase delta service the load windings are connected from phase-to-phase rather than from phase-to-ground. The following figure shows the physical load connections for a delta service.

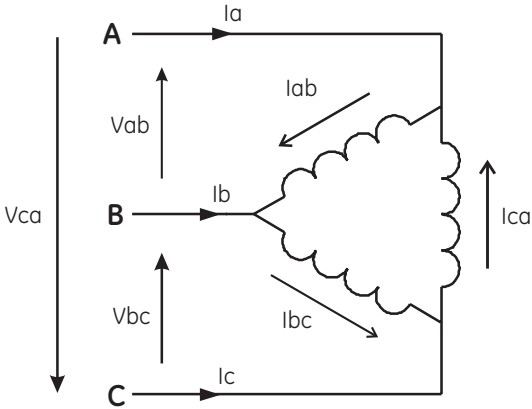

FIGURE 2-3: Three-Phase Delta Winding Relationship

In this example of a delta service, three wires will transmit the power to the load. In a true delta service, the phase-to-ground voltage will usually not be balanced because the ground is not at the center of the delta.

The following diagram shows the phasor relationships between voltage and current on a three-phase delta circuit.

In many delta services, one corner of the delta is grounded. This means the phase to ground voltage will be zero for one phase and will be full phase-to-phase voltage for the other two phases. This is done for protective purposes.

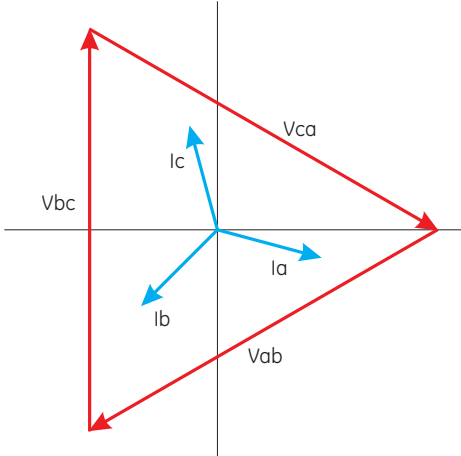

FIGURE 2-4: Three-Phase Voltage and Current Phasors for Delta Winding

Another common delta connection is the four-wire, grounded delta used for lighting loads. In this connection the center point of one winding is grounded. On a 120/240 volt, four-wire, grounded delta service the phase-to-ground voltage would be 120 volts on two phases and 208 volts on the third phase. The phasor diagram for the voltages in a three-phase, four-wire delta system is shown below.

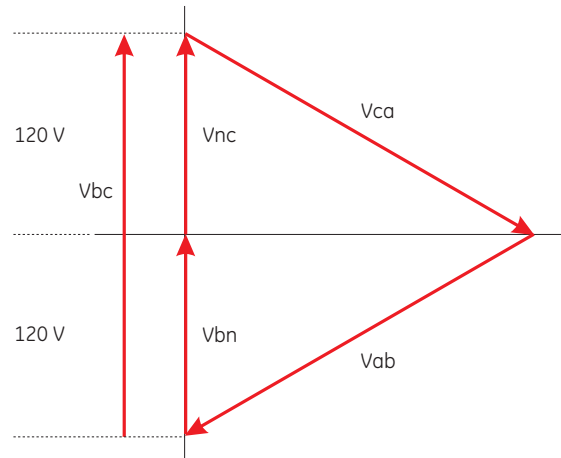

FIGURE 2-5: Three-Phase, Four-Wire Delta Phasors

2.2.4 Blondell's Theorem and Three-Phase Measurement

In 1893 an engineer and mathematician named Andre E. Blondell set forth the first scientific basis for poly phase metering. His theorem states:

If energy is supplied to any system of conductors through N wires, the total power in the system is given by the algebraic sum of the readings of N watt-meters so arranged that each of the N wires contains one current coil, the corresponding potential coil being connected between that wire and some common point. If this common point is on one of the N wires, the measurement may be made by the use of $N-1$ wattmeters.

The theorem may be stated more simply, in modern language:

In a system of N conductors, $N - 1$ meter elements will measure the power or energy taken provided that all the potential coils have a common tie to the conductor in which there is no current coil.

Three-phase power measurement is accomplished by measuring the three individual phases and adding them together to obtain the total three phase value. In older analog meters, this measurement was made using up to three separate elements. Each element combined the single-phase voltage and current to produce a torque on the meter disk. All three elements were arranged around the disk so that the disk was subjected to the combined torque of the three elements. As a result the disk would turn at a higher speed and register power supplied by each of the three wires.

According to Blondell's Theorem, it was possible to reduce the number of elements under certain conditions. For example, a three-phase, three-wire delta system could be correctly measured with two elements (two potential coils and two current coils) if the potential coils were connected between the three phases with one phase in common.

In a three-phase, four-wire wye system it is necessary to use three elements. Three voltage coils are connected between the three phases and the common neutral conductor. A current coil is required in each of the three phases.

In modern digital meters, Blondell's Theorem is still applied to obtain proper metering. The difference in modern meters is that the digital meter measures each phase voltage and current and calculates the single-phase power for each phase. The meter then sums the three phase powers to a single three-phase reading.

Some digital meters calculate the individual phase power values one phase at a time. This means the meter samples the voltage and current on one phase and calculates a power value. Then it samples the second phase and calculates the power for the second phase. Finally, it samples the third phase and calculates that phase power. After sampling all three phases, the meter combines the three readings to create the equivalent three-phase power value. Using mathematical averaging techniques, this method can derive a quite accurate measurement of three-phase power.

More advanced meters actually sample all three phases of voltage and current simultaneously and calculate the individual phase and three-phase power values. The advantage of simultaneous sampling is the reduction of error introduced due to the difference in time when the samples were taken.

Blondell's Theorem is a derivation that results from Kirchhoff's Law. Kirchhoff's Law states that the sum of the currents into a node is zero. Another way of stating the same thing is that the current into a node (connection point) must equal the current out of the node. The law can be applied to measuring three-phase loads. The figure below shows a typical connection of a three-phase load applied to a three-phase, four-wire service. Kirchhoff's Laws hold that the sum of currents A, B, C and N must equal zero or that the sum of currents into Node "n" must equal zero.

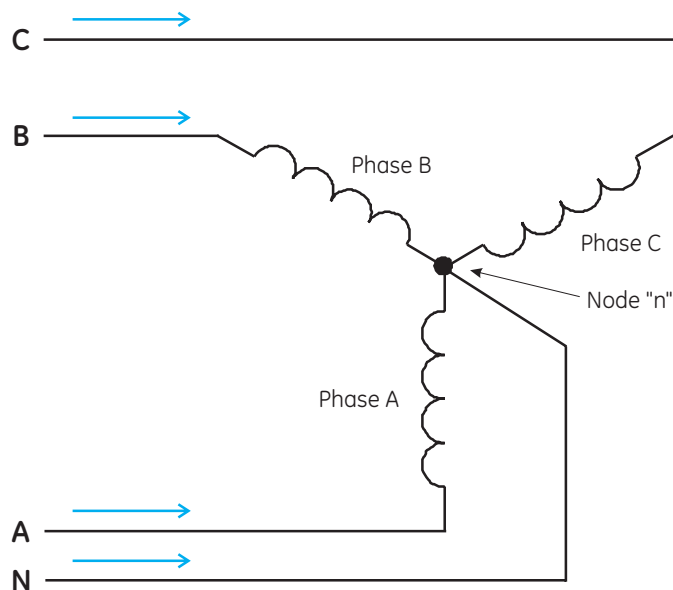

FIGURE 2-6: Three-Phase Load Illustrating Kirchhoff's Law and Blondell's Theorem

If we measure the currents in wires A, B and C, we then know the current in wire N by Kirchhoff's Law and it is not necessary to measure it. This fact leads us to the conclusion of Blondell's Theorem that we only need to measure the power in three of the four wires if they are connected by a common node. In the circuit of Figure 1.6 we must measure the power flow in three wires. This will require three voltage coils and three current coils (a three element meter). Similar figures and conclusions could be reached for other circuit configurations involving delta-connected loads.

2.3 Power, Energy, and Demand

2.3.1 Description

It is quite common to exchange power, energy, and demand without differentiating between the three. Because this practice can lead to confusion, the differences between these three measurements will be discussed.

2.3.2 Power

Power is an instantaneous reading. The power reading provided by a meter is the present flow of watts. Power is measured immediately just like current. In many digital meters, the power value is actually measured and calculated over a one-second interval, since it takes some amount of time to calculate the RMS values of voltage and current. However, this time interval is kept small to preserve the instantaneous nature of power.

2.3.3 Energy

Energy is always based upon some time increment – it is the integration of power over a defined time increment. Energy is an important value because almost all electric bills are based, in part, on the amount of energy consumed.

Typically, electrical energy is measured in units of kilowatt-hours (kWh). A kilowatt-hour represents a constant load of 1000 watts (1 kW) for 1 hour. Stated another way, if the power delivered (instantaneous watts) is measured as 1000 W, and the load was served for a one-hour time interval, then the load would have absorbed 1 kWh of energy. A different load may have a constant power requirement of 4000 W. If this load were served for one hour, it would absorb 4 kWh of energy. Likewise, if it were served for 15 minutes, it would absorb $\frac{1}{4}$ of that total, or 1 kWh.

The following figure shows a graph of power and the resulting energy that would be transmitted as a result of the illustrated power values. For this illustration, it is assumed that the power level is held constant for each minute when a measurement is taken. Each bar in the graph represents the power load for the one-minute increment of time. In real life, the power values are continually moving.

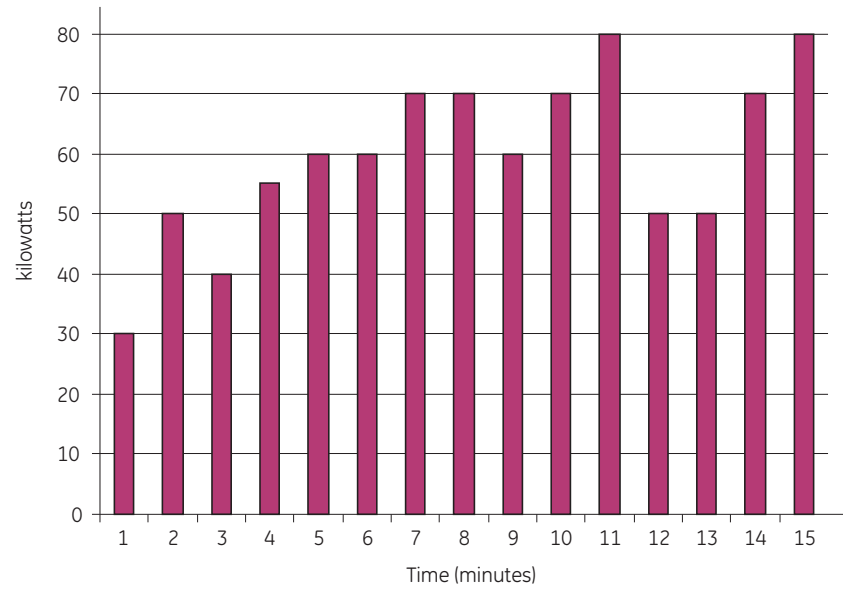
**FIGURE 2-7: Power Use Over Time**

The data in the above figure is reproduced in the following table to illustrate the calculation of energy. Since the time increment of the measurement is one minute, and since we specified a constant load over that minute, the power reading can be converted to an equivalent consumed energy reading by multiplying the power reading by 1/60 (converting the time base from minutes to hours).

Table 2–2: Power and Energy Relationship Over Time

Time Interval	Power	Energy	Accumulated Energy
1 minute	30 kW	0.50 kWh	0.50 kWh
2 minutes	50 kW	0.83 kWh	1.33 kWh
3 minutes	40 kW	0.67 kWh	2.00 kWh
4 minutes	55 kW	0.92 kWh	2.92 kWh
5 minutes	60 kW	1.00 kWh	3.92 kWh
6 minutes	60 kW	1.00 kWh	4.92 kWh
7 minutes	70 kW	1.17 kWh	6.09 kWh
8 minutes	70 kW	1.17 kWh	7.26 kWh
9 minutes	60 kW	1.00 kWh	8.26 kWh
10 minutes	70 kW	1.17 kWh	9.43 kWh
11 minutes	80 kW	1.33 kWh	10.76 kWh
12 minutes	50 kW	0.83 kWh	12.42 kWh
13 minutes	50 kW	0.83 kWh	12.42 kWh
14 minutes	70 kW	1.17 kWh	13.59 kWh
15 minutes	80 kW	1.33 kWh	14.92 kWh

As shown in the above table, the accumulated energy for the power load profile of the data in *Power Use Over Time* on page 2–9 is 14.92 kWh.

2.3.4 Demand

Demand is also a time-based value. The demand is the average rate of energy use over time. The actual label for demand is kilowatt-hours/hour but this is normally reduced to kilowatts. This makes it easy to confuse demand with power. But demand is not an instantaneous value. To calculate demand it is necessary to accumulate the energy readings (as illustrated in *Power Use Over Time* on page 2–9) and adjust the energy reading to an hourly value that constitutes the demand.

In the example, the accumulated energy is 14.92 kWh. But this measurement was made over a 15-minute interval. To convert the reading to a demand value, it must be normalized to a 60-minute interval. If the pattern were repeated for an additional three 15-minute intervals the total energy would be four times the measured value or 59.68 kWh. The same process is applied to calculate the 15-minute demand value. The demand value associated with the example load is 59.68 kWh/hour or 59.68 kWd. Note that the peak instantaneous value of power is 80 kW, significantly more than the demand value.

The following figure illustrates another example of energy and demand. In this case, each bar represents the energy consumed in a 15-minute interval. The energy use in each interval typically falls between 50 and 70 kWh. However, during two intervals the energy rises sharply and peaks at 100 kWh in interval #7. This peak of usage will result in setting a high demand reading. For each interval shown the demand value would be four times the indicated energy reading. So interval 1 would have an associated demand of 240 kWh/hr. Interval #7 will have a demand value of 400 kWh/hr. In the data shown, this is the peak demand value and would be the number that would set the demand charge on the utility bill.

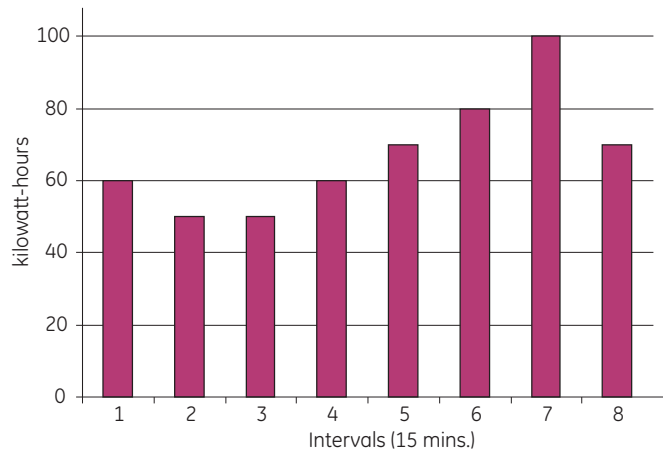

FIGURE 2-8: Energy Use and Demand Intervals

As seen in this example, it is important to recognize the relationships between power, energy and demand in order to effectively control loads or to correctly monitor use.

2.4 Reactive Energy and Power Factor

2.4.1 Real, Reactive, and Apparent Power

The real power and energy measurements discussed in the previous section relate to the quantities that are most used in electrical systems. But it is often not sufficient to only measure real power and energy. Reactive power is a critical component of the total power picture because almost all real-life applications have an impact on reactive power. Reactive power and power factor concepts relate to both load and generation applications. However, this discussion will be limited to analysis of reactive power and power factor as they relate to loads. To simplify the discussion, generation will not be considered.

Real power (and energy) is the component of power that is the combination of the voltage and the value of corresponding current that is directly in phase with the voltage. However, in actual practice the total current is almost never in phase with the voltage. Since the current is not in phase with the voltage, it is necessary to consider both the in-phase component and the component that is at quadrature (angularly rotated 90° or perpendicular) to the voltage. The following figure shows a single-phase voltage and current and breaks the current into its in-phase and quadrature components.

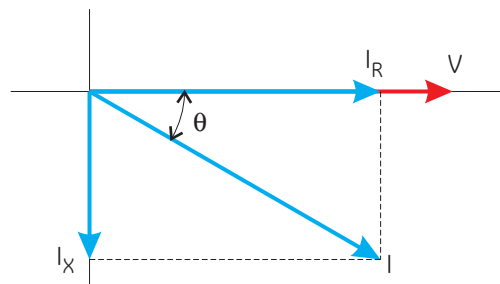

FIGURE 2-9: Voltage and Complex Current

The voltage (V) and the total current (I) can be combined to calculate the apparent power or VA. The voltage and the in-phase current (I_R) are combined to produce the real power or watts. The voltage and the quadrature current (I_X) are combined to calculate the reactive power.

The quadrature current may be lagging the voltage (as shown above) or it may lead the voltage. When the quadrature current lags the voltage the load is requiring both real power (watts) and reactive power (vars). When the quadrature current leads the voltage the load is requiring real power (watts) but is delivering reactive power (vars) back into the system; that is VARs are flowing in the opposite direction of the real power flow.

Reactive power (vars) is required in all power systems. Any equipment that uses magnetization to operate requires vars. Usually the magnitude of vars is relatively low compared to the real power quantities. Utilities have an interest in maintaining VAR requirements at the customer to a low value in order to maximize the return on plant invested to deliver energy. When lines are carrying vars, they cannot carry as many watts.

So keeping the var content low allows a line to carry its full capacity of watts. In order to encourage customers to keep VAR requirements low, most utilities impose a penalty if the var content of the load rises above a specified value.

2.4.2 Power Factor

A common method of measuring reactive power requirements is power factor. Power factor can be defined in two different ways. The more common method of calculating power factor is the ratio of the real power to the apparent power. This relationship is expressed in the following formula:

$$\text{Total PF} = \frac{\text{real power}}{\text{apparent power}} = \frac{\text{watts}}{\text{VA}} \quad \text{(EQ 2.1)}$$

This formula calculates a power factor quantity known as Total Power Factor. It is called Total PF because it is based on the ratios of the power delivered. The delivered power quantities will include the impacts of any existing harmonic content. If the voltage or current includes high levels of harmonic distortion the power values will be affected. By calculating power factor from the power values, the power factor will include the impact of harmonic distortion. In many cases this is the preferred method of calculation because the entire impact of the actual voltage and current are included.

A second type of power factor is Displacement Power Factor. Displacement PF is based on the angular relationship between the voltage and current. Displacement power factor does not consider the magnitudes of voltage, current or power. It is solely based on the phase angle differences. As a result, it does not include the impact of harmonic distortion. Displacement power factor is calculated using the following equation:

$$\text{Displacement PF} = \cos \theta \quad \text{(EQ 2.2)}$$

where θ is the angle between the voltage and the current (see FIGURE 2-9: *Voltage and Complex Current* on page 2-12).

In applications where the voltage and current are not distorted, the Total Power Factor will equal the Displacement Power Factor. But if harmonic distortion is present, the two power factors will not be equal.

2.5 Harmonic Distortion

2.5.1 Harmonics of a Non-Sinusoidal Waveform

Harmonic distortion is primarily the result of high concentrations of non-linear loads. Devices such as computer power supplies, variable speed drives and fluorescent light ballasts make current demands that do not match the sinusoidal waveform of AC electricity. As a result, the current waveform feeding these loads is periodic but not sinusoidal. The following figure shows a normal, sinusoidal current waveform with a period of a . This example has no distortion.

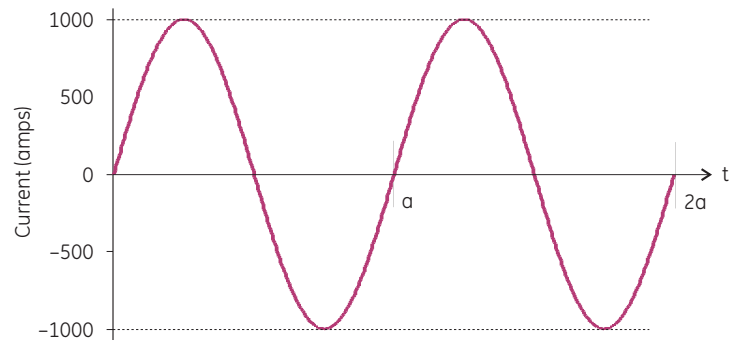

FIGURE 2-10: Non-Distorted Current Waveform

The figure below shows a current waveform with a slight amount of harmonic distortion. The waveform is still periodic and is fluctuating at the normal 60 Hz frequency ($a = 1/60$ second). However, the waveform is not the smooth sinusoidal form seen above.

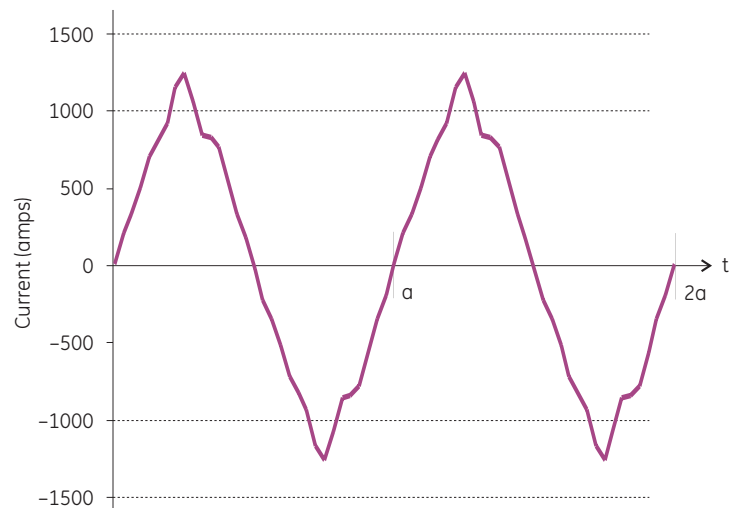

FIGURE 2-11: Distorted Current Waveform

The distortion above can be modeled as the sum of several sinusoidal waveforms of frequencies that are multiples of the fundamental 60 Hz frequency. This modeling is performed by mathematically reducing the distorted waveform into a collection of higher

frequency waveforms. These higher frequency waveforms are referred to as harmonics. The following figure shows the content of the harmonic frequencies that comprise one cycle of the distorted portion of the above waveform.

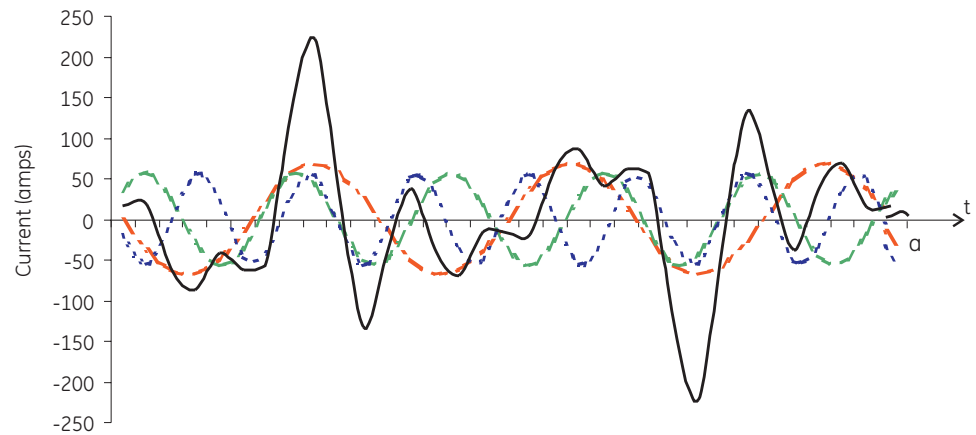

FIGURE 2-12: Harmonics for Distorted Current Waveform

The waveforms above provide an indication of the impact of combining multiple harmonic frequencies together. The broken lines represent the 3rd, 5th, and 7th current harmonics. The solid line represents the sum of the three harmonics.

When harmonics are present, it is important to remember that they are operating at higher frequencies. As such, they do not always respond in the same manner as 60 Hz values.

2.5.2 Inductive and Capacitive Impedance

Inductive and capacitive impedance are present in all power systems. We are accustomed to thinking about these impedances as they perform at 60 Hz. However, these impedances are subject to frequency variation.

$$X_L = j\omega L \quad \text{and} \quad X_C = 1/j\omega C \quad (\text{EQ 2.3})$$

At 60 Hz, $\omega = 377$; but at 300 Hz (5th harmonic) $\omega = 1885$. As frequency changes, the impedance changes and system impedance characteristics that are normal at 60 Hz may be entirely different in the presence of higher order harmonic waves.

Traditionally, the most common harmonics have been the low order odd frequencies, such as the 3rd, 5th, 7th, and 9th. However newer, non-linear loads are introducing significant quantities of higher order harmonics.

2.5.3 Voltage and Current Monitoring

Since much voltage monitoring and almost all current monitoring is performed using instrument transformers, the higher order harmonics are often not visible. Instrument transformers are designed to pass 60 Hz quantities with high accuracy. These devices, when designed for accuracy at low frequency, do not pass high frequencies with high

accuracy; at frequencies above about 1200 Hz they pass almost no information. So when instrument transformers are used, they effectively filter out higher frequency harmonic distortion making it impossible to see.

However, when monitors can be connected directly to the measured circuit (such as direct connection to 480 V bus) the user may often see higher order harmonic distortion. An important rule in any harmonics study is to evaluate the type of equipment and connections before drawing a conclusion. Not being able to see harmonic distortion is not the same as not having harmonic distortion.

2.5.4 Waveform Capture

It is common in advanced meters to perform a function commonly referred to as waveform capture. Waveform capture is the ability of a meter to capture a present picture of the voltage or current waveform for viewing and harmonic analysis. Typically a waveform capture will be one or two cycles in duration and can be viewed as the actual waveform, as a spectral view of the harmonic content, or a tabular view showing the magnitude and phase shift of each harmonic value. Data collected with waveform capture is typically not saved to memory. Waveform capture is a real-time data collection event.

Waveform capture should not be confused with waveform recording that is used to record multiple cycles of all voltage and current waveforms in response to a transient condition.

2.6 Power Quality

2.6.1 Description

Power quality can mean several different things. The terms *power quality* and *power quality problem* have been applied to all types of conditions. A simple definition of *power quality problem* is any voltage, current or frequency deviation that results in misoperation or failure of customer equipment or systems. The causes of power quality problems vary widely and may originate in the customer equipment, in an adjacent customer facility or with the utility.

In his book *Power Quality Primer*, Barry Kennedy provided information on different types of power quality problems. Some of that information is summarized in the following table.

Table 2-3: Typical Power Quality Problems

Cause	Disturbance Type	Source(s)
Impulse transient	Transient voltage disturbance, sub-cycle duration	Lightning; Electrostatic discharge; Load switching; Capacitor switching
Oscillatory transient with decay	Transient voltage, sub-cycle duration	Line/cable switching; Capacitor switching; Load switching
Sag/swell	RMS voltage, multiple cycle duration	Remote system faults
Interruptions	RMS voltage, multiple second or longer duration	System protection; Circuit breakers; Fuses; Maintenance
Undervoltage/ Overvoltage	RMS voltage, steady state, multiple second or longer duration	Motor starting; Load variations; Load dropping
Voltage flicker	RMS voltage, steady state, repetitive condition	Intermittent loads; Motor starting; Arc furnaces
Harmonic distortion	Steady-state current or voltage, long term duration	Non-linear loads; System resonance

It is often assumed that power quality problems originate with the utility. While it is true that many power quality problems can originate with the utility system, many problems originate with customer equipment. Customer-caused problems may manifest themselves inside the customer location or they may be transported by the utility system to another adjacent customer. Often, equipment that is sensitive to power quality problems may in fact also be the cause of the problem.

If a power quality problem is suspected, it is generally wise to consult a power quality professional for assistance in defining the cause and possible solutions to the problem.



EPM 6000 Multi-function Power Metering System

Chapter 3: Installation

3.1 Mechanical Installation

3.1.1 Dimensions

The EPM 6000 meter can be installed using a standard ANSI C39.1 (4" round) or an IEC 92 mm DIN (square) form. In new installations, simply use existing DIN or ANSI punches. For existing panels, pull out old analog meters and replace with the EPM 6000. The various models use the same installation. See *Wiring Diagrams* on page 3–9 for various Wye and Delta wiring diagrams.

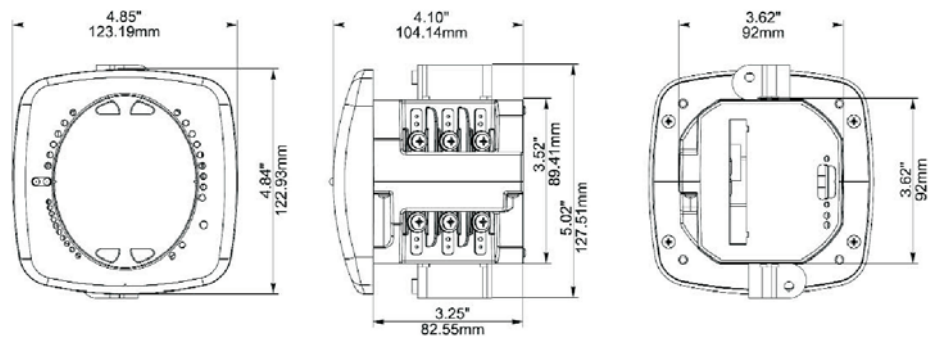

FIGURE 3–1: Bezel, Side, and Back Dimensions

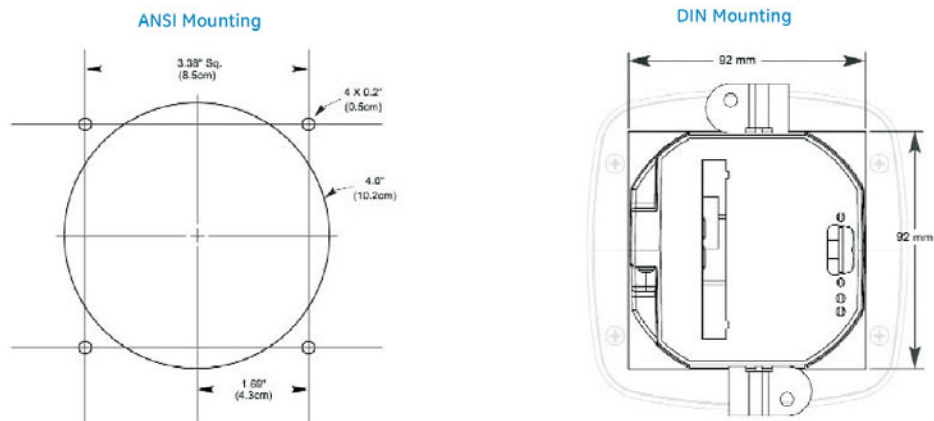

FIGURE 3-2: ANSI and DIN Mounting Panel Cutouts

3.1.2 ANSI Installation Steps

Mount the meter in a dry location free from dirt and corrosive substances. The meter is designed to withstand harsh environmental conditions (see the *Environmental* specifications in Chapter 2 for additional details).

Use the following steps to install the meter:

- ▷ Insert the four threaded rods by hand into the back of the meter. Twist until secure.
- ▷ Slide the ANSI 12 mounting gasket onto the back of the meter with the rods in place.
- ▷ Slide the meter with the mounting gasket into the panel.
- ▷ Secure from the back of the panel with a lock washer and nut on each threaded rod. Use a small wrench to tighten – do not overtighten.

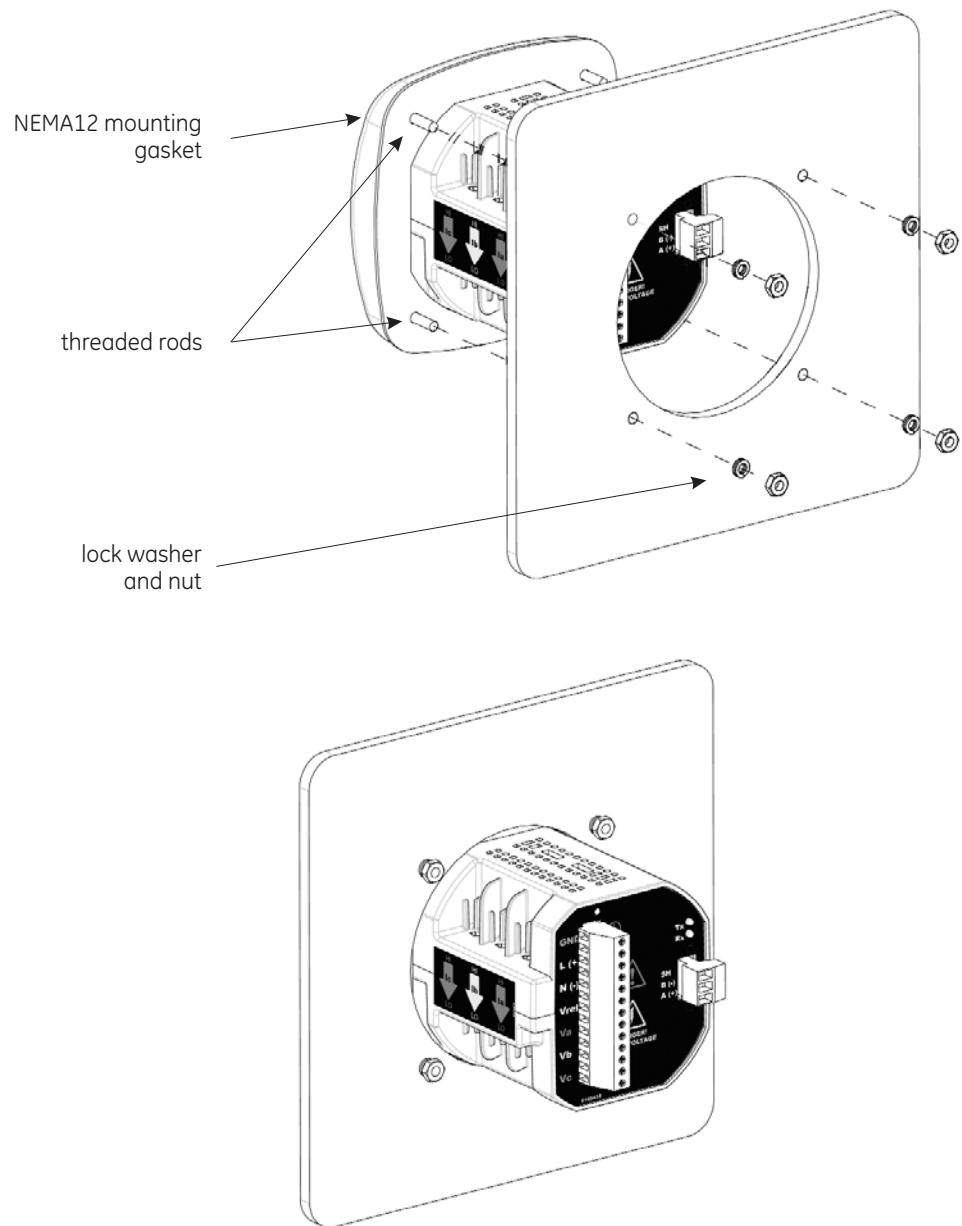

FIGURE 3-3: ANSI Mounting Procedure

3.1.3 DIN Installation Steps

Mount the meter in a dry location free from dirt and corrosive substances. The meter is designed to withstand harsh environmental conditions (see the *Environmental* specifications in Chapter 2 for additional details).

Use the following steps to install the meter:

- ▷ Slide the meter with NEMA 12 mounting gasket into panel.

- ▷ From back of the panel, slide 2 DIN mounting brackets into the grooves on the top and bottom of the meter housing, then snap into place.
 - ▷ Secure meter to panel with a lock washer and #8 screw through each of the two mounting brackets.
- Tighten with a #2 Phillips screwdriver – do not overtighten.

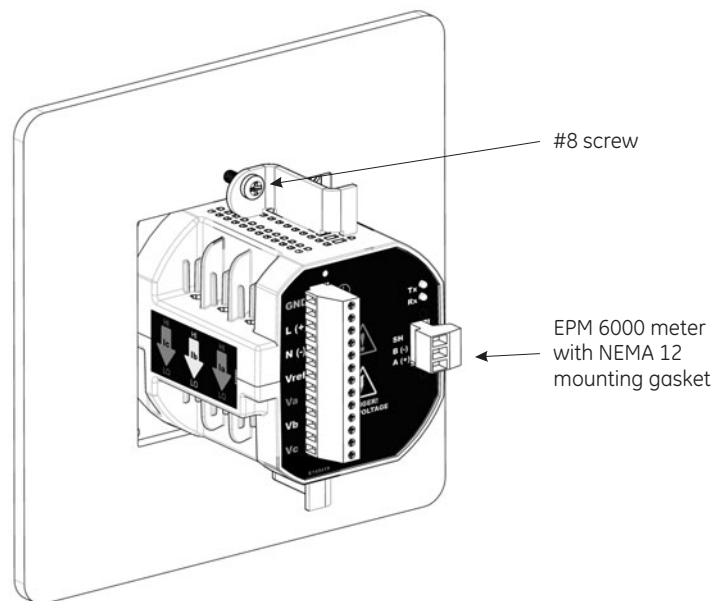
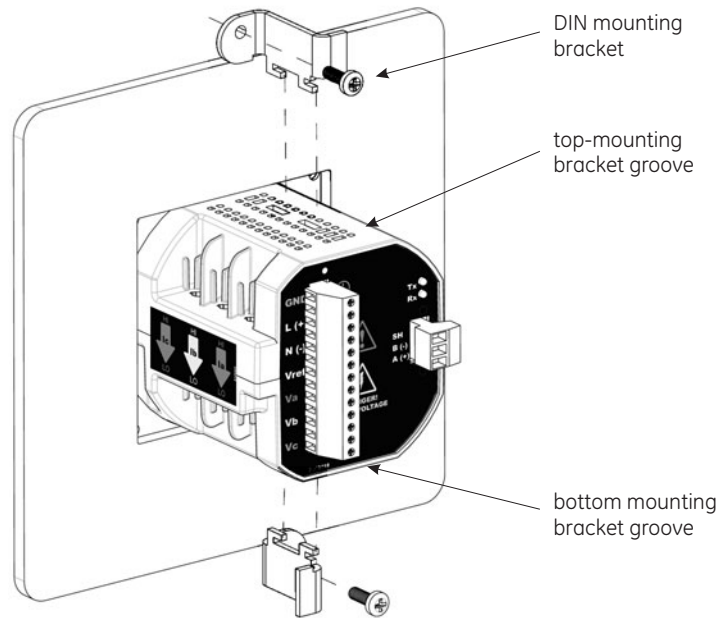

FIGURE 3-4: DIN Mounting Procedure

3.2 Electrical Installation

3.2.1 Installation Considerations

Installation of the EPM 6000 Power Metering System must be performed by only qualified personnel who follow standard safety precautions during all procedures. Those personnel should have appropriate training and experience with high voltage devices. Appropriate safety gloves, safety glasses and protective clothing is recommended.

During normal operation of the EPM 6000, dangerous voltages flow through many parts of the meter, including: Terminals and any connected CTs (current transformers) and PTs (potential transformers), all input/output modules and their circuits. All primary and secondary circuits can, at times, produce lethal voltages and currents. Avoid contact with any current-carrying surfaces.

Do not use the meter or any I/O output device for primary protection or in an energy-limiting capacity. The meter can only be used as secondary protection. Do not use the meter for applications where failure of the meter may cause harm or death. Do not use the meter for any application where there may be a risk of fire.

All meter terminals should be inaccessible after installation.

Do not apply more than the maximum voltage the meter or any attached device can withstand. Refer to meter and/or device labels and to the *Specifications* for all devices before applying voltages. Do not hi-pot/dielectric test any outputs, inputs or communications terminals.

GE recommends the use of shorting blocks and fuses for voltage leads and power supply to prevent hazardous voltage conditions or damage to CTs, if the meter needs to be removed from service. **CT grounding is optional.**



If the equipment is used in a manner not specified by the manufacturer, the protection provided by the equipment may be impaired.



There is no required preventive maintenance or inspection necessary for safety. however, any repair or maintenance should be performed by the factory.



DISCONNECT DEVICE: The following part is considered the equipment disconnect device.

A switch or circuit-breaker must be included in the end-use equipment or building installation. The switch shall be in close proximity to the equipment and within easy reach of the operator. The switch shall be marked as the disconnecting device for the equipment.

3.2.2 CT Leads Terminated to Meter

The EPM 6000 is designed to have current inputs wired in one of three ways. The figure below shows the most typical connection, where CT Leads are terminated to the meter at the current gills. This connection uses nickel-plated brass studs (current gills) with screws at each end. This connection allows the CT wires to be terminated using either an “O” or a “U” lug. Tighten the screws with a #2 Phillips screwdriver.

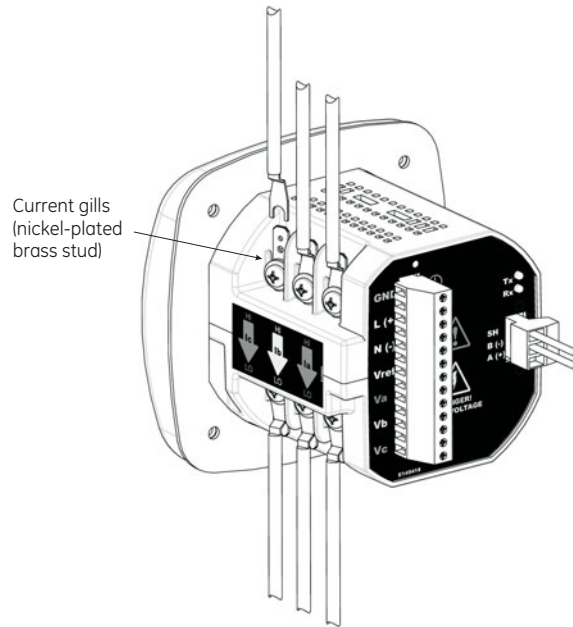

FIGURE 3-5: CT Leads Terminated to Meter

Wiring diagrams are detailed in *Wiring Diagrams* on page 3-9. Communications connections are detailed in *Communications Setup* on page 3-19.

3.2.3 CT Leads Pass-Through (No Meter Termination)

The second method allows the CT wires to pass through the CT Inputs without terminating at the meter. In this case, remove the current gills and place the CT wire directly through the CT opening. The opening will accommodate up to 0.177" / 4.5 mm maximum diameter CT wire.

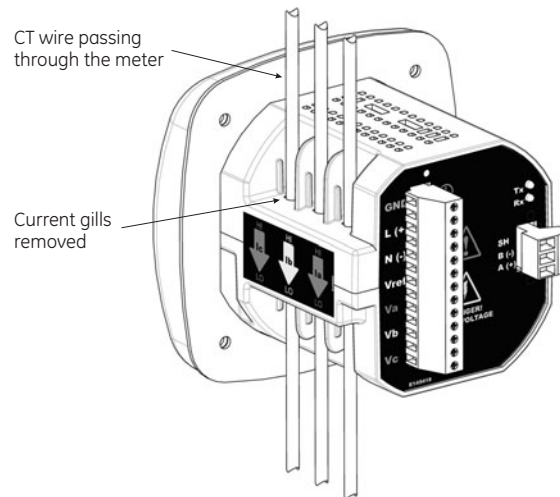

FIGURE 3-6: Pass-Through Wire Electrical Connection

3.2.4 Quick Connect Crimp CT Terminations

For quick termination or for portable applications, a quick connect crimp CT connection can also be used.

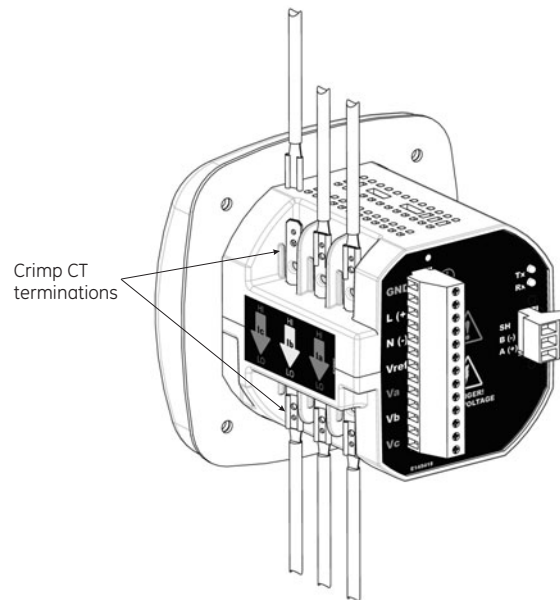

FIGURE 3-7: Quick Connect Electrical Connection

3.2.5 Voltage and Power Supply Connections

Voltage Inputs are connected to the back of the unit via a optional wire connectors. The connectors accommodate up to AWG#12 / 2.5 mm wire.

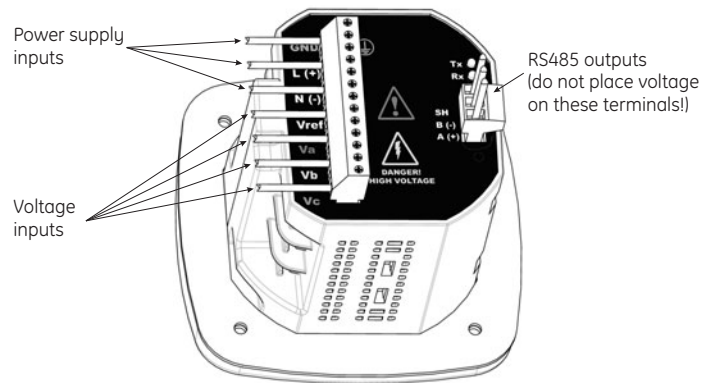

FIGURE 3-8: Voltage Connection

3.2.6 Ground Connections

The EPM 6000 ground terminals (⏚) should be connected directly to the installation's protective earth ground. Use 2.5 mm wire for this connection.



GE recommends the use of fuses on each of the sense voltages and on the control power, even though the wiring diagrams in this chapter do not show them.

- Use a 0.1 A fuse on each voltage input.
- Use a 3 A fuse on the power supply.

3.3 Wiring Diagrams

3.3.1 Description

Choose the diagram that best suits your application and maintains the CT polarity.

1. Three-phase, four-wire system Wye with direct voltage, 3 element.
2. Three-phase, four-wire system Wye with direct voltage, 2.5 element.
3. Three-phase, four-wire Wye with PTs, 3 element.
4. Three-phase, four-wire Wye with PTs, 2.5 element.
5. Three-phase, three-wire Delta with direct voltage.
6. Three-phase, three-wire Delta with PTs.
7. Current-only measurement (three-phase).
8. Current-only measurement (dual-phase).
9. Current-only measurement (single-phase).

These diagrams are indicated in the sections following.

3.3.2 Wye, 4-Wire with no PTs and 3 CTs, 3 Element

For this wiring type, select 3 **EL WYE** (3-element Wye) in the meter programming setup.

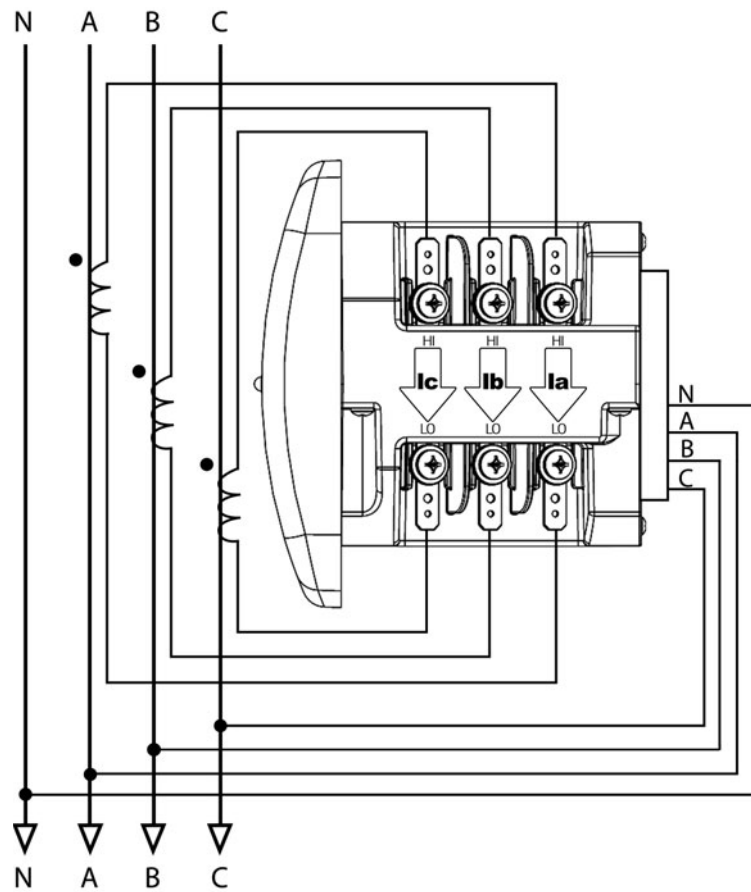

FIGURE 3-9: 4-Wire Wye with no PTs and 3 CTs, 3 Element

3.3.3 Wye, 4-Wire with no PTs and 3 CTs, 2.5 Element

For this wiring type, select **2.5EL WYE** (2.5-element Wye) in the meter programming setup.

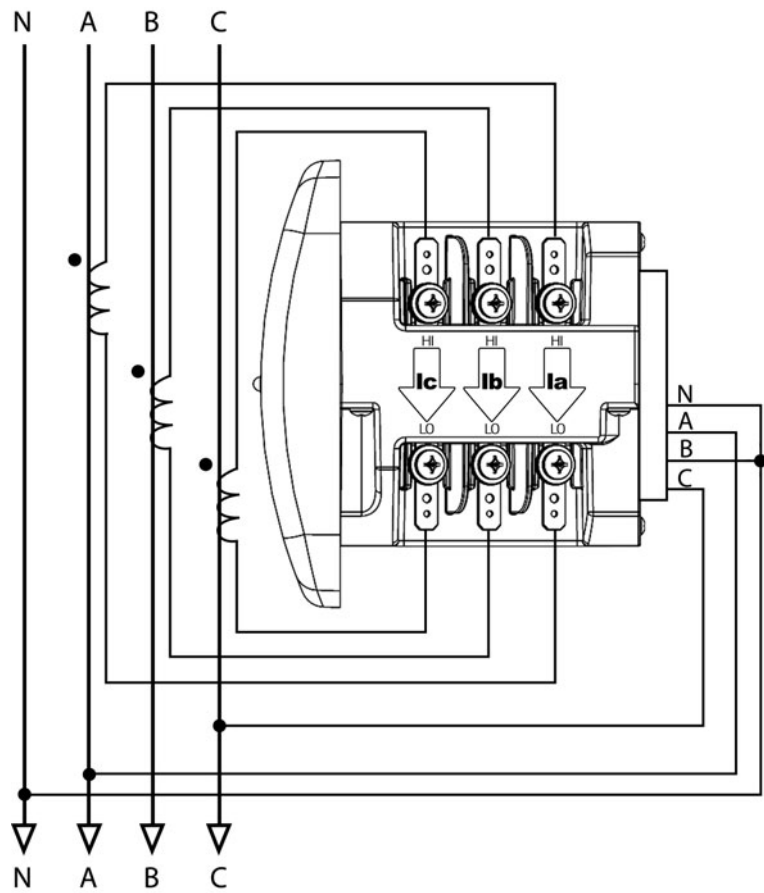

FIGURE 3-10: 4-Wire Wye with no PTs and 3 CTs, 2.5 Element

3.3.4 Wye, 4-Wire with 3 PTs and 3 CTs, 3 Element

For this wiring type, select 3 **EL WYE** (3-element Wye) in the meter programming setup.

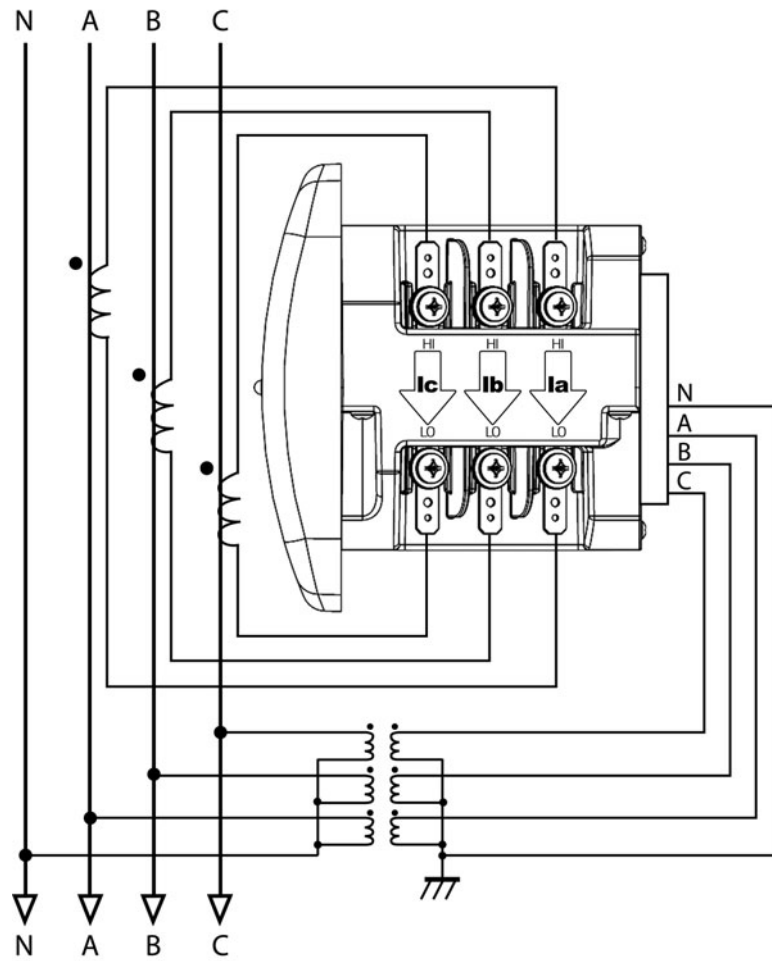

FIGURE 3-11: 4-Wire Wye with 3 PTs and 3 CTs, 3 Element

3.3.5 Wye, 4-Wire with 2 PTs and 3 CTs, 2.5 Element

For this wiring type, select **2.5EL WYE** (2.5-element Wye) in the meter programming setup.

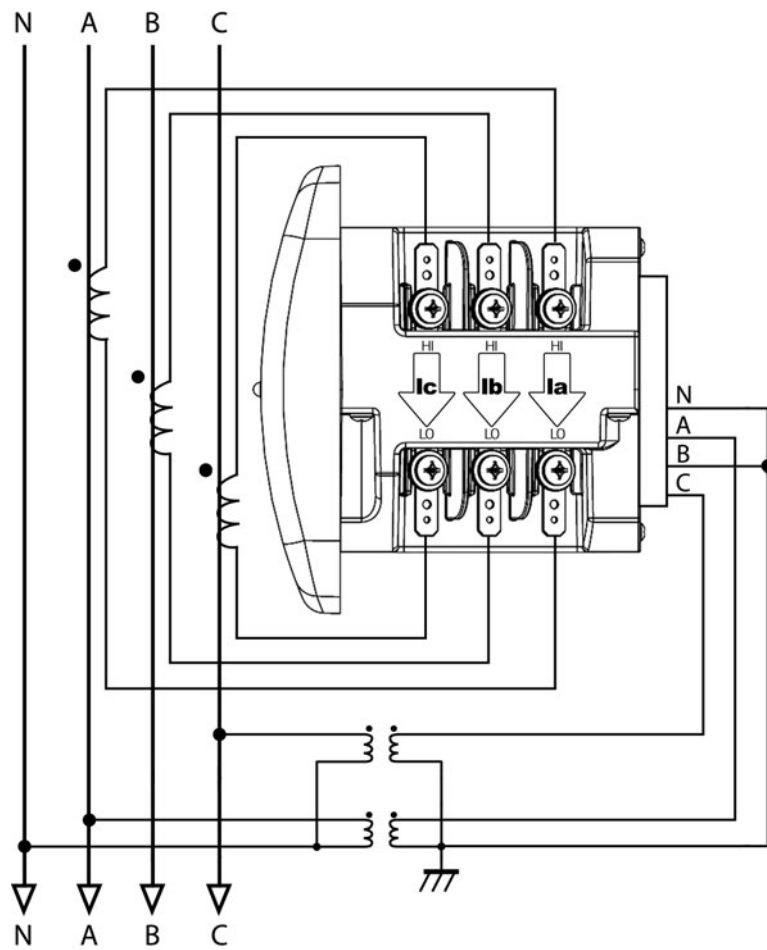

FIGURE 3-12: 4-Wire Wye with 2 PTs and 3 CTs, 2.5 Element

3.3.6 Delta, 3-Wire with no PTs and 2 CTs

For this wiring type, select **2 ct DEL** (2 CT Delta) in the meter programming setup.

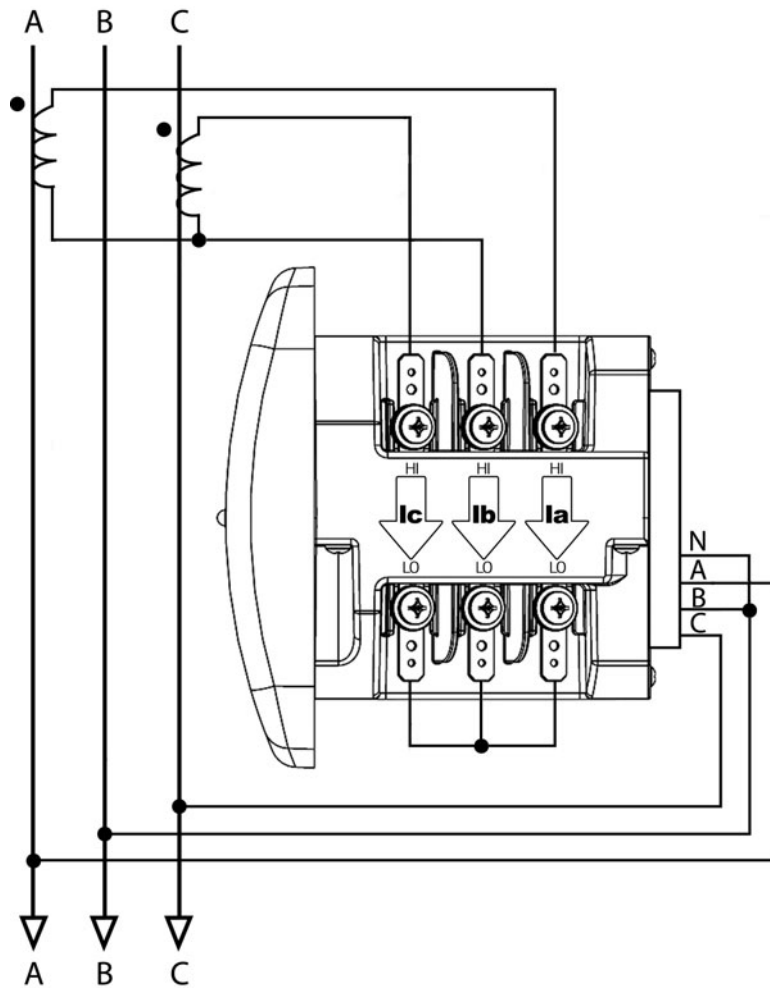

FIGURE 3-13: 3-Wire Delta with no PTs and 2 CTs

3.3.7 Delta, 3-Wire with 2 PTs and 2 CTs

For this wiring type, select 2 ct DEL (2 CT Delta) in the meter programming setup.

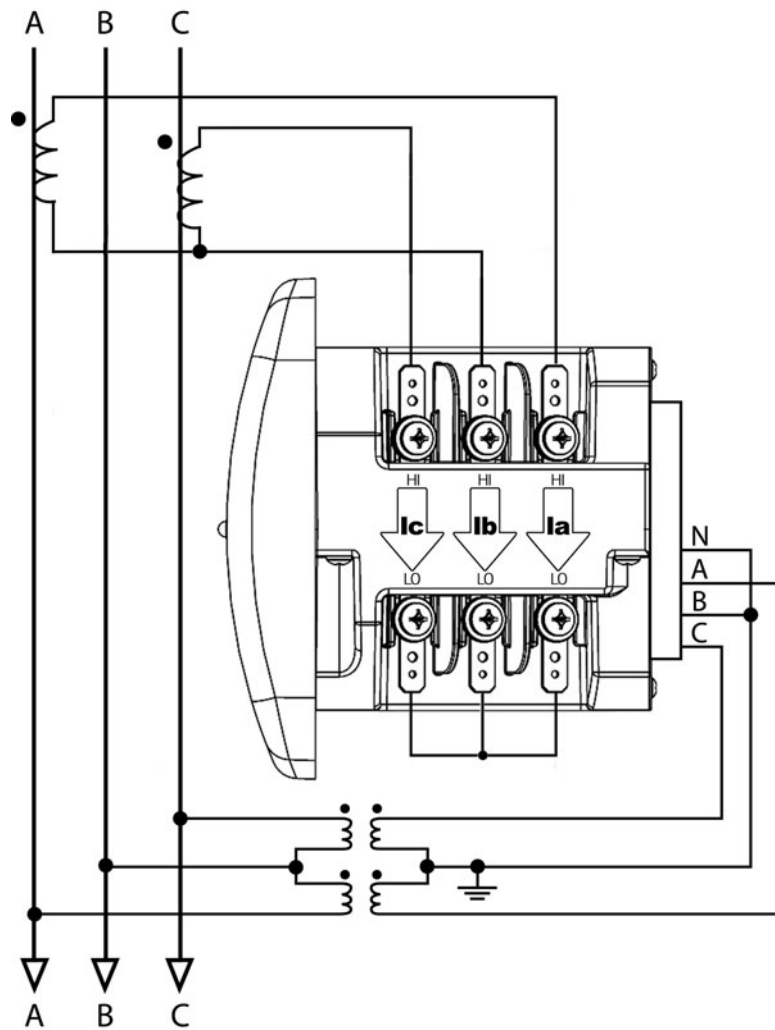
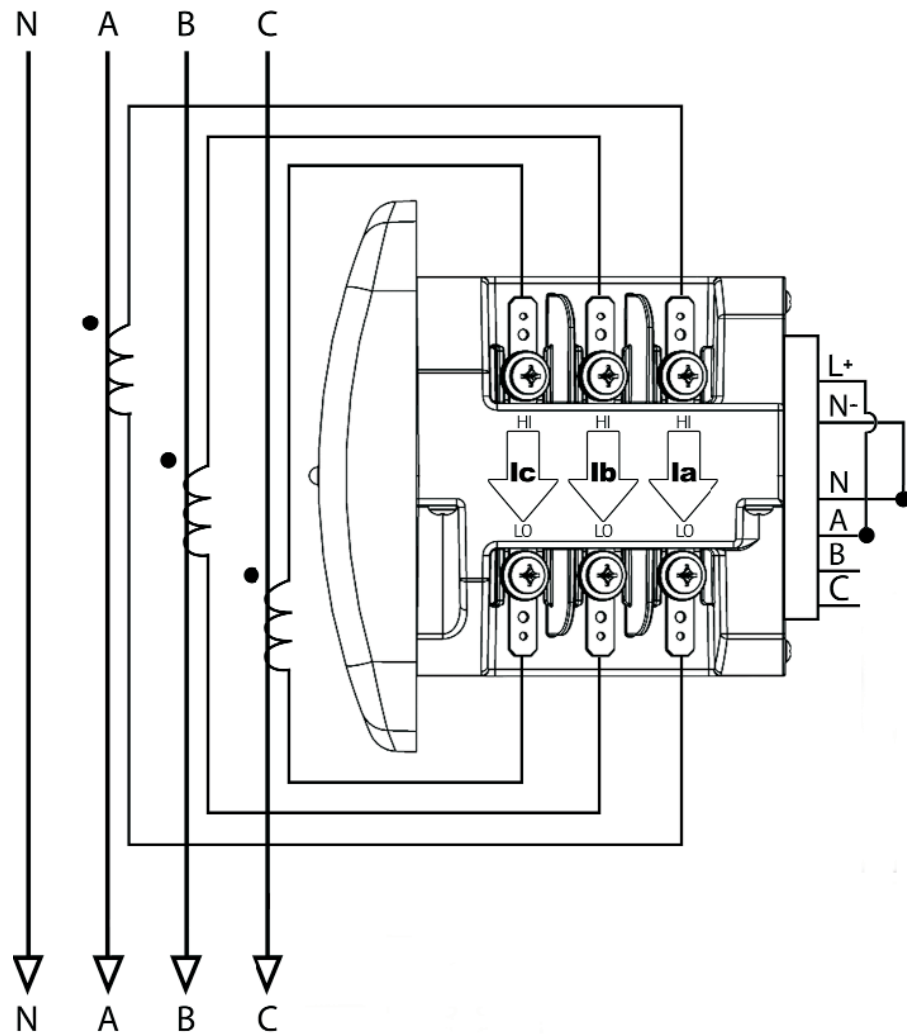

FIGURE 3-14: 3-Wire Delta with 2 PTs and 2 CTs

3.3.8 Current-Only Measurement (Three-Phase)

For this wiring type, select **3 EL WYE** (3 Element Wye) in the meter programming setup.



Even if the meter is used only for current measurement, the unit requires a AN volts reference. Please ensure that the voltage input is attached to the meter. AC control power can be used to provide the reference signal.

3.3.9 Current-Only Measurement (Dual-Phase)

For this wiring type, select **3 EL WYE** (3 Element Wye) in the meter programming setup.

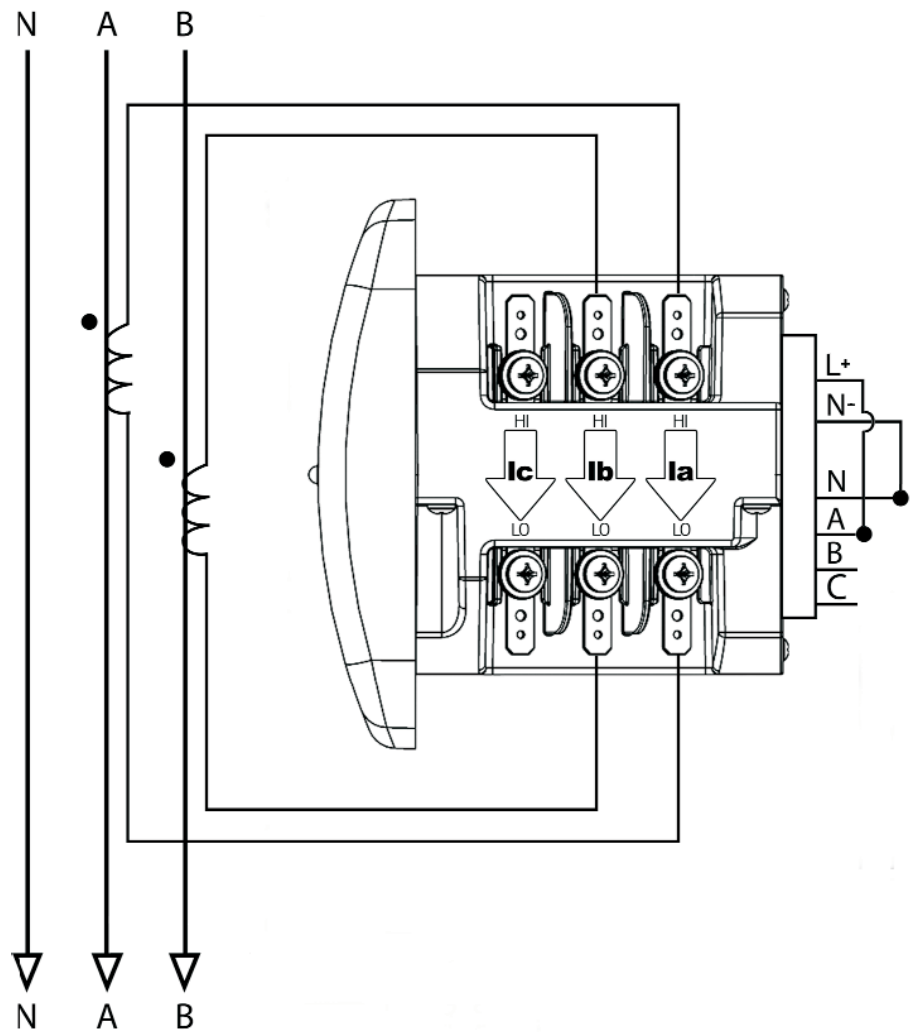

NOTE

Even if the meter is used only for current measurement, the unit requires a AN volts reference. Please ensure that the voltage input is attached to the meter. AC control power can be used to provide the reference signal.

3.3.10 Current-Only Measurement (Single-Phase)

For this wiring type, select **3 EL WYE** (3 Element Wye) in the meter programming setup.

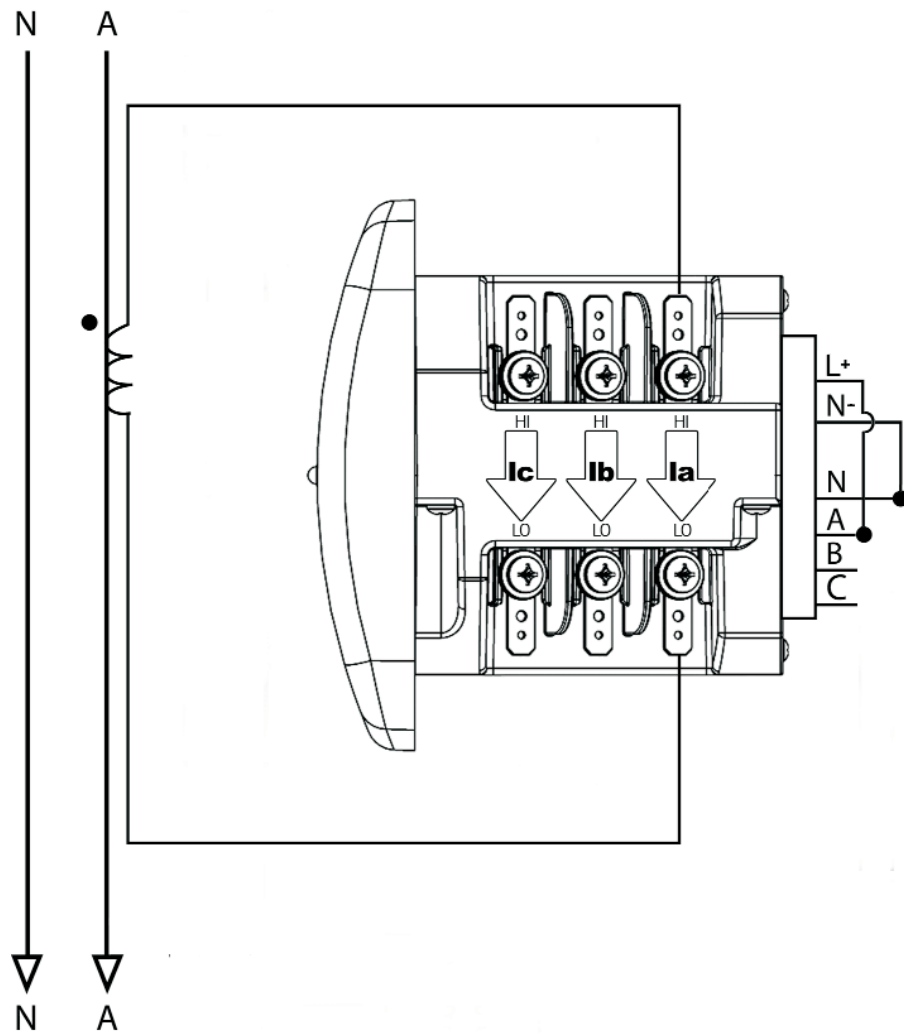

Even if the meter is used only for current measurement, the unit requires a AN volts reference. Please ensure that the voltage input is attached to the meter. AC control power can be used to provide the reference signal.

3.4 Communications Setup

3.4.1 Description

The EPM 6000 Power Metering System provides two independent communication ports. The first port, COM1, is an optical IrDA port. The second port, COM2, provides RS485 communication via the Modbus protocol.

3.4.2 IrDA COM1 Port

The COM1 IrDA port is located on the meter faceplate. The IrDA port allows the unit to be set up and programmed using a remote laptop without the need for a communication cable. Just point at the meter with an IrDA-equipped computer to configure it.

Use the GE Communicator software package that works with the EPM 6000 IrDA port to configure the port and poll readings. Refer to the *GE Communicator User Manual* for details on programming and accessing readings.



FIGURE 3–15: Simultaneous Dual Communications Paths

Settings for the COM1 IrDA port are configured using GE Communicator software. This port communicates via the Modbus ASCII protocol only.

3.4.3 RS485 COM2 Port

The EPM 6000 COM2 port uses standard 2-wire, half-duplex RS485 communications. The RS485 connector is located on the back face of the meter. A connection can easily be established to a master device or to other slave devices, as indicated below.

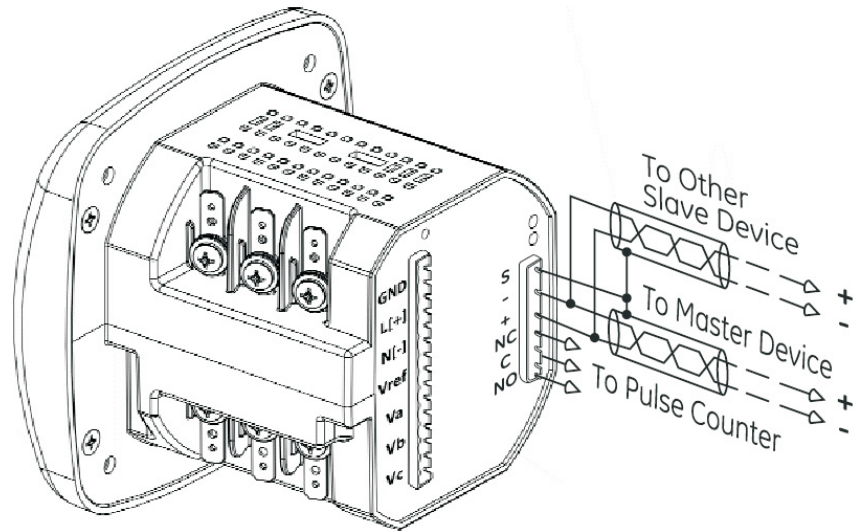

FIGURE 3-16: RS485 Communications Installation

The EPM 6000 COM2 port can be programmed through the faceplate or with software. The standard RS485 port settings are:

Address: 001 to 247

Baud rate: 9.6, 19.2, 38.4, or 57.6 kbps

Protocol: Modbus RTU, Modbus ASCII, or DNP 3.0



EPM 6000 Multi-function Power Metering System

Chapter 4: Using the Meter

4.1 Front Panel Interface

4.1.1 Description

The EPM 6000 Power Metering System can be configured and a variety of functions can be accomplished simply by using the elements and the buttons on the meter faceplate. This chapter will review front panel navigation. Complete navigation maps can be found in *Navigation Maps* on page 6-1.

4.1.2 Faceplate Elements

The meter faceplate elements are described below.

- Reading Type Designator: indicates type of reading.
- IrDA Communication Port: COM1 port for wireless communications.
- % of Load Bar: graphic display of current as a percentage of the load.
- Parameter Designator: indicates the reading displayed.
- Watt-Hour Pulse: energy pulse output to test accuracy.
- Scale Selector: “kilo” or “mega” multiplier of displayed readings.



FIGURE 4-1: EPM 6000 Faceplate Elements

4.1.3 Faceplate Buttons

The following functions can be performed using the **MENU**, **ENTER**, **DOWN** and **RIGHT** buttons:

- View meter information
- Enter display modes
- Configure parameters (password protected)
- Perform resets
- Perform LED checks
- Change settings
- View parameter values
- Scroll parameter values
- View limit states

The faceplate buttons function as follows:

- **Enter** button: Press and release the **ENTER** button to select one of four display modes: *operating* mode (default), *reset* mode (press **ENTER** once, followed by **DOWN**), *settings* mode (press **ENTER** twice, followed by **DOWN**), and *configuration* mode (press **ENTER** three times, followed by **DOWN**).
- **Menu** button: Press and release to navigate the configuration menu and again to return to the main menu.
- **Right** button: Press the **RIGHT** button to enter the menus for the *operate*, *reset*, *settings*, and *configuration* mode.
- **Down** button: Press the **DOWN** button to scroll through the menus for each of the modes.

In *operating* mode (default), the faceplate buttons are used to view parameter values. In *reset* mode, the buttons are used to restore maximum and minimum values. In *settings* mode, the buttons are used to view settings parameters and change the scroll setting. In *configuration* mode, the buttons are used to change meter configuration (in this case, they can be password protected).



FIGURE 4-2: EPM 6000 Faceplate Buttons

4.1.4 Percentage of Load Bar

The 10-segment LED bar graph at the bottom of the EPM 6000 front panel provides a graphic representation of current. The segments illuminate according to the load shown in the table below. When the load is greater than 120% of full-load, all segments flash “ON” for 1.5 seconds and “OFF” for 0.5 seconds.

Table 4-1: % of Load Bar Segments

Segments	Load \geq % Full Load
none	no load
1	1%
1 to 2	15%
1 to 3	30%
1 to 4	45%
1 to 5	60%
1 to 6	72%
1 to 7	84%
1 to 8	96%
1 to 9	108%
1 to 10	120%
all blinking	>120%

4.1.5 Watt-Hour Accuracy Testing (Verification)

To be certified for revenue metering, power providers and utility companies have to verify that the billing energy meter will perform to the stated accuracy. To confirm the meter's performance and calibration, power providers use field test standards to ensure that the unit's energy measurements are correct. Since the EPM 6000 is a traceable revenue meter, it contains a utility grade test pulse that can be used to gate an accuracy standard. This is an essential feature required of all billing grade meters.

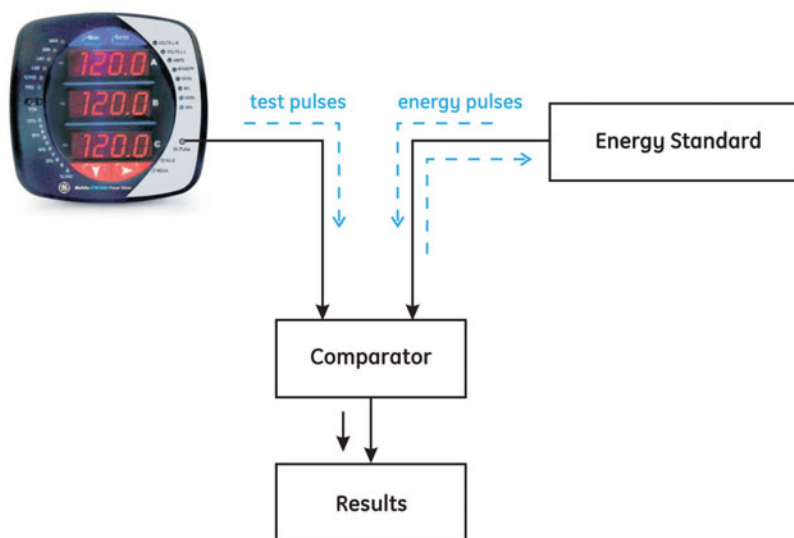

FIGURE 4-3: Using the Watt-Hour Test Probe

The following table lists the watt-hour pulse constants for accuracy testing.

Table 4-2: EPM 6000 Accuracy Test Constants

Voltage Level	Class 10 Models	Class 2 Models
Below 150 V	0.2505759630	0.0501151926
Above 150 V	1.0023038521	0.2004607704

4.2 Configuring the Meter via the Front Panel

4.2.1 Overview

The EPM 6000 front panel can be used to configure the meter. The EPM 6000 has three modes: *operating* mode (default), *IrDA reset* mode, and *configuration* mode. The **MENU**, **ENTER**, **DOWN** and **RIGHT** buttons navigate through the modes and navigate through all the screens in each mode.

A typical setup will be demonstrated in this section; other settings are possible. Complete navigation maps for the display modes are shown in *Navigation Maps* on page 6-1. The meter can also be configured through software.

4.2.2 Start Up

Upon power-up, the meter will display a sequence of screens. The sequence includes the following screens:

- Lamp test screen where all LEDs are lighted;
- Lamp test screen where all digits are lighted;
- Firmware screen showing build number;
- Error screen (if an error exists).

The EPM 6000 will then auto-scroll the parameter designators on the right side of the front panel. Values are displayed for each parameter. The **KILO** or **MEGA** LED will illuminate, showing the scale for the Wh, varh and VAh readings.

An example of a Wh reading is shown below.

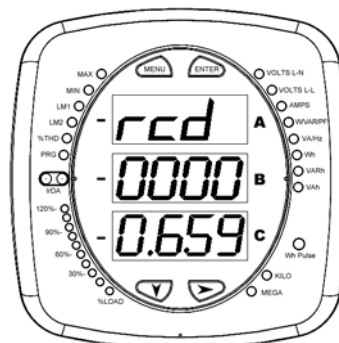

FIGURE 4-4: Typical Wh Reading

The EPM 6000 will continue to scroll through the parameter designators, providing readings until one of the buttons on the front panel is pushed, causing the meter to enter one of the other modes.

4.2.3 Main Menu

The following procedure describes how to navigate the main menu.

- ▷ Push the **MENU** button from any of the auto-scrolling readings to display the main menu screens.
The string for reset mode (`rSt`) will be blinking in the "A" Screen.
- ▷ Press the **DOWN** key to scroll the menu and display the configuration mode string (`CFG`) in the "A" screen.
- ▷ Press the **DOWN** key again to scroll the menu and display the operating mode string in the "A" screen.
- ▷ Press the **DOWN** key again to scroll back to reset mode (`rSt`).
- ▷ Press **ENTER** from the main menu to enter the mode displayed on the "A" screen. See *Main Menu Screens* on page 6-2 for navigation details.

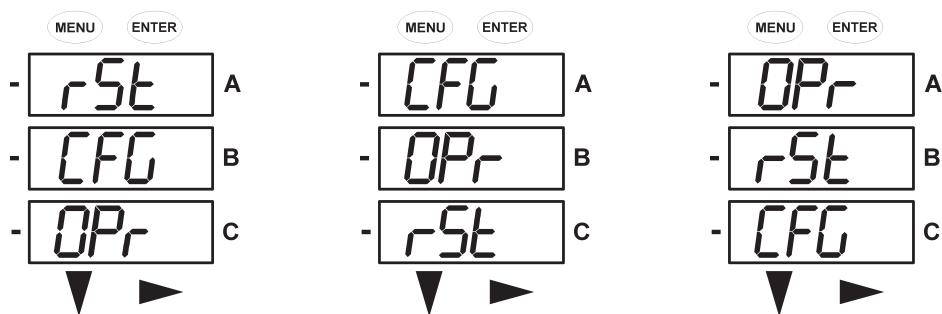
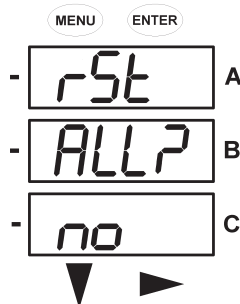

FIGURE 4-5: Main Menu Screens

4.2.4 Reset Mode and Password Entry

The following procedure describes how to navigate the reset mode menu.

- ▷ Press **ENTER** while the "A" screen is in reset mode (i.e., the "A" screen displays `rSt`).
The `rSt ALL? no` message will appear. The `rSt ALL?` function resets all maximum and minimum values.



- ▷ Press **ENTER** to continue scrolling through the main menu.
The **DOWN** button does not change the screen.

- ▷ Press the RIGHT button to display the **rSt ALL? YES** message.

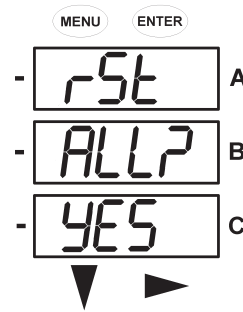

Resetting the maximum and minimum value requires entry of a four-digit password, if enabled in software.

- ▷ Press **ENTER** to display the password screen.

If password is enabled in the software, the screen displays the **PASS** message in the "A" screen and 4 dashes in the "B" screen, with the left-most digit flashing.

- ▷ Using the **DOWN** button, select 0 to 9 for the flashing digit.
- ▷ When the desired number appears, use the **RIGHT** button to select it and move to the next digit.
- ▷ When all four password digits have been selected, press **ENTER**.

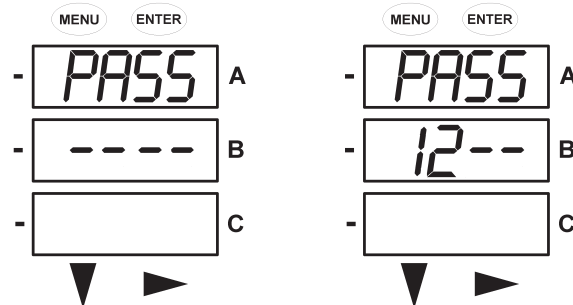

If the correct password has been entered, the **rSt ALL donE** message appears and the screen returns to auto-scroll the parameters.

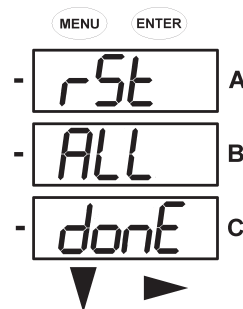

If an incorrect password has been entered, the **PASS - - - - FAIL** message appears and the screen returns to the **rSt ALL? YES** message.

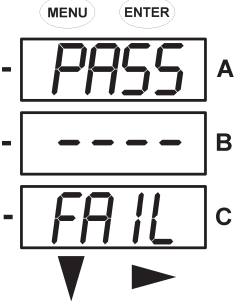

4.3 Changing Settings in Configuration Mode

4.3.1 Description

The following procedure describes how to navigate the configuration mode menu.

- ▷ Press the **MENU** Button from any of the auto-scrolling readings.
- ▷ Press **DOWN** to display the configuration mode (CFG) in the "A" screen.
- w Press **ENTER** to scroll through the configuration parameters, starting at the **SCrL Ct Pt** screen.

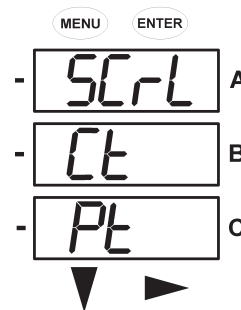

- ▷ Push the **DOWN** Button to scroll all the parameters: scroll, CT, PT, connection (Cnct) and port. The active parameter is always flashing and displayed in the "A" screen.

4.3.2 Configuring the Scroll Feature

Use the following procedure to configure the scroll feature.

- ▷ Press the **ENTER** button to display the **SCrL no** message.
- ▷ Press the **RIGHT** button to change the display to **SCrL YES** as shown below.

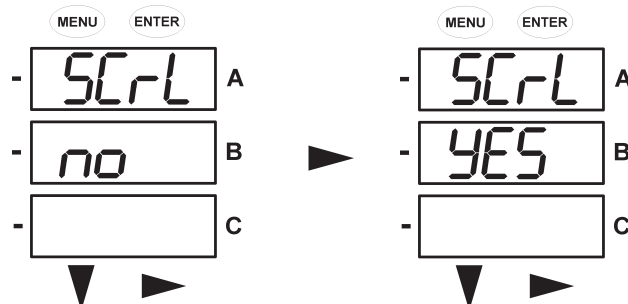

FIGURE 4-6: Scroll Mode Configuration

When in scroll mode, the unit scrolls each parameter for 7 seconds on and 1 second off. The meter can be configured through software to only display selected screens. In this case, it will only scroll the selected displays.

- ▷ Push **ENTER** to select **YES** or **no**.
- ▷ Scroll to the CT parameters screen.

4.3.3 Programming the Configuration Mode Screens

Use the following procedure to program the screen for configuration mode.

- ▷ Press the **DOWN** or **RIGHT** button (for example, from the **ct-n** message below) to display the password screen, if enabled in the software.
- ▷ Use the **DOWN** and **RIGHT** buttons to enter the correct password (refer to *Reset Mode and Password Entry* on page 4-6 for steps on password entry).
- ▷ Once the correct password is entered, push **ENTER**. The **ct-n** message will reappear, the PRG faceplate LED will flash, and the first digit of the “B” screen will also flash.

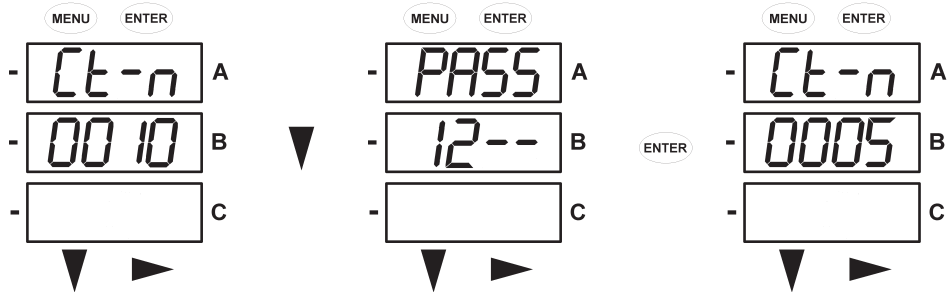

- ▷ Use the **DOWN** button to change the first digit.
- ▷ Use the **RIGHT** button to select and change the successive digits.
- ▷ When the new value is entered, push **ENTER** twice. This will display the **stor ALL? no** screen.
- ▷ Use the **RIGHT** button to scroll to change the value from **no** to **YES**.

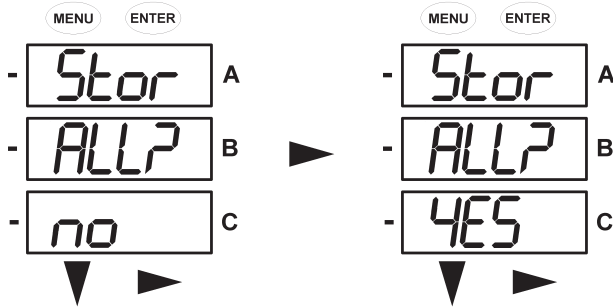

- ▷ When the **stor ALL? YES** message is displayed, press **ENTER** to change the setting.

The **Stor ALL donE** message will appear and the meter will reset.

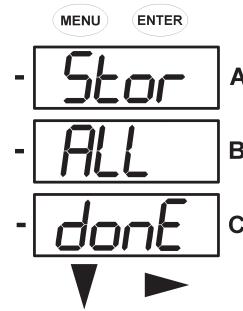

4.3.4 Configuring the CT Setting

Use the following procedure to program the CT setting.

- ▷ Push the **DOWN** Button to scroll through the configuration mode parameters.

Press **ENTER** when **ct** is the active parameter (i.e. it is in the "A" screen and flashing).

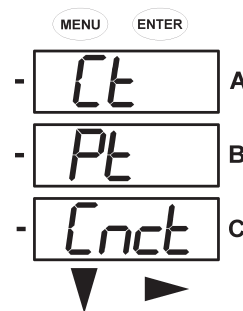

This will display the and the **ct-n** (CT numerator) screen.

- ▷ Press **ENTER** again to change to display the **ct-d** (CT denominator) screen.

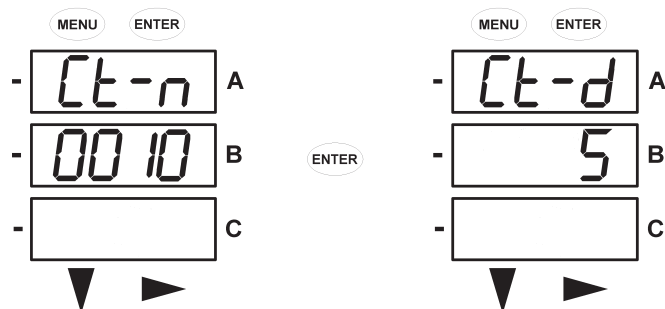

The **ct-d** value is preset to a 1 or 5 A at the factory and cannot be changed.

- ▷ Press ENTER again to select the to $ct-s$ (CT scaling) value.

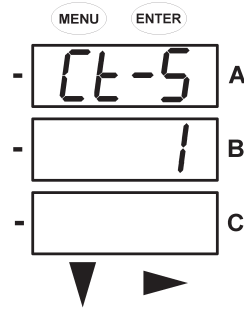

The $ct-s$ value can be "1", "10", or "100". Refer to *Programming the Configuration Mode Screens* on page 4–10 for instructions on changing values.



The value for amps is a product of the $ct-n$ and the $ct-s$ values.

Example settings for the $ct-s$ value are shown below:

200/5 A: set the $ct-n$ value for "200" and the $ct-s$ value for "1"

800/5 A: set the $ct-n$ value for "800" and the $ct-s$ value for "1"

2000/5 A: set the $ct-n$ value for "2000" and the $ct-s$ value for "1".

10000/5 A: set the $ct-n$ value for "1000" and the $ct-s$ value for "10".

- ▷ Press ENTER to scroll through the other CFG parameters. Pressing DOWN or RIGHT displays the password screen (see *Reset Mode and Password Entry* on page 4–6 for details).
- ▷ Press MENU to return to the main configuration menu.



$ct-n$ and $ct-s$ are dictated by primary current. $ct-d$ is secondary current.

4.3.5 Configuring the PT Setting

Use the following procedure to program the PT setting.

- ▷ Push the DOWN Button to scroll through the configuration mode parameters.
- ▷ Press ENTER when PT is the active parameter (i.e. it is in the "A" screen and flashing).

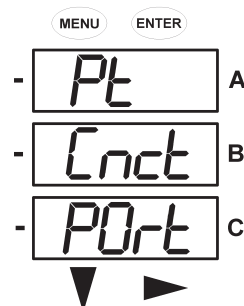

This will display the and the **Pt-n** (PT numerator) screen.

- ▷ Press **ENTER** again to change to display the **Pt-d** (PT denominator) screen.

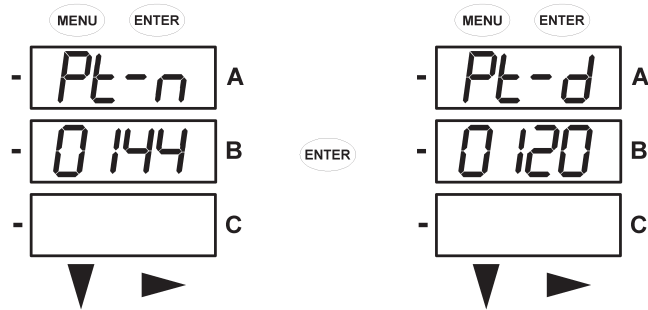

- ▷ Press **ENTER** again to select the to **Pt-s** (PT scaling) value.

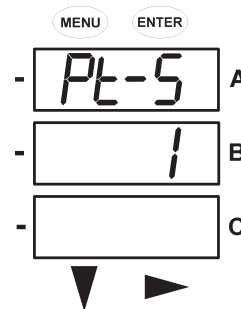

The **Pt-s** value can be "1", "10", or "100". Refer to *Programming the Configuration Mode Screens* on page 4-10 for instructions on changing values.

Example settings for the **Pt-n**, **Pt-d**, and **Pt-s** values are shown below:

- 14400/120 V (reads 14400 V): set **Pt-n** to "1440", **Pt-d** to "120", and **Pt-s** to "10"
- 138000/69 V (reads 138000 V): set **Pt-n** to "1380", **Pt-d** to "69", and **Pt-s** to "100"
- 345000/115 V (reads 347000 V): set **Pt-n** to "3450", **Pt-d** to "115", and **Pt-s** to "100"

- ▷ Press **ENTER** to scroll through the other **CFG** parameters.
- ▷ Press **DOWN** or **RIGHT** to display the password screen (see *Reset Mode and Password Entry* on page 4-6 for details).
- ▷ Press **MENU** to return to the main configuration menu.



Pt-n and **Pt-s** are dictated by primary voltage. **Pt-d** is secondary voltage.

4.3.6 Configuring the Connection Setting

Use the following procedure to program the connection (**Cnct**) setting.

- ▷ Push the **DOWN** Button to scroll through the configuration mode parameters.
- ▷ Press **ENTER** when **Cnct** is the active parameter (i.e. it is in the “A” screen and flashing).

This will display the **Cnct** (connection) screen. The possible connection configurations are 3-element Wye (**3 EL WYE**), 2.5-element Wye (**2.5EL WYE**), and 2 CT Delta (**2 Ct deL**), as shown below.

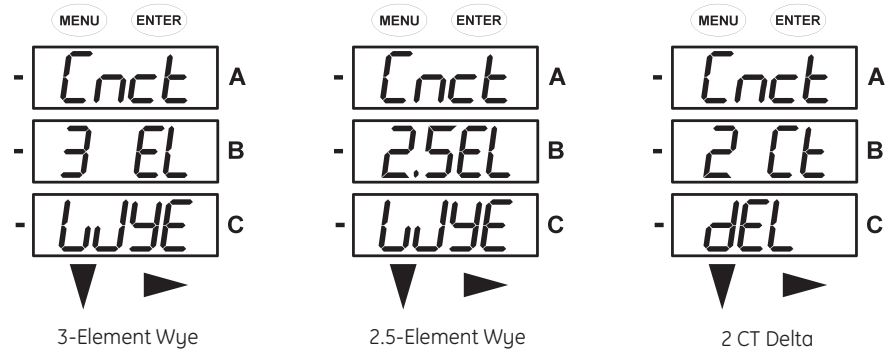

- ▷ Press **ENTER** to scroll through the other **CFG** parameters.
- ▷ Press **DOWN** or **RIGHT** to display the password screen (see *Reset Mode and Password Entry* on page 4–6 for details).
- ▷ Press **MENU** to return to the main configuration menu.

4.3.7 Configuring the Communication Port Setting

Use the following procedure to program the communication port (**Port**) settings.

- ▷ Push the **DOWN** Button to scroll through the configuration mode parameters.
- ▷ Press **ENTER** when **Port** is the active parameter (i.e. it is in the “A” screen and flashing).

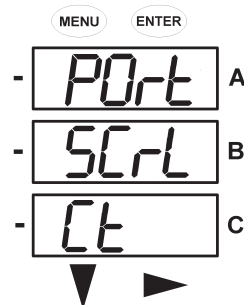

The following parameters can be configured through the **Port** menu

- The meter address (**Adr**, a 3-digit number).
- The baud rate (**baud**). Select from “9600”, “19.2”, “38.4”, and “57.6” for 9600, 19200, 38400, and 57600 kbps, respectively.
- The communications protocol (**Prot**).

- ▷ Select "rtU" for Modbus RTU, "ASCI" for Modbus ASCII, and "dnP" for the DNP 3.0 protocol.
- The first **Port** screen is meter address (**Adr**). The current address appears on the screen.
 - ▷ Select three-digit number for the address.
Refer to *Programming the Configuration Mode Screens* on page 4–10 for details on changing values.

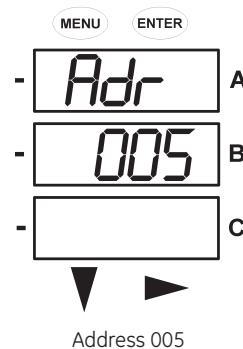

- The next **Port** screen is the baud rate (**baUd**). The current baud rate is displayed on the "B" screen. Refer to *Programming the Configuration Mode Screens* on page 4–10 for details on changing values. The possible baud rate screens are shown below.

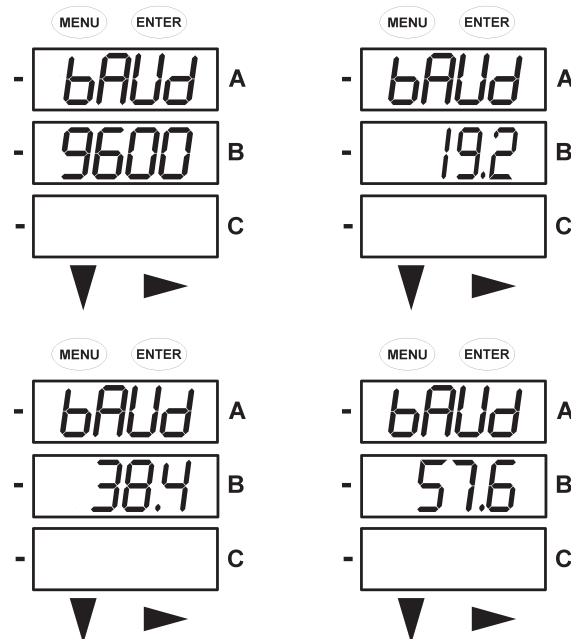

- The final **Port** screen is the communications protocol (**Prot**). The current protocol is displayed on the "B" screen. Refer to *Programming the Configuration Mode Screens* on page 4–10 for details on changing values. The three protocol selections are shown below.

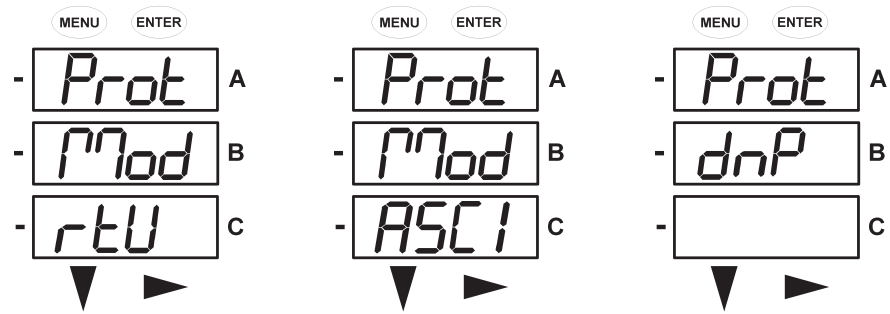

- ▷ Press ENTER to scroll through the other `CFG` parameters.
- ▷ Press DOWN or RIGHT to display the password screen (see *Reset Mode and Password Entry* on page 4–6 for details).
- ▷ Press MENU to return to the main configuration menu.

4.4 Operating Mode

4.4.1 Description

Operating mode is the EPM 6000 meter's default mode. If scrolling is enabled, the meter automatically scrolls through these parameter screens after startup. The screen changes every 7 seconds. Scrolling is suspended for 3 minutes after any button is pressed.

Push the **DOWN** button to scroll all the parameters in operating mode. The active parameter has the indicator light next to it on the right face of the meter. Push the **RIGHT** button to view additional displays for that parameter. A table of the possible displays in the operating mode is below. Refer to *Operating Mode Screens* on page 6-3 for a detailed navigation map of the operating mode.

Table 4-3: Operating Mode Parameter Readings

Parameter designator	Possible display readings			
VOLTS L-N	VOLTS_LN	VOLTS_LN_MAX	VOLTS_LN_MIN	VOLTS_LN_THD
VOLTS L-L	VOLTS_LL	VOLTS_LL_MAX	VOLTS_LL_MIN	
AMPS	AMPS_MAX	AMPS_MIN	AMPS_THD	
W/VAR/PF	W_VAR_PF	W_VAR_PF_MAX_POS	W_VAR_PF_MIN_POS	W_VAR_PF_MAX_NEG
VA/Hz	VA_FREQ	VA_FREQ_MAX	VA_FREQ_MIN	
Wh	KWH_REC	KWH_DEL	KWH_NET	
VARh	KVARH_POS	KVARH_NEG	KVARH_NET	
VAh	KVAH			



Readings or groups of readings are skipped if not applicable to the meter type or hookup, or if explicitly disabled in the programmable settings.



EPM 6000 Multi-function Power Metering System

Chapter 5: Communications

5.1 Modbus Communications

5.1.1 Memory Map Description

The Modbus memory map is divided into four primary sections:

1. Fixed data registers: addresses 0001 to 0021.
2. Meter data registers: addresses 1000 to 5003.

The meter data registers read as "0" until the first readings are available or if the meter is not in operating mode. Writes to these registers will be accepted but will have no effect on the register.

3. Command registers: addresses 20000 to 26011.

The command registers always read as "0". They may be written only when the meter is in a suitable mode. The registers return an illegal data address exception if a write is attempted in an incorrect mode.

4. Programmable settings registers: addresses 30000 to 30026.

All registers explicitly listed in the table read as "0". Writes to these registers will be accepted but won't actually the register, since it doesn't exist.

5.1.2 Memory Map

The Modbus memory map is shown below. Additional notes indicated in the memory map ("See Note ...") are located at the end of the table, as well as a description of the format codes.

HEX ADDRESS	DESCRIPTION ¹	FORMAT	RANGE ⁶	UNITS OR RESOLUTION	COMMENTS	# REG
FIXED DATA SECTION						
Identification Block						read-only
0000 - 0007	Meter Name	ASCII	16 char	none		8
0008 - 000F	Meter Serial Number	ASCII	16 char	none		8
0010 - 0010	Meter Type	UINT16	bit-mapped	-----t-----vvv	t = transducer model (1=yes, 0=no), vvv = V-switch(1 to 4)	1
0011 - 0012	Firmware Version	ASCII	4 char	none		2
0013 - 0013	Map Version	UINT16	0 to 65535	none		1
0014 - 0014	Meter Configuration	UINT16	bit-mapped	----- --fffff	fffff = calibration frequency (50 or 60)	1
0015 - 0015	ASIC Version	UINT16	0-65535	none		1
0016 - 0026	Reserved					17
0027 - 002E	GE Part Number	ASCII	16 char	none		8
					Block Size:	47
METER DATA SECTION²						
Primary Readings Block, 6 cycles (IEEE Floating Point)						read-only
0383 - 0384	Watts, 3-Ph total	FLOAT	-9999 M to +9999 M	watts		2
0385 - 0386	VARs, 3-Ph total	FLOAT	-9999 M to +9999 M	VARs		2
0387 - 0388	VAs, 3-Ph total	FLOAT	-9999 M to +9999 M	VAs		2
					Block Size:	6
Primary Readings Block, 60 cycles (IEEE Floating Point)						read-only
03E7 - 03E8	Volts A-N	FLOAT	0 to 9999 M	volts		2
03E9 - 03EA	Volts B-N	FLOAT	0 to 9999 M	volts		2
03EB - 03EC	Volts C-N	FLOAT	0 to 9999 M	volts		2
03ED - 03EE	Volts A-B	FLOAT	0 to 9999 M	volts		2
03EF - 03F0	Volts B-C	FLOAT	0 to 9999 M	volts		2
03F1 - 03F2	Volts C-A	FLOAT	0 to 9999 M	volts		2
03F3 - 03F4	Amps A	FLOAT	0 to 9999 M	amps		2
03F5 - 03F6	Amps B	FLOAT	0 to 9999 M	amps		2
03F7 - 03F8	Amps C	FLOAT	0 to 9999 M	amps		2
03F9 - 03FA	Watts, 3-Ph total	FLOAT	-9999 M to +9999 M	watts		2
03FB - 03FC	VARs, 3-Ph total	FLOAT	-9999 M to +9999 M	VARs		2
03FD - 03FE	VAs, 3-Ph total	FLOAT	-9999 M to +9999 M	VAs		2
03FF - 0400	Power Factor, 3-Ph total	FLOAT	-1.00 to +1.00	none		2
0401 - 0402	Frequency	FLOAT	0 to 65.00	Hz		2
0403 - 0404	Neutral Current	FLOAT	0 to 9999 M	amps		2
					Block Size:	30
Primary Energy Block						read-only
044B - 044C	W-hours, Received	SINT32	0 to 99999999 or -99999999	0 to Wh per energy format	* Wh received & delivered always have opposite signs	2
044D - 044E	W-hours, Delivered	SINT32	0 to 99999999 or -99999999	0 to Wh per energy format	* Wh received is positive for "view as load", delivered is positive for "view as generator"	2
044F - 0450	W-hours, Net	SINT32	-99999999 to 99999999	Wh per energy format		2
0451 - 0452	W-hours, Total	SINT32	0 to 99999999	Wh per energy format	* 5 to 8 digits	2
0453 - 0454	VAR-hours, Positive	SINT32	0 to 99999999	VARh per energy format	* decimal point implied, per energy format	2
0455 - 0456	VAR-hours, Negative	SINT32	0 to -99999999	VARh per energy format	* resolution of digit before decimal point = units, kilo, or mega, per energy format	2
0457 - 0458	VAR-hours, Net	SINT32	-99999999 to 99999999	VARh per energy format		2

HEX ADDRESS	DESCRIPTION ¹	FORMAT	RANGE ⁶	UNITS OR RESOLUTION	COMMENTS	# REG
0459 - 045A	VAR-hours, Total	SINT32	0 to 99999999	VARh per energy format		2
045B - 045C	VA-hours, Total	SINT32	0 to 99999999	VAh per energy format	* see note 10	2
					Block Size:	18
Primary Demand Block (IEEE Floating Point)					read-only	
07CF - 07D0	Amps A, Average	FLOAT	0 to 9999 M	amps		2
07D1 - 07D2	Amps B, Average	FLOAT	0 to 9999 M	amps		2
07D3 - 07D4	Amps C, Average	FLOAT	0 to 9999 M	amps		2
07D5 - 07D6	Positive Watts, 3-Ph, Average	FLOAT	-9999 M to +9999 M	watts		2
07D7 - 07D8	Positive VARs, 3-Ph, Average	FLOAT	-9999 M to +9999 M	VARs		2
07D9 - 07DA	Negative Watts, 3-Ph, Average	FLOAT	-9999 M to +9999 M	watts		2
07DB - 07DC	Negative VARs, 3-Ph, Average	FLOAT	-9999 M to +9999 M	VARs		2
07DD - 07DE	VAs, 3-Ph, Average	FLOAT	-9999 M to +9999 M	VAs		2
07DF - 07E0	Positive PF, 3-Ph, Average	FLOAT	-1.00 to +1.00	none		2
07E1 - 07E2	Negative PF, 3-Ph, Average	FLOAT	-1.00 to +1.00	none		2
					Block Size:	20
Primary Minimum Block (IEEE Floating Point)					read-only	
0BB7 - 0BB8	Volts A-N, Minimum	FLOAT	0 to 9999 M	volts		2
0BB9 - 0BBA	Volts B-N, Minimum	FLOAT	0 to 9999 M	volts		2
0BBB - 0BBC	Volts C-N, Minimum	FLOAT	0 to 9999 M	volts		2
0BBD - 0BBE	Volts A-B, Minimum	FLOAT	0 to 9999 M	volts		2
0BBF - 0BC0	Volts B-C, Minimum	FLOAT	0 to 9999 M	volts		2
0BC1 - 0BC2	Volts C-A, Minimum	FLOAT	0 to 9999 M	volts		2
0BC3 - 0BC4	Amps A, Minimum Avg Demand	FLOAT	0 to 9999 M	amps		2
0BC5 - 0BC6	Amps B, Minimum Avg Demand	FLOAT	0 to 9999 M	amps		2
0BC7 - 0BC8	Amps C, Minimum Avg Demand	FLOAT	0 to 9999 M	amps		2
0BC9 - 0BCA	Positive Watts, 3-Ph, Minimum Avg Demand	FLOAT	0 to +9999 M	watts		2
0BCB - 0BCC	Positive VARs, 3-Ph, Minimum Avg Demand	FLOAT	0 to +9999 M	VARs		2
0BCD - 0BCE	Negative Watts, 3-Ph, Minimum Avg Demand	FLOAT	0 to +9999 M	watts		2
0BCF - 0BD0	Negative VARs, 3-Ph, Minimum Avg Demand	FLOAT	0 to +9999 M	VARs		2
0BD1 - 0BD2	VAs, 3-Ph, Minimum Avg Demand	FLOAT	-9999 M to +9999 M	VAs		2
0BD3 - 0BD4	Positive Power Factor, 3-Ph, Minimum Avg Demand	FLOAT	-1.00 to +1.00	none		2
0BD5 - 0BD6	Negative Power Factor, 3-Ph, Minimum Avg Demand	FLOAT	-1.00 to +1.00	none		2
0BD7 - 0BD8	Frequency, Minimum	FLOAT	0 to 65.00	Hz		2
					Block Size:	34
Primary Maximum Block (IEEE Floating Point)					read-only	
0C1B - 0C1C	Volts A-N, Maximum	FLOAT	0 to 9999 M	volts		2
0C1D - 0C1E	Volts B-N, Maximum	FLOAT	0 to 9999 M	volts		2
0C1F - 0C20	Volts C-N, Maximum	FLOAT	0 to 9999 M	volts		2
0C21 - 0C22	Volts A-B, Maximum	FLOAT	0 to 9999 M	volts		2
0C23 - 0C24	Volts B-C, Maximum	FLOAT	0 to 9999 M	volts		2
0C25 - 0C26	Volts C-A, Maximum	FLOAT	0 to 9999 M	volts		2
0C27 - 0C28	Amps A, Maximum Avg Demand	FLOAT	0 to 9999 M	amps		2
0C29 - 0C2A	Amps B, Maximum Avg Demand	FLOAT	0 to 9999 M	amps		2
0C2B - 0C2C	Amps C, Maximum Avg Demand	FLOAT	0 to 9999 M	amps		2
0C2D - 0C2E	Positive Watts, 3-Ph, Maximum Avg Demand	FLOAT	0 to +9999 M	watts		2

HEX ADDRESS	DESCRIPTION ¹	FORMAT	RANGE ⁶	UNITS OR RESOLUTION	COMMENTS	# REG
0C2F - 0C30	Positive VARs, 3-Ph, Maximum Avg Demand	FLOAT	0 to +9999 M	VARs		2
0C31 - 0C32	Negative Watts, 3-Ph, Maximum Avg Demand	FLOAT	0 to +9999 M	watts		2
0C33 - 0C34	Negative VARs, 3-Ph, Maximum Avg Demand	FLOAT	0 to +9999 M	VARs		2
0C35 - 0C36	VAs, 3-Ph, Maximum Avg Demand	FLOAT	-9999 M to +9999 M	VAs		2
0C37 - 0C38	Positive Power Factor, 3-Ph, Maximum Avg Demand	FLOAT	-1.00 to +1.00	none		2
0C39 - 0C3A	Negative Power Factor, 3-Ph, Maximum Avg Demand	FLOAT	-1.00 to +1.00	none		2
0C3B - 0C3C	Frequency, Maximum	FLOAT	0 to 65.00	Hz		2
					Block Size:	34
THD Block^{7, 13}					read-only	
0F9F - 0F9F	Volts A-N, %THD	UINT16	0 to 9999, or 65535	0.1%		1
0FA0 - 0FA0	Volts B-N, %THD	UINT16	0 to 9999, or 65535	0.1%		1
0FA1 - 0FA1	Volts C-N, %THD	UINT16	0 to 9999, or 65535	0.1%		1
0FA2 - 0FA2	Amps A, %THD	UINT16	0 to 9999, or 65535	0.1%		1
0FA3 - 0FA3	Amps B, %THD	UINT16	0 to 9999, or 65535	0.1%		1
0FA4 - 0FA4	Amps C, %THD	UINT16	0 to 9999, or 65535	0.1%		1
0FA5 - 0FA5	Phase A Current 0th harmonic magnitude	UINT16	0 to 65535	none		1
0FA6 - 0FA6	Phase A Current 1st harmonic magnitude	UINT16	0 to 65535	none		1
0FA7 - 0FA7	Phase A Current 2nd harmonic magnitude	UINT16	0 to 65535	none		1
0FA8 - 0FA8	Phase A Current 3rd harmonic magnitude	UINT16	0 to 65535	none		1
0FA9 - 0FA9	Phase A Current 4th harmonic magnitude	UINT16	0 to 65535	none		1
0FAA - 0FAA	Phase A Current 5th harmonic magnitude	UINT16	0 to 65535	none		1
0FAB - 0FAB	Phase A Current 6th harmonic magnitude	UINT16	0 to 65535	none		1
0FAC - 0FAC	Phase A Current 7th harmonic magnitude	UINT16	0 to 65535	none		1
0FAD - 0FAD	Phase A Voltage 0th harmonic magnitude	UINT16	0 to 65535	none		1
0FAE - 0FAE	Phase A Voltage 1st harmonic magnitude	UINT16	0 to 65535	none		1
0FAF - 0FAF	Phase A Voltage 2nd harmonic magnitude	UINT16	0 to 65535	none		1
0FB0 - 0FB0	Phase A Voltage 3rd harmonic magnitude	UINT16	0 to 65535	none		1
0FB1 - 0FB8	Phase B Current	same as Phase A Current 0th to 7th harmonic magnitudes				8
0FB9 - 0FBC	Phase B Voltage	same as Phase A Voltage 0th to 3rd harmonic magnitudes				4
0FBD - 0FC4	Phase C Current	same as Phase A Current 0th to 7th harmonic magnitudes				8
0FC5 - 0FC8	Phase C Voltage	same as Phase A Voltage 0th to 3rd harmonic magnitudes				4
					Block Size:	42
Phase Angle Block¹⁴					read-only	
1003 - 1003	Phase A Current	SINT16	-1800 to +1800	0.1 degree		1
1004 - 1004	Phase B Current	SINT16	-1800 to +1800	0.1 degree		1
1005 - 1005	Phase C Current	SINT16	-1800 to +1800	0.1 degree		1
1006 - 1006	Angle, Volts A-B	SINT16	-1800 to +1800	0.1 degree		1
1007 - 1007	Angle, Volts B-C	SINT16	-1800 to +1800	0.1 degree		1
1008 - 1008	Angle, Volts C-A	SINT16	-1800 to +1800	0.1 degree		1
					Block Size:	6

HEX ADDRESS	DESCRIPTION ¹	FORMAT	RANGE ⁶	UNITS OR RESOLUTION	COMMENTS	# REG
Status Block					read-only	
1387 - 1387	Meter Status	UINT16	bit-mapped	--expnch ssssssss	expnch = EEPROM block OK flags e=energy, x=max, n=min, p=programmable settings, c=calibration, h=header), sssssss = state (1=Run, 2=Limp, 10=Prog Set Update via buttons, 11=Prog Set Update via IrDA, 12=Prog Set Update via COM2)	1
1388 - 1388	Limits Status ⁷	UINT16	bit-mapped	87654321 87654321	high byte is setpt 1, 0=in, 1=out low byte is setpt 2, 0=in, 1=out	1
1389 - 138A	Time Since Reset	UINT32	0 to 4294967294	4 msec	wraps around after max count	2
					Block Size:	4
COMMANDS SECTION⁴						
Resets Block⁹					write-only	
4E1F - 4E1F	Reset Max/Min Blocks	UINT16	password ⁵			1
4E20 - 4E20	Reset Energy Accumulators	UINT16	password ⁵			1
					Block Size:	2
Meter Programming Block					read/conditional write	
55EF - 55EF	Initiate Programmable Settings Update	UINT16	password ⁵		meter enters PS update mode	1
55F0 - 55F0	Terminate Programmable Settings Update ³	UINT16	any value		meter leaves PS update mode via reset	1
55F1 - 55F1	Calculate Programmable Settings Checksum ³	UINT16			meter calculates checksum on RAM copy of PS block	1
55F2 - 55F2	Programmable Settings Checksum ³	UINT16			read/write checksum register; PS block saved in EEPROM on write ⁸	1
55F3 - 55F3	Write New Password ³	UINT16	0000 to 9999		write-only register; always reads zero	1
59D7 - 59D7	Initiate Meter Firmware Reprogramming	UINT16	password ⁵			1
					Block Size:	6
Other Commands Block					read/write	
61A7 - 61A7	Force Meter Restart	UINT16	password ⁵		causes a watchdog reset, always reads 0	1
					Block Size:	1
Encryption Block					read/write	
658F - 659A	Perform a Secure Operation	UINT16			encrypted command to read password or change meter type	12
					Block Size:	12
PROGRAMMABLE SETTINGS SECTION						
Basic Setups Block					write only in PS update mode	
752F - 752F	CT multiplier & denominator	UINT16	bit-mapped	ddddddd mmmmmmmm	high byte is denominator (1 or 5, read-only), low byte is multiplier (1, 10, or 100)	1
7530 - 7530	CT numerator	UINT16	1 to 9999	none		1
7531 - 7531	PT numerator	UINT16	1 to 9999	none		1

HEX ADDRESS	DESCRIPTION ¹	FORMAT	RANGE ⁶	UNITS OR RESOLUTION	COMMENTS	# REG
7532 - 7532	PT denominator	UINT16	1 to 9999	none		1
7533 - 7533	PT multiplier & hookup	UINT16	bit-mapped	mmmmmmmm MMMMh hhh	MMMMmmmmmm is PT multiplier (1, 10, 100, 1000), hhhh is hookup enumeration (0 = 3 element wye(9S), 1 = delta 2 CTs(5S), 3 = 2.5 element wye(6S))	1
7534 - 7534	Averaging Method	UINT16	bit-mapped	--iiii b----sss	iiii = interval (5,15,30,60) b = 0=block or 1=rolling sss = # subintervals (1,2,3,4)	1
7535 - 7535	Power & Energy Format	UINT16	bit-mapped	pppp--nn -eee-ddd	pppp = power scale (0=unit, 3=kilo, 6=mega, 8=auto) nn = number of energy digits (5-8 --> 0-3) eee = energy scale (0=unit, 3=kilo, 6=mega) ddd = energy digits after decimal point (0-6) See note 10.	1
7536 - 7536	Operating Mode Screen Enables	UINT16	bit-mapped	00000000 eeeeeeee	eeeeeeee = op mode screen rows on(1) or off(0), rows top to bottom are bits low order to high order	1
7537 - 753D	Reserved					7
753E - 753E	User Settings Flags	UINT16	bit-mapped	---g--nn srp--wf-	g = enable alternate full scale bargraph current (1=on, 0=off) nn = number of phases for voltage & current screens (3=ABC, 2=AB, 1=A, 0=ABC) s = scroll (1=on, 0=off) r = password for reset in use (1=on, 0=off) p = password for configuration in use (1=on, 0=off) w = pwr dir (0-view as load, 1-view as generator) f = flip power factor sign (1=yes, 0=no)	1
753F - 753F	Full Scale Current (for load % bargraph)	UINT16	0 to 9999	none	If non-zero and user settings bit g is set, this value replaces CT numerator in the full scale current calculation.	1
7540 - 7547	Meter Designation	ASCII	16 char	none		8
7548 - 7548	COM1 setup	UINT16	bit-mapped	----dddd -0100110	dddd = reply delay (* 50 msec) ppp = protocol (1=Modbus RTU, 2=Modbus ASCII, 3=DNP)	1
7549 - 7549	COM2 setup	UINT16	bit-mapped	----dddd -ppp-bbb	bbb = baud rate (1-9600, 2-19200, 4-38400, 6-57600)	1
754A - 754A	COM2 address	UINT16	1 to 247	none		1
754B - 754B	Limit #1 Identifier	UINT16	0 to 65535		use Modbus address as the identifier (see notes 7, 11, 12)	1
754C - 754C	Limit #1 Out High Setpoint	SINT16	-200.0 to +200.0	0.1% of full scale	Setpoint for the "above" limit (LM1), see notes 11-12.	1
754D - 754D	Limit #1 In High Threshold	SINT16	-200.0 to +200.0	0.1% of full scale	Threshold at which "above" limit clears; normally less than or equal to the "above" setpoint; see notes 11-12.	1
754E - 754E	Limit #1 Out Low Setpoint	SINT16	-200.0 to +200.0	0.1% of full scale	Setpoint for the "below" limit (LM2), see notes 11-12.	1
754F - 754F	Limit #1 In Low Threshold	SINT16	-200.0 to +200.0	0.1% of full scale	Threshold at which "below" limit clears; normally greater than or equal to the "below" setpoint; see notes 11-12.	1

HEX ADDRESS	DESCRIPTION ¹	FORMAT	RANGE ⁶	UNITS OR RESOLUTION	COMMENTS	# REG
7550 - 7554	Limit #2	SINT16	same as Limit #1	same as Limit #1	same as Limit #1	5
7555 - 7559	Limit #3	SINT16				5
755A - 755E	Limit #4	SINT16				5
755F - 7563	Limit #5	SINT16				5
7564 - 7568	Limit #6	SINT16				5
7569 - 756D	Limit #7	SINT16				5
756E - 7572	Limit #8	SINT16				5
SECONDARY READINGS SECTION						
Secondary Block					read-only except as noted	
9C40 - 9C40	System Sanity Indicator	UINT16	0 or 1	none	0 indicates proper meter operation	1
9C41 - 9C41	Volts A-N	UINT16	2047 to 4095	volts	2047= 0, 4095= +150	1
9C42 - 9C42	Volts B-N	UINT16	2047 to 4095	volts	volts = 150 * (register - 2047) / 2047	1
9C43 - 9C43	Volts C-N	UINT16	2047 to 4095	volts		1
9C44 - 9C44	Amps A	UINT16	0 to 4095	amps	0= -10, 2047= 0, 4095= +10	1
9C45 - 9C45	Amps B	UINT16	0 to 4095	amps	amps = 10 * (register - 2047) / 2047	1
9C46 - 9C46	Amps C	UINT16	0 to 4095	amps		1
9C47 - 9C47	Watts, 3-Ph total	UINT16	0 to 4095	watts	0= -3000, 2047= 0, 4095= +3000	1
9C48 - 9C48	VARs, 3-Ph total	UINT16	0 to 4095	VARs	watts, VARs, VAs =	1
9C49 - 9C49	VAs, 3-Ph total	UINT16	2047 to 4095	VAs	3000 * (register - 2047) / 2047	1
9C4A - 9C4A	Power Factor, 3-Ph total	UINT16	1047 to 3047	none	1047= -1, 2047= 0, 3047= +1 pf = (register - 2047) / 1000	1
9C4B - 9C4B	Frequency	UINT16	0 to 2730	Hz	0= 45 or less, 2047= 60, 2730= 65 or more freq = 45 + ((register / 4095) * 30)	1
9C4C - 9C4C	Volts A-B	UINT16	2047 to 4095	volts	2047= 0, 4095= +300 volts = 300 * (register - 2047) / 2047	1
9C4D - 9C4D	Volts B-C	UINT16	2047 to 4095	volts		1
9C4E - 9C4E	Volts C-A	UINT16	2047 to 4095	volts		1
9C4F - 9C4F	CT numerator	UINT16	1 to 9999	none	CT = numerator * multiplier / denominator	1
9C50 - 9C50	CT multiplier	UINT16	1, 10, 100	none		1
9C51 - 9C51	CT denominator	UINT16	1 or 5	none	PT = numerator * multiplier / denominator	1
9C52 - 9C52	PT numerator	UINT16	1 to 9999	none		1
9C53 - 9C53	PT multiplier	UINT16	1, 10, 100	none		1
9C54 - 9C54	PT denominator	UINT16	1 to 9999	none	* 5 to 8 digits	1
9C55 - 9C56	W-hours, Positive	UINT32	0 to 99999999	Wh per energy format		2
9C57 - 9C58	W-hours, Negative	UINT32	0 to 99999999	Wh per energy format	* decimal point implied, per energy format	2
9C59 - 9C5A	VAR-hours, Positive	UINT32	0 to 99999999	VARh per energy format	* resolution of digit before decimal point = units, kilo, or mega, per energy format	2
9C5B - 9C5C	VAR-hours, Negative	UINT32	0 to 99999999	VARh per energy format		2
9C5D - 9C5E	VA-hours	UINT32	0 to 99999999	VAh per energy format	* see note 10	2
9C5F - 9C5F	Neutral Current	UINT16	0 to 4095	amps	see Amps A/B/C above	1
9C60 - 9CA2	Reserved	N/A	N/A	none		67
9CA3 - 9CA3	Reset Energy Accumulators	UINT16	password ⁵		write-only register; always reads as 0	1
					Block Size:	100

5.1.3 Modbus Memory Map Notes

The memory map notes are indicated by number below.

1. All registers not explicitly listed in the table read as 0. Writes to these registers will be accepted but won't actually change the register (since it doesn't exist).

2. Meter Data Section items read as 0 until first readings are available or if the meter is not in operating mode. Writes to these registers will be accepted but won't actually change the register.
3. Register valid only in programmable settings update mode. In other modes these registers read as 0 and return an illegal data address exception if a write is attempted.
4. Meter command registers always read as 0. They may be written only when the meter is in a suitable mode. The registers return an illegal data address exception if a write is attempted in an incorrect mode.
5. If the password is incorrect, a valid response is returned but the command is not executed. Use 5555 for the password if passwords are disabled in the programmable settings.
6. M denotes a 1,000,000 multiplier.
7. Not applicable to Shark 100, V-Switch 1, 2, or 3
8. Writing this register causes data to be saved permanently in EEPROM. If there is an error while saving, a slave device failure exception is returned and programmable settings mode automatically terminates via reset.
9. Reset commands make no sense if the meter state is LIMP. An illegal function exception will be returned.
10. Energy registers should be reset after a format change.
11. Entities to be monitored against limits are identified by Modbus address. Entities occupying multiple Modbus registers, such as floating point values, are identified by the lower register address. If any of the 8 limits is unused, set its identifier to zero. If the indicated Modbus register is not used or is a non-sensical entity for limits, it will behave as an unused limit.
12. There are 2 setpoints per limit, one above and one below the expected range of values. LM1 is the "too high" limit, LM2 is "too low". The entity goes "out of limit" on LM1 when its value is greater than the setpoint. It remains "out of limit" until the value drops below the in threshold. LM2 works similarly, in the opposite direction. If limits in only one direction are of interest, set the in threshold on the "wrong" side of the setpoint. Limits are specified as % of full scale, where full scale is automatically set appropriately for the entity being monitored:
 - current FS = CT numerator * CT multiplier
 - voltage FS = PT numerator * PT multiplier
 - power FS = CT numerator * CT multiplier * PT numerator * PT multiplier * 3 [* SQRT(3) for delta hookup]
 - frequency FS = 60 (or 50)
 - power factor FS = 1.0
 - percentage FS = 100.0
 - angle FS = 180.0
13. THD not available shows 65535 (=0xFFFF) in all THD and harmonic magnitude registers for the channel when V-switch=4. THD may be unavailable due to low V or I amplitude, or delta hookup (V only).

14. All 3 voltage angles are measured for Wye and Delta hookups. For 2.5 Element, Vac is measured and Vab & Vbc are calculated. If a voltage phase is missing, the two voltage angles in which it participates are set to zero. A and C phase current angles are measured for all hookups. B phase current angle is measured for Wye and is zero for other hookups. If a voltage phase is missing, its current angle is zero.

5.1.4 Modbus Memory Map Data Formats

The data format codes indicated in the **Format** column of the Modbus memory map are described below:

ASCII: ASCII characters packed 2 per register in high, low order and without any termination characters. For example, "Shark100" would be 4 registers containing 0x5378, 0x6172, 0x6B31, 0x3030.

SINT16 / UINT16: 16-bit signed / unsigned integer.

SINT32 / UINT32: 32-bit signed / unsigned integer spanning 2 registers. The lower-addressed register is the high order half.

FLOAT: 32-bit IEEE floating point number spanning 2 registers. The lower-addressed register is the high order half (i.e., contains the exponent).

5.2 DNP Point Mapping

5.2.1 DNP Point Maps

The DNP point mappings (DNP-11 to DNP-22) for the EPM 6000 Power Metering System shows the client-server relationship in GE Multilin's use of the DNP protocol. The notes are listed after the table.

Table 5–1: DNP Point Mapping (Sheet 1 of 2)

Object	Var	Point	Description	Format	Range/units	Multiplier	Comments
Binary output states (Read via Class 0 only)							
10	2	0	Reset energy counters	BYTE	0	N/A	
		1	Change to Modbus RTU protocol	BYTE	0	N/A	
Control Relay Outputs							
12	1	0	Reset energy counters	N/A	N/A	N/A	See note 1
		1	Change to Modbus RTU protocol	N/A	N/A	N/A	See note 2
Binary Counters (Primary; read via Class 0 only)							
20	4	0	Positive watt-hours	UINT32	0 to 99999999 Wh	See note 3	See note 4
		1	Negative watt-hours	UINT32	0 to 99999999 Wh	See note 3	See note 4
		2	Positive var-hours	UINT32	0 to 99999999 varh	See note 3	See note 4
		3	Negative var-hours	UINT32	0 to 99999999 varh	See note 3	See note 4
		4	Total VA-hours	UINT32	0 to 99999999 VAh	See note 3	See note 4
Analog Inputs (Secondary; read via Class 0 only)							
30	5	0	Meter health	SINT16	0 or 1	N/A	0 = OK
		1	Voltage A-N	SINT16	0 to 32767 V	(150/32768)	See note 5
		2	Voltage B-N	SINT16	0 to 32767 V	(150/32768)	See note 5
		3	Voltage C-N	SINT16	0 to 32767 V	(150/32768)	See note 5
		4	Phase voltage A-B	SINT16	0 to 32767 V	(300/32768)	See note 6
		5	Phase voltage B-C	SINT16	0 to 32767 V	(300/32768)	See note 6
		6	Phase voltage C-A	SINT16	0 to 32767 V	(300/32768)	See note 6
		7	Phase A current	SINT16	0 to 32767 A	(10/32768)	See note 7
		8	Phase B current	SINT16	0 to 32767 A	(10/32768)	See note 7
		9	Phase C current	SINT16	0 to 32767 A	(10/32768)	See note 7
		10	Total three-phase real power	SINT16	-32768 to +32767 W	(4500/32768)	
		11	Total three-phase reactive power	SINT16	-32768 to +32767 var	(4500/32768)	
		12	Total three-phase apparent power	SINT16	0 to 32767 VA	(4500/32768)	
		13	Total three-phase power factor	SINT16	-1000 to 1000	0.001	
14	Frequency	SINT16	0 to 9999 Hz	0.01			

Table 5-1: DNP Point Mapping (Sheet 2 of 2)

Object	Var	Point	Description	Format	Range/units	Multiplier	Comments
		15	Maximum average positive three-phase real power demand	SINT16	-32768 to +32767 W	(4500/32768)	
		16	Maximum average positive three-phase reactive power demand	SINT16	-32768 to +32767 var	(4500/32768)	
		17	Maximum average negative three-phase real power demand	SINT16	-32768 to +32767 W	(4500/32768)	
		18	Maximum average negative three-phase reactive power demand	SINT16	-32768 to +32767 var	(4500/32768)	
		19	Maximum average three-phase apparent power demand	SINT16	-32768 to +32767 VA	(4500/32768)	
30	5	20	Phase A current angle	SINT16	-1800 to 1800°	0.1	
		21	Phase B current angle	SINT16	-1800 to 1800°	0.1	
		22	Phase C current angle	SINT16	-1800 to 1800°	0.1	
		23	Phase A-B voltage angle	SINT16	-1800 to 1800°	0.1	
		24	Phase B-C voltage angle	SINT16	-1800 to 1800°	0.1	
		25	Phase C-A voltage angle	SINT16	-1800 to 1800°	0.1	
		26	CT numerator	SINT16	1 to 9999	N/A	See note 8
		27	CT multiplier	SINT16	1, 10, or 100	N/A	
		28	CT denominator	SINT16	1 or 5	N/A	
		29	PT numerator	SINT16	1 to 9999	N/A	See note 9
		30	PT multiplier	SINT16	1, 10, or 100	N/A	
31	PT denominator	SINT16	1 to 9999	N/A			
Internal Indication							
80	1	0	Device restart bit	N/A	N/A	N/A	See note 10

5.2.2 DNP Point Map Notes

1. Responds to Function 5 (direct operate), Qualifier Code 7 or 8, Control Code 3, Count 0, On 1 ms, Off 0 ms ONLY.
2. Responds to Function 6 (direct operate - no acknowledge), Qualifier Code 7, Control Code 3, Count 0, On 1 ms, Off 0 ms ONLY.
3. The multiplier = $10^{(n-d)}$, where n and d are derived from the energy format. n = 0, 3, or 6 per energy format scale and d = number of decimal places.
4. Example: If energy format = 7.2 K and watt-hours counter = 1234567, with n=3 (k-scale) and d = 2 (2 digits after decimal point), then multiplier = $10^{(3-2)} = 10$, so the energy is 1234567×10 Wh, or 12345.67 kWh.
5. Values greater than 150 V secondary read 32767.
6. Values greater than 300 V secondary read 32767.
7. Values greater than 10 A secondary read 32767. For the 1 A model, the multiplier is (2/32768) and values above 2 A secondary read 32767.
8. CT ratio = (numerator \times multiplier) / denominator.
9. PT ratio = (numerator \times multiplier) / denominator.
10. Clear via Function 2 (write), Qualifier Code 0.

5.3 DNP Implementation

5.3.1 Overview

The EPM 6000 meter is capable of using RS485 as the physical layer. This is accomplished by connecting a PC to the meter with the RS485 connection on the back face.

RS485 provides multi-drop network communication capabilities. Multiple meters may be placed on the same bus, allowing for a master device to communicate with any of the other devices. Appropriate network configuration and termination should be evaluated for each installation to insure optimal performance.

The EPM 6000 communicates in DNP 3.0 using the following communications settings: 8 data bits, no parity, and 1 stop bit. The EPM 6000 can be programmed to use several standard baud rates, including: 9600, 19200, 38400, and 57600 bps.

5.3.2 Data Link Layer

The Data Link Layer as implemented on the EPM 6000 is subject to the following considerations.

The control byte contains several bits and a function code. Communications directed to the meter should be primary master messages (DIR = 1, PRM = 1). Responses will be primary non-master messages (DIR = 0, PRM = 1). Acknowledgment will be secondary non-master messages (DIR = 0, PRM = 0).

The EPM 6000 supports all of function codes for DNP 3.0:

- **Reset of Data Link** (function 0): Before confirmed communication with a master device, the data link layer must be reset. This is necessary after a meter has been restarted, either by applying power or reprogramming the meter. The meter must receive a RESET command before confirmed communication may take place. Unconfirmed communication is always possible and does not require a RESET command.
- **User Data** (function 3): After receiving a request for USER DATA, the meter will generate a data link CONFIRMATION, signaling the reception of that request, before the actual request is processed. If a response is required, it will also be sent as UNCONFIRMED USER DATA.
- **Unconfirmed User Data** (function 4): After receiving a request for UNCONFIRMED USER DATA, a response will be sent as UNCONFIRMED USER DATA if required.

DNP 3.0 allows for addresses from 0 to 65534 (0000h to FFFh) for individual device identification, with the address 65535 (FFFFh) defined as an all stations address. Addresses are programmable from 0 to 247 (0000h to 00F7h), and recognize address 65535 (FFFFh) as the all stations address.

5.3.3 Transport Layer

Multiple-frame messages are not allowed for the EPM 6000. Each transport header should indicate it is both the first frame (FIR = 1) and the final frame (FIN = 1)

5.3.4 Application Layer

The application layer contains a header (request or response header, depending on direction) and data.

Application headers contain the *application control field* and the *function code*. For the application control field, multiple-fragment messages are not allowed for EPM 6000. Each application header should indicate it is both the first fragment (FIR = 1) as well as the final fragment (FIN = 1). Application-level confirmation is not used for the EPM 6000.

The following function codes are implemented on the EPM 6000.

- **Read** (function 1): Objects supporting the READ function are Binary Outputs (object 10), Counters (object 20), Analog Inputs (object 30), and Class (object 60). These Objects may be read either by requesting a specific variation available as listed in *DNP Point Mapping* on page 5–10, or by requesting variation 0. A READ request for variation 0 of an object will be fulfilled with the variation listed in the DNP points table.
- **Write** (function 2): The Internal Indications object (object 80), supports the WRITE function.
- **Direct Operate** (function 5): The Control Relay Output object (object 12) supports the DIRECT OPERATE function.
- **Direct Operate - No Acknowledgment** (function 6): the Change to Modbus RTU protocol (object 12, point 1) supports the DIRECT OPERATE - NO ACKNOWLEDGMENT function.
- **Response** (function 129): Application responses from the EPM 6000 use the RESPONSE function.

5.4 DNP Objects and Variations

5.4.1 Description

Application Data contains information about the object and variation, as well as the qualifier and range. The following objects and variations are supported:

- Binary Output Status (object 10, variation 2)
- Control Relay Output Block (object 12, variation 1)
- 32-Bit Binary Counter Without Flag (object 20, variation 4)
- 16-Bit Analog Input Without Flag (object 30, variation 5)
- Class 0 Data (object 60, variation 1)
- Internal Indications (object 80, variation 1)

Read requests for variation 0 will be honored on the Binary Output Status, 32-Bit Binary Counter Without Flag, 16-Bit Analog Input Without Flag, and Class 0 Data variations.

5.4.2 Binary Output Status (Object 10, Variation 2)

The Binary Output Status supports the Read function (function 1). A READ request for Variation 0 will be responded to with Variation 2.

The Binary Output Status is used to communicate the following metered data:

- **Energy Reset State** (point 0): EPM 6000 meters accumulate power generated or consumed over time as hour readings, which measure positive VAh and positive and negative Wh and varh. These readings may be reset using the Control Relay Output object (object 12). This Binary Output Status point reports whether the energy readings are in the process of being reset or if they are accumulating. Normally, readings are being accumulated and the state of this point is read as "0". If the readings are in the process of being reset, the state of this point is read as "1".
- **Change to Modbus RTU Protocol State** (point 1): EPM 6000 meters are capable of switching from the DNP protocol to the Modbus RTU protocol. This enables the user to update the device profile of the meter. This feature does not change the protocol setting, as reset returns the meter to DNP. A status reading of "1" equals open (or de-energized); a reading of "0" equals closed (or energized).

5.4.3 Control Relay Output (Object 12, Variation 1)

The Control Relay Output Block supports the following functions: Direct Operate (function 5) and Direct Operate - No Acknowledgment (function 6).

The Control Relay Output Block is used for the following purposes:

- **Energy Reset** (point 0): EPM 6000 meters accumulate power generated or consumed over time as hour readings, which measure positive VAh and positive and negative Wh and varh. These readings may be reset using Point 0.

The Direct Operate (function 5) function will operate only with the settings of Pulsed ON (Code = 1 of Control Code field) once (Count = 01h) for ON 1 ms and OFF 0 ms.

- **Change to Modbus RTU Protocol** (point 1): EPM 6000 meters are capable of switching from the DNP Protocol to the Modbus RTU Protocol. This enables the user to update the device profile of the meter. This does not change the protocol setting, as a reset returns the meter back to DNP.

The Direct Operate - No Acknowledge (function 6) function will operate only with the settings of Pulsed ON (Code = 1 of the Control Code field) once (Count = 01h) for ON 1 ms and OFF 0 ms.

5.4.4 32-Bit Binary Counter Without Flag (Object 20, Variation 4)

The counters support the Read function (function 1). A read request for Variation 0 will be responded to with Variation 4.

Counters are used to communicate the hour readings measured by the EPM 6000 meter. Refer to *DNP Point Mapping* on page 5–10 for details. These readings may be cleared by using the Control Relay Output Block.

5.4.5 16-Bit Analog Input Without Flag (Object 30, Variation 5)

The analog inputs support the Read function (function 1). A read request for Variation 0 will be responded to with Variation 5.

Refer to *DNP Point Mapping* on page 5–10 for details on the data measured by the analog inputs.

- **Health Check** (point 0): The health check point indicates problems detected by the EPM 6000. A value of zero (0000h) indicates the meter does not detect a problem; non-zero values indicate a detected anomaly.
- **Phase-to-Neutral Voltages** (points 1 to 3): These points are formatted as two's complement fractions. They represent a fraction of a 150 V secondary input. Inputs greater than 150 V secondary will be pinned at 150 V secondary.
- **Phase-to-Phase Voltages** (points 4 to 6): These points are formatted as two's complement fractions. They represent a fraction of a 300 V secondary input. Inputs greater than 300 V secondary will be pinned at 300 V secondary.
- **Phase Currents** (points 7 to 9): These points are formatted as two's complement fractions. They represent a fraction of a 10 A secondary input. Inputs greater than 10 A secondary will be pinned at 10 A secondary.
- **Total Real and Reactive Power** (points 10 and 11): These points are formatted as two's complement fractions. They represent a fraction of 4500 W secondary in normal operation or 3000 W secondary in open delta operation. Inputs above/below ± 4500 or ± 3000 W secondary will be pinned at ± 4500 or ± 3000 W secondary, respectively.
- **Total Apparent Power** (point 12): This point is formatted as a two's complement fraction. It represents a fraction of 4500 W secondary in normal operation or 3000 W secondary in open delta operation. Inputs above/below ± 4500 or ± 3000 W secondary will be pinned at ± 4500 or ± 3000 W secondary, respectively.
- **Power Factor** (point 13): This point is formatted as a two's complement integer. It represents power factors from -1.000 (0FC18h) to $+1.000$ (003E8h). When in open delta operation, the total power factor (point 13) is always zero.

- **Frequency** (point 14): This point is formatted as a two's complement fraction. It represents the frequency as measured on phase A voltage in units of cHz (centiHertz, 1/100 Hz). Inputs below 45.00 Hz are pinned at 0 (0000h), while inputs above 75.00 Hz are pinned at 9999 (270Fh).
- **Maximum Demands of Total Power** (points 15 to 19): These points are formatted as two's complement fractions. They represent a fraction of 4500 W secondary in normal operation or 3000 W secondary in open delta operation. Inputs above/below ± 4500 or ± 3000 W secondary will be pinned at ± 4500 or ± 3000 W secondary, respectively.
- **Phase Angles** (points 20 to 25): These points are formatted as two's complement integers. They represent angles from -180.00 (0F8F8h) to $+180.00$ (00708h).
- **CT and PT Ratios** (points 26 to 31): These points are formatted as two's complement integers. They can be used to convert from units in terms of the secondary of a CT or PT into units in terms of the primary of a CT or PT. The ratio of numerator divided by denominator is the ratio of primary to secondary. The EPM 6000 typically uses full scales relating primary current to 5 A and primary voltage to 120 V. However, these full scales can range from mAs to thousands of kAs, or mVs to thousands of kVs. Example settings are as follows:

CT example settings:

200 A: Set the **ct-n** value for "200" and the **ct-s** value for "1".
 800 A: Set the **ct-n** value for "800" and the **ct-s** value for "1".
 2000 A: Set the **ct-n** value for "2000" and the **ct-s** value for "1".
 10000 A: Set the **ct-n** value for "1000" and the **ct-s** value for "10".

PT example settings:

120 V (reads 14400 V):
 Set the **pt-n** value to "1440", **pt-d** to "120", and **pt-s** to "10".
 69 V (reads 138000 V):
 Set the **pt-n** value to "1380", **pt-d** to "69", and **pt-s** to "100".
 115 V (reads 345000 V):
 Set the **pt-n** value to "3450", **pt-d** to "115", and **pt-s** to "100".

5.4.6 Class 0 Data (Object 60, Variation 1)

The Class 0 Data object supports the Read (function 1) function. A request for Class 0 Data from an EPM 6000 returns three object headers. Specifically, it returns 16-Bit Analog Input Without Flags (object 30, variation 5) points 0 to 31, followed by 32-Bit Counters Without Flags (object 20, variation 4) points 0 to 4, followed by Binary Output Status (object 10, variation 2), points 0 to 1. There is NO Object 1.

A request for Object 60, Variation 0 will be treated as a request for Class 0 Data.

5.4.7 Internal Indications (Object 80, Variation 1)

The Internal Indications object support the Write function (function 2). Internal Indications may be indexed by Qualifier Code 0.

The Device Restart (point 0) bit is set whenever the meter has reset. The polling device may clear this bit by writing (function 2) to Object 80, Point 0.



EPM 6000 Multi-function Power Metering System

Chapter 6: Miscellaneous

6.1 Navigation Maps

6.1.1 Introduction

The EPM 6000 meter can be configured and a variety of functions performed using the buttons on the meter faceplate. An overview of the elements and buttons on the faceplate can be found in Chapter 4. The meter can also be programmed using software such as GE Communicator.

The navigation maps show in detail how to move from one screen to another and from one display mode to another using the buttons on the meter faceplate. All display modes will automatically return to operating mode after 10 minutes of no user activity.

6.1.2 Main Menu Screens

The main menu navigation map is shown below.

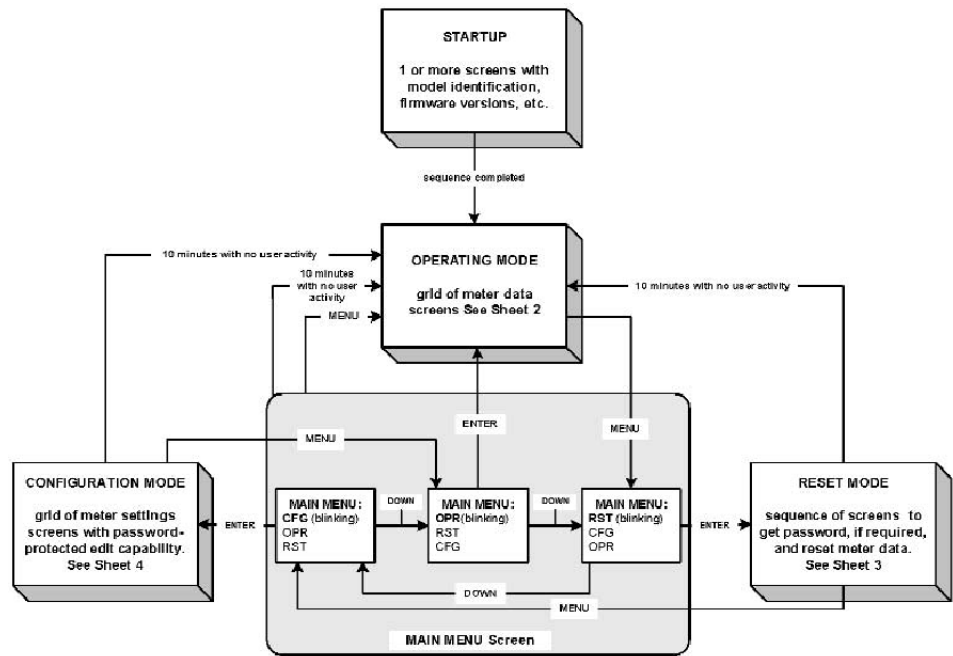

MAIN MENU Screen scrolls through 3 choices, showing all 3 at once. The top choice is always the active one, which is indicated by the blinking legend.

BUTTONS	
MENU	Returns to MAIN MENU from any screen in any mode.
ENTER	Indicates acceptance of the current screen and advances to the next one.
DOWN, RIGHT	Navigation and Edit buttons
Navigation:	No digits or legends are blinking. On a menu, DOWN advances to the next menu selection, RIGHT does nothing. In a grid of screens, DOWN advances to the next row, RIGHT advances to the next column. Row, columns and menus all navigate circularly.
Editing:	A digit or legend is blinking to indicate that it is eligible for change. When a digit is blinking, DOWN increases the digit value, RIGHT moves to the next digit. When a legend is blinking, either button advances to the next choice legend.

				— button →
--	--	--	--	------------

FIGURE 6–1: Main Menu Navigation

6.1.3 Operating Mode Screens

The operating mode navigation map is shown below.

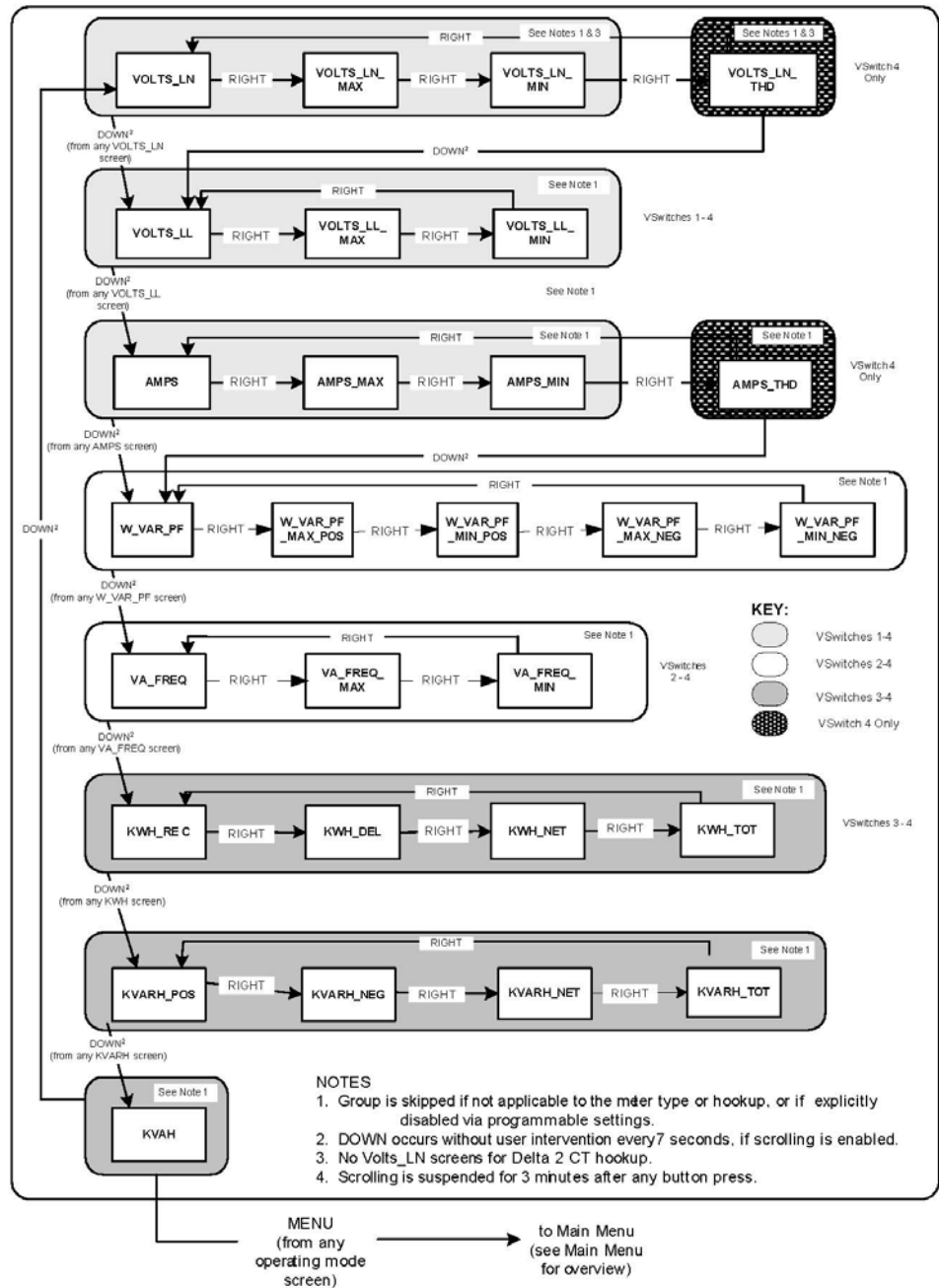

FIGURE 6-2: Operating Mode Navigation

6.1.4 Reset Mode Screens

The reset mode navigation map is shown below.

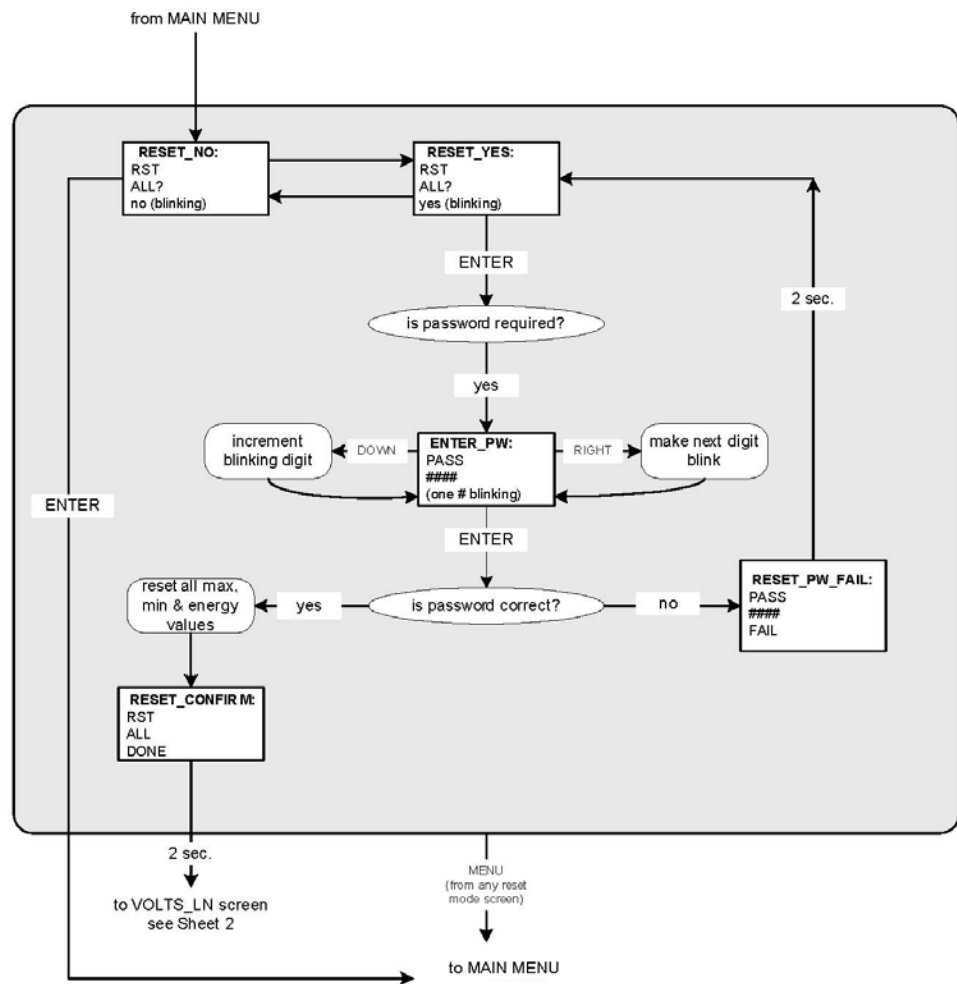

FIGURE 6–3: Reset Mode Navigation

6.2 Revision History

6.2.1 Release Dates

Table 6-1: Release Dates

MANUAL	GE PART NO.	EPM 6000 REVISION	RELEASE DATE
GEK-106558	1601-0215-A1	1.0x	24 January 2004
GEK-106558A	1601-0215-A2	1.0x	08 April 2005
GEK-106558B	1601-0215-A3	1.0x	06 September 2005
GEK-106558C	1601-0215-A4	1.0x	14 February 2007

6.2.2 Changes to the Manual

Table 6-2: Major Updates for 1601-0215-A4

SECT (A3)	SECT (A4)	CHANGE	DESCRIPTION
Title	Title	Update	Manual part number to 1601-0215-A4
1.4.2	1.4.2	Update	%THD Accuracy Changed
4.1.5	4.1.5	Update	Fig 4-3 updated
4.3.5	4.3.5	Update	PT Settings example values changed to be more reflective of actual customer values
5.4.5	5.4.5	Update	PT Settings example values changed to align with above values
6.1.1	6.1.1	Update	Added mention of GE Communicator software.

Table 6-3: Major Updates for 1601-0215-A3

PAGE (A2)	PAGE (A3)	CHANGE	DESCRIPTION
Title	Title	Update	Manual part number to 1601-0215-A3
3-4	3-4	Update	Updated ELECTRICAL INSTALLATION section
3-16	3-16	Update	Updated RS485 COMMUNICATIONS INSTALLATION diagram

Table 6-4: Major Updates for 1601-0215-A2

PAGE (A1)	PAGE (A2)	CHANGE	DESCRIPTION
Title	Title	Update	Manual part number to 1601-0215-A2
2-3	2-3	Update	Updated ORDER CODES section
2-3	---	Delete	Removed ACCESSORIES section
2-4	2-4	Update	Updated INPUTS/OUTPUTS specifications
---	3-13	Add	Added CURRENT ONLY MEASUREMENT (THREE-PHASE) section
---	3-14	Add	Added CURRENT ONLY MEASUREMENT (DUAL-PHASE) section
---	3-15	Add	Added CURRENT ONLY MEASUREMENT (SINGLE-PHASE) section
4-9	4-9	Update	Updated CONFIGURING THE CT SETTING section
4-10	4-10	Update	Updated CONFIGURING THE PT SETTING section
---	5-7	Add	Added DNP COMMUNICATIONS section

6.3 Warranty

6.3.1 GE Multilin Warranty

General Electric Multilin (GE Multilin) warrants each device it manufactures to be free from defects in material and workmanship under normal use and service for a period of 24 months from date of shipment from factory.

In the event of a failure covered by warranty, GE Multilin will undertake to repair or replace the device providing the warrantor determined that it is defective and it is returned with all transportation charges prepaid to an authorized service centre or the factory. Repairs or replacement under warranty will be made without charge.

Warranty shall not apply to any device which has been subject to misuse, negligence, accident, incorrect installation or use not in accordance with instructions nor any unit that has been altered outside a GE Multilin authorized factory outlet.

GE Multilin is not liable for special, indirect or consequential damages or for loss of profit or for expenses sustained as a result of a device malfunction, incorrect application or adjustment.

For complete text of Warranty (including limitations and disclaimers), refer to GE Multilin Standard Conditions of Sale.

Index

A

ACCURACY 1-7, 4-4

B

BAUD RATE 4-14, 4-15

BLONDELL'S THEOREM 2-5

C

CATALOG NUMBERS 1-5

CHANGES TO MANUAL 6-6, 6-7

CHANGING SETTINGS 4-9

COMMUNICATIONS

description 3-19

IrDA 3-19

memory map 5-1, 5-2

Modbus 5-1

RS485 3-19

settings 4-14

specifications 1-7

COMPLIANCE 1-8

CONFIGURATION MODE

changing settings 4-9

description 4-5

navigation 6-5

programming 4-10

CONNECTION SETTING 4-13

CT SETTING 4-11

CURRENT INPUTS

connections 1-3

settings 4-11

specifications 1-6

D

DELTA CONNECTION

3-wire, 2 PTs, 3 CTs 3-15

3-wire, no PTs, 3 CTs 3-14

background 2-4

phasors 2-4, 2-5

setting 4-13

DEMAND 2-10

DIMENSIONS 1-7, 3-1

DOWN BUTTON 4-2

E

ENERGY 2-8, 2-12

ENTER BUTTON 4-2

ENVIRONMENTAL SPECIFICATIONS	1-7
------------------------------------	-----

F

FACEPLATE BUTTONS	4-2
FACEPLATE ELEMENTS	4-2
FEATURES	1-1
FUSES	3-8

G

GROUND CONNECTION	3-8
-------------------------	-----

I

INSTALLATION	
CT leads pass-through	3-6
CT leads terminated to meter	3-6
electrical	3-5
mechanical	3-1
precautions	3-5
quick connect	3-7
voltage connections	3-7
wiring	3-9
IRDA	
communications paths	3-19
description	3-19

L

LOAD BAR	4-3
----------------	-----

M

MAIN MENU	
description	4-6
navigation	6-2
MEASURED VALUES	1-4
MEMORY MAP	5-1
MENU BUTTON	4-2
METER ADDRESS	4-14
METERING	1-4, 1-6
MODBUS	
memory map	5-1, 5-2
settings	4-15
MOUNTING	
ANSI panel	3-2
DIN panel	3-3
panel cutouts	3-2

N

NAVIGATION MAPS	6-1
-----------------------	-----

O

OPERATING MODE	
navigation.....	6-3
programming.....	4-17
ORDER CODES.....	1-5

P

PANEL CUTOUTS.....	3-2
PASSWORD ENTRY.....	4-7, 4-8
POWER.....	2-8
POWER FACTOR.....	2-13
POWER QUALITY.....	2-17
POWER SUPPLY	
connection.....	3-8
specifications.....	1-6
PROTOCOL.....	4-16
PT SETTING.....	4-12

Q

QUICK CONNECT.....	3-7
--------------------	-----

R

REGISTER MAP.....	5-1
RESET MODE	
description.....	4-6
navigation.....	6-4
REVENUE METERING.....	4-4
REVISION HISTORY.....	6-6
RIGHT BUTTON.....	4-2
RS485	
specifications.....	1-7
wiring.....	3-19

S

SCROLL FEATURE.....	4-9
SPECIFICATIONS.....	1-6
STARTUP.....	4-5

T

TYPE TESTING.....	1-8
-------------------	-----

U

UTILITY PEAK DEMAND.....	1-3
--------------------------	-----

V

VOLTAGE INPUTS	
connections.....	3-8

description.....	1-3
settings	4-12
specifications	1-6

W

WARRANTY	6-8
WATT-HOUR ACCURACY TEST	4-4
WAVEFORM CAPTURE	2-16
WIRING	
current-only, dual-phase.....	3-17
current-only, single-phase.....	3-18
current-only, three-phase.....	3-16
delta	3-14, 3-15
description.....	3-9
wye.....	3-10, 3-11, 3-12, 3-13
WYE CONNECTION	
4-wire, 2 PTs, 3 CTs, 2.5 element.....	3-13
4-wire, 3 PTs, 3 CTs, 3 element	3-12
4-wire, no PTs, 3 CTs, 2.5 element.....	3-11
4-wire, no PTs, 3 CTs, 3 element.....	3-10
background.....	2-2
phasors	2-3
setting.....	4-13

Free Manuals Download Website

<http://myh66.com>

<http://usermanuals.us>

<http://www.somanuals.com>

<http://www.4manuals.cc>

<http://www.manual-lib.com>

<http://www.404manual.com>

<http://www.luxmanual.com>

<http://aubethermostatmanual.com>

Golf course search by state

<http://golfingnear.com>

Email search by domain

<http://emailbydomain.com>

Auto manuals search

<http://auto.somanuals.com>

TV manuals search

<http://tv.somanuals.com>