



Range Hoods

Safety Information 2, 3

Operating/Care and Cleaning Instructions

Charcoal Filter 5

Grease Filter 4

Hood Light 5

Hood Surfaces 5

Controls 4

Installation Instructions . . . 6-14

Consumer Support

Consumer Support . . . Back Cover

Warranty 15

Owner's Manual and Installation Instructions

- JN327-Recirculation only*
- JV338*-Vent options only*
- JV347*-Vent & Recirculation options*
- JV367*-Vent & Recirculation options*
- RN328-Recirculation only*



Write the model and serial numbers here:

Model # _____

Serial # _____

You can find them on a label on the back wall of the hood.



IMPORTANT SAFETY INFORMATION. READ ALL INSTRUCTIONS BEFORE USING.



SAFETY PRECAUTIONS

WARNING — TO REDUCE THE RISK OF FIRE, ELECTRIC SHOCK OR INJURY TO PERSONS, OBSERVE THE FOLLOWING:

- A. Use this unit only in the manner intended by the manufacturer. If you have questions, contact the manufacturer.
- B. Before servicing or cleaning unit, switch power off at service panel and lock the service disconnecting means to prevent power from being switched on accidentally. When the service disconnecting means cannot be locked, securely fasten a prominent warning device, such as a tag, to the service panel.
- C. Do not use this unit with any solid-state speed control device.
- D. If using a cord connection kit, use only with range hood cord-connection kit JXHC1 that has been investigated and found acceptable for use with this model range hood.
- E. This unit must be grounded.

CAUTION — FOR GENERAL VENTILATING USE ONLY. DO NOT USE TO EXHAUST HAZARDOUS OR EXPLOSIVE MATERIALS AND VAPORS.

WARNING — TO REDUCE THE RISK OF INJURY TO PERSONS IN THE EVENT OF A RANGE TOP GREASE FIRE, OBSERVE THE FOLLOWING*:

- A. SMOTHER FLAMES with a close-fitting lid, cookie sheet or metal tray, then turn off the burner. BE CAREFUL TO PREVENT BURNS. If the flames do not go out immediately, EVACUATE AND CALL THE FIRE DEPARTMENT.
- B. NEVER PICK UP A FLAMING PAN— You may be burned.
- C. DO NOT USE WATER, including wet dishcloths or towels—a violent steam explosion will result.
- D. Use an extinguisher ONLY if:
 1. You know you have a Class ABC extinguisher, and you already know how to operate it.
 2. The fire is small and contained in the area where it started.
 3. The fire department is being called.
 4. You can fight the fire with your back to an exit.

* Based on "Kitchen Firesafety Tips" published by NFPA.

WARNING — TO REDUCE THE RISK OF A RANGE TOP GREASE FIRE:

- A. Never leave surface units unattended at high settings. Boilovers cause smoking and greasy spillovers that may ignite. Heat oils slowly on low or medium settings.
- B. Always turn hood ON when cooking on high heat or when flambeing food (i.e. Crepes Suzette, Cherries Jubilee, Peppercorn Beef Flambe).
- C. Clean ventilating fans frequently. Grease should not be allowed to accumulate on fan or filter.
- D. Use proper pan size. Always use cookware appropriate for the size of the surface element.

WARNING — TO REDUCE THE RISK OF FIRE, ELECTRIC SHOCK OR INJURY TO PERSONS, OBSERVE THE FOLLOWING:

- A. Installation work and electrical wiring must be done by qualified person(s) in accordance with all applicable codes and standards, including fire-rated construction.
- B. Sufficient air is needed for proper combustion and exhausting of gases through the flue (chimney) of fuel burning equipment to prevent back drafting. Follow the heating equipment manufacturer's guideline and safety standards such as those published by the National Fire Protection Association (NFPA), the American Society for Heating, Refrigeration and Air Conditioning Engineers (ASHRAE) and the local code authorities.
- C. When cutting or drilling into wall or ceiling, do not damage electrical wiring and other hidden utilities.
- D. Ducted fans must always be vented to the outdoors.

WARNING — TO REDUCE THE RISK OF FIRE, USE ONLY METAL DUCTWORK.

- Do not attempt to repair or replace any part of your hood unless it is specifically recommended in this guide. All other servicing should be referred to a qualified technician.



READ AND FOLLOW THIS SAFETY INFORMATION CAREFULLY.

READ AND SAVE THESE INSTRUCTIONS

INSTRUCTIONS DE SÉCURITÉ IMPORTANTES. LISEZ TOUTES LES INSTRUCTIONS AVANT D'UTILISER.



PRÉCAUTIONS EN MATIÈRE DE SÉCURITÉ

AVERTISSEMENT — POUR RÉDUIRE LE RISQUE D'INCENDIE, DE SECOURS ÉLECTRIQUE OU DE BLESSURE CORPORELLE, OBSERVEZ LES PRÉCAUTIONS SUIVANTES :

- A. N'utilisez cet appareil que de la manière prévue par le fabricant. Si vous avez des questions, appelez le fabricant.
- B. Avant de réparer ou de nettoyer votre appareil, débranchez le courant au niveau du panneau de service et verrouillez les mécanismes de débranchement de service pour éviter tout branchement accidentel au courant. Si vous ne pouvez pas verrouiller les mécanismes de débranchement de service, attachez soigneusement un avertissement bien visible, comme une étiquette, au panneau de service.
- C. N'utilisez jamais cet appareil avec un mécanisme de réglage de la vitesse à semi-conducteurs.
- D. Si vous utilisez l'ensemble de cordon de raccordement, utilisez seulement avec l'ensemble de cordon de raccordement pour hotte JXHC1. Suite à un examen technique, l'article JXHC1 s'est avéré compatible avec ce modèle de hotte.
- E. Cet appareil doit être bien mis à la terre.

ATTENTION — UNIQUEMENT À USAGE DE VENTILATION GÉNÉRALE. N'UTILISEZ JAMAIS POUR L'ÉCHAPPEMENT DE MATIÈRES ET DE VAPEURS EXPLOSIVES.

AVERTISSEMENT — POUR RÉDUIRE LE RISQUE DE BLESSURE CORPORELLE SI DE LA GRAISSE PREND FEU SUR LA SURFACE DE CUISSON DU FOUR, SUIVEZ LES INSTRUCTIONS SUIVANTES* :

- A. ÉTOUFFEZ LES FLAMMES avec un couvercle qui convient, une tôle à biscuits ou un plateau en métal, puis éteignez le brûleur. FAITES BIEN ATTENTION DE NE PAS VOUS BRÛLER. Si les flammes ne s'éteignent pas immédiatement, SORTEZ ET APPELEZ LES POMPIERS.
- B. NE DÉPLACEZ JAMAIS UNE CASSEROLLE QUI FLAMBE – Vous pouvez vous brûler.
- C. N'UTILISEZ JAMAIS D'EAU, en particulier de serviette ou de chiffon mouillé – il se produira une explosion violente de vapeur brûlante.
- D. N'UTILISEZ UN EXTINCTEUR que si :
 1. Vous avez un extincteur de classe ABC et vous savez comment l'utiliser;
 2. Le feu est réduit et confiné à l'endroit où il a commencé;
 3. Vous avez déjà appelé les pompiers;
 4. Vous combattez les flammes en tournant le dos à une sortie.

* Basé sur l'ouvrage intitulé «Kitchen Fire Safety Tips» publié par la NFPA.

AVERTISSEMENT — RÉDUISEZ LE RISQUE D'UN FEU DE GRAISSE SUR LA SURFACE DE CUISSON DU FOUR :

- A. Ne laissez jamais sans surveillance les unités de cuisson de surface à une température élevée. Le bouillonnement occasionne des débordements fumants et grasseux qui peuvent prendre feu. Chauffez à feu doux les substances huileuses, avec un réglage bas ou moyen.
- B. ALLUMEZ toujours la hotte en cas de cuisson à feu élevé ou lorsque vous faites flamber des aliments (par exemple, crêpes Suzette, cerises jubilé, bœuf au poivre flambé).
- C. Nettoyez les mécanismes de ventilation fréquemment. Il ne faut pas permettre une accumulation de graisse sur le ventilateur ou sur le filtre.
- D. Utilisez une casserole de bonne taille. Utilisez toujours un ustensile de cuisine qui convienne au diamètre de l'élément de cuisson.

AVERTISSEMENT — POUR RÉDUIRE LE RISQUE D'INCENDIE, DE SECOURS ÉLECTRIQUE OU DE BLESSURE CORPORELLE, OBSERVEZ LES PRÉCAUTIONS SUIVANTES :

- A. Vous devez faire exécuter tous les travaux d'installation et de câblage électrique par une personne qualifiée, conformément à tous les codes et les normes en vigueur, en particulier ceux de construction relatifs aux incendies.
- B. Vous devez assez d'air pour avoir une bonne combustion et permettre l'évacuation des gaz par le conduit de cheminée du matériel de combustion du carburant, afin d'éviter tout retour d'air. Suivez les directives du fabricant de matériel de combustion et les normes de sécurité comme celles publiées par la National Fire Protection Association (NFPA), l'American Society for Heating, Refrigeration and Air Conditioning Engineers (ASHRAE), ainsi que les modalités des codes locaux.
- C. Si vous faites un trou ou une ouverture dans un mur ou un plafond, n'endommagez pas les fils électriques et les autres installations cachées de service public.
- D. Vous devez toujours alimenter les ventilateurs dans les conduits en air en provenance de l'extérieur.

AVERTISSEMENT — POUR RÉDUIRE LE RISQUE D'INCENDIE, N'UTILISEZ QUE DES CONDUITS EN MÉTAL.

- N'essayez jamais de remplacer ou de réparer un élément de votre hotte si le présent manuel ne le recommande pas expressément. Tout autre entretien doit être effectué par un technicien qualifié.



LISEZ ET SUIVEZ ATTENTIVEMENT CES INSTRUCTIONS.

LISEZ ET CONSERVEZ CES INSTRUCTIONS

Using the hood controls.

Throughout this manual, features and appearance may vary from your model.

Control Knobs (on some models)

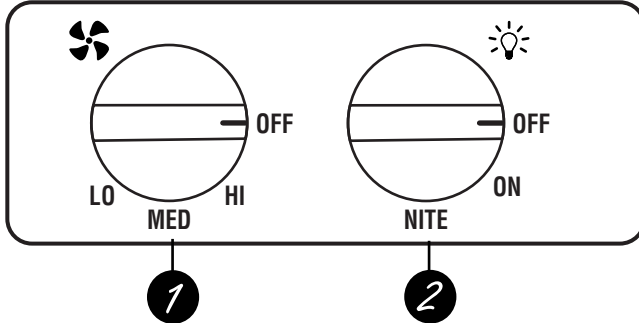

1 FAN Control

Turn to **HI**, **MED** or **LO** as needed.

Continuous use of the fan system while cooking helps keep the kitchen comfortable and less humid. It also reduces cooking odors and soiling moisture that create a frequent need for cleaning.

2 LIGHT Control

Turn to **ON** while cooking or to **NITE** for use as a night light.

Switch Pad Controls (on some models)

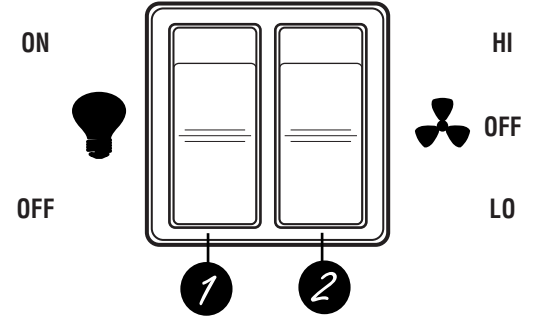

1 LIGHT Control

Press the pad at the top to turn the light **ON**.

2 FAN Control

Press the pad at the top to turn the fan on **HI** and at the bottom to turn it on **LO**. The center position is **OFF**.

Continuous use of the fan system while cooking helps keep the kitchen comfortable and less humid. It also reduces cooking odors and soiling moisture that create a frequent need for cleaning.

Care and cleaning of the vent hood.

Be sure electrical power is off and all surfaces are cool before cleaning or servicing any part of the vent hood.

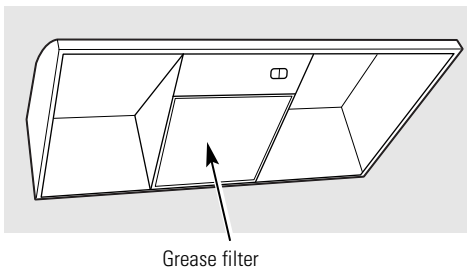

Reusable Metal Grease Filter—Ducted Installations Only

The efficiency of your hood depends on a clean filter. Frequency of cleaning depends on hood use and the type of cooking you do. **However, the grease filter should be cleaned at least once a month.**

To remove:

Pull down on the center of the front edge of the filter. The filter will then slip out of the retaining tabs on the back.

To replace:

Slip the back edge of the filter into the retaining tabs and push the front edge up until it snaps into place.

To clean:

Soak and then agitate it in a hot water and detergent solution. Light brushing can be used to remove embedded dirt. Rinse, shake and let it dry before replacing.

NEVER OPERATE THE HOOD WITHOUT THE FILTER IN PLACE.

With careful handling, the metal filter will last for years. If a new replacement filter becomes necessary, order the part from your dealer. Order genuine GE part number **WB02X8391**.

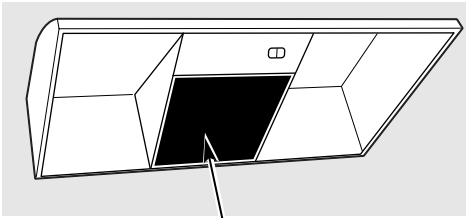

Replaceable charcoal filter

NOTE: DO NOT rinse, or put charcoal filters in an automatic dishwasher.

Charcoal Filter—Recirculating Installations Only

The charcoal filter cannot be cleaned. It must be replaced. Order filter no. WB02X10700. Replacement filters can be ordered from your GE supplier.

If the hood is not vented to the outside, the air will be recirculated through a disposable charcoal filter that helps remove smoke and odors. The charcoal filter should be replaced after 6 to 12 months (depending on hood usage).

To remove:

Pull down on the center of the front edge of the filter. The filter will then slip out of the retaining tabs on the back.

To replace:

Slip the back edge of the filter into the retaining tabs and push the front edge up until it snaps into place.

Stainless Steel Surfaces (on some models)

Do not use a steel-wool pad; it will scratch the surface.

To clean the stainless steel surface, use warm sudsy water or a stainless steel cleaner or polish. Always wipe the surface in the direction of the grain. Follow the cleaner instructions for cleaning the stainless steel surface.

To inquire about purchasing stainless steel appliance cleaner or polish, or to find the location of a dealer nearest you, please call our toll-free number:

National Parts Center

800.626.2002

ge.com

Painted Surfaces (on some models)

Do not use steel-wool pads or other abrasive cleaners. They will scratch the surface.

Clean grease-laden surfaces of the hood frequently. To clean the hood surface, use a hot, damp cloth with a mild detergent suitable for painted surfaces. About one tablespoon of ammonia may be added to the water. Use a clean, hot, damp cloth to remove soap. Dry with a dry, clean cloth.

NOTE: When cleaning, take care not to come in contact with filters and other non-enameled surfaces.

CAUTION: When cleaning the hood surfaces, be certain that you do not touch the light bulb with moist hands or cloth. A warm or hot light bulb may break if touched with a moist surface. Always let the light bulb cool completely before cleaning around it.

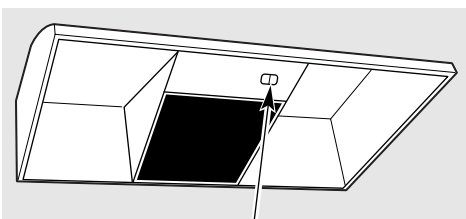

Light cover

Hood Light

CAUTION: Let the light bulb cool completely before removing. A warm or hot bulb may break if touched with a moist cloth or hand.

Remove the bulb and replace with an ordinary screw-base light bulb, **not more than 60 watts.**

To remove the light cover (on some models):

- Press the sides with two fingers until the side prongs are released.
- Lift the light cover and slide it toward you in one motion.

To replace the light cover:

- Insert the prong located at the end of the cover into the top opening.
- Gently push the cover up and press the sides to fit the side prongs into the side openings.
- Release and the cover will lock in position.

Installation Instructions

Range Hood

Questions? Call 800.GE.CARES (800.432.2737) or Visit our Website at: ge.com

BEFORE YOU BEGIN

Read these instructions completely and carefully.

- **IMPORTANT** — Save these instructions for local inspector's use.
- **IMPORTANT** — Observe all governing codes and ordinances.
- **Note to Installer** — Be sure to leave these instructions with the Consumer.
- **Note to Consumer** — Keep these instructions for future reference.
- **Skill level** — Installation of this appliance requires basic mechanical and electrical skills.
- **Completion time** — 30 minutes–3 hours
- Proper installation is the responsibility of the installer.
- Product failure due to improper installation is not covered under the Warranty.

FOR YOUR SAFETY:

WARNING — Before beginning the installation, switch power off at service panel and lock the service disconnecting means to prevent power from being switched on accidentally. When the service disconnecting means cannot be locked, securely fasten a prominent warning device, such as a tag, to the service panel.

OPTIONAL POWER CORD KIT JXHC1

An optional Power Cord Connection Kit, model JXHC1, is available at extra cost from your GE supplier for installation using a standard 3-prong, grounded wall outlet. Follow the Installation Instructions packed with the kit to connect the power cord to the range hood.

DUCTWORK REQUIREMENTS

NOTE: Read the ductwork sections only if you do not have existing ductwork. If you have existing ductwork, skip to the "Damage" section and proceed.

The venting system must exhaust to the outside.

This hood can be vented vertically through upper cabinets or horizontally through an outside wall. Ductwork is not included.

Exhaust connection:

The hood exhaust has been designed to mate with standard 3¼" x 10" rectangular ducting or 7" diameter round ducting.

If a 6" round duct is required, a rectangular-to-round transition adaptor must be used*. **Do not use less than a 6" diameter duct.**

Maximum duct length:

For satisfactory air movement, the total duct length of a 3¼" x 10" rectangular, 6" or 7" diameter round duct **should not exceed 65 equivalent feet. See the WORKSHEET-CALCULATE TOTAL EQUIVALENT DUCTWORK LENGTH section.**

NOTE: It is important that ducting be installed using the most direct route and with as few elbows as possible. This ensures clear venting of exhaust and helps prevent blockages. **Also, make sure dampers swing freely and nothing is blocking the ducts.**











Elbows, transitions, wall and roofcaps, etc., present additional resistance to airflow and are equivalent to a section of straight duct longer than their actual physical size. When calculating the total duct length, add the equivalent lengths of all transitions and adaptors plus the length of all straight duct sections. The charts on the following pages show you how to calculate total equivalent ductwork length using the approximate feet of equivalent length of some typical ducts.













* **IMPORTANT:** If a rectangular-to-round transition adaptor is used, the bottom corners of the damper will have to be cut to fit, using the tin snips, in order to allow free movement of the damper. Equivalent lengths of duct pieces are based on actual tests and reflect requirements for good venting performance with any hood.

Installation Instructions

WORKSHEET—CALCULATE TOTAL EQUIVALENT DUCTWORK LENGTH

DUCT PIECES		EQUIVALENT LENGTH	NUMBER USED	=	TOTAL
	3/4" x 10" Rect., straight	1 Ft.	x ()	=	Ft.
	7" Round, straight	1 Ft.	x ()	=	Ft.
	6" Round, straight	1 Ft.	x ()	=	Ft.
	3/4" x 10" Rect. 90° elbow	14 Ft.	x ()	=	Ft.
	3/4" x 10" Rect. 45° elbow	8 Ft.	x ()	=	Ft.
	3/4" x 10" Rect. 90° flat elbow	33 Ft.	x ()	=	Ft.
	3/4" x 10" Rect. wall cap with damper	24 Ft.	x ()	=	Ft.
		(18 ft. w/o damper)	x ()	=	Ft.
	3/4" x 10" Rect. to 6" round transition	2 Ft.	x ()	=	Ft.
	3/4" x 10" Rect. to 6" round transition 90° elbow	4 Ft.	x ()	=	Ft.
	6" Round, 90° elbow	12 Ft.	x ()	=	Ft.
	6" Round, 45° elbow	7 Ft.	x ()	=	Ft.
Subtotal column 1				=	Ft.

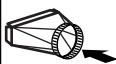
MAXIMUM DUCT LENGTH: For satisfactory air movement, the total duct length of a 3/4" x 10" rectangular, 6" or 7" diameter round duct **should not exceed 65 equivalent feet.**

DUCT PIECES		EQUIVALENT LENGTH	NUMBER USED	=	TOTAL
	6" Round wall cap with damper	24 Ft.	x ()	=	Ft.
		(18 ft. w/o damper)	x ()	=	Ft.
	6" Round roof cap	33 Ft.	x ()	=	Ft.
	6" Round to 3/4" x 10" rect. transition	2 Ft.	x ()	=	Ft.
	6" Round to 3/4" x 10" rect. transition 90° elbow	4 Ft.	x ()	=	Ft.
	7" Round, 90° elbow	14 Ft.	x ()	=	Ft.
	7" Round, 45° elbow	9 Ft.	x ()	=	Ft.
	7" Round wall cap with damper	28 Ft.	x ()	=	Ft.
		(21 ft. w/o damper)	x ()	=	Ft.
	7" Round roof cap	39 Ft.	x ()	=	Ft.
	7" Round to 3/4" x 10" rect. transition	1 Ft.	x ()	=	Ft.
	7" Round to 3/4" x 10" rect. transition, 90° elbow	5 Ft.	x ()	=	Ft.
Subtotal column 2				=	Ft.
Subtotal column 1				=	Ft.
Total ductwork				=	Ft.

Installation Instructions

DAMAGE – SHIPMENT/INSTALLATION

- If the unit is damaged in shipment, return the unit to the store in which it was bought for repair or replacement.
- If the unit is damaged by the customer, repair or replacement is the responsibility of the customer.
- If the unit is damaged by the installer (if other than the customer), repair or replacement must be made by arrangement between customer and installer.

MOUNTING SPACE

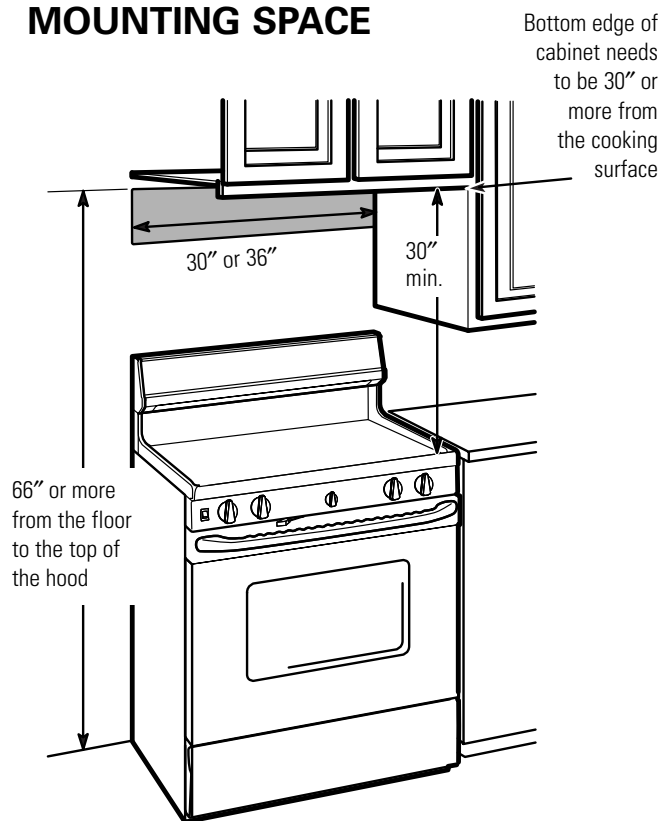





NOTES:

- This range hood is for installation over ranges or cooktops up to 36" wide.
- If you are going to vent your range hood to the outside, see the "Ducting Requirements" section for exhaust duct preparation.

TOOLS YOU WILL NEED

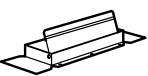

PARTS INCLUDED

PART		QUANTITY
	Grease Filter only (JV338)	1
	Charcoal Filter only (JN327 and RN328)	1
	Grease Filter and Charcoal Filter (JV347 and JV367)	2
	Mounting Screws (8 - 18 x 3/4 Phillips pan head)	4
	Exhaust Adaptor (for 3/4" x 10" rect. venting)	1
	Exhaust Adaptor Screw (8 - 18 x 3/8 Phillips pan head or hex head)	1

Installation Instructions

1 CHOOSE VENT OPTION

Determine the vent option that your installation will require and that is available for your model from the below choices.

IMPORTANT: If the hood is to be installed in a recirculating, non-vented ductless manner, do not knock out any vent openings in the hood. Only an electrical access hole will be knocked out of the hood.

A Outside top exhaust (Vertical duct-3 $\frac{1}{4}$ " x 10" Rectangular)

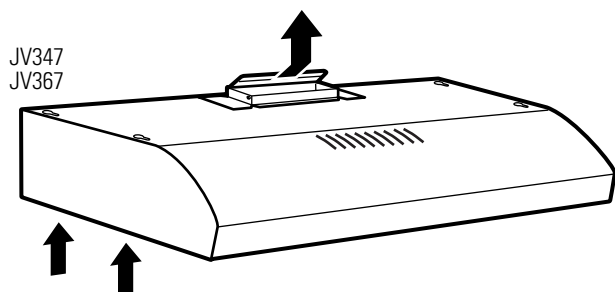
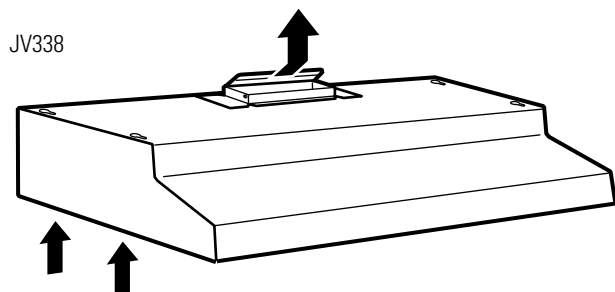

C Outside rear exhaust (Horizontal duct-3 $\frac{1}{4}$ " x 10" Rectangular)

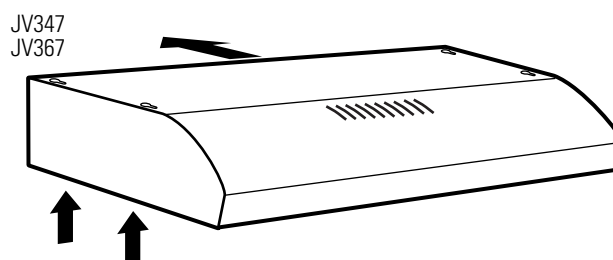
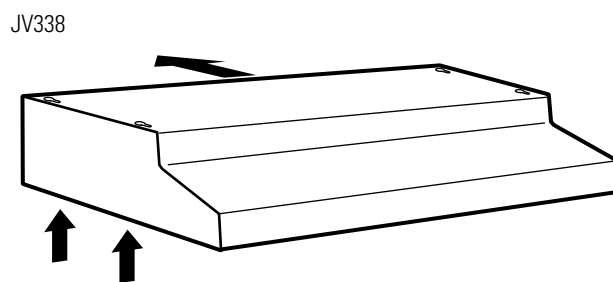

B Outside top exhaust (Vertical duct-7" Round)

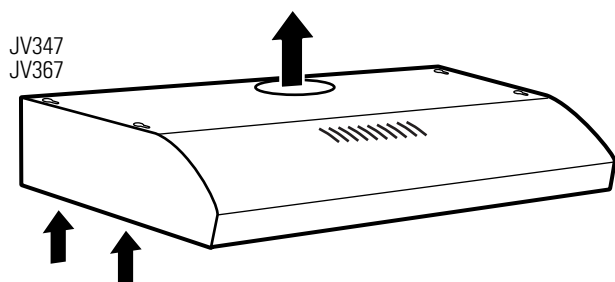
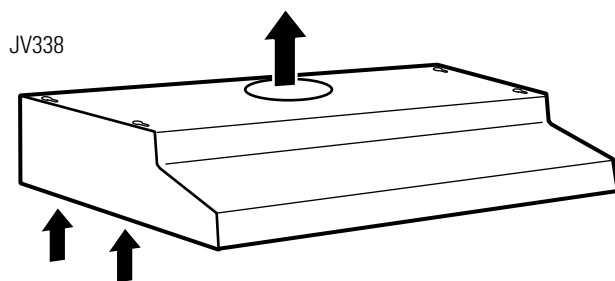

D Recirculating (non-vented/ductless)

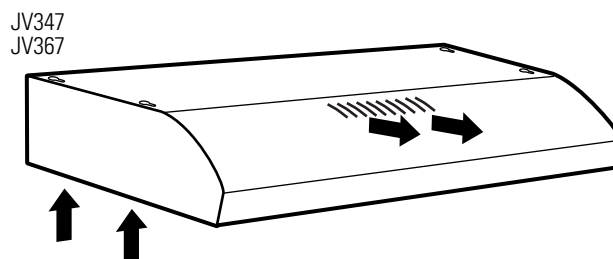
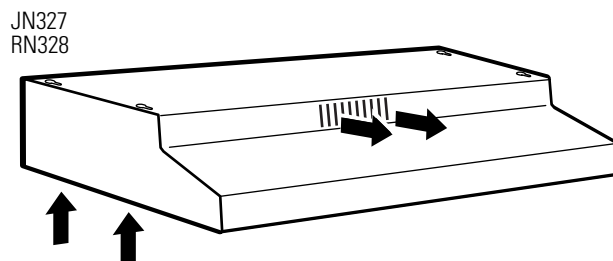

Installation Instructions

2 REMOVE EXHAUST ADAPTOR

If exhausting/venting using the 3/4" x 10" rectangular duct—optional for JV338, JV347 and JV367 models only:

Remove the exhaust adaptor from the inside of the hood. Set it aside along with its mounting screws.

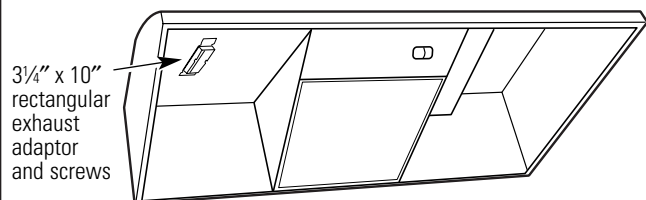

3 REMOVE FILTER

Remove the shipping tape holding the **metal grease filter** in place. Pull down on the center of the front edge of the filter. The filter will then slip out of the retaining tabs on the back.

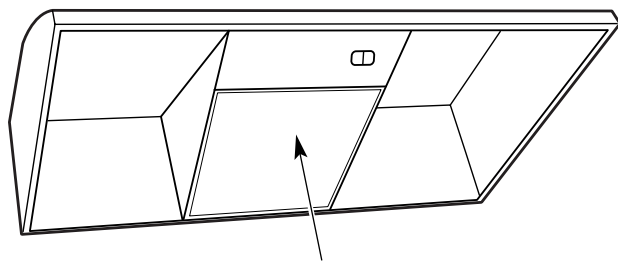

4 REVERSE THE BAFFLE FOR DUCTED INSTALLATIONS ONLY (JV347 and JV367 models)

If the hood is to be recirculated, skip to the next step. Remove the baffle from the top of the hood. Re-install the baffle so the short side marked "VENTED" is visible. The long side of the baffle should be inside the hood.

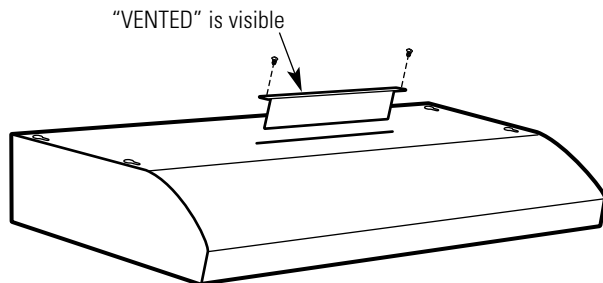

5 REMOVE WIRING COVER

Remove the **wiring cover** from inside the hood. Set the cover and its mounting screw aside.

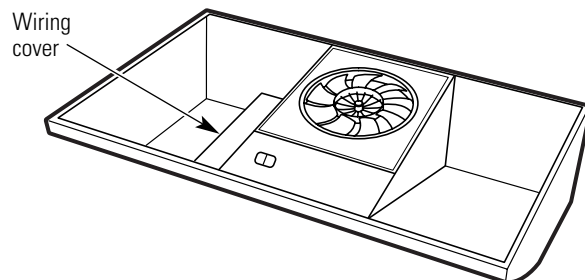

6 REMOVE WIRING KNOCKOUT

Remove either the top or the back wiring knockout as needed and install an approved **strain relief clamp**.

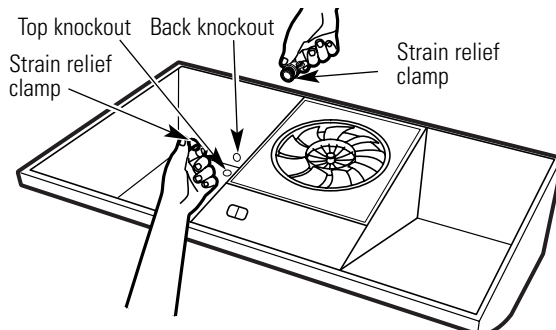

7 REMOVE DUCT KNOCKOUT

If **recirculating**, non-vented ductless (JN327 and RN328, and optional for JV347 and JV367 models only), **skip to Step 10 D and proceed**.

Using a flat blade screwdriver, remove the appropriate **duct knockout** from the top or back of the hood.

3/4" x 10" Rectangular vertical discharge. Remove top rectangular duct knockout only.

7" Round vertical discharge. Remove circular duct knockout only.

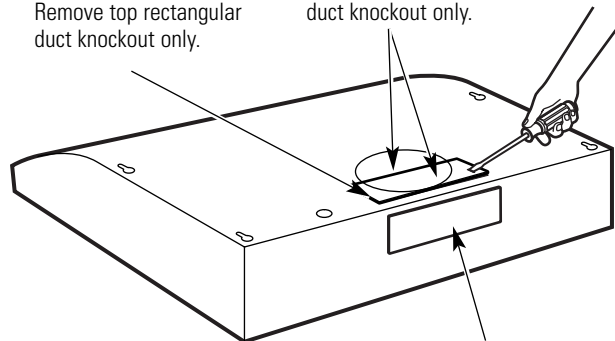

Installation Instructions

8 FOR 3 1/4" X 10" RECTANGULAR DUCTED DISCHARGE INSTALLATIONS ONLY:

Attach **exhaust adaptor/damper** over the appropriate knockout opening (for vertical or horizontal, depending on installation) with two exhaust adaptor screws. Make sure damper **pivot** is nearest to **top/back edge** of hood. Remove **tape** from damper flap.

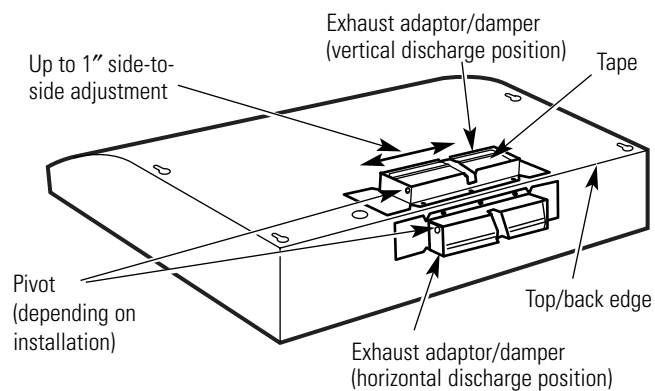

NOTE: The exhaust adaptor/damper can be installed up to 1 inch on either side of the hood center to accommodate off-center ductwork. In extreme off-center installations, one end of the duct connector may need to be trimmed to clear the electrical cable clamp.

10 FOR RECESSED-BOTTOM CABINETS ONLY

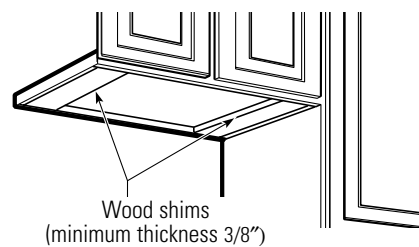

- If the cabinets have front, side or back trim, make 2 wood shims a minimum of 3/8" thick and cut to fit the width of the inner recessed cabinet bottom. Attach them to the cabinet bottom recess on both sides. See Step 11 for marking locations.

9 FOR 7" ROUND VERTICAL DUCTED DISCHARGE INSTALLATIONS ONLY:

Bend up the duct alignment ears in preparation for later attachment of the 7" duct.

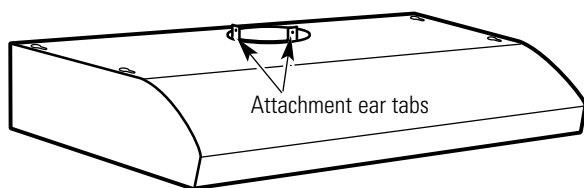

Installation Instructions

11 MARK HOLES

Select the vent option that your installation will require and proceed to that section:

A. Outside top exhaust (Vertical duct—3¼" x 10" Rectangular)

- Use the diagram or the hood as a template and mark the locations on the cabinet for ductwork, electrical wiring and keyhole screw slots.

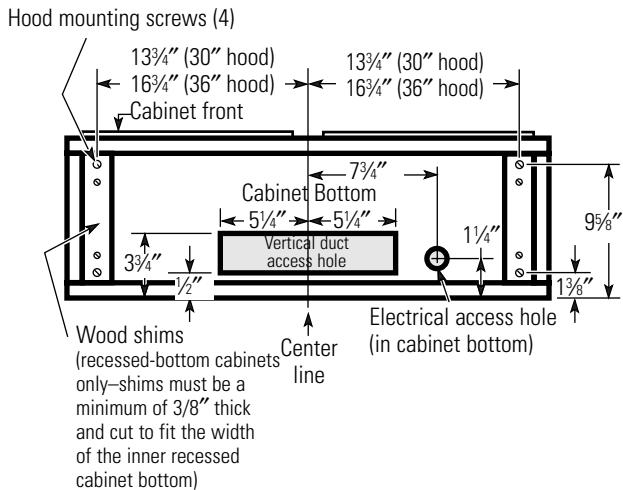

B. Outside top exhaust (Vertical duct—7" Round)

- Use the diagram or the hood as a template and mark the locations on the cabinet for ductwork, electrical wiring and keyhole screw slots.

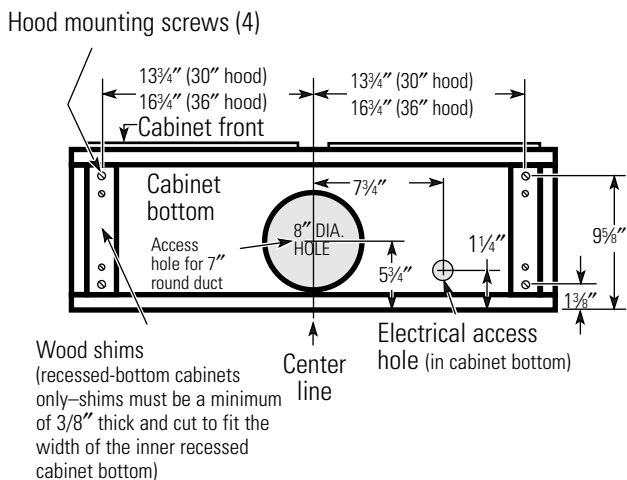

C. Outside rear exhaust (Horizontal duct—3¼" x 10" Rectangular)

- Use the diagram or the hood as a template and mark the locations on the cabinet for ductwork, electrical wiring and keyhole screw slots.

Wood shims (recessed-bottom cabinets only—shims must be a minimum of 3/8" thick and cut to fit the width of the inner recessed cabinet bottom)

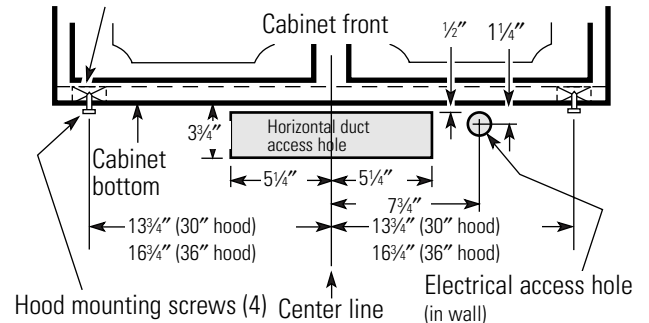

D. Recirculating (non-vented ductless—JN327 and RN328, and optional on JV347 and JV367 models only)

- Use the hood as a template and mark the locations on the cabinet for the electrical wiring and keyhole screw slots.
- Since the hood is to be recirculated (not to be vented outside), do not cut out any vent openings in the wall or cabinet bottom.

12 CUT HOLES

Cut holes at marked locations for duct and electrical wiring. For the vertical duct, cut out 3/4" extra toward the front of the cabinet so you can move the duct freely when installing the hood. It may also ease installation by cutting the hole 10½" instead of 10".

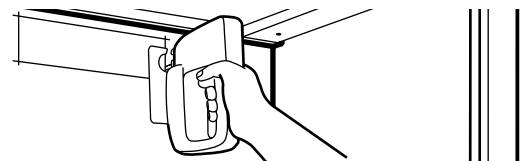

13 RUN WIRES

Run the electrical wires through the wall or cabinet according to National Electrical Code and applicable local codes.

NOTE: DO NOT turn the power on until installation is complete.

Installation Instructions

14 SCREW IN PARTWAY

Drive a mounting screw (from the hardware packet) partway into each center of the narrow neck of the keyhole slots marked on the cabinet bottom.

15 OPTIONAL POWER CORD KIT JXHC1

An optional Power Cord Connection Kit, model JXHC1, is available at extra cost from your GE supplier for installation using a standard 3-prong, grounded wall outlet. Follow the Installation Instructions packed with the kit to connect the power cord to the range hood.

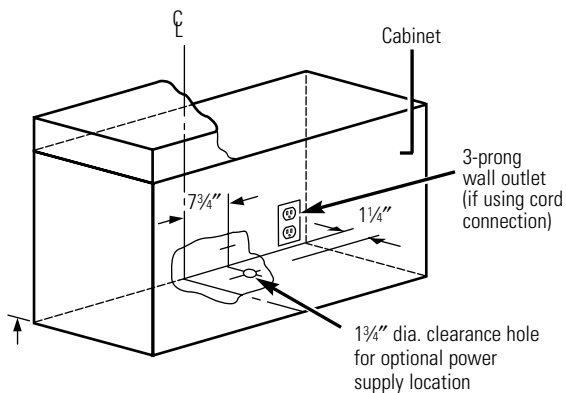

NOTE: If using optional Power Cord Kit JXHC1, feed the power cord through the hole in the top cabinet while raising the hood. Loop any excess length of cord and tie away with a suitable tape or tie.

16 FEED IN WIRES

Lift the hood into position and feed the house wiring through the wiring knockout.

17 SECURE HOOD

Slide the hood back against the wall. Tighten the mounting screws. Be sure the screw heads are in the narrow neck of the keyhole slot.

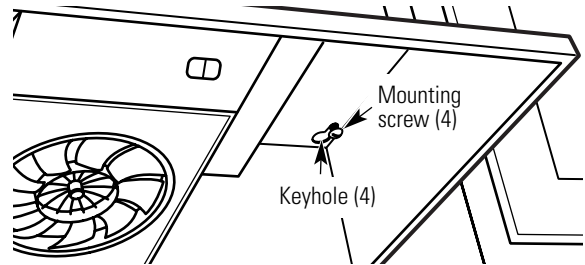

NOTE: DO NOT PUSH ON FAN BLADE. Pushing on the blade may cause it to interfere with other hood parts.

18 CONNECT DUCTWORK TO HOOD (Ducted installations only)

On 7" round installations, attach the 7" duct with sheet metal screws through the holes in the alignment ears.

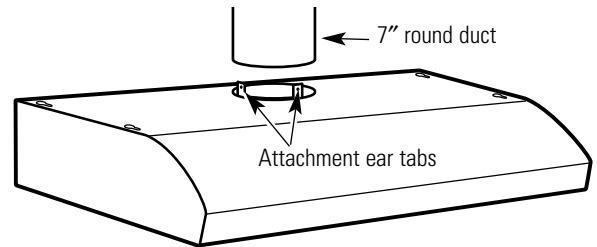

Use duct tape to make joints secure and air tight.

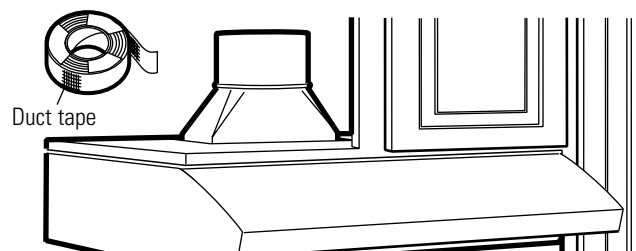

Installation Instructions

19 INSTALL LIGHT BULB

NOTE: A light bulb is not shipped with the hood. Obtain one locally. Purchase and install an ordinary screw-base light bulb, **not more than 60 watts**.

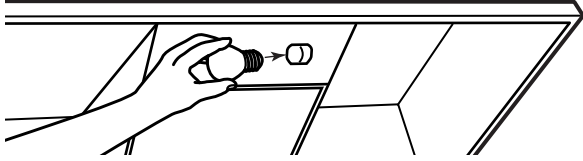

20 FOLLOW ELECTRICAL CODE

Complete the electrical wiring according to National Electrical Code and local codes.

NOTE: This hood must be permanently grounded. Connect **house wiring** (120 VAC) to hood wiring.

21 CONNECT WIRING

Connect house black to hood black wire, house white to hood white wire and house ground under **green ground screw**. Securely tighten the strain relief clamp onto the house wiring.

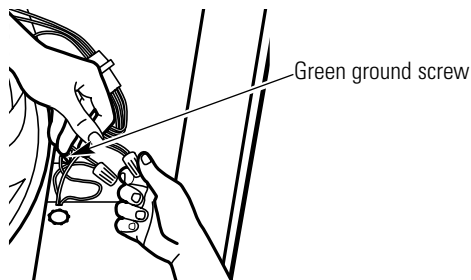

WARNING: IMPROPER CONNECTION OF ALUMINUM HOUSE WIRING TO THESE COPPER LEADS CAN RESULT IN A SERIOUS PROBLEM. USE ONLY CONNECTORS DESIGNED FOR JOINING COPPER TO ALUMINUM AND FOLLOW THE MANUFACTURER'S RECOMMENDED PROCEDURE CLOSELY.

22 REPLACE WIRING COVER

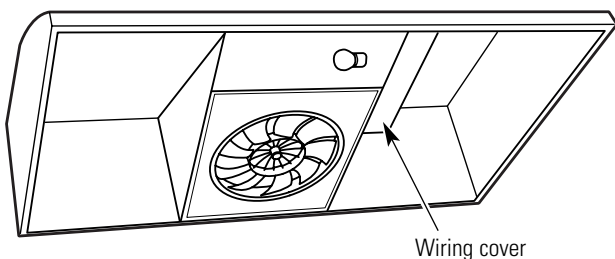

23 REPLACE FILTER

Make sure fan blade turns freely and replace the filter. NOTE: On model JV347, install the metal grease filter if ducted or the charcoal filter if recirculated.

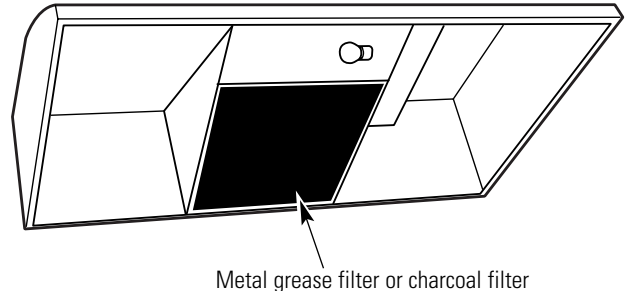

Metal grease filter or charcoal filter

The installation is complete. Turn on power at service panel, and test for proper operation.

TROUBLESHOOTING CHECKLIST

If the hood seems to be operating at high speed when the control is not set on high, or if ventilation seems inadequate, check the following:

- Knockouts not removed from hood.
- Damper blade not opening.
- Reduced airflow because the duct is too small or the duct length is too long.
- The duct is blocked.
- Undersized or restrictive wall or roof cap.

If the hood seems to make excessive noise:

- Fan may be hitting the filter. Turn off the fan and remove the filter. Bend the filter down slightly in the center (into a dome shape) to allow fan clearance. Reinstall and adjust as needed.

The fan does not work but the lights do:

- Switch power off at the service panel and lock the service disconnecting means to prevent power from being switched on accidentally. When the service disconnecting means cannot be locked, securely fasten a prominent warning device, such as a tag, to the service panel.
- Check the wiring connections. See the **CONNECT WIRING** section in these Installation Instructions.

GE Range Hood Warranty.



All warranty service provided by our Factory Service Centers, or an authorized Customer Care® technician. To schedule service, on-line, 24 hours a day, visit us at ge.com, or call 800.GE.CARES (800.432.2737). Please have serial number and model number available when calling for service.

Staple your receipt here.
Proof of the original purchase date is needed to obtain service under the warranty.

For The Period Of: GE Will Replace:

One Year

From the date of the original purchase

Any part of the range hood which fails due to a defect in materials or workmanship. During this **limited one-year warranty**, GE will also provide, **free of charge**, all labor and in-home service to replace the defective part.

What GE Will Not Cover:

- Service trips to your home to teach you how to use the product.
- Improper installation, delivery or maintenance.
- Failure of the product if it is abused, misused, or used for other than the intended purpose or used commercially.
- Replacement of house fuses or resetting of circuit breakers.
- Damage to the product caused by accident, fire, floods or acts of God.
- Incidental or consequential damage caused by possible defects with this appliance.
- Damage caused after delivery.
- Product not accessible to provide required service.

EXCLUSION OF IMPLIED WARRANTIES—Your sole and exclusive remedy is product repair as provided in this Limited Warranty. Any implied warranties, including the implied warranties of merchantability or fitness for a particular purpose, are limited to one year or the shortest period allowed by law.

This warranty is extended to the original purchaser and any succeeding owner for products purchased for home use within the USA. If the product is located in an area where service by a GE Authorized Servicer is not available, you may be responsible for a trip charge or you may be required to bring the product to an Authorized GE Service Location for service. In Alaska, the warranty excludes the cost of shipping or service calls to your home.

Some states do not allow the exclusion or limitation of incidental or consequential damages. This warranty gives you specific legal rights, and you may also have other rights which vary from state to state. To know what your legal rights are, consult your local or state consumer affairs office or your state's Attorney General.

Warrantor: General Electric Company. Louisville, KY 40225

Consumer Support.



GE Appliances Website

ge.com

Have a question or need assistance with your appliance? Try the GE Appliances Website 24 hours a day, any day of the year! For greater convenience and faster service, you can now download Owner's Manuals, order parts or even schedule service on-line.



Schedule Service

ge.com

Expert GE repair service is only one step away from your door. Get on-line and schedule your service at your convenience 24 hours any day of the year! Or call 800.GE.CARES (800.432.2737) during normal business hours.



Real Life Design Studio

ge.com

GE supports the Universal Design concept—products, services and environments that can be used by people of all ages, sizes and capabilities. We recognize the need to design for a wide range of physical and mental abilities and impairments. For details of GE's Universal Design applications, including kitchen design ideas for people with disabilities, check out our Website today. For the hearing impaired, please call 800.TDD.GEAC (800.833.4322).



Extended Warranties

ge.com

Purchase a GE extended warranty and learn about special discounts that are available while your warranty is still in effect. You can purchase it on-line anytime, or call 800.626.2224 during normal business hours. GE Consumer Home Services will still be there after your warranty expires.

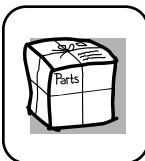

Parts and Accessories

ge.com

Individuals qualified to service their own appliances can have parts or accessories sent directly to their homes (VISA, MasterCard and Discover cards are accepted). Order on-line today, 24 hours every day or by phone at 800.626.2002 during normal business hours.

Instructions contained in this manual cover procedures to be performed by any user. Other servicing generally should be referred to qualified service personnel. Caution must be exercised, since improper servicing may cause unsafe operation.



Contact Us

ge.com

If you are not satisfied with the service you receive from GE, contact us on our Website with all the details including your phone number, or write to: General Manager, Customer Relations
GE Appliances, Appliance Park
Louisville, KY 40225



Register Your Appliance

ge.com

Register your new appliance on-line—at your convenience! Timely product registration will allow for enhanced communication and prompt service under the terms of your warranty, should the need arise. You may also mail in the pre-printed registration card included in the packing material.

Free Manuals Download Website

<http://myh66.com>

<http://usermanuals.us>

<http://www.somanuals.com>

<http://www.4manuals.cc>

<http://www.manual-lib.com>

<http://www.404manual.com>

<http://www.luxmanual.com>

<http://aubethermostatmanual.com>

Golf course search by state

<http://golfingnear.com>

Email search by domain

<http://emailbydomain.com>

Auto manuals search

<http://auto.somanuals.com>

TV manuals search

<http://tv.somanuals.com>