

36 A Li
Art. 4035
42 A Li
Art. 4041

D	Betriebsanleitung Akku-Rasenmäher
GB	Operating Instructions Battery Rechargeable Lawnmower
F	Mode d'emploi Tondeuse sur batterie rechargeable
NL	Instructies voor gebruik Oplaadbare grasmaaier
S	Bruksanvisning Gräsklippare med laddningsbart batteri
DK	Brugsanvisning Batteridrevet genopladelig græsslåmaskine
N	Bruksanvisning Oppladbar gressklipper
FIN	Käyttöohje Akkukäyttöinen ruohonleikkuri
I	Istruzioni per l'uso Tosaerba a batteria ricaricabile
E	Manual de instrucciones Contactésped de batería recargable
P	Instruções de utilização Corta-relva a bateria recarregável
PL	Instrukcja obsługi Kosiarka akumulatorowa
H	Vevő tájékoztató Tölthető akkumulátoros fűnyíró
CZ	Návod k obsluze Akumulátorová sekačka

SK	Návod na používanie Kosačka na nabíjateľnú batériu
GR	Οδηγίες χρήσεως Επαναφορτιζόμενο χλοοκοπτικό μηχανήματος
RUS	Инструкция по эксплуатации Газонокосилка с перезаряжаемым аккумулятором
SLO	Navodila za uporabo Akumulatorska polnilna kosilnica
HR	Uputstva za upotrebu Kosilica na baterije na punjenje
SRB/BIH	Uputstvo za rukovanje Akumulatorska kosilica trave
UA	Інструкція з експлуатації Газонокосарка з акумуляторною батареєю
RO	Instrucțiuni de utilizare Mașină de tuns gazonul pe acumulator
TR	Kullanma Talimatı Şarj edilebilir pilli Çim Biçme makinesi
BG	Инструкция за експлоатация Косачка с презаряждаема батерия
AL	Udhëzimet e përdorimit Makinë për të prerë barin me bateri të rikarikueshme
EST	Kasutusjuhend Laetava akuga muruniiduk
LT	Ekspluatavimo instrukcija Įkraunama akumuliatorinė žoliapjovė
LV	Lietošanas instrukcija Zāles pļāvējs ar uzlādējamu akumulatoru



GARDENA

Battery Rechargeable Lawnmower 36 A Li / 42 A Li

Welcome to the Garden of GARDENA...



This is the original English Instruction Manual.

Please read these operating instructions carefully and observe the information they contain. Use these operating instructions to familiarise yourself with the GARDENA Battery Lawnmower, its proper use and the notes on safety.



For Safety reasons, children under the age of 16 as well as people who are not familiar with the operating instructions, should not use the Battery Lawnmower. Persons with reduced physical or mental abilities may use the product only if they are supervised or instructed by a responsible person.

Contents

→ Please keep these operating instructions in a safe place.	
1. Where to Use Your GARDENA Battery Lawnmower.....	1
2. Safety Instructions	1
3. Assembly	3
4. Function.....	5
5. Initial Operation	5
6. Operation	6
7. Storage	8
8. Maintenance.....	8
9. Troubleshooting	9
10. Technical Data	10
11. Accessories	10
12. Service / Warranty	10

1. Where to Use Your GARDENA Battery Lawnmower

Proper use

The GARDENA Battery Lawnmower is designed for cutting lawn and grass areas of private houses.

Compliance with these instructions provided by GARDENA is a prerequisite for using the battery lawnmower correctly.

Please note



To prevent injury, the GARDENA Battery Lawnmower must not be used for cutting and pruning of climbers or grass on roofs

2. Safety Instructions

→ Please read the notes on safety on the product.



Warning



Read the user instructions carefully to make sure you understand all the controls and what they do.



Always keep the product on the ground when operating. Tilting or lifting the product may cause stones to be thrown out.



Keep bystanders away. Do not operate whilst people especially children or pets are in the area.



Beware of sharp blades - blades continue to rotate after the machine is switched off.



Remove plug from mains before maintenance or if cable is damaged - or in the case of a battery product, remove safety key before maintenance.



Keep the cable supply away from the cutting means. This warning does not apply to battery products.



Checks before each operation:

Before use, an inspection is always to be performed in order to determine that all nuts, bolts and working tools are not worn down or damaged. Worn down or damaged blades are to be replaced in sets.

Do not use the battery lawnmower if safety devices (switch handle, safety key, start button, cover for cutting mechanism) and/or the cutting blade is damaged or worn. Never operate the unit with the safety devices bypassed or missing.

Inspect the surface on which the lawnmower is to be used beforehand. Stones, pieces of wood and wires, as well as other solid matter, must be removed.

Objects, which are contacted by the blade, could be thrown out uncontrollably or damage the cutting mechanism.

Proper use / Responsibility:

Warning ! Take note that the rotating blade could cause injuries

→ **Never place your hands or feet on or under moving parts.**

→ **Do not touch the blades before the disabling device has been removed and the blades have come to a complete stop.**

Do not use the lawnmower while people, especially children or animals, are directly nearby. The operator is liable for damages.

When mowing embankments and slopes, special care is to be taken:

→ make sure you always have a safety distance and wear shoes with a non-slip sole and long trousers. Always cut diagonally to the slope.

→ Do not mow on excessively steep slopes.

Take special care when moving backwards and when pulling the lawnmower. Danger of stumbling!

If, despite taking precautions, you strike an object when working or the lawnmower starts to vibrate vigorously, release the switch handle. Remove the key and the battery from the socket. Remove the blockage, check the lawnmower for any damage and have it repaired if necessary.

→ Only work when visibility is good.

Never leave the battery lawnmower unattended. If you interrupt your work, remove the key and store the lawnmower in a safe place.

Guide the lawnmower at a walking pace only.

Electric Security:

This Battery Lawnmower can cause serious injuries!

→ **To prevent injuries, never start the motor when the mower is tipped.**

Never remove the battery while the motor is running.

Only insert the key into the socket when you plan to start working with the lawnmower.

Familiarise yourself with the surroundings of your working area. Check for possible risks which might not be audible due to the noise of the machine.

Please observe the prescribed local quiet times.

When you interrupt work to move to another working area, always switch off your battery lawnmower and remove the key from the socket.

Do not operate your lawnmower near swimming pools or garden ponds.

Never use the unit when it is raining or in damp or wet areas.

Battery Security:

Danger! Short-circuit - fire risk!

→ **Contacts should never be bridged with metal!**

Danger of fire!

Never charge the battery anywhere near acids and easily inflammable materials.

Danger of explosion!

Do not throw the used battery into fire under any circumstances.

Only charge the battery with the charger supplied! Using other charging units could lead to damage and injury.

Protect the battery from excessive sunlight.

Using a charger other than the GARDENA charger supplied releases GARDENA from all liability and warranty claims.

Keep the charger in a dry place.

Only charge the battery in a dry place.

Only use the battery for the Battery Rechargeable Lawnmower.

The lawnmower cannot be started as long as the charger is plugged in!

Protect the charging socket, battery, safety key and charger against dirt and moisture.

The battery lawnmower may not be powered by any battery other than the one supplied for it.

Under no circumstances use a battery that is not rechargeable.

If the battery develops a leak, remove the safety key, put on gloves, remove the battery and dispose of it.

Do not touch battery acid. If acid comes in contact with the eyes, wash out immediately with water and send for a doctor.

3. Assembly

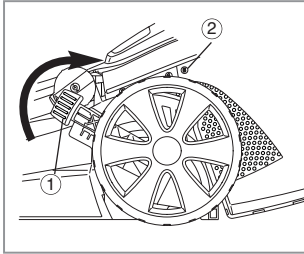

IMPORTANT INFORMATION

⚠ When received from the Manufacturer, the wheels are in a raised position. **Do not switch on the product before removing from the raised ① position into position 5 ②.**

Assembling the lower handle to the lawnmower

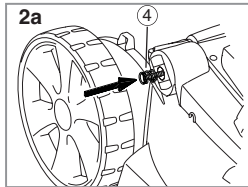
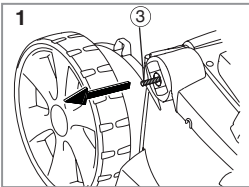

1. Pull the lower handle bolt ③ until it locks into position.
2. Place the Spring ④ and the Pivot Block ⑤ over the Bolt

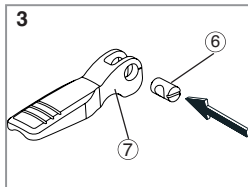
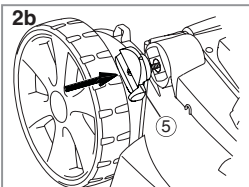

Repeat for the other side.

3. Insert the Barrel Nut ⑥ into the Cam Lock ⑦.

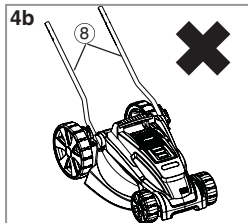
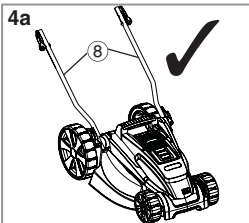

4. Ensuring the Lower Handle is in the correct position ⑧, insert the Lower Handle on to the Bolt until it is firmly fitted into the Pivot Block.

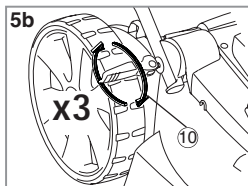
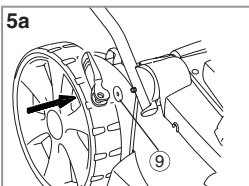

5. Place the Washer ⑨ and Cam Lock on to the Bolt and turn the Cam Lock 3 times clockwise ⑩.

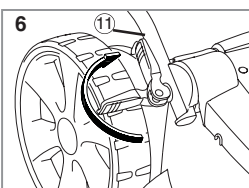

6. Fold down the Cam Lock towards the handle ⑪. If the Cam Lock isn't tightened: open the Cam Lock, turn the Cam Lock one more time and fold down the Cam Lock until the handle ⑪ is secure.

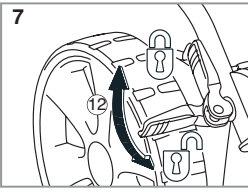

Assembling the upper handle to the lower handles

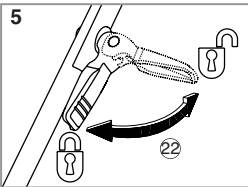
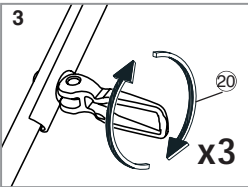
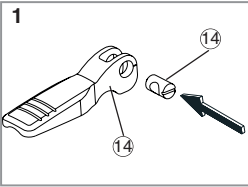

Assembling the grassbox

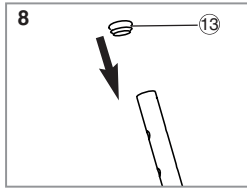
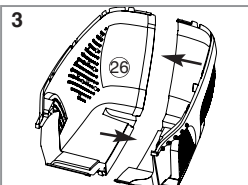
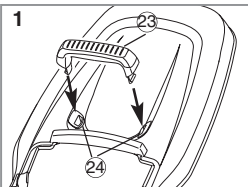

7. The Cam Lock can be unlocked and locked 12.

Repeat for the other side.

8. Insert the two Lower handle plugs 13 into the top of each of the Lower handles.

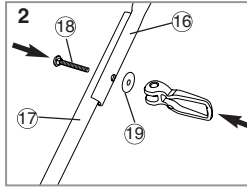

1. Insert the Barrel Nut 14 into the Cam Lock 15 .

2. Attach the Upper Handle 16 to the Lower Handle 17 with the Round Headed Bolt 18, Washer 19 and Cam Lock.

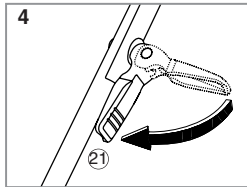

3. Turn the Cam Lock 3 times clockwise 20.

4. Fold down the Cam Lock towards the Handle 21. If the Cam Lock isn't tightened: open the Cam Lock, turn the Cam Lock one more time and fold down the Cam Lock until the handle is secure.

5. The Cam Lock can be unlocked and locked 22.

Repeat for the other side.

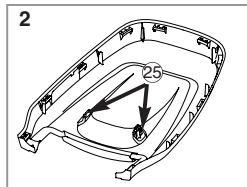

1. Locate the grassbox handle 23 into the slots in the grassbox upper 24 and push until it clicks into position.

2. Looking at the underside of the lid ensure the clips 25 of the grassbox handle are securely located.

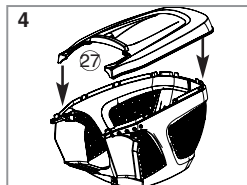

3. Locate the the grassbox halves together 26 by aligning the clips. Ensure all clips are correctly located before clicking into position.

4. Locate the grassbox lid onto the assemble grassbox 27 by aligning the clips. Ensure all clips are correctly located before clicking into position.

Fitting fully assembled grassbox to lawnmower

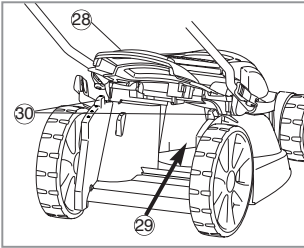

1. Lift safety flap 29.
2. Make sure the discharge chute is clean and free from debris 29.
3. Locate fully assembled grassbox onto 2 location points 30 at the rear of the deck.
4. Locate safety flap onto the top of the grassbox. Ensure the grassbox is securely located.

IMPORTANT !

AFTER FITTING ENSURE NO GAP REMAINS BETWEEN THE SAFETY FLAP AND THE GRASSBOX.

- Removal is the reverse procedure.

For larger areas of grass where grass collection is not required you can use your lawnmower without the grassbox. Ensure the Safety Flap is fully closed. The design of the safety flap permits the cut grass to be discharged downward behind the machine.

4. Function

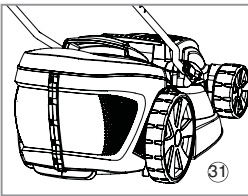

Your product can be used to cut grass using the following methods:-

Grassbox Fitted 31 :- grass is collected effectively and compacted into the grassbox.

Mulch Plug Fitted 32 :- grass cuttings are finely chopped to return nutrients to your lawn.

Rear Discharge 33 :- Effectively cuts long grass with no need to empty the grassbox.

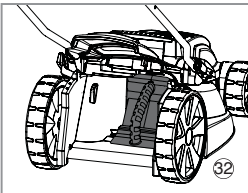

The mowing time depends on the height and moisture of the grass and the charge of the battery.

- Mow twice a week during the growing season, your lawn will suffer if more than a third of its length is cut at one time.

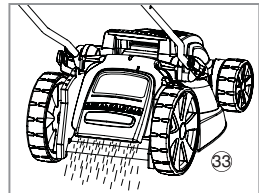

Do Not Overload Your Mower

Mowing long thick grass may cause the motor speed to drop, you will hear a change in the motor sound. If the motor speed drops you may overload your lawnmower which may cause damage. When mowing in long thick grass a first cut with the cutting height set higher will help reduce the load. See Cutting Height Adjustment.

5. Initial Operation

Charging the battery

Before using for the first time, the battery must be fully charged. The lithium-ion battery can be charged in any state of charge, and the charging process can be interrupted at any time without harming the battery (no memory effect).



WARNING !

Overvoltage damages batteries and the battery charger.

→ Ensure the correct mains voltage.

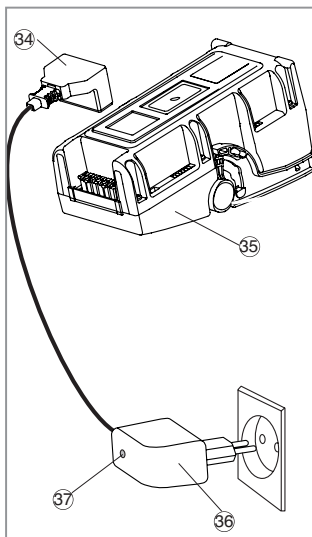

1. Insert the plug of the battery charger 36 into a mains socket.
2. Insert the plug of the charger cable 34 into the battery 35.

The charging indicator lamp 37 on the battery charger lights up red. The battery is being charged.

When the charging indicator lamp lights up green, the battery is fully charged.

Charging times

4035 (battery 8836 / 3,0 Ah) :

4,5 hrs (90% charge) : 9 hrs (100% charge)

4041 (battery 8837 / 4,5 Ah) :

7,5 hrs (90% charge) : 15 hrs (100% charge)

3. First remove the charging cable from the charging socket and then unplug the battery charger from the mains socket.

Attaching the battery to the product



Important !

Ensure that there is no dirt or moisture in the battery socket and battery contacts.

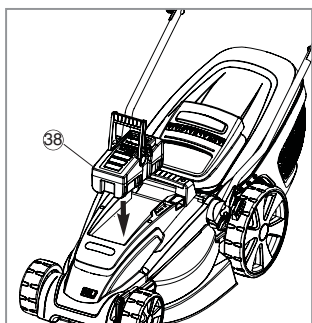

1. Place the battery into the top of the product 38.
2. Fold down the battery handle 39 to lock it into the product

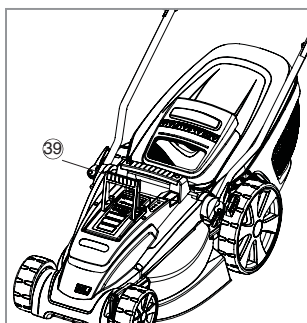

6. Operation

Cutting height adjustment

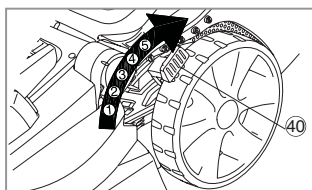

- Height of cut is adjusted by raising or lowering the wheels using the height adjustment lever 40 .
- There are five heights of cut on this product (27 - 65 mm).
 - (1) = 27 mm
 - (2) = 35 mm
 - (3) = 45 mm
 - (4) = 55 mm
 - (5) = 65 mm

A medium height of cut is recommended for most lawns. The quality of your lawn will suffer and collection will be poor if you cut too low.

Starting the lawnmower

Important !
Ensure that there is no dirt or moisture in the battery socket and battery contacts.

The switchbox is provided with a lock-off button 42 to prevent accidental starting.

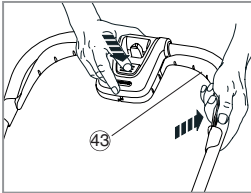
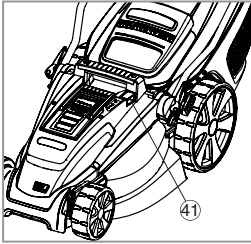

1. Plug in the safety key 41 .

2. Press and hold the lock-off button on the switchbox, then squeeze one of the Start/Stop levers towards the upper handle 43.

Please note:- When starting your lawnmower there will be a slight delay after squeezing the lever and the lawnmower will build up to full speed.

3. Continue to squeeze the start/stop lever towards the upper handle and release the lock-off button.

There are two start/stop levers fitted. Either one can be used for starting the lawnmower.

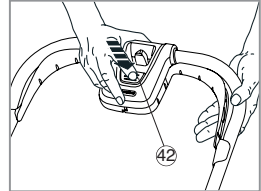

Stopping the lawnmower

1. Release the pressure on the Start/Stop lever.

Battery Level Indication

When switching on the lawnmower, the battery level indicator 44 will show a sequence of lights to enable re-charging

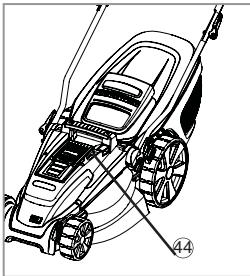

1. Green LED 45 light on:- Full battery capacity (this light will switch off after 20 seconds)
2. Yellow LED 46 light on:- Half battery capacity (this light will switch off after 20 seconds)
3. Red LED 47 light on:- Battery almost dis-charged (this light will switch off after 20 seconds)
4. Red LED 47 light flashing:- Battery discharged, switching on is not possible.

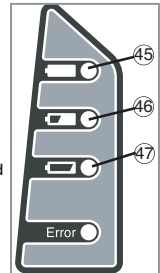

Grassbox full window

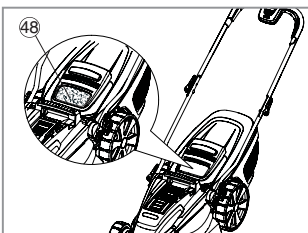

As the grassbox fills up, grass will be visible through the window 48. When the window/grassbox is full it is time to empty the grassbox.

1. Unplug the safety key.
2. Empty the grassbox

Mulching Plug

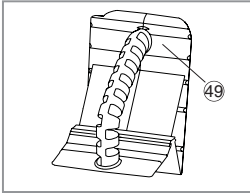

Your lawnmower is supplied with a mulching plug **49**.
The mulching plug prevents grass from being collected by blocking the collection chute on the underside of the deck.

1. Stop your lawnmower as described in **Stopping the lawnmower**.
2. Lift safety flap and insert the mulching plug into rear discharge chute **50**, ensuring it is securely fitted.

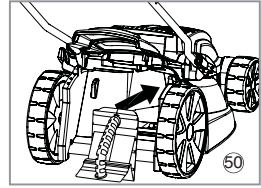

7. Storage

Storage:

The product must be stored out of reach of children.

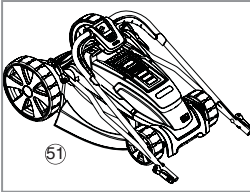

1. Remove the battery and safety key (see 5. Initial Operation)
2. Clean the product (see 9. Maintenance)
3. Charge the battery and store it separately (see 5. Initial Operation)
4. Loosen the Cam Locks to enable the handles to be folded over the product **51**.
5. Store the product in a dry place protected from frost. Do not store outdoors. Keep out of direct sunlight.

Disposal:
(in accordance with
RL2002/96/EC)



**Disposal of
batteries:**



The product must not be added to normal household waste. It must be disposed of in line with local environmental regulations.

→ Important: Make sure that the unit is disposed of via your municipal recycling collection centre.

The GARDENA Battery Mower contains lithium-ion batteries that should not be discarded with normal household waste at the end of their life.

Important:

Please return the lithium-ion batteries to your GARDENA dealer or dispose of them properly at a public recycling centre.

1. Discharge lithium-ion cells completely.
2. Dispose of lithium-ion cells properly.

8. Maintenance

Cleaning

USE GLOVES

IMPORTANT:- It is very important that you keep your lawnmower clean. Grass clippings left in any of the air intakes or under the deck could become a potential fire hazard.

⚠ Important:

Unplug the safety key and remove battery.

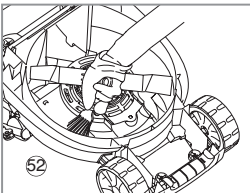

1. Remove grass from under the deck with brush **52**

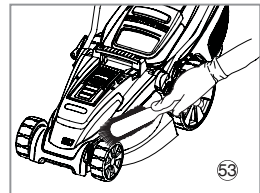

2. Using a soft brush - remove grass clippings from all air intakes **53**, the discharge chute **54** and the grass box **55**.

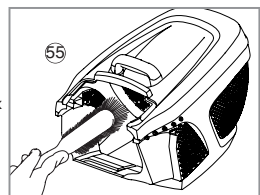
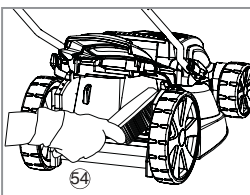

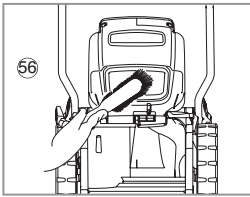

3. Using a soft brush, remove grass clippings from the vision window ⁵⁶.
4. Wipe over the surface of your lawnmower with a dry cloth.

IMPORTANT:- Never use water for cleaning your lawnmower. Do not clean with chemicals, including petrol, or solvents - some can destroy critical plastic parts.

9. Troubleshooting



Important :
Unplug the safety key and remove battery.

IMPORTANT:- Beware of sharp blade ! Wear Gloves

Problem	Possible cause	Remedy
Motor will not start / motor stops while working	Safety key is not inserted	Insert safety key (see 5. Initial Operation)
	Battery is not inserted	Insert Battery (see 5. Initial Operation).
	Red LED light flashing Battery is not charged	Charge Battery (see 5. Initial Operation).
	Green LED and Error LED both lights flashing Motor temperature is high	Put product out of the sun, Wait 15 minutes for product to cool down and re-start.
	Yellow LED and Error LED both lights flashing. Battery temperature is high	Put product out of the sun, Wait 15 minutes for product to cool down and re-start.
	Red LED and Error LED both lights flashing Controller temperature is high	Put product out of the sun, Wait 15 minutes for product to cool down and re-start.
	Error LED light flashing Overcurrent/motor is blocked	Clear obstruction and re-start.
	Error LED light on continuously Controller failure	Product to be checked by GARDENA Service.
	Abnormal noise Excessive Vibration	Screws/components loose
Blade fitted incorrectly		Product to be checked by GARDENA service.
Foreign bodies on the blade		Remove foreign bodies.
Blade very dirty		Clean blade.
Blade damaged		Product to be checked by GARDENA Service.
Poor grass collection	Cutting height too low	Raise cutting height (see 6. Operation - Cutting height adjustment).
	Grassbox is full	Empty grassbox (see 6. Operation - Grassbox full window).
	Grass discharge chute is blocked/ grass has collected under deck	Remove grass (see 8. Maintenance - Cleaning).
Lawn cuts unevenly	Blade is blunt	Product to be checked by GARDENA Service.
	Grass is too long	Raise cutting height (see 6. Operation - Cutting height adjustment)
Lawnmower becomes heavy to push	Grass is too long	Raise cutting height (see 6. Operation - Cutting height adjustment)

10. Technical Data

Battery Rechargeable Lawnmower	36 A Li (Art. 4035)	42 A Li (Art. 4041)
Cutting width / Cutting height	36 cm	42 cm
Cutting height adjustment	27 mm - 65 mm	27 mm - 65 mm
Weight with battery	17.51 kg	18.72 kg
Battery Voltage / capacity	36V, 3.0Ah	36V, 4.5Ah
Lawn area per Battery charge	max. 300 m ²	max. 500 m ²
Working area related emission characteristic value $L_{pa}^{1)}$	77.9 dB (A)	77.9 dB (A)
Noise level $L_{WA}^{2)}$	measured 95 dB (A) guaranteed 96 dB (A)	measured 95 dB (A) guaranteed 96 dB (A)
Hand/arm vibration $a_{vhw}^{1)}$	< 2.5 m/s ²	< 2.5 m/s ²

Measuring method according to 1) EN 786 2) directive 2000/14/EC

11. Accessories

GARDENA Replacement Battery Li-ion 36V	Battery for additional duration or for replacement suitable for both lawnmowers	Art. 8836 - 3,0 Ah Art. 8837 - 4,5 Ah
GARDENA Quick Battery Charger	Charging the batteries up to three times faster.	Art. 8831
GARDENA Blade	As replacement for blunt blade	Art. 4083 - 36cm Art. 4084 - 42cm

12. Service / Warranty

GARDENA guarantees this product for 2 years (from date of purchase). This guarantee covers all serious defects of the unit that can be proved to be material or manufacturing faults. Under warranty we will either replace the unit or repair it free of charge if the following conditions apply:

- The unit must have been handled properly and in keeping with the requirements of the operating instructions.
- Neither the purchaser or a non-authorized third party have attempted to repair the unit.

The blade is a consumable and are not covered by the guarantee.

This manufacturer's guarantee does not affect the user's existing warranty claims against the dealer/seller.

If a fault occurs with your Battery Lawnmower, please return the faulty unit together with a copy of the receipt and a description of the fault, with postage paid to one of the GARDENA Service Centres listed on the back of these operating instructions.

<p>D Produkthaftung</p> <p>Wir betonen ausdrücklich, dass wir nach dem Produkthaftungsgesetz nicht für eventuelle Schäden haften, die durch unsere Geräte verursacht wurden, wenn diese nicht wie vorgeschrieben repariert wurden oder falls Teile durch nicht originale GARDENA-Teile bzw. nicht von uns genehmigte Teile ersetzt wurden, und falls die Reparaturen nicht von einem GARDENA-Kundendienstzentrum oder Vertragshändler ausgeführt wurden. Das Gleiche gilt für Ersatzteile und Zubehör.</p>
<p>GB Product Liability</p> <p>We expressly point out that, in accordance with the product liability law, we are not liable for any damage caused by our units if it is due to im-proper repair or if parts exchanged are not original GARDENA parts or parts approved by us, and, if the repairs were not carried out by a GARDENA Service Centre or an authorised specialist. The same applies to spare parts and accessories.</p>
<p>F Responsabilité</p> <p>Nous vous signalons expressément que GARDENA n'est pas responsable des dommages causés par ses appareils, dans la mesure où ces dommages seraient causés suite à une réparation non conforme, dans la mesure où, lors d'un échange de pièces, les pièces d'origine GARDENA n'auraient pas été utilisées, ou si la réparation n'a pas été effectuée par le Service après-vente GARDENA ou un spécialiste agréé. Ceci est également valable pour les pièces détachées et les accessoires.</p>
<p>NL Productaansprakelijkheid</p> <p>Wij wijzen er uitdrukkelijk op dat, in overeenstemming met de wet inzake productaansprakelijkheid, wij niet aansprakelijk gesteld kunnen worden voor schade veroorzaakt door onze eenheden, wanneer deze is toe te schrijven aan incorrecte reparaties of als onderdelen vervangen zijn door onderdelen anders dan die van GARDENA of door onderdelen die niet door ons zijn goedgekeurd, en wanneer de reparatie niet is uitgevoerd door een onderhoudscentrum van GARDENA of een bevoegde specialist. Hetzelfde geldt voor reserveonderdelen en accessoires.</p>
<p>S Produktansvar</p> <p>Vi uttrykkigen påpeker att i enlighet med produktansvarslagen ansvarar vi inte för skador orsakade av våra enheter om de är på grund av felaktig reparation eller om delar utbytta inte är original från GARDENA eller delar godkända av oss, och om reparationerna inte utfördes av ett GARDENA servicecenter eller en auktoriserad specialist. Detsamma gäller för reservdelar och tillbehör.</p>
<p>DK Produktansvar</p> <p>Vi gør udtrykkelig opmærksom på, at ifølge produktansvarsloven er vi ikke ansvarlig for nogen skade forårsaget af vores enheder, hvis det skyldes uhensigtsmæssig reparation, eller hvis udskiftede dele ikke er originale GARDENA-dele eller dele, der er godkendt af os, og hvis reparationen ikke blev udført af et GARDENA Service Centre eller en autoriseret specialist. Det samme gælder for reservedele og tilbehør.</p>
<p>N Produktansvar</p> <p>Vi påpeker uttrykkelig at ifølge produktansvarsloven, er vi ikke ansvarlig for noe skade forårsaket av våre enheter hvis det skyldes uhensigtsmessig reparasjon, eller hvis utskiftede deler ikke er originale GARDENA-deler, eller deler som ikke er godkjent av oss, og, hvis reparasjonen ikke ble foretatt av et GARDENA Servicesenter eller en autorisert spesialist. Det samme gjelder for reservedeler og tilbehør.</p>
<p>FIN Tuotevastuu</p> <p>Huomautamme nimenomaan, että tuotevastuulain mukaan emme ole vastuussa mistään yksikkömmä aiheuttamasta vahingosta, jos se johtuu epäasiallisesta korjauksesta tai jos vaihdetut osat eivät ole alkuperäisiä GARDENA:n osia tai hyväksymämme osia, tai korjaukset on suoritettu muu kuin GARDENA:n huoltopiste tai valtuutettu ammattihenkilö. Tämä sama koskee myös varaosia ja lisävarusteita.</p>
<p>I Responsabilità del prodotto</p> <p>Si rende espressamente noto che, conformemente alla legge sulla responsabilità del prodotto, non si risponde di danni causati dalle nostre macchine se originati da riparazioni eseguite non correttamente o da sostituzioni di parti effettuate con materiale non originale GARDENA o comunque da noi non approvato e, in ogni caso, qualora l'intervento non venga eseguito da un centro servizi GARDENA o da personale specializzato autorizzato. Lo stesso vale per parti di ricambio e accessori.</p>
<p>E Responsabilidad por producto</p> <p>Señalamos expresamente que, según la ley de responsabilidad por producto, no somos responsables de cualquier daño causado por nuestros aparatos si ello es debido a una reparación incorrecta o si las piezas de repuesto no son genuinas o aprobadas por GARDENA, y si las reparaciones no han sido realizadas por un Centro de Servicio GARDENA o por un especialista autorizado. Lo mismo es aplicable a las piezas de repuesto y accesorios.</p>
<p>P Responsabilidade pelo equipamento</p> <p>Salientamos expressamente que, de acordo com a lei de responsabilidade por equipamentos, não somos responsáveis por quaisquer danos causados pelas nossas unidades caso estes se devam a uma reparação inadequada ou se os componentes substituídos não forem componentes GARDENA originais ou componentes aprovados por nós, e, se as reparações não forem realizadas por um centro de assistência GARDENA ou por um técnico especializado autorizado. O mesmo princípio se aplica a peças sobressalentes e acessórios.</p>
<p>PL Odpowiedzialność za produkt</p> <p>Wyraźnie stwierdzamy, zgodnie z przepisami o odpowiedzialności za produkt, iż nie odpowiadamy za żadne zniszczenia spowodowane przez nasze urządzenia, jeżeli wynikają one z niewłaściwej naprawy lub jeśli użyte części zamienne nie są oryginalnymi częściami GARDENA bądź elementami zatwierdzonymi przez nas oraz jeśli naprawy nie były wykonywane przez Centrum Serwisowe GARDENA lub autoryzowanego specjalistę. To samo dotyczy części zamiennych oraz akcesoriów.</p>

<p>BG Отговорности към продукта</p> <p>Изрично съобщаваме, че в съответствие с разпоредбите по отношение на отговорността не следва да носим отговорност за всяка повреда, причинена от продуктите ни или възникнала вследствие на неправилно извършен ремонт или смяна на части с части, които не са оригинални части на GARDENA и не са одобрени от наша страна, както и ако ремонтните работи не са извършени от сервизен център на GARDENA или упълномощен специалист. Същото важи и за резервните части и принадлежности.</p>	
<p>AL Përgjegjësia ndaj produktit</p> <p>Ne theksojmë shprehimisht se, në përpunje me ligjin për përgjegjësinë ndaj produktit, ne nuk jemi përgjegjës për asnjë dëmtim që shkaktohet nga produktet tona nëse ai kryhet për shkak të riparimit jo të dukur ose nëse pjesët e ndërruara nuk janë origjinale të GARDENA-s ose pjesët të aprovuara nga ne, dhe, nëse riparimet nuk janë kryer nga qendra e shërbimit të GARDENA-s ose nga një specialist i autorizuar. E njëjta procedurë zbatohet edhe për pjesët e këmbimit dhe aksesoret.</p>	
<p>EST Tootevastutus</p> <p>Juhime teie tähelepanu sellele, et kooskõlas tootevastutusseadustega ei ole me vastutavad meie seadmete põhjustatud mis tahes kahjude eest, kui need on tingitud ebakorrektest parandusest või kui seadme vahetatud osad ei ole GARDENA originaalosa või meie heakskiidu saanud osad ning kui parandustöid ei teinud GARDENA teeninduskeskus või volitatud spetsialist. Sama kehtib ka varuosade ja tarvikute kohta.</p>	
<p>LT Atsakomybė už gaminį</p> <p>Mes aiškiai nurodome, kad atsivielgiant į atsakomybės už gaminį įstatymą nesame atsakingi už mūsų įrenginių padarytą žalą juos netinkamai suremontavus ar pakeitus dalis ne originaliomis GARDENA dalimis arba ne mūsų patvirtintomis dalimis, taip pat, jei remonto darbus atliko ne GARDENA techninės priežiūros centras arba įgaliotas specialistas. Tai taip pat taikoma atsarginėms dalims ir priedams.</p>	
<p>LV Produkta drošumattilbība</p> <p>Mēs īpaši uzsveram, ka saskaņā ar likumu "Atbildība par izlaistās produkcijas kvalitāti" neesam atbildīgi par bojājumiem, kas radušies mūsu izstrādājumu dēļ, ja ir veikts nekvalitatīvs izstrādājumu remonts vai to detaļās nomainītas pret neoriģinālām GARDENA detaļām vai detaļām, ko neesam apstiprinājuši, kā arī, ja remontu neveica GARDENA klientu apkalpošanas centrs vai pilnvarots speciālists. Tas pats attiecas uz rezerves daļām un piederumiem.</p>	
<p>D EU-Konformitätserklärung</p> <p>Die unterzeichnende GARDENA Manufacturing GmbH, Hans-Lorenser-Str. 40, D-89079 Ulm, bescheinigt hiermit, dass die unten angegebenen Geräte bei Auslieferung aus unserem Werk die harmonisierten EU-Richtlinien und EU-Normen hinsichtlich der Sicherheit und produktspezifischen Standards erfüllen. Dieses Zertifikat wird ungültig, wenn die Geräte ohne unsere Genehmigung modifiziert werden.</p>	<p>DK EU-overensstemmelsescertifikat</p> <p>Undertegnede GARDENA Manufacturing GmbH, Hans-Lorenser-Str. 40, D-89079 Ulm, Tyskland, bekræfter hermed, at den nedenfor anførte enhed var i overensstemmelse med de harmoniserede EU-retningslinier, EU-sikkerhedsstandarder samt produktspecifikke standarder, da den forlod vores fabrik. Dette certifikat bliver ugyldigt, hvis enheden modificeres uden vores godkendelse.</p>
<p>GB EU Certificate of Conformity</p> <p>The undersigned GARDENA Manufacturing GmbH, Hans-Lorenser-Str. 40, D-89079 Ulm, hereby certifies that, when leaving our factory, the units indicated below are in accordance with the harmonised EU guidelines, EU standards, of safety and product specific standards. This certificate becomes void if the units are modified without our approval.</p>	<p>N EU konformitetsertifikat</p> <p>Undertegnede, GARDENA Manufacturing GmbH, Hans-Lorenser-Str. 40, D-89079 Ulm, herved attesterer at, når sendt fra fabrikken, er enhetene nedenfor i henhold til EU's harmoniserede retningslinjer, EU-standarder, når det gjelder sikkerhet og produktspecifikke standarder. Dette konformitetsertifikatet blir ugyldig hvis enhetene blir modifisert uten vår godkjenning.</p>
<p>F Certificat de conformité UE</p> <p>Le constructeur, soussigné : GARDENA Manufacturing GmbH, Hans-Lorenser-Str. 40, D-89079 Ulm, certifie que le matériel neuf désigné ci-après est conforme aux exigences des normes européennes harmonisées et conforme aux règles de sécurité et autres règles qui lui sont applicables dans le cadre de l'Union européenne. Toute modification apportée à ce produit sans l'accord express de GARDENA annule la validité de ce certificat.</p>	<p>FIN EU:n vaatimustenmukaisuustodistus</p> <p>Alekirjoittanut GARDENA Manufacturing GmbH, Hans-Lorenser-Str. 40, D-89079 Ulm, todistaa täten, että tehtaaltamme lähtevänsään alla osoitetut yksiköt noudattavat harmonisoituja EU:n yleisoheita. EU:n turvallisuusstandardreja ja tuotekohtaisia standardeja. Tämä todistus mitätöityy, jos yksikköjä muunnetaan ilman hyväksymistämme.</p>
<p>NL EU Certificate van Conformiteit</p> <p>De ondergetekende GARDENA Manufacturing GmbH, Hans-Lorenser-Str. 40, D-89079 Ulm, certificeert hierbij dat de hieronder gespecificeerde eenheden bij het verlaten van de fabriek in overeenstemming waren met de geharmoniseerde richtlijnen en de normen van de EU inzake veiligheid en productspecifieke normen. Dit certificaat komt te vervallen wanneer de eenheden zonder onze goedkeuring gewijzigd worden.</p>	<p>I Dichiarazione di conformità UE</p> <p>La sottoscritta GARDENA Manufacturing GmbH, Hans-Lorenser-Str. 40, D-89079 Ulm, con la presente certifica che i prodotti di seguito indicati, nei modelli da noi commercializzati, sono conformi alle direttive armonizzate UE nonché agli standard di sicurezza e quelli relativi ai singoli articoli. Qualsiasi modifica dei prodotti apportata senza la nostra autorizzazione invalida la presente dichiarazione.</p>
<p>S EU Intyg om överensstämmelse</p> <p>Undertecknade GARDENA Manufacturing GmbH, Hans-Lorenser-Str. 40, D-89079 Ulm, härmed intygar att, vid frakt från fabriken, enheterna indikerad nedan är i förenlighet med de harmoniserade EU-riktlinjerna, EU säkerhetsstandard och produktspecifikt standard. Detta intyg gäller inte längre om enheterna modifieras utan vårt godkännande.</p>	<p>E Certificado de Conformidad de la UE</p> <p>El abajo firmante GARDENA Manufacturing GmbH, Hans-Lorenser-Str. 40, D-89079 Ulm, certifica por ésta, que al salir de fábrica, las unidades indicadas más abajo están de acuerdo con las directrices armonizadas de la UE, las normativas de la UE y las normativas específicas de seguridad y del producto. Este certificado se hace nulo si las unidades han sido modificadas sin nuestra aprobación.</p>

Ulm, den 27.01.2010	Bevollmächtigter Vertreter
Ulm, 27.01.2010	Authorised representative
Fait a Ulm. le 27.01.2010	Représentant agréé
Ulm, 27.01.2010	Bevoegd vertegenwoordiger
Ulm, 2010.01.27	Auktoriserad representant
Ulm, 27.01.2010	Autoriseret repræsentant
Ulm, 27.01.2010	Autorisert representant
Ulm, 27.01.2010	Valtuutettu edustaja
Ulm, 27.01.2010	Rappresentante autorizzato
Ulm, 27.01.2010	Representante autorizado
Ulm, 27.01.2010	Representante autorizado
Ulm, 27.01.2010	Autoryzowany przedstawiciel
Ulm, 27.01.2010	Jóváhagyott
Ulm, 27.01.2010	Pověřený zástupce
Ulm, 27.01.2010	Autorizovaný zástupca
Ulm, 27.01.2010	Εξουσιοδοτημένος αντιπρόσωπος
Ulm, 27.01.2010	Авторизованный представитель
Ulm, 27.01.2010	Pooblaščení predstavnik
Ulm, 27.01.2010	Ovlašteni zastupnik
Ulm, 27.01.2010	Ovlašćeni predstavnik
Ulm, 27.01.2010	Уповноважений представник
Ulm, 27.01.2010	Reprezentant autorizat
Ulm, 27.01.2010	Yetkili temsilci
Ulm, 27.01.2010	Упълномощен представител
Ulm, 27.01.2010	Përfaqësuesi i autorizuar
Ulm, 27.01.2010	Volitatud esindaja
Ulm, 2010.27.01	Igaliotas atstovas
Ulma, 27.01.2010	Pilnvarotais pārstāvis



Peter Lameli
Vice President

Deutschland / Germany
GARDENA
Manufacturing GmbH
Central Service
Hans-Lorenser-Straße 40
D-89079 Ulm
Produktfragen:
(+49) 731 490-123
Reparaturen:
(+49) 731 490-290
service@gardena.com

Argentina
Husqvarna Argentina S.A.
Vera 745
(C1414A00) Buenos Aires
Phone: (+54) 11 4858-5000
diego.poggi@ar.husqvarna.com

Australia
Husqvarna Australia Pty. Ltd.
8 Park Drive
Dandenong VIC 3175

Austria / Österreich
GARDENA
Österreich Ges.m.b.H.
Stettnerweg 11-15
2100 Korneuburg
Tel.: (+43) 22 62 7 45 45 36
kundendienst@gardena.at

Belgium
GARDENA Belgium NV/SA
Sterrebeekstraat 163
1930 Zaventem
Phone: (+32) 2 7 20 92 12
Mail: info@gardena.be

Brazil
Palash Comércio e
Importação Ltda.
Rua São João do Araguaia, 338
- Jardim Califórnia -
Barueri - SP - Brasil -
CEP 06409-060
Phone: (+55) 11 4198-9777
eduardo@palash.com.br

Bulgaria
Хускарна България ЕООД
1799 София
Бул. „Андрей Ляпчев“ № 72
Тел.: (+359) 2 80 99 424
www.husqvarna.bg

Canada
GARDENA Canada Ltd.
100 Summerlea Road
Brampton, Ontario L6T 4X3
Phone: (+1) 905 792 93 30
info@gardenacanada.com

Chile
Antonio Martinic y Cia Ltda.
Cassillas 272
Centro de Cassillas
Santiago de Chile
Phone: (+56) 2 20 10 708
garfar_cl@yahoo.com

Costa Rica
Compania Exim
Euroiberamericana S.A.
Los Colegios, Moravia,
200 metros al Sur del Colegio
Saint Francis - San José
Phone: (+506) 297 68 83
exim_euro@racsa.co.cr

Croatia
KLIS d.o.o.
Stanciceva 79
10419 Vukovina
Phone: (+385) 1 622 777 0
gardena@klis-trgovina.hr

Cyprus
FARMOKIPIKI LTD
P.O. Box 7098
74, Digeni Akritia Ave.
1641 Nicosia
Phone: (+357) 22 75 47 62
condam@spidernet.com.cy

Czech Republic
GARDENA spol. s r.o.
Tuřanka 115
627 00 Brno
Phone: (+420) 800 100 425
gardena@gardenabrno.cz

Denmark
GARDENA
Husqvarna Consumer Outdoor
Products
Salgsafdelning Danmark
Box 9003
S-200 39 Malmö
info@gardena.dk

Estonia
Husqvarna Eesti OÜ
Consumer Outdoor Products
Kesk tee 10, Aaviku küla
Rae vald, Harju maakond
75305
kontakt.etj@husqvarna.ee

Finland
Oy Husqvarna Ab
Consumer Outdoor Products
Lautatarhankatu 8 B / PL 3
00581 HELSINKI
info@gardena.fi

France
GARDENA
PARIS NORD 2
69, rue de la Belle Etoile
BP 57080
ROISSY EN FRANCE
95948 ROISSY CDG CEDEX
Tél. (+33) 0826 101 455
service.consommateurs@
gardena.fr

Great Britain
Husqvarna UK Ltd
Preston Road
Aycliffe Industrial Park
Newton Aycliffe
County Durham
DL5 6UP
info.gardena@
husqvarna.co.uk

Greece
Agrokop
Psmadopoulos S.A.
Ifaistou 33A
Industrial Area Koropi
194 00 Athens Greece
V.A.T. EL093474846
Phone: (+30) 210 66 20 225
service@agrokop.gr

Hungary
Husqvarna
Magyarország Kft.
Ezred u. 1-3
1044 Budapest
Phone: (+36) 80 20 40 33
gardena@gardena.hu

Iceland
Ó. Johnson & Kaaber
Tunguhalsi 1
110 Reykjavik
ooj@ojk.is
Ireland
Michael McLoughlin & Sons
Hardware Limited
Long Mile Road
Dublin 12

Italy
GARDENA Italia S.p.A.
Via Donizetti 22
20020 Lainate (Mi)
Phone: (+39) 02.93.94.79.1
info@gardenaitalia.it

Japan
KAKUICHI Co. Ltd.
Sumitomo Realty &
Development Kojimachi
BLDG., 8F
5-1 Nibanncyo, Chiyoda-ku
Tokyo 102-0084
Phone: (+81) 33 264 4721
m_ishihara@kaku-ichi.co.jp
Latvia
SIA „Husqvarna Latvija”
Consumer Outdoor Products
Bākūžu iela 6, Rīga, LV-1024
info@husqvarna.lv

Lithuania
UAB Husqvarna Lietuva
Consumer Outdoor Products
Aiteities pl. 77C
LT-52104 Kaunas
centras@husqvarna.lt

Luxembourg
Magasins Jules Neuberger
39, rue Jacques Stas
Luxembourg-Gasperich 2549
Case Postale No. 12
Luxembourg 2010
Phone: (+352) 40 14 01
api@neuberger.lu

Netherlands
GARDENA Nederland B.V.
Postbus 50176
1305 AD ALMERE
Phone: (+31) 36 521 00 00
info@gardena.nl

Neth. Antilles
Jonka Enterprises N.V.
Sta. Rosa Weg 196
P.O. Box 8200, Curaçao
Phone: (+599) 9 767 66 55
pgm@jonka.com

New Zealand
Husqvarna NZ Ltd.
15 Earl Richardson Ave/
Manukau City
Auckland

Norway
GARDENA
Husqvarna Consumer Outdoor
Products
Salgskontor Norge
Kleverveien 6
1540 Vestby
info@gardena.no

Poland
GARDENA Polska Sp. z o.o.
Szymanów 9 d
05-532 Banioccha
Phone: (+48) 22 727 56 90
gardena@gardena.pl

Portugal
GARDENA Portugal Lda.
Sintra Business Park
Edifício 1, Fração 0-G
2710-089 Sintra
Phone: (+351) 21 922 85 30
info@gardena.pt

Romania
MADEX INTERNATIONAL SRL
Soseaua Odaii 117-123,
Sector 1,
Bucuresti, RO 013603
Phone: (+40) 21 352 76 03
madex@ines.ro

Russia / Россия
ООО ГАРДЕНА РУС
123007, г. Москва
Хорошевское шоссе, д. 32А
Тел.: (+7) 495 380 31 80
info@gardena-rus.ru

Singapore
Hy - Ray PRIVATE LIMITED
40 Jalan Pemimpin
#02-08 Tat Ann Building
Singapore 577185
Phone: (+65) 6253 2277
hyray@singnet.com.sg

Slovak Republic
GARDENA Slovensko, s.r.o.
Panónska cesta 17
851 04 Bratislava
Phone: (+421) 263 453 722
info@gardena.sk

Slovenia
GARDENA d.o.o.
Brodišče 15
1236 Trzin
Phone: (+386) 1 580 93 32
servis@gardena.si

South Africa
GARDENA
South Africa (Pty.) Ltd.
P.O. Box 11534
Vorna Valley 1686
Phone: (+27) 11 315 02 23
sales@gardena.co.za

Spain
GARDENA IBÉRICA S.L.U.
C/ Basauri, nº 6
La Florida
28023 Madrid
Phone: (+34) 91 708 05 00
atencioncliente@gardena.es

Sweden
GARDENA
Husqvarna Consumer Outdoor
Products
Försäljningskontor Sverige
Box 9003
200 39 Malmö
info@gardena.se

Switzerland / Schweiz
Consumer Products
Husqvarna Schweiz AG
Industriestrasse 10
5506 Mägenwil
Phone: (+41) (0) 848 800 464
info@gardena.ch

Turkey
GARDENA / Dost Diş Ticaret
Mümessillik A.Ş. Sanayi
Çad. Adil Sokak No.1
Kartal - Istanbul
Phone: (+90) 216 38 93 939
info@gardena-dost.com.tr

Ukraine / Україна
ТОВ «ГАРДЕНА УКРАЇНА»
Васильківська, 34, 204-Г
03022, Київ
Тел. (+38 044) 498 39 02
info@gardena.ua

USA
Melnor Inc.
3085 Shawnee Drive
Winchester, VA 22604
Phone: (+1) 540 722-9080
service_us@melnor.com
04035-20.960.01/ 0110
© GARDENA
Manufacturing GmbH
D-89070 Ulm
http://www.gardena.com

5739499-01

Free Manuals Download Website

<http://myh66.com>

<http://usermanuals.us>

<http://www.somanuals.com>

<http://www.4manuals.cc>

<http://www.manual-lib.com>

<http://www.404manual.com>

<http://www.luxmanual.com>

<http://aubethermostatmanual.com>

Golf course search by state

<http://golfingnear.com>

Email search by domain

<http://emailbydomain.com>

Auto manuals search

<http://auto.somanuals.com>

TV manuals search

<http://tv.somanuals.com>