

Art. 7834  
Art. 7835

RP 240 / RP 300 / RP 420

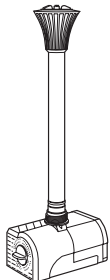

Art. 7838

RP 600

**D** **Gebrauchsanweisung**  
Zimmerbrunnenpumpe

**GB** **Operating Instructions**  
Indoor Fountain Pump

**F** **Mode d'emploi**  
Pompe pour fontaine d'intérieur

**NL** **Gebruiksaanwijzing**  
Binnenshuis-fonteinpomp

**S** **Bruksanvisning**  
Pump för inomhusfontän

**I** **Istruzioni per l'uso**  
Pompa per fontana da interni

**E** **Manual de instrucciones**  
Bomba para fuente de interior

**P** **Instruções de utilização**  
Bomba para fontes interiores

**DK** **Brugsanvisning**  
Springvandspumpe indendørs

# GARDENA Indoor Fountain Pump

## RP 240 / RP 300 / RP 420 / RP 600

---

*Welcome to the garden of GARDENA...*



Please read these operating instructions carefully and observe the notes given. Use these operating instructions to familiarise yourself with the Indoor Fountain Pump, its proper use and the notes on safety.



For safety reasons, children under the age of 16 and people not familiar with these operating instructions must not use this Indoor Indoor Fountain Pump.

→ Please keep these operating instructions in a safe place.

### **Contents:**

1. Where to Use Your GARDENA Indoor Fountain Pump .....	15
2. Safety instructions .....	15
3. Initial Operation .....	17
4. Storage .....	18
5. Cleaning .....	19
6. Troubleshooting .....	21
7. Accessories .....	22
8. Technical data .....	22
9. Service / Warranty .....	23

# 1. Where to Use Your GARDENA Indoor Fountain Pump

## *Correct use:*

GARDENA Indoor Fountain Pumps have been designed for private use around your house. They are not designed for operating watering tools and systems. Pumps RP 240 / RP 300 / RP 600 must only be used indoors. Pump RP 420 is part of Fountain Set Art. 7767 and is suitable for outdoor use.

## *Please note:*



**GARDENA Indoor Fountain Pumps have not been designed for constant use in the industrial sector. Corrosive, easily combustible, aggressive or explosive substances (e.g. petrol, petroleum, nitro thinner) as well as saltwater or food / drinking water must not be pumped.**

## 2. Safety instructions

### *Electrical safety:*



**DANGER! Electric shock!**

→ **Always disconnect the fountain pump from the mains before undertaking any work.**

The pump should be operated via a residual current device with a residual current rating of  $\leq 30$  mA (DIN VDE 0100-702 and 0100-738). The pump must be placed on solid, even ground.

→ Please consult a qualified electrician for advice.

Mains power cables must not have a smaller cross-section than a PVC cable of the designation H03 VV (RP 420 of the designation H05 RNF). Extension cables must meet the requirements of DIN VDE 0620.

Data indicated on the type plate must match technical data of the mains supply.

Please unplug the fountain pump after operation and before carrying out any maintenance works.

The fountain pump must not be operated when there are people in the water.

Swimming pools and garden ponds should be designed according to international and national design regulations.

→ Please consult a qualified electrician for advice.

Before operating the fountain pump, look to see if there is any damage to the fountain pump (esp. regarding power cable and plug).

The connection cable of the pump cannot be

replaced. If the cable is damaged the pump must be disposed of.

Do not use the power cable to carry the pump or to pull the plug out of the socket.

Protect the power cable from heat, oil and sharp edges.

***For Austria:***

Pumps for use in swimming pools and ponds may only be operated via an isolating transformer.

→ Please consult a professional electrician.

***For Switzerland:***

In Switzerland mobile appliances which are used outdoors must be connected via a residual-current device.

***User instructions:***

**Never let the pump run dry; running dry generates heat and will damage the pump.**

The temperature of the liquid used must not be below 4 °C or above 35 °C.

Sand and other abrasive substances in the liquid cause increased wear and reduce the output of the pump.

Please observe the local noise prevention regulations.

### 3. Initial Operation

#### Starting up the pump:

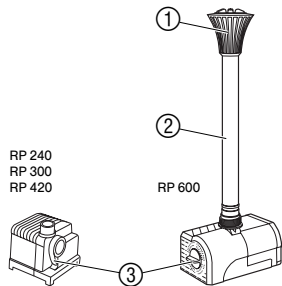

1. RP 600: Insert the fountain socket ① and nozzle tube ②.
2. Install the pump at ground level so that the filter housing is standing in water to at least half its height (with pumps RP 240 / RP 300 / RP 420 make sure that the sides of the foam filter under the pump are not blocked).
3. Plug mains plug into an AC power socket.  
**Warning: Pump will start immediately.**
4. Use the flow control ③ to set the desired water flow for the fountain pump.

**Commissioning the pump if  
it is installed out of water:**

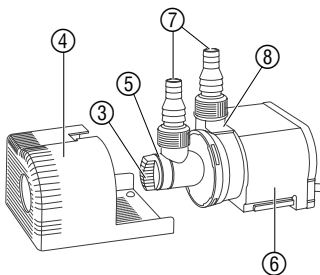

If the pump is installed out of water, the filter housing ④ must be taken off.

1. Pull off the filter housing ④.
2. Turn the pump inlet ⑤ anticlockwise and pull it vertically off the motor housing ⑥ (bayonet socket).
3. Depending on the pumping application, the pump inlet can be rotated in 90° steps. Twist the pump inlet ⑤ accordingly, again press it vertically on to motor housing ⑥ and tighten it clockwise (see 5. Cleaning).
4. Screw stepped nipples ⑦ on to the pump inlet ⑤ and pump outlet ⑧.
5. Connect the pump inlet ⑤ to the water reservoir with a hose (1/2" or 3/4"). **The level in the water reservoir must be higher than the pump inlet ⑤.**
6. Connect the pump outlet ⑧ to the spring / gargoyles with a hose (1/2" or 3/4").
7. Fill the hose to the pump inlet ⑤ with water.
8. Insert the pump plug into a mains socket.  
**Caution: The pump will start immediately.**
9. Use the flow control ③ to set the desired water flow for the spring.

## 4. Storage

### Storage:



The fountain pump must be stored out of the reach of children.

1. Before the frosty season begins, ensure the fountain pump has been cleaned and is stored indoors.
2. To avoid difficulties when starting up in the spring, we recommend storing the pump in a frost-free location in a container filled with water.

*The mains plug must not be submerged.*

### Disposal:

*(in accordance with  
RL2002/96/EC)*



The product must not be added to normal household waste. It must be disposed of in accordance with local environmental regulations.

## 5. Cleaning



**DANGER! Electric Shock!**

**Risk of injury due to electric shock.**

**→ Before cleaning the pump, unplug it from the mains.**

**Do not use any hard tools or aggressive cleaners on the pump.**

***Cleaning the  
RP 240 / 300 / 420:***

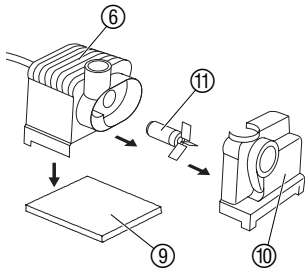

1. Remove foam filter ⑨ by pulling down and clean it.
2. Push off the pump housing ⑩ on the pressure spigot of the motor housing ⑥.
3. Take the impeller ⑪ out of the motor housing ⑥ and clean it.
4. Push the cleaned impeller ⑪ back into the motor housing ⑥.
5. Push the pump housing ⑩ back onto the motor housing ⑥.



## Cleaning the RP 600:

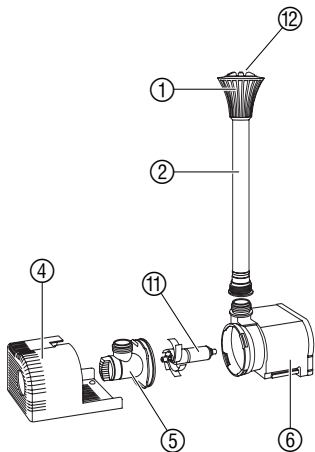

1. Pull off the fountain socket ① and nozzle tube ②.
2. Unscrew the fountain insert ⑫ and clean it.
3. Remove the filter housing ④ from the motor housing ⑥, and clean it.
4. Turn the pump inlet ⑤ anticlockwise and pull it vertically off the motor housing ⑥ (bayonet socket).
5. Take the impeller ⑪ out of the motor housing ⑥ and clean it.
6. Push the cleaned impeller ⑪ back into the motor housing ⑥.
7. Push the pump inlet ⑤ vertically onto the motor housing ⑥ and tighten it clockwise. (If the pump is to suck from underneath, the thread must face downwards).
8. Push the filter housing ④ back on to the motor housing ⑥.
9. Screw the desired fountain insert ⑫ into the fountain socket ①.
10. Plug the fountain socket ① and nozzle tube ② back into place.

## 6. Troubleshooting



**WARNING! Electric Shock!**

**Risk of injury due to electric shock.**

**→ Disconnect the fountain pump at the mains before rectifying any faults.**

<b>Problem</b>	<b>Probable Cause</b>	<b>Remedy</b>
<b>The pump delivers no water</b>	Mains plug not plugged in.	→ Plug in the mains plug.
	Impeller unit is blocked.	→ Clean pump.
	Impeller running in the wrong direction due to insufficient water.	→ Disconnect from the mains and top up with water.
<b>The pump delivers a reduced water flow</b>	Foam filter / filter housing dirty.	→ Clean the foam filter / filter housing.

**CAUTION!**



**Work on the electrical parts must only be carried out by GARDENA Service Centres.**

If other faults occur, please contact GARDENA Service.

## 7. Accessories

<b>GARDENA Underwater lights UL 20/UL 20 S Set</b>	Illuminates fountains from below or above the surface of the water	<b>Art. 7952</b> <b>Art. 7958</b>
<b>GARDENA radio control set</b>	Start water features and lighting from the terrace or your living room.	<b>Art. 7874</b>

## 8. Technical data

	<b>RP 240</b> (Art. 7834)	<b>RP 300</b> (Art. 7835)	<b>RP 420</b>	<b>RP 600</b> (Art. 7838)
<b>Mains voltage / mains frequency</b>	230 V / 50 Hz	230 V / 50 Hz	230 V / 50 Hz	230 V / 50 Hz
<b>Rated power</b>	3.5 W	4.5 W	5 W	8 W
<b>Power cable</b>	1.5 m H03 VV	1.5 m H03 VV	3 m H05 RNF	1,5 m H03 VV
<b>Max. Flow</b>	240 l/h	300 l/h	420 l/h	600 l/h
<b>Max. delivery head</b>	0.5 m	0.7 m	0.75 m	1.2 m
<b>Max. submersion depth</b>	0.4 m	0.4 m	0.4 m	1.0 m
<b>Pump connection</b>	G 1/2	G 1/2	G 1/2	G 1/2
<b>Media temperature</b>	4 °C – 35 °C	4 °C – 35 °C	4 °C – 35 °C	4 °C – 35 °C

## 9. Service / Warranty

---

### *Warranty*

GARDENA guarantees this product for 3 years from date of purchase. This guarantee covers all serious defects of the unit that can be proved to be material or manufacturing faults. Under warranty we will either replace the unit or repair it free of charge if the following conditions apply:

- The unit must have been handled properly and in keeping with the requirements of the operating instructions.
- Neither the purchaser or a non-authorized third party have attempted to repair the unit.

The feed impeller is a wearing part and is not covered by the warranty.

This manufacturer's guarantee does not affect the user's existing warranty claims against the dealer/seller.

If you have any problems with your Fountain Pump Set, please contact our Service or return the defective unit together with a short description of the problem – in case of guarantee, with a copy of the receipt – postage paid to one of the GARDENA Service Centres listed on the back of this leaflet.

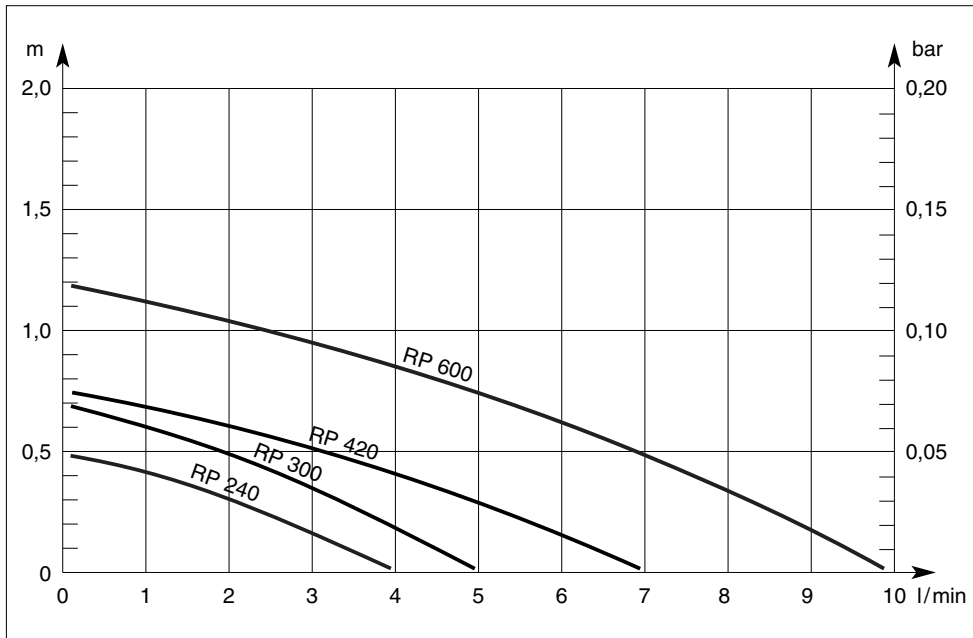

**D** **Produkthaftung**

Wir weisen ausdrücklich darauf hin, dass wir nach dem Produkthaftungsgesetz nicht für durch unsere Geräte hervorgerufene Schäden einzustehen haben, sofern diese durch unsachgemäße Reparatur verursacht oder bei einem Teileaustausch nicht unsere Original GARDENA Teile oder von uns freigegebene Teile verwendet werden und die Reparatur nicht vom GARDENA Service oder dem autorisierten Fachmann durchgeführt wird. Entsprechendes gilt für Ergänzungssteile und Zubehör.

**GB** **Product Liability**

We expressly point out that, in accordance with the product liability law, we are not liable for any damage caused by our units if it is due to improper repair or if parts exchanged are not original GARDENA parts or parts approved by us, and, if the repairs were not carried out by a GARDENA Service Centre or an authorised specialist. The same applies to spare parts and accessories.

**F** **Responsabilité**

Nous vous signalons expressément que GARDENA n'est pas responsable des dommages causés par ses appareils, dans la mesure où ces dommages seraient causés suite à une réparation non conforme, dans la mesure où, lors d'un échange de pièces, les pièces d'origine GARDENA n'auraient pas été utilisées, ou si la réparation n'a pas été effectuée par le Service Après-Vente GARDENA ou l'un des Centres SAV agréés GARDENA. Ceci est également valable pour tout ajout de pièces et d'accessoires autres que ceux préconisés par GARDENA.

**NL** **Productaansprakelijkheid**

Wij wijzen er nadrukkelijk op, dat wij op grond van de wet aansprakelijkheid voor producten niet aansprakelijk zijn voor schade ontstaan door onze apparaten, indien deze door onvakkundige reparatie veroorzaakt zijn, of er bij het uitwisselen van onderdelen geen gebruik gemaakt werd van onze originele GARDENA onderdelen of door ons vrijgegeven onderdelen en de reparatie niet door de GARDENA technische dienst of de bevoegde vakman uitgevoerd werd. Ditzelfde geldt voor extra-onderdelen en accessoires.

**DK Produktansvar**

Vi gør udtrykkeligt opmærksom på at i henhold til produktansvarsloven er vi ikke ansvarlige for skader forårsaget af vores udstyr, hvis det skyldes uautoriserede reparationer eller hvis dele er skiftet ud og der ikke er anvendt originale GARDENA dele eller dele godkendt af os, eller hvis reparationerne ikke er udført af GARDENA-service eller en autoriseret fagmand. Det samme gælder for ekstra udstyr og tilbehør.

**D EU-Konformittserklring Maschinenverordnung (9. GSGVO) / EMVG / Niedersp. RL**

Der Unterzeichnete GARDENA Manufacturing GmbH, Hans-Lorenser-Str. 40, D-89079 Ulm, besttigt, dass das nachfolgend bezeichnete Gert in der von uns in Verkehr gebrachten Ausfhrung die Anforderungen der harmonisierten EU-Richtlinien, EU-Sicherheitsstandards und produktspezifischen Standards erfllt. Bei einer nicht mit uns abgestimmten nderung des Gertes verliert diese Erklrung ihre Gltigkeit.

**GB EU Certificate of Conformity**

The undersigned GARDENA Manufacturing GmbH, Hans-Lorenser-Str. 40, D-89079 Ulm, hereby certifies that, when leaving our factory, the unit indicated below is in accordance with the harmonised EU guidelines, EU standards of safety and product specific standards. This certificate becomes void if the unit is modified without our approval.

**F Certificat de conformit aux directives europennes**

Le constructeur, soussign : GARDENA Manufacturing GmbH, Hans-Lorenser-Str. 40, D-89079 Ulm, dclare qu' la sortie de ses usines le matriel neuf dsign ci-dessous tait conforme aux prescriptions des directives europennes nonces ci-aprs et conforme aux rgles de scurit et autres rgles qui lui sont applicables dans le cadre de l'Union europenne. Toute modification porte sur ce produit sans l'accord express de GARDENA supprime la validit de ce certificat.

**NL EU-overeenstemmingsverklaring**

Ondergetekende GARDENA Manufacturing GmbH, Hans-Lorenser-Str. 40, D-89079 Ulm, bevestigt, dat het volgende genoemde apparaat in de door ons in de handel gebrachte uitvoering voldoet aan de eis van, en in overeenstemming is met de EU-richtlijnen, de EU-veiligheidsstandaard en de voor het product specifieke standaard. Bij een niet met ons afgestemde verandering aan het apparaat verliest deze verklaring haar geldigheid.

Bezeichnung des Gerätes:	Zimmerbrunnenpumpe	Typ:	Art.-Nr.:
Description of the units:	Indoor Fountain Pump	Type:	Art. No.:
Désignación del matériel :	Pompe pour fontaine d'intérieur	Type : <b>RP 240</b>	Référence : <b>7834</b>
Omschrijving van de apparaten:	Binnenshuis-fonteinpomp	Tip: <b>RP 300</b>	Art. nr.: <b>7835</b>
Produktbeskrivning:	Pump för inomhusfontän	Tip: <b>RP 420</b>	Art.nr. : <b>7838</b>
Descrizione dei prodotti:	Pompa per fontana da interni	Modello: <b>RP 600</b>	Art. : <b>7838</b>
Descripción de la mercancía:	Bomba para fuente de interior	Tipo:	Art. Nº:
Descrição do aparelho:	Bomba para fontes interiores	Tipo:	Art. Nº:
Beskrivelse af enhederne:	Springvandspumpe indendørs	Type:	Varenr. :
EU-Richtlinien:		Anbringungsyear der CE-Kennzeichnung:	
EU directives:	<b>98/37/EC</b>	Year of CE marking:	
Directives européennes :		Date d'apposition du marquage CE :	
EU-richtlijnen:	<b>89/336/EC</b>	Installatiejaar van de CE-aanduiding:	
EU direktiv:		CE-Märkningsår:	<b>2005</b>
Direttive UE:	<b>73/23/EC</b>	Anno di rilascio della certificazione CE:	
Normativa UE:		Colocación del distintivo CE:	
Directrizes da UE:	<b>93/68/EC</b>	Ano de marcação pela CE:	
EU Retningslinier:		CE-Mærkningsår:	
Ulm, den 01.06.2005	Technische Leitung	Ulm, 01.06.2005	Teknisk direktør
Ulm, 01.06.2005	Technical Dept. Manager		
Fait à Ulm, le 11.06.2005	Direction technique		
Ulm, 01-06-2005	Hoofd technische dienst		
Ulm, 2005.06.01.	Technical Director		
Ulm, 01.06.2005	Direzione Tecnica		
Ulm, 01.06.2005	Dirección Técnica		
Ulm, 01.06.2005	Director Técnico		
			
			Peter Lameli



**Deutschland / Germany**

GARDENA  
Manufacturing GmbH  
Service Center  
Hans-Lorenser-Straße 40  
D-89079 Ulm  
Produktfragen:  
(+49) 731 490-123  
Reparaturen:  
(+49) 731 490-290  
service@gardena.com

**Argentina**

Argensem® S.A.  
Calle Colonia Japonesa s/n  
(1625) Loma Verde  
Escobar, Buenos Aires  
Phone: (+54) 34 88 49 40 40  
info@argensem.com.ar

**Australia**

Nylex Consumer Products  
50-70 Stanley Drive  
Somerton, Victoria, 3062  
Phone: (+61) 1800 658 276  
spare.parts@nylex.com.au

**Austria / Österreich**

GARDENA  
Österreich Ges.m.b.H.  
Stettnerweg 11-15  
2100 Korneuburg  
Tel.: (+43) 22 62 7 45 45 36  
kundendienst@gardena.at

**Belgium**

GARDENA Belgium NV/SA  
Sterrebeekstraat 163  
1930 Zaventem  
Phone: (+32) 2 720 92 12  
Mail: info@gardena.be

**Brazil**

Palash Comércio e  
Importação Ltda.  
Rua América Brasileira,  
2414 - Chácara Sto Antonio  
São Paulo - SP - Brasil -  
CEP 04715-005  
Phone: (+55) 11 5181-0909  
eduardo@palash.com.br

**Bulgaria**

DENEX LTD.  
2 Luis Ahalier Str. - 7th floor  
Sofia 1404  
Phone: (+359) 2 958 18 21  
office@denex-bg.com

**Canada**

GARDENA Canada Ltd.  
100 Summerlea Road  
Brampton, Ontario L6T 4X3  
Phone: (+1) 905 792 93 30  
info@gardenacanada.com

**Chile**

Antonio Martinic y Cia Ltda.  
Cassillas 272  
Centro de Cassillas  
Santiago de Chile  
Phone: (+56) 2 20 10 708  
garfar\_cl@yahoo.com

**Costa Rica**

Compania Exim  
Euroiberoamericana S.A.  
Los Colegios, Moravia,  
200 metros al Sur del Colegio  
Saint Francis - San José  
Phone: (+506) 297 68 83  
exim\_euro@racsa.co.cr

**Croatia**

KLIS d.o.o.  
Stanciceva 79, 10419 Vukovina  
Phone: (+385) 1 622 777 0  
gardena@klis-trgovina.hr

**Cyprus**

FARMOKIPIKI LTD  
P.O. Box 7098  
74, Digeni Akrita Ave.  
1641 Nicosia  
Phone: (+357) 22 75 47 62  
condam@spidernet.com.cy

**Czech Republic**

GARDENA spol. s r.o.  
Řípská 20 a, č.p. 1153  
627 00 Brno  
Phone: (+420) 800 100 425  
gardena@gardenabrno.cz

**Denmark**

GARDENA Norden AB  
Salgsafdeling Danmark  
Box 9003, S-200 39 Malmö  
info@gardena.dk

**Finland**

Habitec Oy  
Martinkyläntie 52  
01720 Vantaa

**France**

GARDENA  
PARIS NORD 2  
69, rue de la Belle Etoile  
BP 57080  
ROISSY EN FRANCE  
95948 ROISSY CDG CEDEX  
Tél. (+33) 0826 101 455  
service.consommateurs@  
gardena.fr

**Great Britain**

GARDENA UK Ltd.  
27-28 Brenkley Way  
Blezard Business Park  
Seaton Burn  
Newcastle upon Tyne  
NE13 6DS  
info@gardena.co.uk

**Greece**

Agrokip  
Psomadopoulos S.A.  
Ifaistou 33A  
Industrial Area Koropi  
194 00 Athens Greece  
V.A.T. EL093474846  
Phone: (+30) 210 66 20 225  
service@agrokip.gr  
www.agrokip.gr

**Hungary**

GARDENA  
Magyarország Kft.  
Késmárk utca 22  
1158 Budapest  
Phone: (+36) 80 20 40 33  
gardena@gardena.hu

**Iceland**

Ó. Johnson & Kaaber  
Tunguhalsi 1  
110 Reykjavik  
ooj@ojk.is

**Ireland**

Michael McLoughlin & Sons  
Hardware Limited  
Long Mile Road  
Dublin 12

**Italy**

GARDENA Italia S.p.A.  
Via Donizetti 22  
20020 Lainate (Mi)  
Phone: (+39) 02.93.94.79.1  
info@gardenaitalia.it

**Japan**

KAKUICHI Co. Ltd.  
Sumitomo Realty &  
Development Kojimachi  
BLDG., 8F, 5-1 Nibanccyo,  
Chiyoda-ku, Tokyo 102-0084  
Phone: (+81) 33 264 4721  
m\_ishihara@kaku-ichi.co.jp

**Luxembourg**

Magasins Jules Neuberg  
Boîte postale 12  
L-2010 Luxembourg  
Phone: (+352) 40 14 01  
info@neuberg.lu

**Netherlands**

GARDENA Nederland B.V.  
Postbus 50176  
1305 AD ALMERE  
Phone: (+31) 36 521 00 00  
info@gardena.nl

**Neth. Antilles**

Jonka Enterprises N.V.  
Sta. Rosa Weg 196  
P.O. Box 8200, Curaçao  
Phone: (+599) 9 767 66 55  
pgm@jonka.com

**New Zealand**

NYLEX New Zealand Limited  
Building 2, 118 Savill Drive  
Mangere, Auckland  
Phone: (+64) 9 270 1806  
lena.chapman@nylex.com.au

**Norway**

GARDENA Norden AB  
Salgskontor Norge  
Karihaugveien 89  
1086 Oslo  
info@gardena.no

**Poland**

GARDENA Polska Sp. z o.o.  
Szymanów 9 d  
05-532 Baniocza  
Phone: (+48) 22 727 56 90  
gardena@gardena.pl

**Portugal**

GARDENA Portugal Lda.  
Recta da Granja do Marquês  
Edif. GARDENA Algueirão  
2725-596 Mem Martins  
Phone: (+351) 21 922 85 30  
info@gardena.pt

**Romania**

MADEX INTERNATIONAL SRL  
Soseaua Odaii 117-123,  
Sector 1,  
București, RO 013603  
Phone: (+40) 21 352 76 03  
madex@ines.ro

**Russia / Россия**

ООО ГАРДЕНА РУС  
123007, г. Москва  
Хорошевское шоссе, д. 32А  
Тел.: (+7) 495 247 25 10  
info@gardena-rus.ru

**Singapore**

Hy - Ray PRIVATE LIMITED  
40 Jalan Pemimpin  
#02-08 Tat Ann Building  
Singapore 577185  
Phone: (+65) 6253 2277  
hyray@singnet.com.sg

**Slovak Republic**

GARDENA Slovensko, s.r.o.  
Panónska cesta 17  
851 04 Bratislava  
Phone: (+421) 263 453 722  
info@gardena.sk

**Slovenia**

GARDENA d.o.o.  
Brodišče 15  
1236 Trzin  
Phone: (+386) 1 580 93 32  
servis@gardena.si

**South Africa**

GARDENA  
South Africa (Pty.) Ltd.  
P.O. Box 11534  
Vorna Valley 1686  
Phone: (+27) 11 315 02 23  
sales@gardena.co.za

**Spain**

GARDENA IBÉRICA S.L.U.  
C/ Basauri, nº 6  
La Florida  
28023 Madrid  
Phone: (+34) 91 708 05 00  
atencioncliente@gardena.es

**Sweden**

GARDENA Norden AB  
Försäljningskontor Sverige  
Box 9003  
200 39 Malmö  
info@gardena.se

**Switzerland / Schweiz**

GARDENA (Schweiz) AG  
Bitziberg 1  
8184 Bachenbülach  
Phone: (+41) 848 800 464  
info@gardena.ch

**Turkey**

GARDENA / Dost Diş Ticaret  
Mümessillik A.Ş. Sanayi  
Çad. Adil Sokak No. 1  
Kartal - İstanbul  
Phone: (+90) 216 38 93 939  
info@gardena-dost.com.tr

**Ukraine / Украина**

ALTSEST JSC  
4 Petropavlivska Street  
Petropavlivska, Borschahivka  
Town, Kyivo Svyatoshyh Region  
08130, Ukraine  
Phone: (+380) 44 459 57 03  
upyr@altsest.kiev.ua

**USA**

Melnor Inc.  
3085 Shawnee Drive  
Winchester, VA 22604  
Phone: (+1) 540 722-9080  
service\_us@melnor.com

7834-20.960.11/1006  
© GARDENA  
Manufacturing GmbH  
D-89070 Ulm  
http://www.gardena.com

## Free Manuals Download Website

<http://myh66.com>

<http://usermanuals.us>

<http://www.somanuals.com>

<http://www.4manuals.cc>

<http://www.manual-lib.com>

<http://www.404manual.com>

<http://www.luxmanual.com>

<http://aubethermostatmanual.com>

Golf course search by state

<http://golfingnear.com>

Email search by domain

<http://emailbydomain.com>

Auto manuals search

<http://auto.somanuals.com>

TV manuals search

<http://tv.somanuals.com>