

SANYO

INSTRUCTION MANUAL

Digital Movie Camera

Xacti

VPC-C6EX
VPC-C6EXE
VPC-C6E
VPC-C6

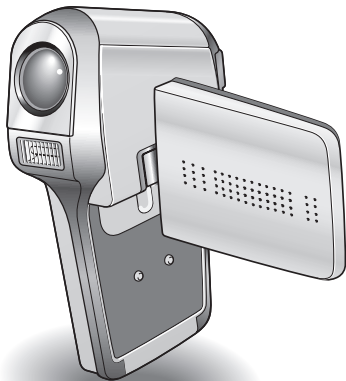

Important note

This manual explains how to safely operate the VPC-C6EX, VPC-C6EXE, VPC-C6E and VPC-C6.

Any information regarding only one of these products will be labeled as such.

Please read these instructions carefully before using the camera.
Make sure to read and understand the separate booklet "SAFETY MANUAL".
Keep this manual in a safe place for later reference.

Download from [Www.Somanuals.com](http://www.Somanuals.com). All Manuals Search And Download.

Warning

TO PREVENT THE RISK OF FIRE OR ELECTRIC SHOCK, DO NOT EXPOSE THIS APPLIANCE TO RAIN OR MOISTURE

FOR AMERICAN USERS

The following advisory is included in accordance with the laws of the State of California (USA):

WARNING:

This product contains chemicals, including lead, known to the State of California to cause cancer, birth defects or other reproductive harm. **Wash hands after handling.**

- This equipment has been tested and found to comply with the limits for a Class B digital device, pursuant to Part 15 of the FCC Rules. These limits are designed to provide reasonable protection against harmful interference in a residential installation. This equipment generates, uses and can radiate radio frequency energy and, if not installed and used in accordance with the instructions, may cause harmful interference to radio communications. However, there is no guarantee that interference will not occur in a particular installation. If this equipment does cause harmful interference to radio or television reception, which can be determined by turning the equipment off and on, the user is encouraged to try to correct the interference by one or more of the following measures:
 - Reorient or relocate the receiving antenna.
 - Increase the separation between the equipment and receiver.
 - Connect the equipment into an outlet on a circuit different from that to which the receiver is connected.
 - Consult the dealer or an experienced radio/TV technician for help.
- Changes or modifications not expressly approved by the party responsible for compliance could void the user's authority to operate the equipment.

Declaration of Conformity

Model number: VPC-C6

Trade Name: SANYO

Responsible party: SANYO FISHER COMPANY

Address: 21605 Plummer Street, Chatsworth, California 91311

Telephone No.: (818) 998-7322

This device complies with Part 15 of the FCC Rules. Operation is subject to the following two conditions:

- (1) this device may not cause harmful interference, and
- (2) this device must accept any interference received, including interference that may cause undesired operation.

FOR CANADIAN USERS

- This Class B digital apparatus complies with Canadian ICES-003.

FOR EU USERS



Note:

- This symbol mark and recycle system apply only to EU countries and do not apply to countries in other areas of the world.

Your SANYO product is designed and manufactured with high quality materials and components which can be recycled and reused.

This symbol means that electrical and electronic equipment, at their end-of-life, should be disposed of separately from your household waste.

Please dispose of this equipment at your local community waste collection/recycling centre.

In the European Union there are separate collection systems for used electrical and electronic products.

Please help us to conserve the environment we live in!

Symbols used in this manual

- HINT** Points giving some extended instructions or special points to pay attention to.
- CAUTION** Points that require special attention.
- (page xx)** Refer to the page indicated for detailed information.

You may find the answers to questions or problems concerning camera operation in the sections "COMMONLY ASKED QUESTIONS" (page 155) and "TROUBLESHOOTING" (page 162).

GETTING UP AND RUNNING

Install the card

- 1 Insert the card.

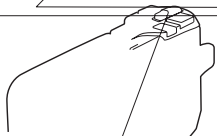

-
- 2 Connect the AC adaptor to the camera.

Shooting

■ Video clip recording

- 1** Open the monitor unit, and press the **ON/OFF** button for at least 1 second to turn the camera on.
- 2** Set the main switch to **REC.**
- 3** Press the video clip recording button [].
 - Recording begins.
 - To stop recording, press the video clip recording

Playback

■ Video clip playback

1 Set the main switch to PLAY.

- The display switches to the Playback Screen.
- Toggle the SET button to the left or right to display the video clip you wish to play back.
- Video clips are indicated by a video clip pattern along the top and bottom of the screen.

2 Press the SET button.

- Playback of the selected video clip begins.
- When the main switch is moved to REC, the display changes to the Shooting Screen.

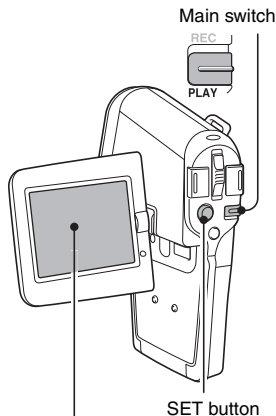

■ Still image playback

1 Set the main switch to PLAY.

- The display switches to the Playback Screen.
- To view other images, toggle the SET button to the left or right.
- When the main switch is moved to REC, the display changes to the Shooting Screen.

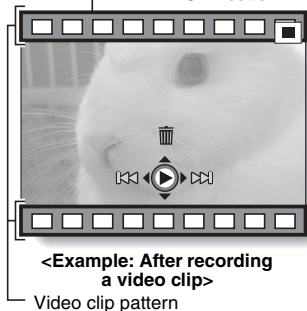

When you are finished using the camera...

Press the ON/OFF button to turn the camera off.

QUICK SEARCH BY OPERATION

Your camera has an abundance of convenient features and functions. From creating precisely the photo you want, to viewing images using various techniques, you can locate the exact operation for your purposes in the following table.

	Basic operation	Convenient functions	Additional functions
Shooting/recording	Getting started shooting/recording <ul style="list-style-type: none">• “Recording video clips” on page 34• “Capturing still images” on page 36• “Shoot a still image while recording a video clip” on page 38• “MAKE AN AUDIO RECORDING” on page 41	Log the date and time of your photos <ul style="list-style-type: none">• “DATE AND TIME SETTING” on page 107 Zoom in on the subject <ul style="list-style-type: none">• “Using the zoom” on page 39 Take vertical (portrait) format photos <ul style="list-style-type: none">• “Still image mode (resolution) setting” on page 56 Close-up photography <ul style="list-style-type: none">• “FOCUS RANGE” (super macro mode) on page 66	For more accurate focus <ul style="list-style-type: none">• “FOCUS RANGE” (manual focus) page 66 Set the focus to a narrow range <ul style="list-style-type: none">• “FOCUS AREA SETTING” on page 68
	Optimize the photo quality <ul style="list-style-type: none">• “Video clip mode (image quality) setting” on page 55• “Still image mode (resolution) setting” on page 56	Reduce video clip flicker <ul style="list-style-type: none">• “FLICKER-REDUCTION” on page 117 Set the camera’s color/contrast characteristics <ul style="list-style-type: none">• “ADJUST THE IMAGE QUALITY” on page 116	

	Basic operation	Convenient functions	Additional functions
Shooting/recording	Capture fast-moving subjects		
	<ul style="list-style-type: none"> • “SCENE SELECT” (sports mode) on page 57 		
	Shoot in dark conditions		
	<ul style="list-style-type: none"> • “Exposure correction” on page 40 • “FLASH SETTING” on page 60 • “SCENE SELECT” (night view mode/fireworks mode/lamp mode) on page 57 		
			Increase the camera’s sensitivity
			<ul style="list-style-type: none"> • “ISO SENSITIVITY” on page 70
	Photographing people		
	<ul style="list-style-type: none"> • “SCENE SELECT” (portrait mode/night view mode) on page 57 • “FILTERS” (cosmetic filter) on page 59 		
	Photographing landscapes		
	<ul style="list-style-type: none"> • “SCENE SELECT” (landscape mode) on page 57 		
Take a self-photo			
<ul style="list-style-type: none"> • “SELF-TIMER” on page 62 			
	Make images lighter or darker	Measure the brightness of a specific area	
	<ul style="list-style-type: none"> • “Exposure correction” on page 40 	<ul style="list-style-type: none"> • “LIGHT-MEASURING MODE SETTING” on page 69 	
		Adjust the camera’s sensitivity	
		<ul style="list-style-type: none"> • “ISO SENSITIVITY” on page 70 	
	Change the color of the images	Make white appear natural	
	<ul style="list-style-type: none"> • “FILTERS” (monochrome filter/sepia filter) on page 59 	<ul style="list-style-type: none"> • “WHITE BALANCE” on page 71 	

QUICK SEARCH BY OPERATION

	Basic operation	Convenient functions	Additional functions
Playback	Getting started viewing images <ul style="list-style-type: none"> • “Playing back a video clip” on page 46 	Adjust the speaker volume <ul style="list-style-type: none"> • “PLAYBACK VOLUME” on page 78 	Smooth out video clip playback <ul style="list-style-type: none"> • “SMOOTH PLAYBACK” on page 102
	<ul style="list-style-type: none"> • “VIEWING IMAGES” on page 43 	Search for image/ audio data <ul style="list-style-type: none"> • “9-image display playback” on page 44 Magnify an image <ul style="list-style-type: none"> • “Magnifying (zooming in) the image” on page 45 	Change the angle of view <ul style="list-style-type: none"> • “ROTATE IMAGE” on page 90
	<ul style="list-style-type: none"> • “PLAYING BACK AUDIO DATA” on page 48 	Adjust the speaker volume <ul style="list-style-type: none"> • “PLAYBACK VOLUME” on page 78 	
	Slideshow playback <ul style="list-style-type: none"> • “PLAYBACK MODE” on page 77 		
	Adjust the LCD monitor brightness <ul style="list-style-type: none"> • “LCD MONITOR BRIGHTNESS” on page 119 		
	Playback on a TV <ul style="list-style-type: none"> • “CONNECTING TO A TV” on page 137 	Set the TV system <ul style="list-style-type: none"> • “TV OUTPUT SETTING” on page 121 	
Data managing/processing	Search for image/audio data <ul style="list-style-type: none"> • “9-image display playback” on page 44 		
	Delete data <ul style="list-style-type: none"> • “ERASING DATA” on page 81 	Protect images from accidental erasure <ul style="list-style-type: none"> • “IMAGE PROTECT” on page 79 Format a card <ul style="list-style-type: none"> • “FORMATTING A CARD” on page 128 	
	Edit the red-eye phenomenon in photos <ul style="list-style-type: none"> • “RED-EYE CORRECTION” on page 92 		
	Delete a part of a video clip and join video clips <ul style="list-style-type: none"> • “EDITING VIDEO CLIPS” on page 95 		
	Specify the number of prints, index print, and date imprint <ul style="list-style-type: none"> • “PRINT SETTINGS” on page 83 		
	View the settings that were in effect when the image/audio data was recorded <ul style="list-style-type: none"> • “DISPLAYING IMAGE PROPERTIES (INFORMATION SCREEN)” on page 103 		

CONTENTS

GETTING UP AND RUNNING	iii
QUICK SEARCH BY OPERATION	1
CONTENTS	4
CHECKING THE INCLUDED ACCESSORIES	7
GETTING THE MOST OUT OF YOUR CAMERA	11
SYSTEM MAP	15

■ SETUP

PARTS NAMES	16
INSTALLING THE BATTERY PACK AND CARD	19
POWER FOR THE CAMERA	22
TURNING THE CAMERA ON AND OFF	26
OPERATION BUTTONS	28

■ BASIC OPERATION

BEFORE TAKING PICTURES	30
CAPTURING IMAGES	34
BASIC SHOOTING FUNCTIONS	39
MAKE AN AUDIO RECORDING	41
VIEWING IMAGES	43
PLAYING BACK AUDIO DATA	48

■ SHOOTING

DISPLAYING THE SHOOTING SETTING SCREENS	49
IMAGE QUALITY	55
SCENE SELECT	57
FILTERS	59
FLASH SETTING	60
SELF-TIMER	62
MOTION COMPENSATION (IMAGE STABILIZER)	64
FOCUS RANGE	66
FOCUS AREA SETTING	68
LIGHT-MEASURING MODE SETTING	69
ISO SENSITIVITY	70
WHITE BALANCE	71

CONTENTS

■ **PLAYBACK**

DISPLAYING THE PLAYBACK SETTING SCREENS	73
PLAYBACK MODE	77
PLAYBACK VOLUME	78
IMAGE PROTECT	79
ERASING DATA	81
PRINT SETTINGS	83
ROTATE IMAGE	90
CHANGING IMAGE SIZE (RESIZE)	91
RED-EYE CORRECTION	92
EXTRACTING A STILL IMAGE FROM A VIDEO CLIP	94
EDITING VIDEO CLIPS	95
SMOOTH PLAYBACK	102
DISPLAYING IMAGE PROPERTIES (INFORMATION SCREEN)	103

■ **OPTION SETTINGS**

DISPLAYING THE OPTION SCREEN	104
DATE AND TIME SETTING	107
OPERATION SOUNDS	110
HELP DISPLAY	112
POST-VIEW SETTING	113
WIND NOISE REDUCTION	114
NOISE-REDUCTION FUNCTION	115
ADJUST THE IMAGE QUALITY	116
FLICKER-REDUCTION	117
DIGITAL ZOOM SETTING	118
LCD MONITOR BRIGHTNESS	119
SCREEN LANGUAGE	120
TV OUTPUT SETTING	121
POWER SAVE FUNCTION	123
FILE NO. RESET FUNCTION	125
FORMATTING A CARD	128
RESETTING THE CAMERA SETTINGS	130
CHECKING THE REMAINING CARD MEMORY	131
CHECKING THE REMAINING BATTERY PACK CHARGE	132
USING THE DOCKING STATION	134

■ OTHER DEVICES AND CONNECTIONS

CONNECTING TO A TV	137
PREPARING AND USING THE REMOTE CONTROL UNIT	140
DIRECT PRINTING	145
USING THE CABLE ADAPTOR	154

■ APPENDICES

COMMONLY ASKED QUESTIONS	155
TROUBLESHOOTING	162
SPECIFICATIONS	172
HINTS FOR TAKING PICTURES	182

CHECKING THE INCLUDED ACCESSORIES

- Neckstrap: 1

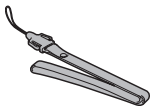

- SANYO Software Pack (CD-ROM): 2

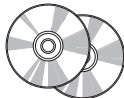

- Li-ion battery pack: 1

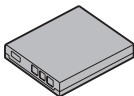

- Docking station: 1

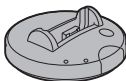

- S-AV interface cable: 1



- USB interface cable: 1



- Remote control unit: 1
A lithium battery (CR2025) is installed at the time of purchase.

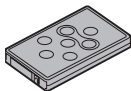

- Lens cap and strap: 1

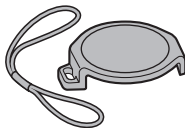

- Cable adaptor: 1

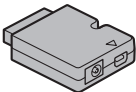

- AC adaptor and power cord: 1

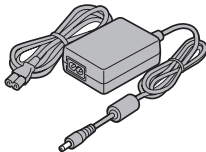

- Camera case: 1

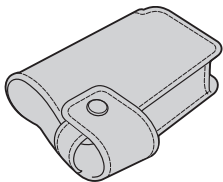

- **“SAFETY MANUAL”**
(safety precautions booklet)
Please read this booklet
carefully before using the
digital camera.



- Quick Guide

■ Camera case

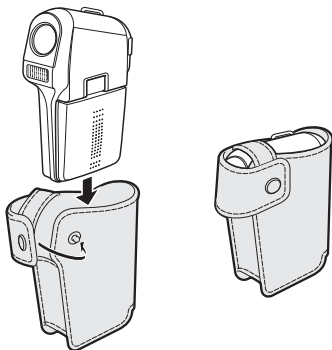

Media cards that can be used with this camera

The type of card that can be inserted into and used with this camera is:

- SD Memory Card

GETTING THE MOST OUT OF YOUR CAMERA

Your movie camera can not only record video clips, you can also take still photos and make audio recordings. For example, you can snap a still image while recording a video clip, or make just an audio recording.

Twin menus for easy operation (see pages 50 and 74)

The novice photographer will have no problem taking beautiful pictures using the easy settings on the PAGE 1 menu.

Of course, the PAGE 2 menu for the experienced photographer provides full control over detailed camera settings.

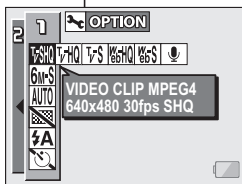
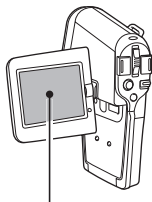

<Example: Shooting
Setting Screen: PAGE 1>

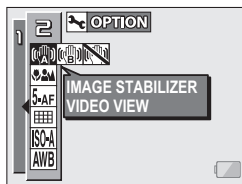

<Example: Shooting
Setting Screen: PAGE 2>

Shooting video clips (page 34)

You expect your camera to record great quality still photos, but you can record 640 × 480-pixel video clips as well. The maximum 30-frames-per-second shooting speed guarantees beautiful, flowing movies for you to enjoy. Another bonus is the capability to record small file sizes that are perfect for uploading to Internet websites.

Capture still shots while recording a video clip (page 38)

Suppose that while you're recording a video clip, there's a scene you'd like to keep as a still photo. Your camera makes it possible to record the still photo without interrupting the video clip recording.



Movable monitor for any shooting angle

The movable LCD monitor lets you shoot from any angle. Hold the camera high to get a great view of a parade, or swivel the monitor around to snap a photo of yourself.



GETTING THE MOST OUT OF YOUR CAMERA

Easy to shoot vertically oriented photos (page 56)

A grip-type camera is compact and very easy to hold securely, but trying to take vertically oriented photos by changing the camera angle is a problem. However, your camera features a vertical shooting mode that allows you to take vertical (portrait) mode still images without having to change the camera angle.

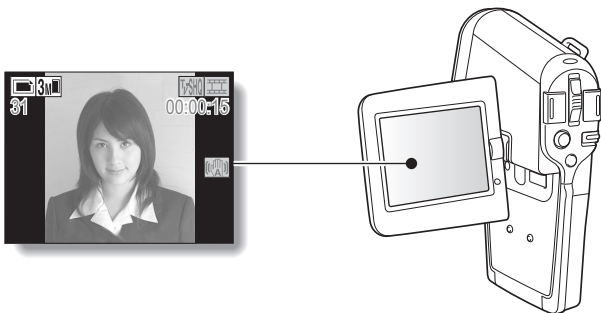

Smooth out the motion during video clip playback: Smooth playback (page 102)

If a video clip was recording while the camera was moving fast, you might see a distracting video flicker when it is played back. For a playback that is comfortably even, you can use the “smooth playback function” to suppress the video flicker.

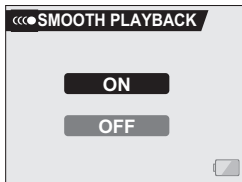

Docking station for easy connection

The docking station simplifies those complicated connections to your TV or computer. Just set the camera in the docking station, and you can view your photos on your TV or computer right away. The remote control unit makes it even more convenient.

<Connecting to a computer (page 7 in the Software Pack instruction manual)>

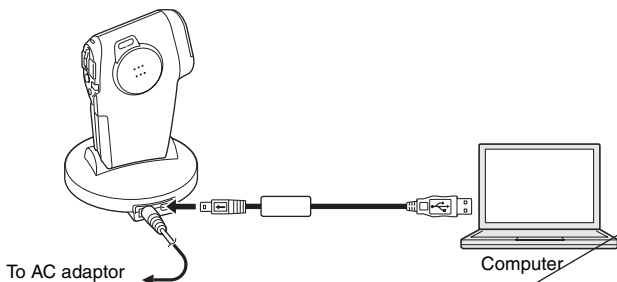

<Connecting to a TV (page 137)>

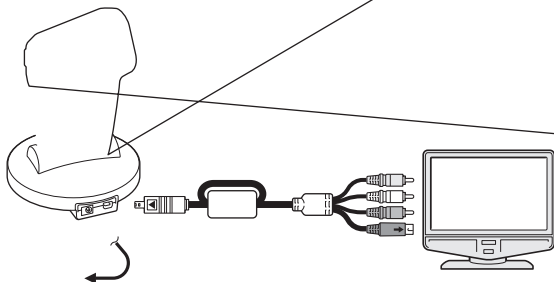

SYSTEM MAP

You can connect the camera to various devices to expand its capabilities.

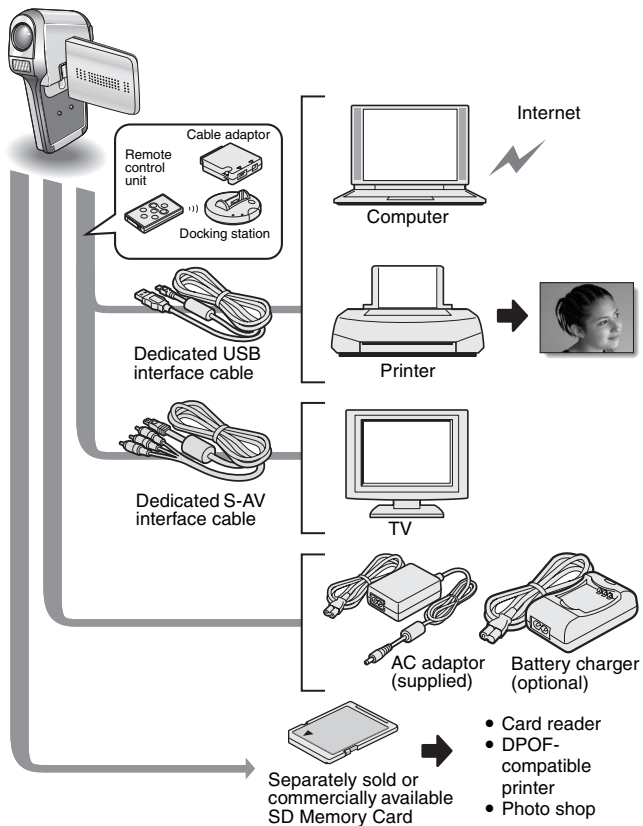

PARTS NAMES

Camera

Front

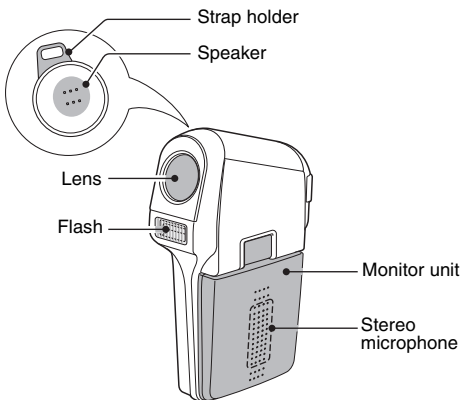

<To open the monitor unit>

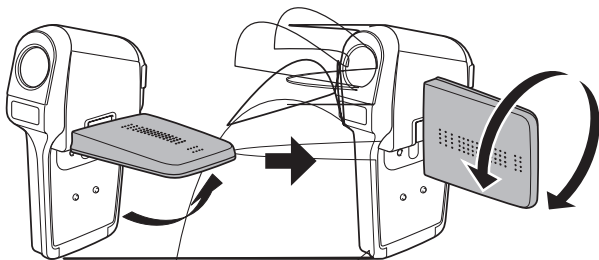

PARTS NAMES

Rear

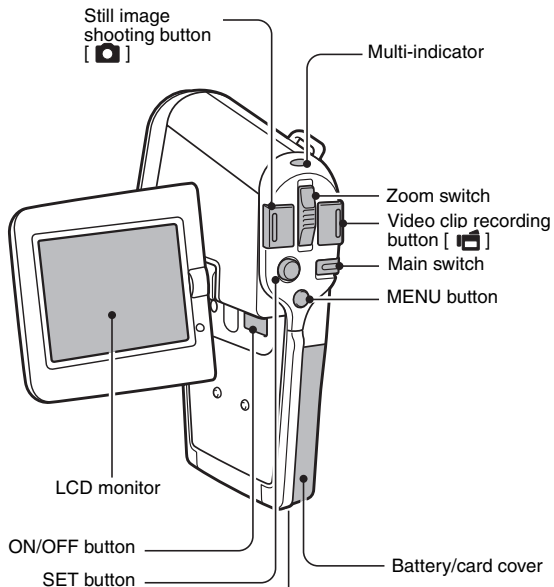

Bottom

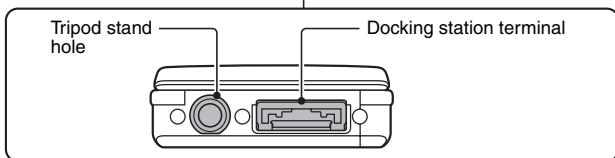

Docking station

Front

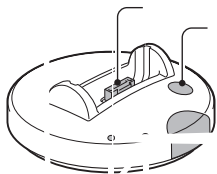

Rear

Cable adaptor

INSTALLING THE BATTERY PACK AND CARD

The card can be used after it has been formatted with the camera (page 128). Make sure that the battery pack and the card orientation are correct.

Install the battery pack

- 1 Open the battery/card cover.**
 - While gently pressing the cover, slide it open.

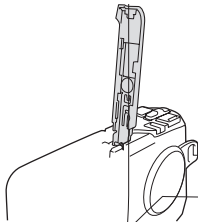

- 2 Insert the battery pack.**
 - Move the latch sideways, insert the battery pack, and firmly push it all the way in ~~to the~~ side

<To remove the battery pack...>

- Slide the latch securing the battery pack to the side, and remove the battery pack.

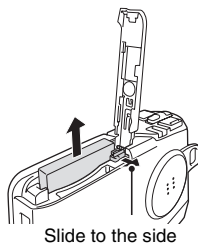

3 Close the battery/card cover.

- Lower the cover, and slide it closed.
- At the time of purchase the battery pack is not charged. Be sure to fully charge the battery pack (pages 22, 24).

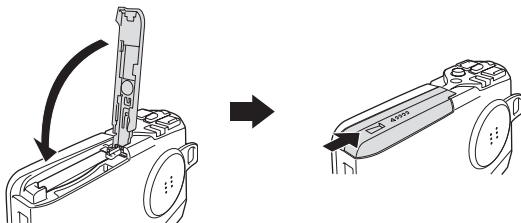

INSTALLING THE BATTERY PACK AND CARD

Install the card

1 Open the battery/card cover.

2 Insert the card.

- Firmly insert the card until it clicks into place.

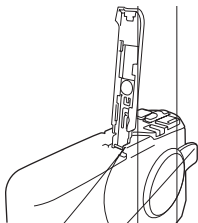

3 Close the battery/card cover.

<When removing the card...>

- To remove the card, press it down, and then release. The card will protrude slightly, and you can then pull it out.

CAUTION

Do not attempt to forcibly remove the card.

- Never remove the card when the multi-indicator is flashing red. In doing so, you risk losing the data stored in the card.

HINT

When not using the camera for a long time, remove the battery pack.

- A small amount of power is still used even if the camera is turned off, and it is therefore recommended that the battery pack be removed from the camera if it is not going to be used for a long time. Note that when the battery pack is removed for a long period, the time and date settings may be cleared. Before using your camera again, be sure to confirm that the camera settings are correct.

POWER FOR THE CAMERA

The supplied AC adaptor is used not only as the camera's AC adaptor, but also to charge the battery installed in the camera.

Using the battery pack

At the time of purchase, the battery pack is not charged. The battery pack must be charged before it can be used in the camera. Also, if the battery power becomes depleted when the camera is being used (see "CHECKING THE REMAINING BATTERY PACK CHARGE" on page 132), it should be recharged as soon as possible.

-
- 1 Install the battery pack in the camera, and attach the cable adaptor to the docking station terminal on the bottom of the camera.**
 - 2 Turn the camera off, and connect the AC adaptor to the DC IN socket of the cable adaptor.**
 - Charging begins when the AC adaptor is connected. However, the camera does not charge when it is set to the shooting mode or PC camera mode.
 - The camera's multi-indicator lights red during charging.
 - Charging will take approximately 90 minutes.
 - The multi-indicator will turn off when the battery pack is fully charged.

POWER FOR THE CAMERA

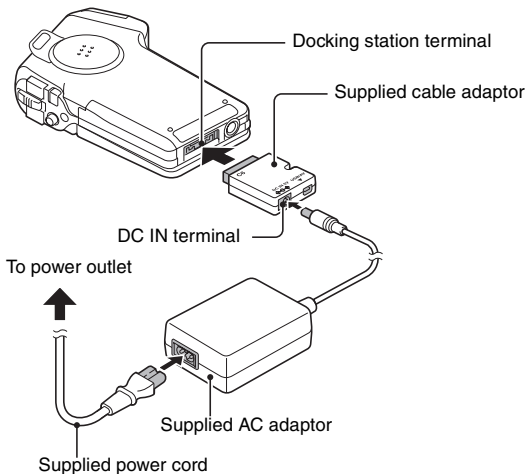

-
- 3** Disconnect the cable adaptor and the AC adaptor after charging is completed.

Using the docking station to charge the battery pack

When the battery pack is installed in your camera, you can recharge it by setting the camera in the docking station (page 134).

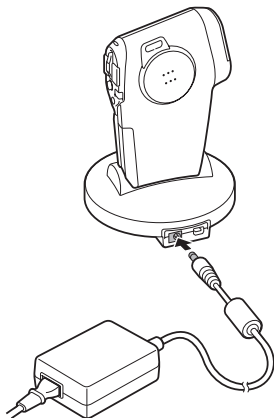

POWER FOR THE CAMERA

Using a power outlet

When the supplied AC adaptor is connected to the camera, power can be supplied from a power outlet.

HINT

About the internal backup battery

- This camera's internal battery serves to maintain the date and time settings, as well as the shooting settings. The backup battery will be fully charged when the battery pack is kept in the camera continuously for about 2 days. In the fully charged state, the backup battery will maintain the camera settings for about 7 days.

TURNING THE CAMERA ON AND OFF

Turning on the camera

- 1 Set the main switch.**
To shoot pictures:
Set to REC
To play back images:
Set to PLAY
- 2 Open the monitor unit.**
- 3 Press the ON/OFF button for about 1 second.**
 - The camera turns on, and an image appears on the LCD monitor.

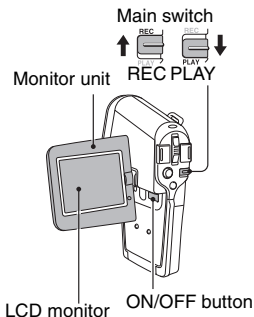

Turning on the camera when the power save (sleep) function is active

In order to preserve battery pack power, the power save (sleep) function will automatically turn off the camera after one minute of no use during shooting, or five minutes of no use during playback (factory-preset setting).

- When the power save function is active, you can restore the power by any of the following methods:
 - Move the main switch.
 - Press the ON/OFF button.
 - Press the Still image shooting/Video clip recording button.
 - Press the SET or MENU button.
 - Press the zoom switch.
- After the power save function has been active for about 1 hour, the camera will switch to the standby mode. In this case, you can restore the power by pressing the ON/OFF button, or by closing and then opening the monitor unit.
- When the AC adaptor is connected, the power save function will become active about 10 minutes after the camera is turned on (factory-preset setting).
- The user can specify the time elapsed before the power save function is activated (page 123).
- When the camera is connected to a computer or printer using the dedicated USB interface cable, the power save function is disabled, and the camera turns off after about 12 hours.

TURNING THE CAMERA ON AND OFF

Turning off the camera

- 1 Press the ON/OFF button for about 2 seconds.**
 - The camera turns off.

HINT

To immediately activate the power save function

- Press the ON/OFF button briefly to activate the power save function.

About the standby mode

- To turn off the camera only briefly, you can close the monitor unit to put the camera in the standby mode. The standby mode uses almost no power. When the monitor unit is opened again, the camera turns on immediately and you are ready to shoot or view images without any delay.

If the icon appears...

- When a picture is taken, the date and time it was captured is recorded with it. When the date and time cannot be recorded with the image because the date and time have not yet been set (page 107), the  icon appears. To have the date and time recorded with images, please make this setting before capturing images.

OPERATION BUTTONS

The procedures to change the camera settings, choose images, etc., are performed by using the SET button to control the LCD monitor display. This operation is used very frequently, so it is best to become familiar with it right away.

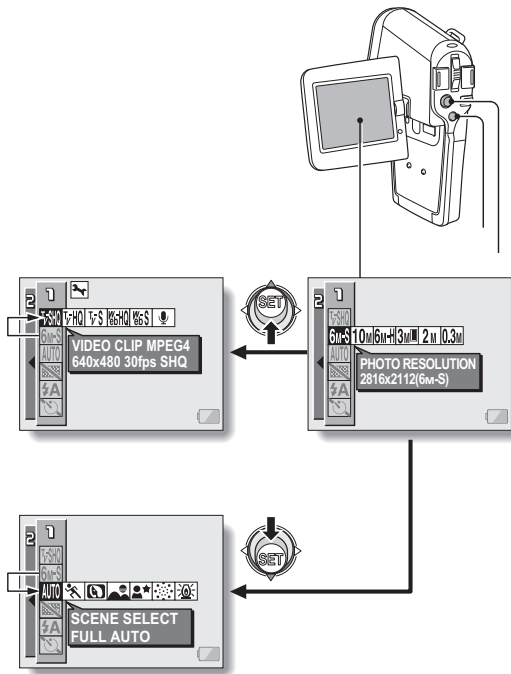

OPERATION BUTTONS

<Select the icon to the left or right>

To select the icon to the right, toggle the SET button to the right.

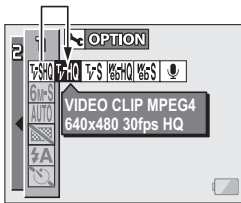

To select the icon to the left, toggle the SET button to the left.

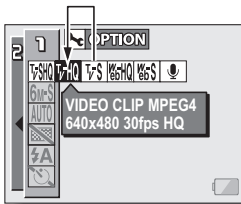

<Actuate the selected icon>

Press the SET button. The selected icon moves to the left end of the lineup.

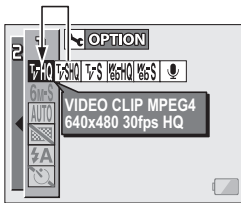

BEFORE TAKING PICTURES

For best results

Hold the camera securely, keeping your elbows close to your body and making sure the camera is stable.



Make sure that the lens and flash are not blocked by your fingers or the strap.

* For shooting vertically oriented still images, you can set the shooting orientation to the vertical (portrait) format still image mode (page 56).

HINT

- Images captured in the still image shooting mode can be rotated when they are played back (page 90).
- When the still image shooting button is pressed halfway, the image in the LCD monitor may waver vertically. This is the result of internal image processing and is not a malfunction. This wavering is not recorded and will not affect your images in any way.
- When the optical zoom is used or when the autofocus is operating, the image may appear to waver, but this is not a malfunction.

BEFORE TAKING PICTURES

Using the autofocus

The autofocus will work in almost all situations; however, there are certain conditions that may cause the autofocus function to not work properly. If the autofocus function is not working properly, set the focus range to capture images (page 66).

■ Conditions that may cause incorrect focus

The following examples are some of the situations where the autofocus function may not work.

- **Subjects with low contrast, very bright subjects at the center of the image or dark subjects or locations**

Use the focus-lock function to lock the focus on an object with contrast at the same distance as the desired subject.

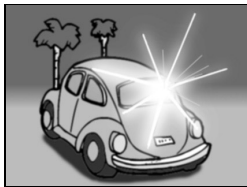

- **Subjects without vertical lines**

Use the focus-lock function to lock the focus while framing the subject vertically, then re-orient the camera to compose a horizontally framed image.

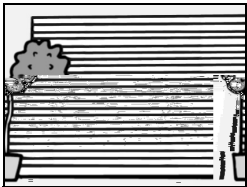

The following examples are some of the situations where the autofocus function may work, but not as desired.

- **When both near and far objects are present**

Use the focus-lock function to lock the focus on an object at the same distance as the desired subject, then reposition the camera to compose the picture.



- **Fast-moving subjects**

Use the focus-lock function to lock the focus on an object at the same distance as the desired subject, then reposition the camera to compose the picture.

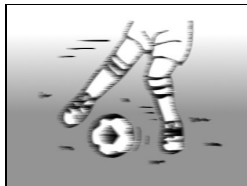

BEFORE TAKING PICTURES

Hints for taking pictures

Muting the operation sounds

- The operation sounds that are generated, for example, when the still image shooting button, MENU button or SET button is pressed, as well as the audio guidance when you switch the mode, can be muted (page 110).

Where is the image and audio data saved?

- All the image and sound data is recorded on the card installed in the camera.

Taking pictures in backlight conditions...

- When taking pictures with the light coming from behind the subject, due to the characteristics of the lens, light lines or ghost patterns (flare phenomenon) may appear in the captured image. In this situation, it is recommended that you avoid taking pictures with the subject lit from behind.

While the image data is being recorded...

- While the multi-indicator is flashing red, the image data is being written to the memory, during which time it is not possible to capture another image. Another image can be captured after the flashing red indicator turns off. However, even when the multi-indicator is flashing red, depending on the camera's internal memory remaining capacity, in some cases the next image can be captured about 2 seconds after shooting.

Checking the last image shot (instant review)

- After shooting a picture, you can immediately view it by pressing the SET button once.
- During instant review of a video clip, normal play, reverse play and pause are available (page 46).
- If you wish to delete the image (for a video clip, it must be in the pause or stop mode), toggle the SET button up to access the delete function.
- You can view other images while the instant review display is showing by toggling the SET button to the left or right.
- Cancel the instant review display (for a video clip, it must be in the stop mode) by toggling the SET button down.

CAPTURING IMAGES

Recording video clips

1 Turn on the camera (page 26).

2 Set the main switch to REC.

3 Press the video clip recording button [].

- Recording begins. During shooting, it is not necessary to continue pressing the video clip recording button.

4 End the recording.

- Press the video clip recording button again to stop recording.

Video clip recording button

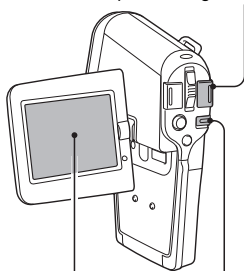

Main switch



Recording time

CAPTURING IMAGES

HINT

Adjusting the LCD monitor brightness

- While the Shooting Screen is active, You can quickly access the screen for adjusting the brightness of the LCD monitor by pressing the MENU button for at least 1 second.

Focus lock during video clip recording

- The autofocus can be set to a fixed focus during video clip recording if you toggle the SET button up. When the autofocus is fixed, the  icon appears on the LCD monitor.
- When the SET button is toggled up again, or the focus range setting (page 66) is changed, the focus lock is released.

The data for a video clip is very large.

- Therefore, be aware that if the video clip is uploaded to a computer to be played back, the computer may not be able to play back the video fast enough, making it appear jerky. (The video will always be displayed properly on the LCD monitor or a television.)

When the remaining card memory becomes 10 percent or less of the total card capacity...

- The remaining memory icon appears on the LCD monitor.
- Depending on the card, shooting may end even before the possible shooting time indicated.

CAUTION

During video clip playback, the sound of a motor is audible...

- During recording, the sound of the optical zoom movement or autofocus movement was recorded. This is not a malfunction.

Capturing still images

1 Turn on the camera (page 26).

2 Set the main switch to REC.

3 Press the still image shooting button [].

- ① **Press the still image shooting button halfway.**
 - The autofocus operates, and the image is focused (focus lock).
- ② **Continue to gently press the still image shooting button all the way.**
 - The shutter releases and the image is captured.
 - You can view the captured image on the LCD monitor by keeping the still image shooting button depressed when you capture the image.

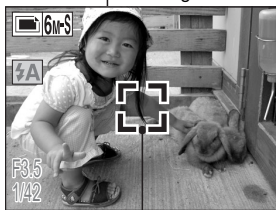
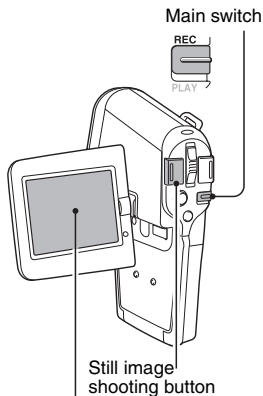

Target mark

CAPTURING IMAGES

HINT

What is the camera focusing on?

- A target mark  on the LCD monitor shows the area the camera is focusing on.
- The camera automatically determines the correct focus by measuring from 5 different focus points within the shooting area. If the target mark is at a position that is different from the point you wish to focus on, you can refocus, for example, by changing the shooting angle.
- The large target mark appears when the camera focuses on a wide area in the center of the screen.

The shutter speed and aperture are displayed

- When the camera focuses and the target mark appears, at the same time, the shutter speed and aperture settings are also displayed. You can use them as a reference when shooting.

If the camera shake icon appears...

- During still image shooting, if the shutter speed is slow and the possibility that the image may be blurred due to camera shake becomes high, the camera shake icon may appear on the LCD monitor. In this case, use a tripod to stabilize the camera when shooting, or set the flash operation mode to automatic (page 60).
- When shooting with the scene select function set to the fireworks  mode, the camera shake icon always appears, but this is normal.

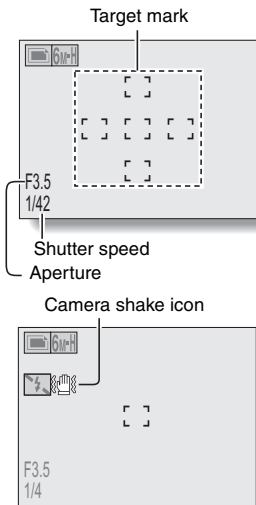

BASIC SHOOTING FUNCTIONS

Using the zoom

Your camera has two zoom functions: optical zoom and digital zoom. You can specify whether or not the digital zoom is enabled (page 118).

1 Point the camera lens at the subject.

2 Press the zoom switch to compose the desired image.

[T]: Zoom in on the subject.

[W]: Zoom out.

- When the zoom switch is pressed, the zoom bar appears on the LCD monitor.
- When the optical zoom factor is at maximum, zooming stops temporarily. When the zoom switch is pressed toward the [T] side again, the mode changes to the digital zoom mode and zooming continues.

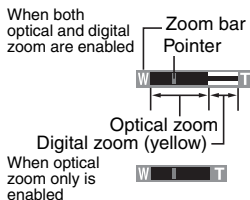
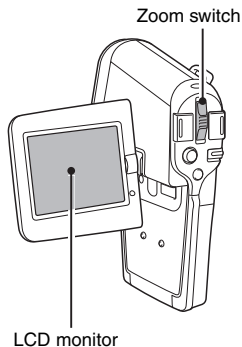

3 Take the picture.

For video clip recording, see page 34.

For still image shooting, see page 36.

Exposure correction

When capturing images, you can make the image lighter or darker.

- 1 Set the main switch to REC.**
 - To exit the Shooting Setting Screen, press the MENU button.
- 2 While the Shooting Screen is displayed, toggle the SET button to the right.**
 - The exposure correction bar appears.
- 3 Toggle the SET button to the left or right to adjust the exposure.**
 - The exposure setting numerical value is shown at the left end of the exposure bar.
 - The exposure can be set to a value from -1.8EV to $+1.8\text{EV}$.
- 4 Press the SET button or the MENU button.**
 - The exposure is set, and the exposure correction bar disappears.

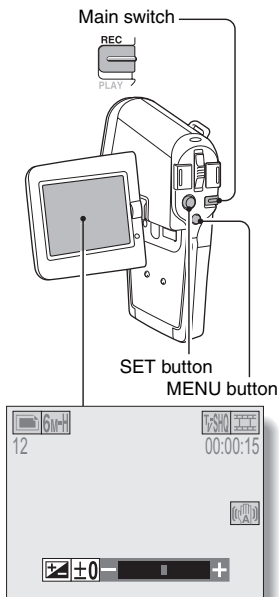

HINT

The exposure correction setting is canceled in the following cases:

- When the pointer is set to the center position.
- After a Playback or Option Screen is accessed.
- When the main switch is set to PLAY.
- After the power is turned off.

MAKE AN AUDIO RECORDING

Your camera can make audio recordings.

1 Turn on the camera (page 26), and set the main switch to REC.

2 Press the MENU button.

- The menu display appears.

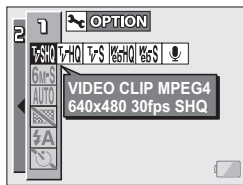

3 From the video clip mode menu, select the audio memo icon , and press the SET button.

- The recording mode is enabled.
- The menu display is canceled if the MENU button is pressed.

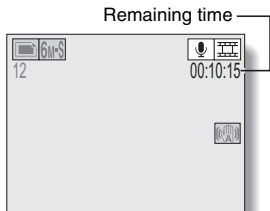

4 Press the video clip recording button.

- Audio recording begins. During recording,  appears in the LCD monitor. It is not necessary to continue pressing the video clip recording button while shooting.
- Take care not to cover the microphone with your fingers.
- When the remaining recording time becomes short, the time remaining is indicated in red.
- The maximum time for recording a continuous audio memo is about 13 hours.

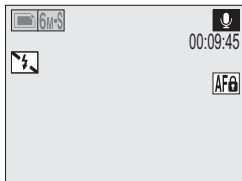



5 End the recording.

- Press the video clip recording button again to stop recording.

HINT

You can capture a still image during an audio recording

- Note, however, that if the resolution in the still image mode is set to  or , it automatically changes to  and the image is captured.

VIEWING IMAGES

1 Turn on the camera (page 26), and set the main switch to **PLAY**.

- An image is displayed on the LCD monitor.
- Video clips are indicated by a video clip pattern along the top and bottom of the screen.

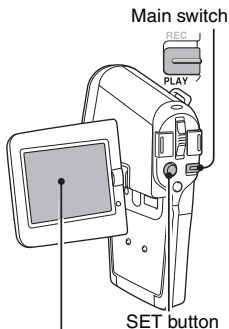

2 Select the image you wish to view.

To display the previous image, toggle the SET button to the left.

To display the next image, toggle the SET button to the right.

- For video clips and audio data, press the SET button to start playback.



9-image display playback

- 1 Turn on the camera (page 26), and set the main switch to **PLAY**.

- 2 Push the zoom switch toward the [W] ([]) side.

- The 9-image display appears.

- 3 Select the image to play back.

- Toggle the SET button up, down, left or right to move the orange frame to the desired image, and press the SET button. Instead of pressing the SET button, you can push the zoom switch toward the [T] ([]) side to show the image full screen.

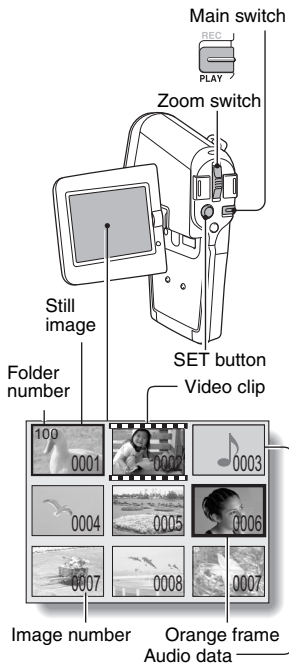

HINT

- The 9-image multi-playback display can also be accessed by selecting [] on the Playback Setting Screen.

VIEWING IMAGES

Magnifying (zooming in) the image

- 1** Display the image that you want to magnify.
- For a video clip, pause playback at the place you want to magnify.

- 2** Push the zoom switch toward the [T] ([🔍]) side.

- Magnification is enabled.
- The image is magnified, and the central portion of image is displayed.
- Toggle the SET button to view different parts of the magnified image.

To magnify:

Magnification increases each time the zoom switch is pushed toward the [T] ([🔍]) side.

To return to normal size:

Magnification decreases each time the zoom switch is pushed toward the [W] ([📐]) side.

- Press the SET button to return to the normal (100%) view.

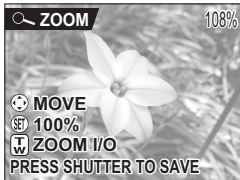

HINT

The magnified portion of the image can be saved as a separate image.

- Press the still image shooting button. The magnified portion is saved as a new still image.

Playing back a video clip

Follow these steps to play back a video clip.

To do this...		Do this
Normal forward playback		Press the SET button.
Stop playback		During playback, toggle the SET button down.
Pause		During playback, press the SET button or toggle the SET button up. During accelerated playback, toggle the SET button up.
To play back one image at a time (single-frame step)	During forward playback	After pausing playback, toggle the SET button to the right.
	During reverse playback	After pausing playback, toggle the SET button to the left.
Slow playback	During forward playback	After pausing playback, press and hold the SET button to the right.
	During reverse playback	After pausing playback, press and hold the SET button to the left.
To accelerate playback	Forward playback	During forward playback, toggle the SET button to the right. * The playback speed changes each time the SET button is toggled to the right, as follows: Normal playback → 2x → 5x → 10x → 15x Toggle the SET button to the left to resume normal playback speed.
	Reverse playback	During forward playback, toggle the SET button to the left. * The playback speed changes each time the SET button is toggled to the left, as follows: 15x ← 10x ← 5x Toggle the SET button to the right to resume normal playback speed.
Return to normal playback speed		Press the SET button.
Adjusting the volume		Louder: During playback, push the zoom switch toward the [T] side. Softer: During playback, push the zoom switch toward the [W] side.

VIEWING IMAGES

HINT

Display the video clip playback point

- During video clip playback, press the MENU button for at least 1 second to display a bar showing the current playback point in the video clip.
- Press the MENU button for about 1 second to cancel the bar.

CAUTION

If no audio is heard...

- The audio is not played back when the video clip is played back in the frame-by-frame, fast playback or reverse playback mode.

PLAYING BACK AUDIO DATA

Listen to your audio recordings.

1 Display the desired audio data.

2 Play back the recording.

Start forward playback:

Press the SET button.

Pause: During playback, press the SET button, or toggle the SET button up. During fast forward or fast reverse, toggle the SET button up.

Stop playback:

During playback, toggle the SET button down.

Fast forward/fast reverse:

- Fast forward/fast reverse playback is possible at 2x (forward only), 5x, 10x and 15x.
- Toggle the SET button to the left or right during playback to activate fast forward/fast reverse.
- The playback speed changes each time the SET button is toggled to the left or right.

Fast forward (toggle the SET button to the right)

2x → 5x → 10x → 15x

* Toggle the SET button to the left to return to normal speed.

Fast reverse (toggle the SET button to the left)

15x ← 10x ← 5x

* Toggle the SET button to the right to return to normal speed.

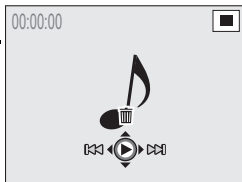

CAUTION

If no audio is heard...

- The audio is not played back when the audio file is played back in the fast playback or fast reverse mode.

DISPLAYING THE SHOOTING SETTING SCREENS

The Shooting Setting Screens are used to adjust your camera's shooting settings. The Shooting Setting Screens are organized into two displays: **PAGE 1** and **PAGE 2**. The **PAGE 1** settings (page 51) cover the basic shooting settings, and the **PAGE 2** settings (page 53) provide you with more detailed settings.

1 Turn on the camera (page 26).

2 Set the main switch to REC.

3 Press the MENU button.

- The Shooting Setting Screen appears.
- Pressing the MENU button again will cancel the Shooting Setting Screen.

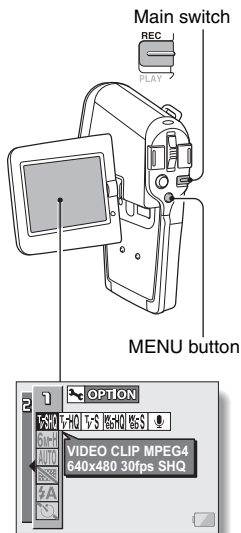

SWITCHING THE PAGE

Switch from PAGE 1 to PAGE 2, or vice versa, depending on how you wish to use your camera.

1 Display a Shooting Setting Screen (page 49).

2 Toggle the SET button to the left.

- The Shooting Setting Screen PAGE changes.
- Each time the SET button is toggled to the left, the PAGE changes.

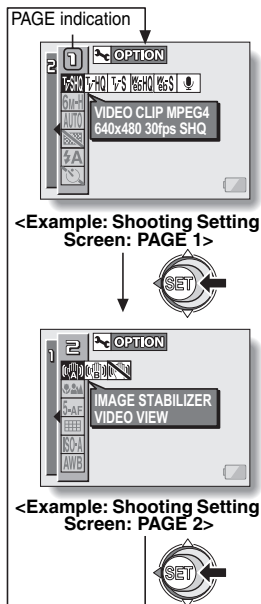



① **Video clip mode menu (page 55)**

: Record at 640 × 480 pixels, 30 frames per second, high bit rate

: Record at 640 × 480 pixels, 30 frames per second, standard bit rate

: Record at 320 × 240 pixels, 30 frames per second

: Record at 320 × 240 pixels, 15 frames per second

: Record at 176 × 144 pixels, 15 frames per second

: Make an audio recording

② **Still image mode menu (page 56)**

: Shoot at 2,816 × 2,112 resolution (6 million pixels), low compression

: Shoot at 3,680 × 2,760 resolution (10 million pixels)

: Shoot at 2,816 × 2,112 resolution (6 million pixels), standard compression

: Shoot at 1,536 × 2,048 resolution (3 million pixels, vertical position)

: Shoot at 1,600 × 1,200 resolution (2 million pixels)

: Shoot at 640 × 480 resolution (300,000 pixels)

③ **Scene select menu (page 57)**

: Full auto photography

: Sports photography

: Portrait photography

: Landscape photography

: Night view photography

: Fireworks photography

: Lamp photography

④ **Filter menu (page 59)**

: No filter

: Cosmetic filter selected

: Monochrome filter selected

: Sepia filter selected

⑤ **Flash menu (page 60)**

: Automatic flash mode

: Forced flash mode

: Flash off mode

⑥ **Self-timer menu (page 62)**

: Self-timer off

: Shooting begins 2 seconds after the still image shooting button or video clip recording button is pressed.

: Shooting begins 10 seconds after the still image shooting button or video clip recording button is pressed.

⑦ **Option icon (page 104)**

- Displays the Option Screen.

⑧ **PAGE display (page 50)**

⑨ **Help display (page 112)**

⑩ **Remaining battery power (page 132)**

- When you specify multiple functions that cannot be simultaneously enabled, the function which was last set becomes the active setting, and the other settings accordingly change automatically.

DISPLAYING THE SHOOTING SETTING SCREENS

PAGE 2

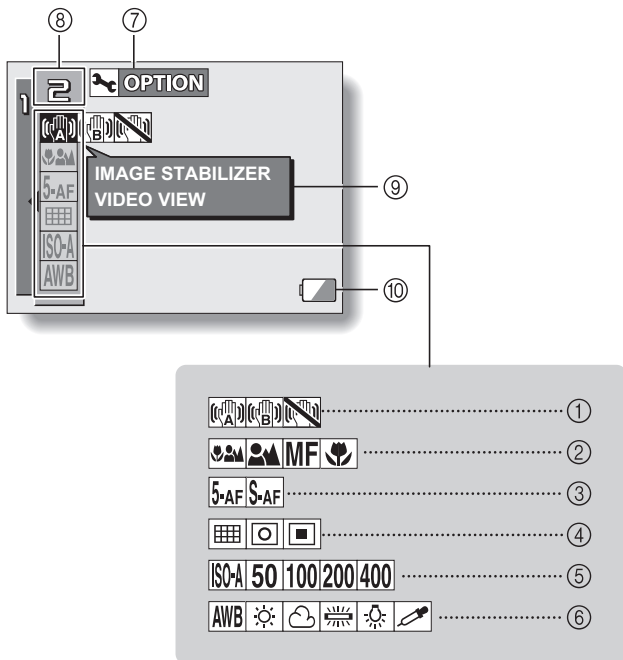

① **Image stabilizer menu (page 64)**

: Shoot using the video clip field of view display.

: Shoot using the still image field of view display.

: Image stabilizer function off

② **Focus range menu (page 66)**

: All ranges mode

: Normal mode

: Manual mode

: Super macro (close-up) mode

③ **Focus mode menu (page 68)**

: 5-point range finder focus setting

: Spot focus setting

④ **Light-measuring mode (EXP MEASURE) menu (page 69)**

: Multi-section light-measuring setting

: Center-weighted light-measuring setting

: Spot light-measuring setting

⑤ **ISO sensitivity menu (page 70)**

: Auto sensitivity (corresponds to ISO 50 to 200)

: Corresponds to ISO 50

: Corresponds to ISO 100

: Corresponds to ISO 200

: Corresponds to ISO 400

⑥ **White balance menu (page 71)**

: White balance is automatically adjusted depending on ambient lighting

: For photography in fair weather (sunny) conditions

: In overcast conditions

: Under fluorescent lighting

: Under incandescent lighting

: For setting the most accurate white balance

⑦ **Option icon (page 104)**

- Display the Option Screen.

⑧ **PAGE display (page 50)**

⑨ **Help display (page 112)**

⑩ **Remaining battery power (page 132)**

- When you specify multiple functions that cannot be simultaneously enabled, the function which was last set becomes the active setting, and the other settings accordingly change automatically.

IMAGE QUALITY



Still image mode (resolution) setting

By setting the still image resolution (pixels) to a higher setting, image detail is enhanced for a smoother, finer picture. However, the file size also becomes large and uses more memory. Select the resolution setting that suits your purpose.

1 Display the PAGE 1 Shooting Setting Screen (page 49).

2 Select the still image mode menu.

- 6M-H**: Shoot at 2,816 × 2,112 resolution (6 million pixels), low compression
- 10M**: Shoot at 3,680 × 2,760 resolution (10 million pixels)
- 6M-S**: Shoot at 2,816 × 2,112 resolution (6 million pixels), standard compression
- 3M-V**: Shoot at 1,536 × 2,048 resolution (3 million pixels, vertical position)
- 2M**: Shoot at 1,600 × 1,200 resolution (2 million pixels)
- 0.3M**: Shoot at 640 × 480 resolution (300,000 pixels)

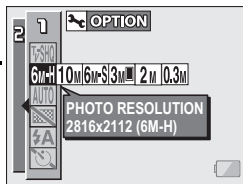

3 Select the desired icon from the still image resolution menu, and press the SET button.

- This completes the still image resolution setting.

SCENE SELECT

You can select from various preset settings (aperture, shutter speed, etc.) for specific shooting conditions.

1 Display the PAGE 1 Shooting Setting Screen (page 49).

2 Select the scene select menu.

AUTO: The camera automatically makes the optimum settings suitable for the surrounding conditions (full auto).

: Capture a split-second image of a fast-moving subject (sports mode).

: Enhance the 3D feeling of the subject by blurring the background (portrait mode).

: For beautiful shots of distant scenery (landscape mode).

: Photograph the subject while keeping the background night scenery (night view mode).

: For capturing fireworks at night (fireworks mode).

: Photograph in low-light conditions (lamp mode).

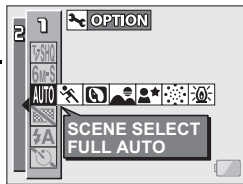

3 Select the desired icon from the scene select menu, and press the SET button.

- This completes the scene select function setting.



4 Take the picture.

For video clip recording, see page 34.

For still image shooting, see page 36.

To return to normal photography, select **AUTO** from the scene select menu, and press the SET button.

HINT





- When capturing images using the fireworks , lamp  or night view  setting, use a tripod or other method to stabilize the camera.
- A table showing the limitations for settings corresponding to scene select icons other than **AUTO** is on page 171.

FILTERS

The filter feature changes image characteristics such as color tones, to apply unique effects to the photographed image.

1 Display the PAGE 1 Shooting Setting Screen (page 49).

2 Select the filter menu.

- : No filter is used (none).
- : Skin tones are enhanced in close-up shots (cosmetic filter).
- : Snap black-and-white photos (monochrome filter).
- : Create a sepia-tone photo (sepia filter).

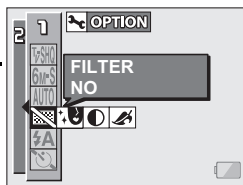

3 Select the desired icon from the filter menu, and press the SET button.

- This completes the filter setting.

4 Take the picture.

For video clip recording, see page 34.

For still image shooting, see page 36.

- To return to normal photography, select  from the filter menu, and press the SET button.

HINT

- A table showing the limitations for settings corresponding to filter icons other than  is on page 171.

FLASH SETTING

The flash is used not only for taking pictures where there is insufficient light, but also when the subject is in shade or in backlight conditions. Your camera has three modes of operation (automatic flash mode, forced flash mode, and flash off mode).

1 Display the PAGE 1 Shooting Setting Screen (page 49).

2 Select the flash menu.

- : The camera will detect the subject brightness and use the flash only when required. In a backlight situation, if only the center of the image is very dark, the flash will operate to compensate (auto flash).
- : The flash will operate with every image captured regardless of the conditions. Use this setting under backlight conditions, when the subject is in shade, under fluorescent lighting conditions, etc. (forced flash).
- : The flash will not operate even in dark situations. Use this setting when capturing an image in a location where flash photography is prohibited, or when shooting a night landscape scene (flash off).

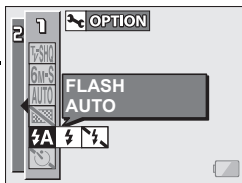

FLASH SETTING

3 Select the desired icon from the flash menu, and press the SET button.

- This completes the flash setting.

4 Take the picture.

For still image shooting, see page 36.

- To return to normal photography, select  from the flash menu, and press the SET button.



HINT

- You can change the flash setting by toggling the SET button to the left while the Shooting Setting Screen is displayed.

SELF-TIMER

- 1 Display the PAGE 1 Shooting Setting Screen (page 49).**

- 2 Select the self-timer menu.**

- : Turns off the self-timer function.
- : Turns on the self-timer function. The image is captured about 2 seconds after the still image shooting button or video clip recording button is pressed.
- : Turns on the self-timer function. The image is captured about 10 seconds after the still image shooting button or video clip recording button is pressed.

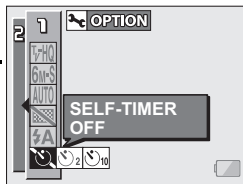

- 3 Select the desired icon from the self-timer menu, and press the SET button.**

- This completes the self-timer setting.



- 4 Take the picture.**

For video clip recording, see page 34.
For still image shooting, see page 36.

SELF-TIMER

HINT

To pause or cancel the self-timer function...

- If the video clip recording button or still image shooting button is pressed again before the shutter is released, the self-timer countdown temporarily stops. Press the video clip recording button or still image shooting button one more time to restart the self-timer.
- To cancel self-timer photography, select the  icon from the self-timer menu, and press the SET button.
- After the self-timer picture is snapped, the self-timer is automatically reset to off .

When is selected...

- When the still image shooting button or video clip recording button is pressed, the multi-indicator will blink for about 10 seconds, and then the image is captured. Also, 4 seconds before the shutter releases, the indication shown in the illustration appears on the LCD monitor.
- If you swivel the monitor unit towards the subject, the self-timer indication will be visible to the subject.

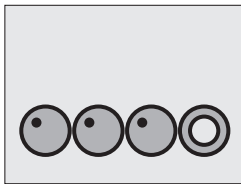



MOTION COMPENSATION (IMAGE STABILIZER)

Your camera can minimize a jittery picture by compensating for unintentional hand motion (video clips only).

1 Display the PAGE 2 Shooting Setting Screen (page 49).

2 Select the image stabilizer menu.

: Compensate for camera shake during video clip recording. The field of view does not change when the video clip recording button is pressed, so this setting is convenient when shooting mostly video clips (video clip field of view display).

: Compensate for camera shake during video clip recording. The field of view does not change when the still image recording button is pressed, so this setting is convenient when shooting mostly still images (still image field of view display).

: Disengages the motion compensation function (OFF).

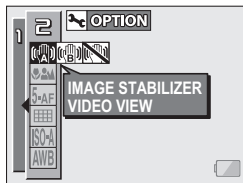

3 Select the desired icon from the image stabilizer menu, and press the SET button.

- This completes the image stabilizer setting.

HINT

If the motion compensation does not seem to be working...

- Due to the mechanical characteristics of this function, it may not be possible for the camera to compensate for violent motion.
- If the digital zoom (page 118) is being used, the large magnification factor may make it difficult for the motion compensation function to work correctly.
- When using a tripod or other means to stabilize the camera, please turn the motion compensation function off . If the motion compensation function is enabled when it is not actually needed, it may result in an image that appears unnatural.

MOTION COMPENSATION (IMAGE STABILIZER)

<Concerning the changing field of view when motion compensation is enabled>

- When the motion compensation is set to ON, the field of view during recording standby differs from the recordable field of view as shown below.
- When set to the motion compensation [] setting, the video clip recording range is as shown in the recording standby screen.

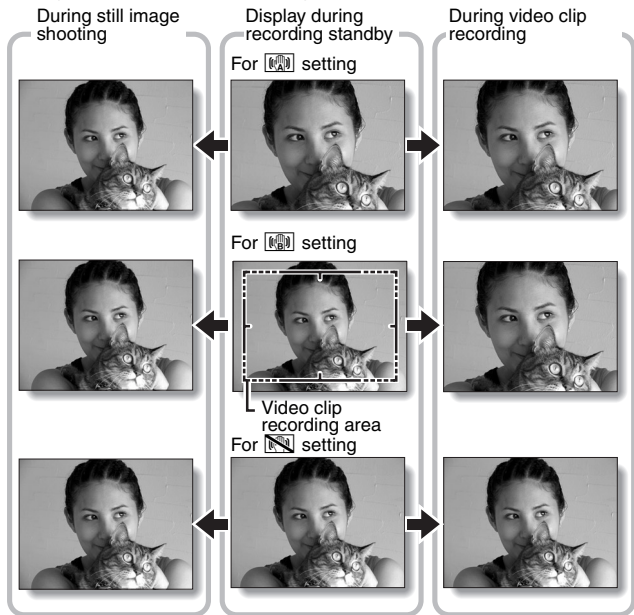







- When the still image shooting resolution is set to [0.3M] and the scene selection function to [AUTO], [], [] or [] (page 57), a still image captured during video clip recording will have the same field of view as the video clip.

FOCUS RANGE

1 Display the PAGE 2 Shooting Setting Screen (page 49).

2 Select the focus range menu.

- When shooting a subject at a medium to far distance, by setting the focus range to , you will find it both easier and faster to focus.
 - : Wide end: 10 cm (3.94 in.) to infinity
Tele end: 80 cm (31.50 in.) to infinity (total range mode)
 - : 80 cm (31.50 in.) to infinity (standard mode)
 - MF**: The focus can be manually set to any distance from 1 cm (0.39 in.) to 8 m (26.25 ft.), as well as to infinity (manual focus).
 - : 1 cm (0.39 in.) to 80 cm (31.50 in.) (super macro mode: wide end only)
 - When the focus range is set to ,  or **MF**, the corresponding indication appears on the LCD monitor.
-

3 Select the desired icon from the focus range menu, and press the SET button.

- This completes the focus range setting.
-

HINT

- From the Shooting Screen, you can quickly change the focus range setting by toggling the SET button down.
- When the focus range is set to super macro , the zoom is temporarily set to the wide end.

FOCUS RANGE

How to use the manual focus

- 1** Select the manual focus icon **MF** from the focus menu, and press the SET button.
- 2** Press the SET button.
 - The focus distance adjustment bar appears.
- 3** Toggle the SET button to the left or right to adjust the focus distance, and press the SET button.
 - The focus distance is set, and you are returned to the Shooting Screen.



HINT

About the focus range

- The focus distance indication shows the distance between the lens surface and the subject.
- In some cases there may be a slight variance between the distance (numerical figure) you set in the manual focus mode and the actual distance.

About zoom movement when using the manual focus

- If the focus distance is set to 70 cm (27.56 in.) or less, the zoom changes to the largest setting that is suitable for that focus distance.
- When the focus distance is set to 70 cm (27.56 in.) or less, the zoom will function only within the range at which the image is focused.

FOCUS AREA SETTING

You can choose from the following 2 types of autofocus (still image shooting only):

5-point range finder focus: The distance to the subject is detected by sampling from multiple areas of the entire shooting screen.

Spot focus: The camera focuses on the subject in the center of the LCD monitor.

1 Display the PAGE 2 Shooting Setting Screen (page 49).

2 Select the desired focus method from the focus mode menu, and press the SET button.

: 5-point range finder focus is selected.

: Spot focus is selected.

- When the spot focus setting is selected, the focus mark + appears in the center of the LCD monitor.

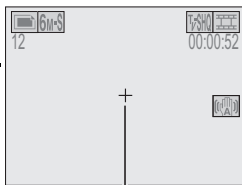

Focus mark

LIGHT-MEASURING MODE SETTING

You can select from 3 types of light-measuring modes.

Multi-section light-measuring:

The exposure is adjusted after sampling from multiple areas of the entire shooting screen.

Center-weighted light-measuring:



The exposure is adjusted after light is measured from the entire image, but with emphasis on the center area.

Spot light-measuring:

You can compose the picture and capture the image after first measuring the light only at the center spot of the LCD monitor.

1 Display the PAGE 2 Shooting Setting Screen (page 49).

2 Select the desired light-measuring mode from the light-measuring mode (EXP MEASURE) menu.

-  : Multi-section light-measuring
-  : Center-weighted light-measuring
-  : Spot light-measuring

3 Press the SET button.

- This completes the light-measuring mode setting.
- When spot light-measuring is selected, the light-measuring spot mark  appears in the center of the LCD monitor.

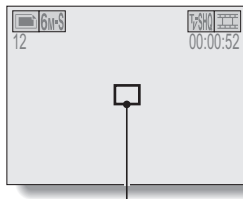

Light-measuring spot mark

ISO SENSITIVITY

With the initial settings, the ISO sensitivity is automatically set according to the brightness of the subject. However, the ISO sensitivity can be set to a fixed setting.

1 Display the PAGE 2 Shooting Setting Screen (page 49).

2 Select the ISO sensitivity menu.

- [ISO-A]**: Sets the ISO sensitivity automatically (equivalent to ISO 50 to 200 [video clip shooting mode: ISO 450 to 3,600]).
 - [50]**: Sets the sensitivity to ISO 50 equivalent (video clip shooting mode: ISO 450).
 - [100]**: Sets the sensitivity to ISO 100 equivalent (video clip shooting mode: ISO 900).
 - [200]**: Sets the sensitivity to ISO 200 equivalent (video clip shooting mode: ISO 1,800).
 - [400]**: Sets the sensitivity to ISO 400 equivalent (video clip shooting mode: ISO 3,600).
-

3 Select the desired icon from the ISO sensitivity menu, and press the SET button.

- This completes the ISO sensitivity setting.
-

HINT

- By setting a higher ISO sensitivity, you can set higher shutter speeds and capture images in darker locations, but noise in the captured images may increase.

WHITE BALANCE

This camera automatically adjusts the white balance under most lighting conditions. However, if you want to specify the lighting conditions or change the overall tone of the image, the white balance can be manually set.

1 Display the PAGE 2 Shooting Setting Screen (page 49).

2 Select the white balance menu.

: The camera will make the white balance adjustment automatically based on the natural and artificial light conditions.

: For shooting outside on a sunny day.



: For shooting outside on a cloudy day.

: For shooting inside under fluorescent lighting.







: For shooting inside under incandescent lighting.

: This setting is used for a more accurate white balance using the existing light source (one push). Please use it when the light source cannot be identified, for example.

Setting procedure

- ① Select the  icon and press the SET button.
 - The  icon moves to the left end of the line.
- ② Fill the entire screen with a plain white card (or piece of paper, etc.), and press the SET button.

3 Select the desired icon from the white balance menu, and press the SET button.

- Once the white balance setting is programmed for the  icon, it is retained even if another white balance setting (, , , , or ) is selected. If you changed to another setting, whenever you select the  icon and press the SET button, the previously programmed setting is recalled.

HINT

To cancel the white balance setting

- Perform step 1, select , and then press the SET button.

DISPLAYING THE PLAYBACK SETTING SCREENS

The Playback Setting Screens are used to adjust your camera's playback settings. The Playback Setting Screens are organized into two displays: **PAGE 1** and **PAGE 2**. The **PAGE 1** settings (page 75) cover the basic playback settings, and the **PAGE 2** settings (page 76) provide you with more detailed settings.

1 Turn on the camera (page 26).

2 Set the main switch to **PLAY**.

3 Press the **MENU** button.

- The Playback Setting Screen appears.
- Pressing the MENU button again will cancel the Playback Setting Screen.

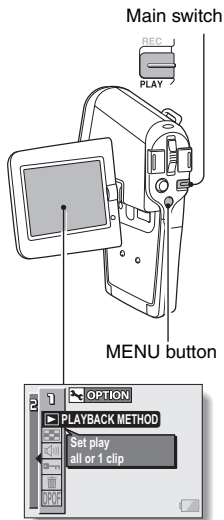

SWITCHING THE PAGE

Switch from PAGE 1 to PAGE 2, or vice versa.

1 Display a Playback Setting Screen (page 73).

2 Toggle the SET button to the left.

- The Playback Setting Screen changes to the other PAGE.
- Each time the SET button is toggled to the left, the PAGE changes.

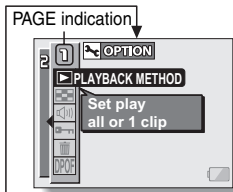

<Example: Playback Setting Screen: PAGE 1>

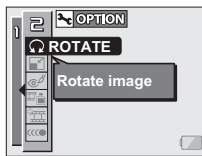

<Example: Playback Setting Screen: PAGE 2>



DISPLAYING THE PLAYBACK SETTING SCREENS

Overview of the Playback Setting Screens

PAGE 1

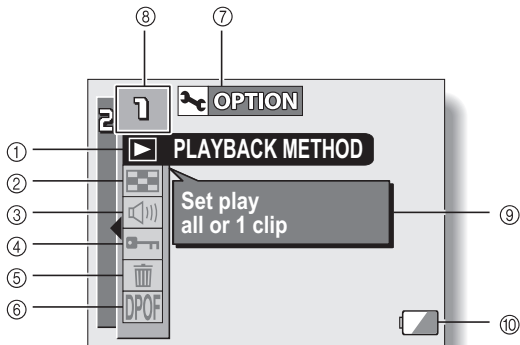

① **Playback method setting (page 77)**

- Select continuous playback or single-frame playback.

② **Multi-playback (page 44)**

- Display images in the 9-frame multi-display format.

③ **Playback volume control (page 78)**

- Adjust the playback volume for video clips and audio data.

④ **Data protect setting (page 79)**

- Protect data from accidental erasure.

⑤ **Erase (page 81)**

- Delete images from the card memory.

⑥ **Print settings (page 83)**

- Specify the print settings (DPOF settings).

⑦ **Option icon (page 104)**

- Display the Option Screen.

⑧ **PAGE display (page 74)**

⑨ **Help display (page 112)**

⑩ **Remaining battery power (page 132)**

PAGE 2

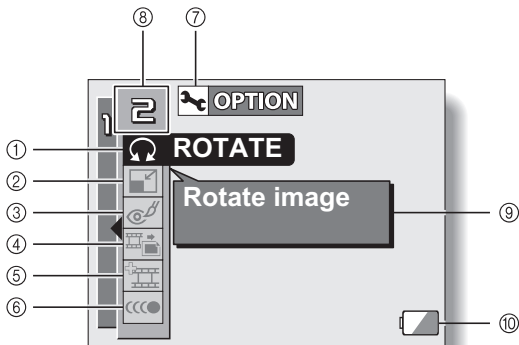

- ① **Rotate image (page 90)**
 - Rotate still images.
- ② **Resize (page 91)**
 - Reduce the resolution of a still image.
- ③ **Red-eye correction (page 92)**
 - Repair the red-eye effect to make eyes look more natural.
- ④ **Extract still image (page 94)**
 - Extract a still image from a video clip.
- ⑤ **Video clip edit (page 95)**
 - Edit video clips.
- ⑥ **Smooth playback (page 102)**
 - Smooth out the movement when playing back video clips.
- ⑦ **Option icon (page 104)**
 - Display the Option Screen.
- ⑧ **PAGE display (page 74)**
- ⑨ **Help display (page 112)**
- ⑩ **Remaining battery power (page 132)**

PLAYBACK MODE

Images can be viewed continuously (slideshow playback) or you can choose to show single images.

1 Display the PAGE 1 Playback Setting Screen (page 73).

2 Select the playback method icon

, and press the SET button.

- The Playback Mode Screen appears.

PLAY ALL: Play back images in slideshow fashion.

1 CLIP: Display only the selected image (page 43).

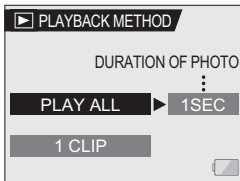

3 Select the desired playback mode.

<When **PLAY ALL** is selected>

- The screen to set the time that each image is displayed appears.
- ① Toggle the SET button to the right to select playback time.
 - ② Toggle the SET button up or down to specify the time that each image is shown.
 - ③ Press the SET button.

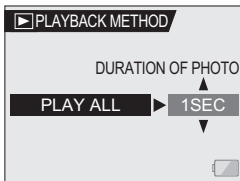

4 Press the SET button.

- The display time is set, and you are returned to the Playback Setting Screen.

IMAGE PROTECT

Prevent accidental erasure of image and audio data.

- 1** Display the data that you want to protect from accidental erasure, and display the PAGE 1 Playback Setting Screen (page 73).
-

- 2** Select the protect icon , and press the SET button.

- “LOCK?” appears.
- If the protect mode has already been enabled for the data, then “UNLOCK?” appears.

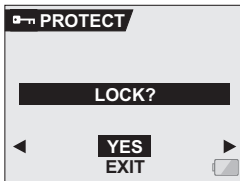

- 3** Toggle the SET button up or down to select “YES”, and press the SET button.

- The protect mode is set for the data.
- The protect mark  indicates that the data is locked.
- To return to the Playback Setting Screen, press the MENU button.



CAUTION

- Even if the protect mode is set for certain data files, they will be erased if the card is reformatted (page 128).

HINT**To select a different image in steps 2 and 3...**

- Toggle the SET button to the left or right.

To cancel the protect mode for an image...

- Display the desired data and repeat steps 1 to 3. The protect mark  will disappear and the protect mode is canceled.

ERASING DATA

You can erase data that is stored on the card if you no longer need it. You can erase the data one at a time, or all at once.

1 Display the PAGE 1 Playback Setting Screen (page 73).

2 Select the erase icon , and press the SET button.

- The Erase Mode Screen appears.

ONE ERASE: Erases one data at a time.

ERASE ALL: Erases all the data.

EXIT: Returns to the Playback Setting Screen.

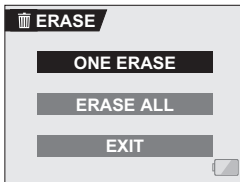

3 Toggle the SET button up or down to select the erase mode, and press the SET button.

- The Erase Confirmation Screen appears.

<ONE ERASE>

- Toggle the SET button to the left or right to select the data you wish to erase.

<ERASE ALL>

- Toggle the SET button to the left or right to confirm the data to erase.

4 Toggle the SET button up to select “YES”, and press the SET button. <ONE ERASE>

- The currently displayed image is deleted.
- To erase other data, select the data, and press the SET button.

<ERASE ALL>

- The Erase Confirmation Screen again appears. To erase the data, select “YES”, and press the SET button. When data erase is completed, “NO IMAGE” is shown.

CAUTION

- Data which is protected from accidental erase cannot be erased. To erase protected data, set the protect setting for the data to off (page 79), and then follow the data erase procedure.

HINT

- You can also access the One Erase Confirmation Screen from the Playback Screen by toggling the SET button up.

PRINT SETTINGS

In addition to using your printer to print out still images captured with your camera, as with conventional film, you can have prints made at shops offering digital print services. Moreover, this camera is DPOF-compatible, so you can use the camera to specify the number of prints, whether or not the date is displayed on the print, and also to specify an index print.

Display the Print Settings Screen

- 1 Display the PAGE 1 Playback Setting Screen (page 73).

- 2 Select the print settings icon , and press the SET button.

- The Print Setting Screen appears.

ALL IMAGES:

The specified print settings apply to all the still images on the card.

EACH IMAGE:

The print settings are specified for each individual image.

INDEX:

All the still images are printed as miniature images (thumbnail images), several images on one print.

ALL CLEAR:

Clear all the print settings. This cannot be selected if no print settings have been made for the image.

EXIT:

Return to the Still Image Playback Setting Screen.

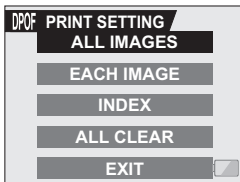

HINT

Printing a single frame from a video clip

- To print with a printer or have the digital print service shop print out a still image from a video clip, you must first save it (save frame) as a still image.

About the DPOF format

- DPOF (Digital Print Order Format) is a print order format. You can connect your camera to a DPOF-compatible printer to produce your prints. You can also set the print settings for the desired images, and then have the reserved images printed automatically (page 151).

About the finished prints

- Images that have been rotated will be printed in their original orientation.
- The quality of the print output will differ depending on the print service and printer used.

PRINT SETTINGS

Specifying date imprinting and print quantities

You can specify print settings for each individual image (**EACH IMAGE**), or apply the print settings to all the images on the card (**ALL IMAGES**).

1 Display the Print Setting Screen (page 83).

2 Select **EACH IMAGE** or **ALL IMAGES**.

ALL IMAGES:

The set print settings are applied to all the still images on the card.

EACH IMAGE:

The set print settings are applied only to the image currently displayed.

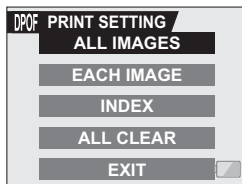

3 Press the **SET** button.

- The Date/Copies Print Screen appears.
- If "EACH IMAGE" was selected, toggle the SET button to the left or right to display the desired image to print.
- Under "SETTINGS" the settings that are currently active for the displayed image are shown. You can toggle the SET button to the left or right to confirm the print settings for each image.



4 Specify whether the date is displayed on the print, and the number of prints.

<Specifying dated prints>

- ① Toggle the SET button up or down to select "DATE".
- ② Press the SET button.
 - The Print Date Screen appears.
- ③ Toggle the SET button up or down to select the desired option.

YES:

Print the date.

NO:

Do not print the date.

- ④ Press the SET button.
 - You are returned to the Date/ Copies Print Screen.

<Specifying the number of prints>

- ① Toggle the SET button up or down to select "COPIES".
- ② Press the SET button.
 - The Print Number Screen appears.
- ③ Toggle the SET button up or down to specify the number of prints.
 - Toggle the SET button up or down until the desired number of prints is displayed.
- ④ Press the SET button.
 - You are returned to the Date/ Copies Print Screen.

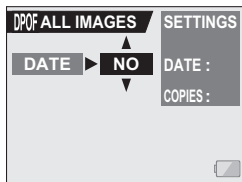

PRINT SETTINGS

- 5** Select **“ADD TO PRINT SETTING”** and press the **SET** button.
- The Confirm Print Settings Screen appears.
If the print settings are correct:
Select **“EXIT”**, and press the **SET** button.
If the print settings were changed:
Select **“MODIFY PRINT SETTING”**, and press the **SET** button.

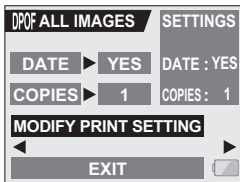

Index print

Printing out many small images on one sheet is called an **“index print”**. This is convenient for use as a list of the images you have captured.

-
- 1** Display the Print Setting Screen (page 83).
-
- 2** Select **“INDEX”**.

3 Press the SET button.

- The Index Print Screen appears.

YES:

Specify an index print copy.

EXIT:

Discontinue the setting procedure,
and return to the Print Setting
Screen.

4 Select “YES”, and press the SET button.

- This completes the setting for the index print. You are returned to the Print Setting Screen.

PRINT SETTINGS

Clearing all the print settings

Delete the print settings for all images.

1 Display the Print Setting Screen (page 83).

2 Select "ALL CLEAR".

3 Press the SET button.

- The Confirm All Clear Screen appears.

YES:

Clear the print settings for all images.

EXIT:

Cancel the clear procedure and return to the Print Setting Screen.

4 Select "YES", and press the SET button.

- All the print settings are cleared and you are returned to the Print Setting Screen.

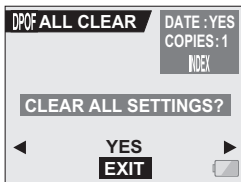

ROTATE IMAGE

Captured still images can be rotated to the correct orientation for viewing.

- 1** Display the still image you wish to rotate, and display the **PAGE 2 Playback Setting Screen (page 73)**.

- 2** Select the rotate icon , and press the **SET** button.
 - The Rotate Image Screen appears.

RIGHT: Rotates image clockwise 90 degrees.

LEFT: Rotates image counterclockwise 90 degrees.

EXIT: Return to the Playback Setting Screen.

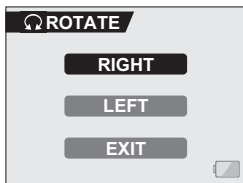

- 3** Select **“RIGHT”** or **“LEFT”**, and press the **SET** button.
 - Each time the SET button is pressed, the image is rotated another 90 degrees.

CHANGING IMAGE SIZE (RESIZE)

The size of a still image that has already been captured at a resolution of **2M** or more can be changed to 1,600 × 1,200 pixels or 640 × 480 pixels. The resized image is saved as a separate image.

1 Display the still image whose size you want to change, and display **PAGE 2** of the Playback Setting Screen (page 73).

2 Select the resize icon , and press the **SET** button.

- The Resize Screen appears.

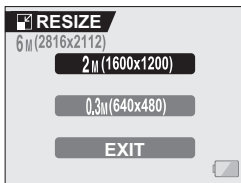

3 Toggle the **SET** button up or down to select the new image size.

2M (1600 × 1200): The saved image will be 1,600 × 1,200 pixels.

0.3M (640 × 480): The saved image will be 640 × 480 pixels.

EXIT: Return to the Playback Setting Screen.

4 Press the **SET** button.

- Resizing begins.

HINT

Why can't the image be resized?

- An image can be resized only to a smaller (or the same) size, not to a larger size.

RED-EYE CORRECTION

If you photograph your subjects at night using the flash, they may appear in the image with glowing red eyes (red-eye phenomenon). Now you can amend the image so that the subjects' eyes appear more natural (red-eye correction).

1 Display the image to be modified, and display the **PAGE 2 Playback Setting Screen** (page 73).

2 Select the red-eye correction icon , and press the **SET** button.

- The Red-Eye Correction Screen appears.

YES: Proceed with the red-eye correction.

EXIT: Return to the Playback Setting Screen.



3 Select “**YES**” and press the **SET** button.

- Red-eye correction is executed.
- During the red-eye correction process, “**PROCESSING**” is shown on the screen.
- When the correction is completed, the modified image is shown. Check the image to see if the post-processing result is satisfactory.

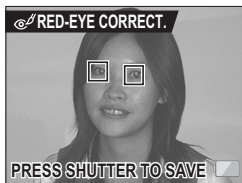

RED-EYE CORRECTION

4 Press the still image shooting button.

- A screen appears for you to specify whether or not to keep the original image.

YES: The corrected image is saved as a separate image, and the original image is preserved.

NO: The corrected image replaces the original image.

EXIT: The corrections are canceled, and you are returned to the Playback Setting Screen.



5 Select the desired method to save the corrected image, and press the SET button.

- The corrected image is saved, and you are returned to the Red-eye Correction Screen.

HINT

If the “RED-EYE CORRECTION NOT SUCCESSFUL” message appears...

- The camera was not able to successfully correct the red-eye phenomenon.
- The red-eye correction function works to automatically edit the red-eye phenomenon that the camera detects in captured images. In some cases, the camera may fail to correctly detect the red-eye phenomenon, or it may incorrectly identify the red-eye phenomenon where it does not exist.

Concerning the date and time information for the saved image

- When an image is corrected and saved, the recorded date and time of capture (Exif information) remains unchanged from the original image. However, the file date shown on the computer changes to the date and time the image was revised.

EXTRACTING A STILL IMAGE FROM A VIDEO CLIP

You can select one image (scene) from a video clip, copy it, and save it as a still image (the original data remains unchanged).

1 Play back a video clip, and pause at the point you wish to copy and save.

2 Display the **PAGE 2 Playback Setting Screen** (page 73).

3 Select the extract still icon , and press the **SET** button.

- The screen to extract an image appears.

YES: The image is copied and saved as a still image (the original data is left unchanged).

EXIT: You are returned to the Playback Setting Screen.



4 Select **“YES”** and press the **SET** button.

- The image is extracted.

HINT

To select a different image (frame) in step 3...

- Toggle the SET button to the left or right.

EDITING VIDEO CLIPS

You can delete (“cut”) the first part or the last part of a video clip. You can choose anywhere in the video clip as the cutting point. You can also join two video clips together and save them as one separate clip (“joining”).

CAUTION

Warning concerning the battery pack remaining charge

- During the editing of lengthy video clips, the time to process the large amount of data can become quite long. To avoid problems caused by the battery pack becoming depleted in the middle of video clip editing, before starting to edit be sure that a sufficiently charged battery pack is installed in the camera, or connect the AC adaptor.
- It is recommended that a computer be used to edit long video clips.

Procedure to save part of a video clip as a separate clip

Play the video clip, and pause playback at the point you want to cut.



Select whether to delete the portion before the cut point or after the cut point.



Delete the specified portion.

- The specified portion is deleted.



- The original video clip is not affected. ..



(You can also choose to erase the original video clip when the new clip is saved.)

Procedure to join two video clips

Display the video clip that will come first.



Select the video clip that you wish to append (join).



Join the video clips. (Press the SET button.)

- The two video clips are saved together as a separate video clip. ..



- The original video clips are not affected. (You can also choose to erase the original video clips when the new clip is saved.)



CAUTION

Caution when editing video clips

- When editing video clips, do not move the main switch. If you move the main switch while editing video clips, not only will the editing not be properly completed, but the original video clip may also be erased.
- By repeating the clipping and joining procedures, you can create exactly the video clip you like. Note, however, that as the number or size of the video clips increases, the card memory may become full, making it impossible to edit the video clips. In this case, you will need to free some of the memory on the card either by deleting data that are no longer necessary (page 81), or by performing the procedure to erase the original video clip(s) (pages 99, 101).

EDITING VIDEO CLIPS

Deleting part of a video clip

1 Display the video clip you wish to edit.

2 Display the scene you wish to delete.

- In step 5 you will specify whether you wish to delete the portion from the beginning of the video clip up to the selected scene, or the portion from the selected scene to the end of the video clip.

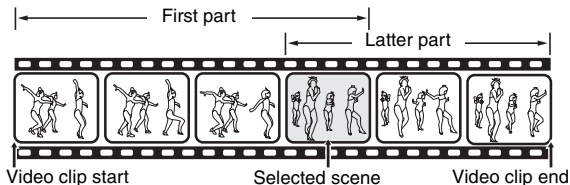

- To select the desired scene quickly, you can use a combination of the fast-forward (or reverse) playback, pause, and image-by-image playback functions (page 46).
- The actual cut point may be slightly before or after the displayed scene.

3 Display the PAGE 2 Playback Setting Screen (page 73).

-
- 4** Select the edit video icon , and press the SET button.
- The Edit Video Screen appears.

-
- 5** Toggle the SET button up or down to select the portion you wish to delete.

DELETE 1ST PART:

Delete the first part of the video clip.

DELETE 2ND PART:

Delete the latter part of the video clip.

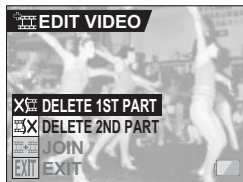

-
- 6** Press the SET button.

- A screen appears for you to confirm whether or not you want to keep the original video clip.



EDITING VIDEO CLIPS

7 Select whether you want the original video clip to be erased when clipping is executed.

YES:

The original video clip is saved.

NO:

The original video clip is not saved.

8 Press the SET button.

- Editing starts.
- If "YES" was selected, the edited video clip is saved as a new video clip.
- If "NO" was selected, the edited video clip is saved as a new video clip, and the original video clip is erased.
- When editing ends, you are returned to the Playback Setting Screen.

HINT

- If the original video clip is protected, even if you select "NO" in steps 7 and 8 and press the SET button, the original video clip will not be erased. If you want it to be erased, you will need to first remove the protection.

Joining two video clips

CAUTION

- Video clips that were photographed in different modes cannot be joined.

1 Display the first video clip.

2 Display the PAGE 2 Playback Setting Screen (page 73).

3 Select the edit video icon , and press the SET button.

- The Edit Video Screen appears.

4 Select the join icon .

EDITING VIDEO CLIPS

- 5** Press the **SET** button.
- The 9-image playback display for video clips appears.

- 6** Toggle the **SET** button to move the orange frame to the video clip that you wish to join.

- 7** Press the **SET** button.

- 8** Select whether you want the original video clip to be erased when clipping is executed.
- YES:**
The original video clips are kept.
- NO:**
The original video clips are not kept.

- 9** Press the **SET** button.
- Editing starts.
 - The two video clips are saved together as a separate video clip.
 - If “NO” was selected in step **8**, the original video clips are erased when the joined video clip is saved.
 - When editing ends, you are returned to the Playback Setting Screen.

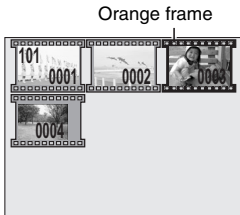

<Confirmation screen for saving the original video clip>

HINT

- If the original video clip is protected, even if you select “NO” in step **8** and press the **SET** button, the original video clip will not be erased. If you want it to be erased, you will need to first remove the protection.

SMOOTH PLAYBACK

Suppress the video flicker that occurs, for example, when playing back video clips that were recorded with camera moving fast.

1 Display the **PAGE 2 Playback Setting Screen** (page 73).

2 Select the smooth playback  icon, and press the **SET** button.

- The Smooth Playback Screen appears.

ON:

Activate smooth playback

OFF:

Deactivate smooth playback



3 Select **“ON”**, and press the **SET** button.

- This completes the smooth playback setting.
-

HINT

- Depending on the recording conditions, the smooth playback effect may be insignificant in some cases.

DISPLAYING IMAGE PROPERTIES (INFORMATION SCREEN)

On the Information Screen you can check what the settings were when an image was captured.

1 Display the desired image.

2 Press the MENU button for about 1 second.

- The Information Screen appears.
- If the MENU button is pressed again, the Information Screen is canceled.

- ① Video clip mode settings
- ② Image or sound number
- ③ Protect setting
- ④ File size
- ⑤ Shooting or recording time
- ⑥ Remaining battery charge
- ⑦ Date and time of image
- ⑧ Still image resolution settings

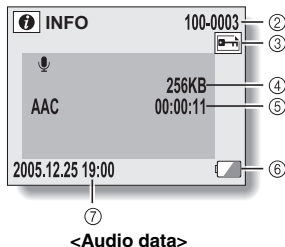
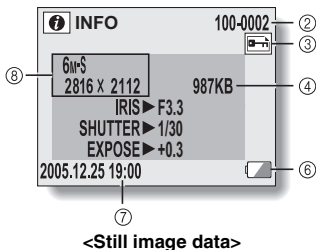
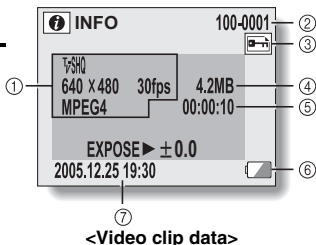

DISPLAYING THE OPTION SCREEN

The Option Screen is used to adjust various camera settings.

- 1 Turn on the camera, and press the MENU button.**
 - The Shooting or Playback Setting Screen appears.
-

- 2 Toggle the SET button up or down to select the PAGE indication.**
-

- 3 Toggle the SET button to the right, and select the option icon.**
 - The Option Screen appears.
 - The Option Screen is canceled if the MENU button is pressed.
-

- 4 Toggle the SET button down.**
 - The menu appears.

DISPLAYING THE OPTION SCREEN

Overview of the Option Screen

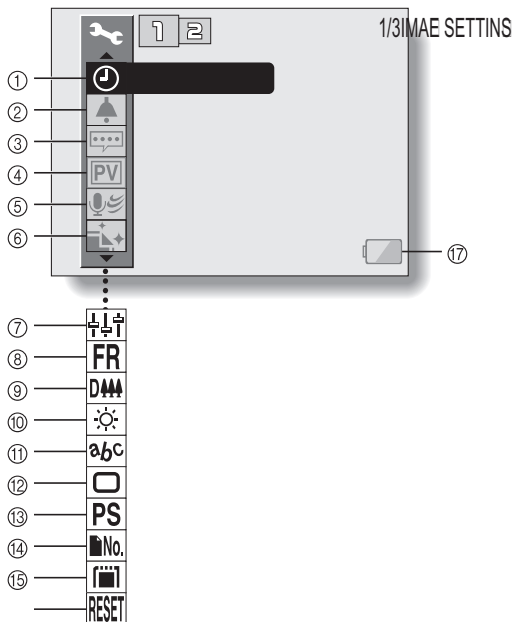

- ① **Date and time setting (page 107)**
 - Set the camera's internal clock.
- ② **Operation beep setting (page 110)**
 - Select the operation sounds that are produced when the camera's buttons are pressed, and adjust the operation sound volume.
- ③ **Help display setting (page 112)**
 - Turn the help display on or off.
- ④ **Post-view (page 113)**
 - Specify how long the captured image is displayed on the LCD monitor after the still image shooting button is pressed.
- ⑤ **Wind noise reduction setting (page 114)**
 - Set the wind noise reduction function on or off.
- ⑥ **Noise-reduction menu (page 115)**
 - Set the noise-reduction function on or off.
- ⑦ **Image quality adjustment (page 115)**
 - Adjust the image quality during shooting.
- ⑧ **Flicker-reduction menu (page 117)**
 - Set the flicker-reduction function on or off.
- ⑨ **Digital zoom setting (page 118)**
 - Enable or disable the digital zoom.
- ⑩ **Monitor brightness (page 119)**
 - Adjust the brightness of the LCD monitor.
- ⑪ **Screen language (page 120)**
 - Select the language in which the LCD monitor messages are displayed.
- ⑫ **TV output settings (page 121)**
 - Select the type of video signal that is output from the camera's USB/AV terminal.
- ⑬ **Power save function (page 123)**
- ⑭ **File number reset (page 125)**
 - Select the file number reset function.
- ⑮ **Card format (page 128)**
 - Use the camera to format the memory card.
- ⑯ **Reset camera settings (page 130)**
 - Reset the camera to the factory-preset settings.
- ⑰ **Remaining battery power (page 132)**

* Icons ⑦ through ⑰ are displayed when you toggle the SET button up or down to scroll.

DATE AND TIME SETTING

The camera will record the date and time an image or audio recording is taken so that you can display them during playback. Therefore, before capturing images, make sure the correct date and time are set.

Example: To set the clock to 7:30 p.m. on December 24, 2005

1 Display the Option Screen (page 104).

2 Select the clock set icon , and press the SET button.

- The Clock Set Screen appears.
- The current date and time settings are shown.
- Follow the procedures below to enable or disable the date display during playback, to set the display format for the date, and to set the date and time.
- To return to the Option Screen, press the MENU button, or select "EXIT" and press the SET button.

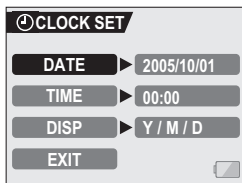

3 Set the date.

- ① Select "DATE".
- ② Press the SET button.
 - The Set Date Screen appears.
- ③ Set the date to "2005/12/24".
 - The date is set in the following order: Set the year → Set the month → Set the day.
 - Toggle the SET button left or right to select year, month or day. Toggle the SET button up or down to increase or decrease the number.
- ④ Press the SET button.

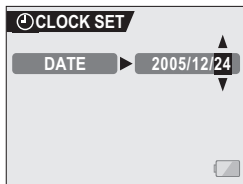

4 Set the clock.

- ① Select "TIME".
- ② Press the SET button.
 - The Set Time Screen appears.
- ③ Set the time to "19:30".
 - The time is set in the following order: Set the hour → Set the minute.
 - A 24-hour clock is used for the time display.
- ④ Press the SET button.

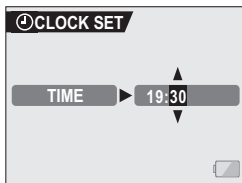

5 Set the order in which the date is displayed during playback.

- ① Select "DISP".
- ② Press the SET button.
 - The Set Date Format Screen appears.
- ③ Toggle the SET button up or down.
 - Toggle the SET button up to change the displayed date order as follows:

→ year/month/day → month/day/year → day/month/year → DISP OFF (no display)

Toggle the SET button down to change it in the reverse order.

- If "DISP OFF" is selected, the date the image was captured is not shown during playback.
- ④ Press the SET button.

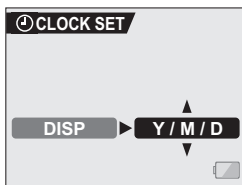

DATE AND TIME SETTING

6 Select "EXIT", and press the SET button.

- The date and time setting is completed, and you are returned to the Option Screen.
- To return to the Shooting Screen, press the MENU button.

HINT

- Under normal conditions, while the battery pack is being replaced, an internal battery will maintain the date and time settings. However, there is a small chance the settings may be lost. (The backup will last for about 7 days.) It is recommended to check that the date and time settings are still correct after replacing the battery pack and before shooting or recording of any type (follow steps **1** and **2**).

To correct the date and time settings

- After steps **1** and **2**, select the line of the setting that you want to change, press the SET button, and follow the steps in the respective paragraphs above to change the setting.

OPERATION SOUNDS

Use this menu to set the confirming audio signals when the camera is turned on/off or when the operation buttons (still image shooting button, SET button, MENU button, etc.) are pressed, to adjust the operation sound volume, and to enable/disable the audio guide.

1 Display the Option Screen (page 104).

2 Select the operation beep icon , and press the SET button.

- The Operation Beep Setting Screen appears.
- The current settings are shown on the screen.
- If "ALL OFF" is selected and the SET button pressed, all the operation sounds are muted.
- If "EXIT" is selected and the SET button pressed, you are returned to the Option Screen.

TURN ON/OFF:

Mute or enable the sound that is produced when the power is turned on or off.

SHUTTER:

Select the sound that is produced when the still image shooting button is pressed, or when a photo is taken using the self-timer.

KEY SW:

Select the sound that is produced when the SET button, MENU button, etc. are pressed.

AUDIO GUIDE:

Mute or enable the camera's audio help guide.

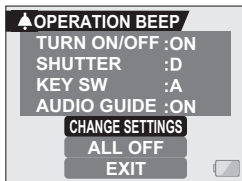

OPERATION SOUNDS

3 Select "CHANGE SETTINGS", and press the SET button.

- The screen to change the settings appears.

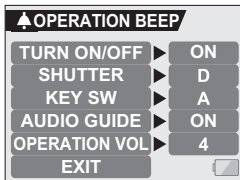

4 Toggle the SET button up or down to select the desired setting, and press the SET button.

- The screen to select operation sounds appears.

<If "TURN ON/OFF" or "AUDIO GUIDE" is selected>

- The respective screen to enable or disable the sound appears.
- Toggle the SET button up or down to select the desired setting, and press the SET button.

ON: Activates the sound.

OFF: Deactivates the sound.

<If "SHUTTER" or "KEY SW" is selected>

- The screen to select the operation sounds appears.
- Select from 8 different sounds (A to H).
- You can press the still image shooting button to preview the selected operation sound.
- If "OFF" is selected, no sound is produced.
- Toggle the SET button up or down to select the desired setting, and press the SET button.

<If OPERATION VOL was selected>

- The screen to select the volume for the operation sounds appears.
- You can select an operation sound volume from 1 (minimum) to 7 (maximum).
- Toggle the SET button up or down to select the volume, and press the SET button.

5 Select "EXIT", and press the SET button.

- The operation sound settings are completed.

HINT

- If you keep the MENU button pressed and turn on the power, the screen to turn the operation sounds ON/OFF appears at once. You may find this a convenient procedure to disable the operation sounds in places you do not want them to be audible.

HELP DISPLAY

You can set whether or not the help messages shown on the LCD monitor.

- 1** Display the Option Screen (page 104).
-

- 2** Select the help display icon  and press the SET button.

- The Help Setting Screen appears.
ON:
The HELP messages are enabled.
- **OFF:**
The HELP messages are disabled.

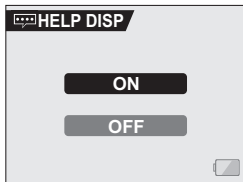

- 3** Toggle the SET button up or down to select the desired setting, and press the SET button.

- This completes the help display setting.

POST-VIEW SETTING

The duration that the captured image appears on the LCD monitor (within 1 second) after the still image shooting button is pressed.

Display the Option Screen (page 104).

Select the post-view icon **[PV]**, and press the **SET** button.

- The Post-view Screen appears.

1 SEC:

The post-view image is displayed for 1 second.

2 SEC:

The post-view image is displayed

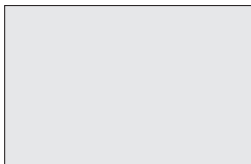

3

Select the **[PV]** icon and press the **SET** button.

- This completes the post-view setting.

WIND NOISE REDUCTION

This feature reduces the ambient sound of the wind when you are recording a video clip or making an audio recording in a strong wind environment. Set the function to on or off.

1 Display the Option Screen (page 104).

2 Select the wind noise reduction icon , and press the SET button.

- The Wind Noise Reduction Screen appears.

ON:

The wind noise reduction function is turned on.

OFF:

The wind noise reduction function is turned off.

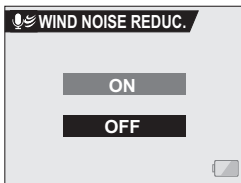

3 Select the desired setting, and press the SET button.

- This completes the wind noise reduction setting.

HINT

- For normal shooting, set the wind noise reduction to “OFF”. If the function is enabled when there is no wind, the audio during shooting and recording sounds unnatural.

NOISE-REDUCTION FUNCTION

Use this setting to minimize noise in still images and produce a clear image.

1 Display the Option Screen (page 104).

2 Select the noise-reduction icon , and press the SET button.

- The Noise Reduction Screen appears.

ON: The noise-reduction function is enabled.

OFF: The noise-reduction function is disabled.

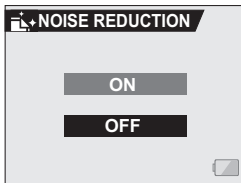

3 Select the desired setting, and press the SET button.

- This completes the noise-reduction setting.

HINT

- The noise-reduction function operates when the shutter speed is slower than 1/4 second.
- Compared to normal shooting, the image processing time after shooting is slightly longer.

ADJUST THE IMAGE QUALITY

The camera can adjust the image quality as the image is captured.

1 Display the Option Screen (page 104).

2 Select the image quality icon , and press the SET button.

- The Image Settings Screen appears.

NORMAL: Shoot with image quality at normal.

VIVID: Color saturation is increased.

SOFT: The sharpness is subdued for a softer image.

SOFT VIVID: The sharpness is softened and color saturation is increased.

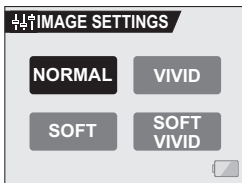

3 Select the desired setting, and press the SET button.

- This completes the image quality setting.

FLICKER-REDUCTION

The flicker-reduction setting reduces the flicker that results when filming video clips under fluorescent lights and the like where the background lighting pulsates at the frequency of the power supply. The flicker-reduction setting is set to a frequency of 50 Hz.

1 Display the Option Screen (page 104).

2 Select the flicker-reduction icon **[FR]**, and press the **SET** button.

- The Flicker Reduction Screen appears.

ON: Turns on the flicker-reduction setting.

OFF: Turns off the flicker-reduction setting.



3 Select the **[FR]** icon from the flicker-reduction menu, and press the **SET** button.

- This completes the flicker-reduction setting.

HINT

- If the flicker-reduction setting is used outdoors on a very bright day, a halation effect, which produces diffused rings of light around bright light areas, may occur.

DIGITAL ZOOM SETTING

This setting allows you to specify whether or not the digital zoom is enabled during zoom shooting.

1 Display the Option Screen (page 104).

- 2** Select the digital zoom icon , and press the **SET** button.
- The Digital Zoom Screen appears.
ON: Digital zoom can be used.
OFF: Digital zoom cannot be used.
-

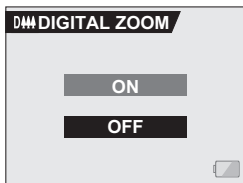

- 3** Select the desired setting, and press the **SET** button.
- This completes the digital zoom setting.

LCD MONITOR BRIGHTNESS

Adjust the brightness of the camera's LCD monitor display. Use this adjustment when the monitor image is difficult to view because of ambient lighting.

1 Display the Option Screen (page 104).

2 Select the LCD brightness icon , and press the SET button.

- The brightness control display appears.

Turn the LCD backlight ON/OFF:

Toggle the SET button down.

Adjust the brightness:

Toggle the SET button left or right.

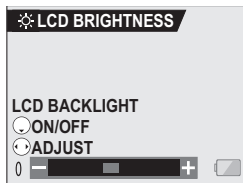

3 Press the SET button.

- The LCD monitor brightness is set.
-

HINT

- From the Shooting Screen, you can quickly access the screen for adjusting the brightness of the LCD monitor by pressing the MENU button for at least 1 second.

SCREEN LANGUAGE

You can set the LCD monitor of your camera to display the messages in any one of several languages.

1 Display the Option Screen (page 104).

2 Select the language icon , and press the SET button.

- The Language Screen appears.

DEUTSCH:	German
ENGLISH:	English
ESPAÑOL:	Spanish
FRANCAIS:	French
ITALIANO:	Italian
NEDERLANDS:	Dutch
РУССКИЙ:	Russian
日本語:	Japanese
한국어:	Korean
中文(繁):	Chinese (traditional)
中文(简):	Chinese (simplified)

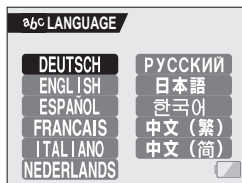

3 Select the desired language, and press the SET button.

- The selected display language is set.

TV OUTPUT SETTING

Specify the type of image signal that is output from your camera's USB/AV terminal.

1 Display the Option Screen (page 104).

2 Select the TV output settings icon , and press the SET button.

- The TV Output Setting Screen appears.

TV SYSTEM:

Set the type of TV signal.

VIDEO OUTPUT:

Set the type of video signal.

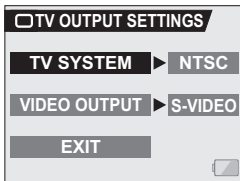

3 Select the desired setting, and press the SET button.

- The screen to change the parameter for the selected setting appears.

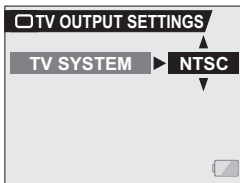

<Example: TV SYSTEM>

4 Toggle the SET button up or down to select the desired parameter.
<If “TV SYSTEM” is selected>

NTSC:

Outputs NTSC video signals.

PAL:

Outputs PAL video signals.

<If “VIDEO OUTPUT” is selected>

S-VIDEO:

Outputs S-VIDEO signals.

VIDEO:

Outputs standard video signals.

5 Press the SET button.

6 Select “EXIT”, and press the SET button.

- The selected TV output setting is set.
-

HINT

When connecting to a standard video input terminal (composite video)

- On your camera's Option Screen, set the “VIDEO OUTPUT” setting to “VIDEO”.
- Do not connect to an S-VIDEO input terminal, as doing so may cause the TV to automatically switch to the S-VIDEO input mode, and no image will appear on the TV monitor.

When connecting to an S-VIDEO input terminal

- On your camera's Option Screen, set the “VIDEO OUTPUT” setting to “S-VIDEO”.
- Do not connect to a VIDEO INPUT terminal, as doing so may cause the TV to automatically switch to the video input mode, and no image will appear on the TV monitor.

If no image appears on the TV...

- If the TV system setting or video output setting is not correct for the connected equipment, no image will appear on the TV.

When set to “PAL” and connected to a TV using the included S-AV interface cable (page 138)

Shooting: Images are displayed on the LCD monitor only and do not appear on the TV.

Playback: Images are displayed on the TV only and do not appear on the LCD monitor.

POWER SAVE FUNCTION

Your camera has a “power save” function whereby the power automatically turns off after a specified period of inactivity. The power save function works to conserve the battery pack power when the camera is not being used, or to prevent the battery pack from dying if the camera has accidentally been left on. You can specify the elapsed time (standby time) before the power save function is activated.

1 Display the Option Screen (page 104).

2 Select the power save icon [PS], and press the SET button.

- The Power Save Setting Screen appears.

BATT/CAM:

Set the standby time for the shooting modes when the battery pack is used.

BATT/PB:

Set the standby time for the playback modes when the battery pack is used.

EXT.PWR/CAM.PB:

Set the standby time for the shooting and playback modes when using an AC power source.

EXIT:

Return to the Option Screen.

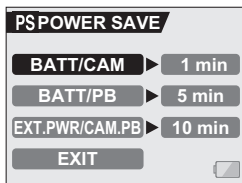

3 Select the desired option, and press the SET button.

- The Set Standby Time Screen appears.

4 Toggle the SET button up or down to set the standby time.

Up:

Increases the standby time.

Down:

Decreases the standby time.

5 Press the SET button.

- The standby time is set, and you are returned to the Power Save Setting Screen.

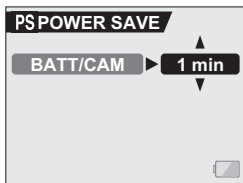

<Example: When "BATT/CAM" is selected>

FILE NO. RESET FUNCTION

If a newly formatted card is used, the file name (image number) of the captured image automatically begins from 0001. If the card is subsequently reformatted, or if a different reformatted card is used, the file names again begin from 0001. This is because the file number reset function is set to "ON", and consequently it results in more than one card containing images with the same numbers. By setting the file number reset function to "OFF", even if the card is reformatted or the card is replaced with another card, the consecutive numbering of file names continues from the last number recorded by the camera.

<File number reset function "ON">

	File name (image number)
Card A	0001, 0002 0012, 0013

:
Replace card

▼

Card B	0001, 0002 0012, 0013
--------	-----------------------------

<File number reset function "OFF">

	File name (image number)
Card A	0001, 0002 0012, 0013

:
Replace card

▼

Card B	0014, 0015 0025, 0026
--------	-----------------------------

- If Card B already has image data in it when it replaces Card A, file names are assigned as follows.

When the highest file number on Card B (before replacing) is lower than the highest file number on Card A: the file number of the next recorded image continues from last file number recorded on Card A.



When the highest file number on Card B (before replacing) is higher than the highest file number on Card A: the file number of the next recorded image continues from last file number recorded on Card B.

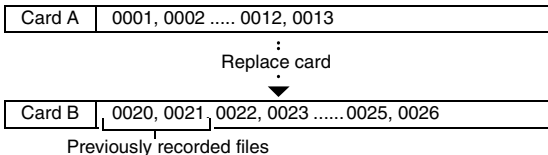

FILE NO. RESET FUNCTION

1 Display the Option Screen (page 104).

2 Select the file number reset icon .

3 Press the SET button.

- The File Number Reset Screen appears.

ON:

The file number reset function is "ON".

OFF:

The file number reset function is "OFF".

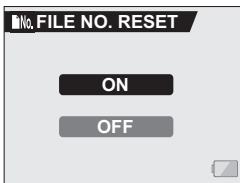

4 Select "OFF", and press the SET button.

- The file number reset function is deactivated.

HINT

- Until the file number reset function is turned "ON", consecutive file names are assigned. It is recommended that the file number reset function be returned to "ON" at the end of each photography session.

FORMATTING A CARD

A card must be formatted with this camera:

- After purchasing, when used for the first time, or
- If it was formatted using a personal computer or another digital camera.

The card cannot be formatted if the lock switch is set to the "LOCK" position. Proceed with the format procedure after setting the lock switch to the unlocked position.

1 Display the Option Screen (page 104).

2 Select the format icon , and press the SET button.

- The Format Screen appears.
- In normal use, a full format is not necessary. However, in case a card error occurs even after normal formatting, executing a full format may resolve the problem.

FORMAT:

A normal formatting is executed.

FULL FORMAT:

The entire card is scanned and formatted. (When there is little battery power remaining, this setting cannot be selected.)

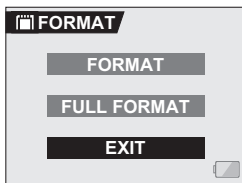

FORMATTING A CARD

- 3** Select the desired format option, and press the SET button.
- A confirmation screen appears.

- 4** Select “YES”, and press the SET button.
- Formatting begins.
 - During formatting, “FORMATTING” and “DO NOT POWER OFF” are shown on the LCD monitor.

CAUTION

Caution during formatting

- Do not turn off the power to the camera or eject the card during formatting.

Formatting erases the data

- When a card is formatted, all data recorded on the card is erased. Protected data (page 79) is also erased, so before formatting a card, any data you want to keep should be copied to your personal computer's hard disk or other storage medium.

Caution regarding disposing/transferring the card (recovering data from a reformatted card)

- If a card is reformatted or the data is erased from the card using the camera or a computer, the card's control data may be merely modified and the data itself may not be completely erased from the card.
- In some cases it may be possible to recover the data from a reformatted card using special software for that purpose. However, if the camera is used to execute a full format, it will be impossible to recover the data even by the use of data recovery software.
- If you are disposing of a card, it is recommended that you physically destroy it. If you are transferring the card to someone else to use, it is recommended that you use the camera's full format function to reformat the card, or use commercially available software for erasing card data. Managing data is the responsibility of the user.

HINT

To cancel formatting

- In step 4, select “NO”, and press the SET button.

RESETTING THE CAMERA SETTINGS

Reset the camera to the factory-preset settings.

1 Display the Option Screen (page 104).

2 Select the reset settings icon , and press the SET button.

- The Reset Settings Screen appears.

YES:

Reset to the factory-preset settings.

NO:

Do not change the settings, and return to the Option Screen.

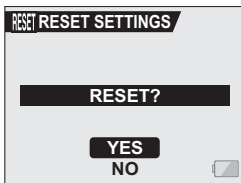

3 Select "YES", and press the SET button.

- The camera settings are reset to the factory-preset settings.

HINT

- Note that the following settings do not change with this procedure:
 - Date and time setting
 - Language setting
 - TV system setting

CHECKING THE REMAINING CARD MEMORY

You can check how many images can be captured and how much recording time is available on the card. For a table showing the maximum number of images and recording time for specific cards, please see "Possible No. of Images/Possible Shooting Time/Possible Recording Time" on page 177.

Checking the remaining number of images and video recording time

1 Set the main switch to REC, and turn on the camera (page 26).

- The remaining number of images appears in the upper left of the LCD monitor.
- The remaining video recording time appears in the upper right of the LCD monitor.
- The remaining number of images and video recording time will differ depending on the resolution and compression settings.
- When the remaining number of images or the remaining video recording time is "0", you cannot capture any more images. To capture more images, either install a new card, or save the images to a computer and then erase them (page 81) from the card.
- When the remaining number of images or the remaining video recording time is "0", it may be possible to capture a few more images by setting a lower resolution setting (see pages 55 and 56), or selecting a different image quality setting.

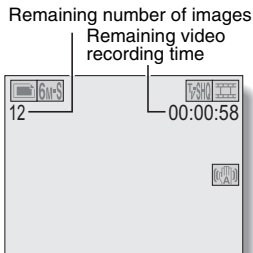

For audio recordings

1 Set the camera to the audio recording mode (page 41).

- The remaining audio recording time is shown.

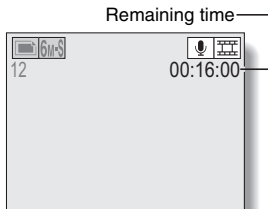

CHECKING THE REMAINING BATTERY PACK CHARGE



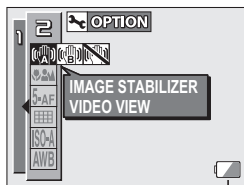

When using the battery pack, the remaining battery pack charge can be checked on the LCD monitor. Make sure to check this indicator before capturing an image. For an indication of the possible length of time for battery pack operation, see page 176.

1 Display a Shooting or Playback Setting Screen (see pages 49 and 73).

- The battery pack remaining charge indicator appears in the lower right corner of the LCD monitor.
- Due to the battery pack characteristics, when the ambient temperature is low,  may appear early for an incorrect indication of the remaining charge. Also, depending on the conditions of use of the camera or the ambient conditions (temperature, etc.), the indicated remaining charge may change. Therefore, this indication can only be used as a general approximation of the remaining charge.



Battery pack remaining charge indicator

Battery pack remaining charge indicator	Battery remaining charge
	Approx. full.
	Power is low.
	It will soon be impossible to capture or play back images.
	If this icon flashes when the still image shooting button or video clip recording button is pressed, images cannot be captured. Recharge the battery pack.

CHECKING THE REMAINING BATTERY PACK CHARGE

HINT

- If any data is present, you can also check the remaining battery pack charge on the Information Screen.
- Battery life may differ even among battery packs of the same type.
- Depending on the usage of the camera (such as the number of times the flash is used, the use of the LCD monitor, etc.) or the ambient temperature (temperatures below 10°C [50°F]) the number of images that can be saved on a fully charged battery pack will vary greatly.
- It is recommended that you prepare an extra battery pack(s) when taking pictures at a wedding or while traveling, for example, so you don't miss capturing images of important moments due to the battery pack power running out. The same is recommended for taking photos in cold environments. (In a ski area, for example, the battery pack can be kept warm in your pocket until ready to use.)

USING THE DOCKING STATION

Set your camera in the supplied docking station to recharge the battery pack as well as for easy connection to a computer, printer or TV. A remote control unit is provided for even easier operation of your docked camera (playback only).

Connect the AC adaptor to the docking station

CAUTION

- When connecting the cables, make sure that the cable plugs are correctly oriented and that they match the shapes of the terminal sockets on the devices. Push the plugs in straight when connecting them. If undue force is used to connect a cable, it may permanently damage the connector pins in the terminal socket.

Gently connect and disconnect the cable

- When connecting and disconnecting the cable, please do so with a gentle touch. Exerting a strong pull on the cable or connector may damage them.

-
- 1 Use the supplied AC adaptor to connect the DC IN terminal on the docking station to a power outlet.

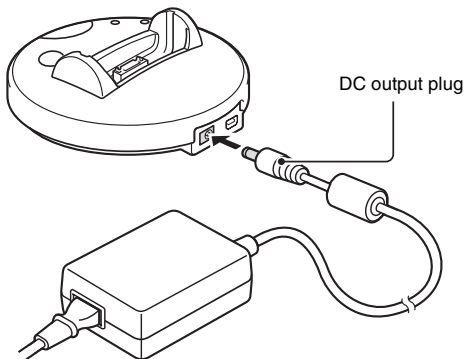

USING THE DOCKING STATION

2 Connect the supplied power cord to the AC adaptor socket.

3 Plug the power cord into an electrical outlet.

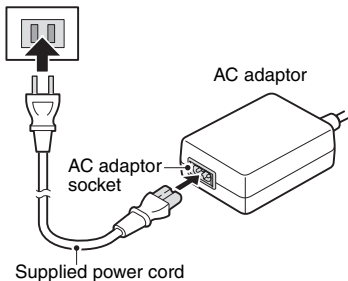

Set the camera in the docking station

1 Connect the AC adaptor (supplied) to the docking station (page 134).

2 Set the camera in the docking station.

- Set the camera securely, making sure that the camera is correctly oriented in relation to the terminal contacts in the docking station.

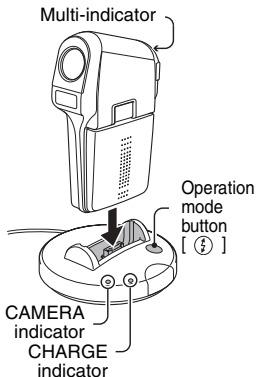

<Charging the battery pack>

- Turn the camera off or close the monitor unit before setting the camera in the docking station.
- Charging begins when the camera is set in the docking station.
- During charging, the docking station's CHARGE indicator and the camera's multi-indicator are lit red.
- If the docking station's CHARGE indicator flashes red, it indicates that the battery pack is defective or that the camera is not correctly set in the docking station. In this case, please confirm the condition of the battery pack and the position of the camera.
 - * The battery pack can be charged during playback, but not during shooting.
- When the battery pack is completely charged, the docking station's CHARGE indicator and the camera's multi-indicator turn off.
- Charging will take approximately 90 minutes.

<Connecting to a computer>

- Turn the camera on and open the monitor unit before connecting the camera to a computer.
- The camera can be used as an external drive of the computer or as a PC camera.
 - When using the camera as the computer's external drive
→ (See page 10 in the Software Pack Instruction Manual.)
 - When using the camera as a PC camera
→ (See page 25 in the Software Pack Instruction Manual.)

<Connecting to a TV>

- Turn the camera on and open the monitor unit before connecting the camera to a TV (page 137).

<Connecting to a printer>

- Turn the camera on and open the monitor unit before connecting the camera to a printer.
- By connecting the camera to a printer, you can print the still images from the card installed in the camera (page 145).

CAUTION

Note concerning using the camera and docking station

- The supplied PDS-C6 docking station is for use only with VPC-C6 (VPC-C6EX, VPC-C6EXE, VPC-C6E, VPC-C6) camera models.
- Note that if a VPC-C5 (VPC-C5EX, VPC-C5E, VPC-C5, VPC-C5GX) camera model is set in the docking station for this camera (PDS-C6), or if a VPC-C6 camera model is set in the docking station for a VPC-C5 camera model (PDS-C5), it will not operate correctly.

CONNECTING TO A TV

Use the supplied S-AV interface cable to connect the docking station to the TV.

- 1** Connect the AC adaptor (supplied) to the docking station (page 134).
- 2** Use the dedicated AV interface cable (supplied) to connect the docking station to a TV.
- 3** Open the camera's monitor unit, and set the camera in the docking station.
 - The CAMERA indicator on the docking station lights.

<When connecting to a standard video input terminal>

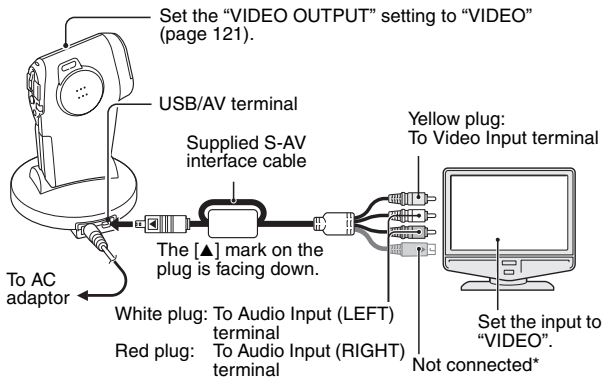

* When connected, the images are not produced normally on the TV monitor.

<When connecting to an S-VIDEO video input terminal>

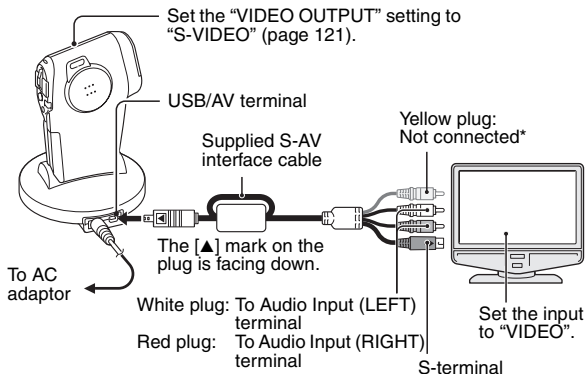

*** When connected, the images are not produced normally on the TV monitor.**

HINT

Is the docking station's CHARGE indicator lit?

- If the camera is set in the docking station with the monitor unit closed and the CHARGE indicator lights, the camera's data cannot be accessed.
- Press the operation mode button [] on the docking station to turn on the CAMERA indicator.

Is the power save (sleep) mode active?

- Press the operation mode button [] on the docking station.

CONNECTING TO A TV

Playback

- After connecting the digital camera to the television, set the TV input switch to VIDEO input.
- When an AV interface cable is connected, no image appears on the camera's LCD monitor.
- The playback method is the same as when viewing images on the camera's LCD monitor.
- The playback operations can be controlled with the remote control unit (page 140).
- The same playback procedure as when playing back with the camera is used to play back audio recordings as well.

Audio playback: see page 48

CAUTION

Insert and pull out the cable carefully

- When connecting the cables, make sure that the cable plugs are correctly oriented and that they match the shapes of the terminal sockets on the devices. Push the plugs in straight when connecting them. If undue force is used to connect a cable, it may permanently damage the connector pins in the terminal socket.
- Do not use excessive force when connecting and disconnecting cables.

PREPARING AND USING THE REMOTE CONTROL UNIT

Use the supplied remote control unit to play back data from the docked camera.

Remote control unit button operation

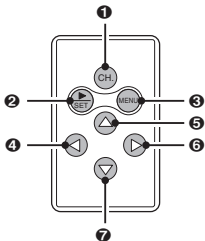

- ① **CH. (channel)**
 - Switch the remote control code (page 144).
- ② **SET**
 - Same operation as the camera's SET button.
- ③ **MENU**
 - Same operation as the camera's MENU button.
- ④ **[◀]**
 - Works the same as toggling the camera's SET button to the left.
- ⑤ **[▲]**
 - Works the same as toggling the camera's SET button up.
- ⑥ **[▶]**
 - Works the same as toggling the camera's SET button to the right.
- ⑦ **[▼]**
 - Works the same as toggling the camera's SET button down.

PREPARING AND USING THE REMOTE CONTROL UNIT

Prepare the remote control unit

The remote control unit comes with the battery already installed at the time of purchase.

1 Pull out and remove the protective battery insulating sheet.

- The remote control unit becomes operative when the insulating sheet is removed.

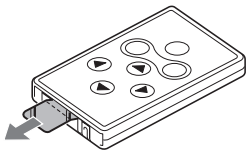

Replacing the remote control unit battery

The life of the lithium battery will depend on your use of the remote control unit, but as a general guideline, it will require replacement about once a year. Follow the steps below to replace the CR2025 Lithium battery (sold commercially).

1 Pull out the battery holder from the remote control unit.

- Push in the tab to release the battery holder, and then pull it out.

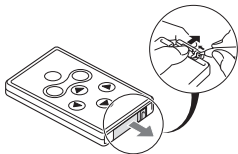

2 Remove the battery.

3 Insert a new battery (CR2025) in the holder.

- Wipe the new battery with a soft, dry cloth, and then insert it with the (+) mark facing downward.

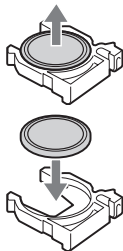

-
- 4** Reinsert the battery holder in the remote control unit.

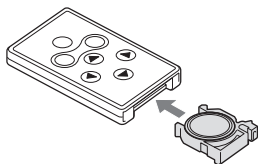

How to use the remote control unit

-
- 1** Set the camera in the docking station, and press the docking station's operation mode button [] so that the CAMERA indicator lights green (page 134).

-
- 2** To operate the remote control unit, aim the remote control unit's infrared emitter at the docking station's remote control sensor.
- The remote control unit can be used at an angle that is displaced 15 degrees horizontally from the remote control sensor on the front of the docking station, at a distance of up to 7 meters.

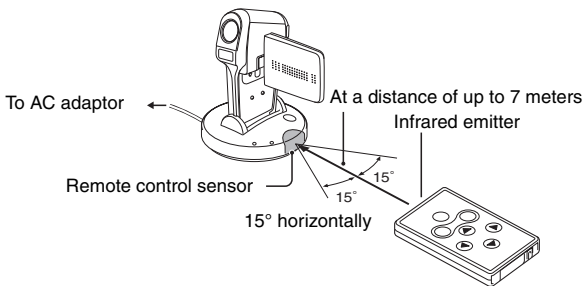

PREPARING AND USING THE REMOTE CONTROL UNIT

HINT

Is the power save (sleep) mode active?

- Press the operation mode button [] on the docking station.

CAUTION

- If the remote control unit is operated in sunlight or under inverter lighting, the remote control receiving range may become shorter. This is a characteristic of the infrared remote control unit and is not a defect. To avoid this malfunction when operating the remote control unit, take care to shield the remote control sensor from strong light.

Changing the remote control code

The remote control unit will also work with other Sanyo cameras that can be operated by infrared remote control. When more than one camera is present, it is recommended to change the remote control code to ensure that only the intended camera operates when the remote control unit is used. The remote control code is set to "RC CODE 1" at the time of purchase.

<Changing the remote control code from "RC CODE 1" to "RC CODE 2">

1 Aim the infrared emitter at the remote control sensor on the docking station.

2 Hold down the CH button and press the [▼] button for about 3 seconds.

3 Press a button on the remote control unit and check that the camera is receiving correctly.

- The remote control codes are retained even if the batteries in the remote control unit and camera are replaced.
- If the remote control codes for the remote control unit and the camera do not match, the remote control unit cannot be used to operate the camera.

<Resetting the remote control code to "RC CODE 1">

1 Aim the infrared emitter at the remote control sensor on the docking station.

2 Hold down the CH button and press the [▲] button for about 3 seconds.

DIRECT PRINTING

Your camera supports the PictBridge function. By connecting the camera directly to a PictBridge-enabled printer, the camera's LCD monitor can be used to select images and initiate printing (PictBridge printing).

Print preparations

- 1** Connect the AC adaptor (supplied) to the docking station (page 134).
- 2** Turn on the printer, and use the dedicated USB interface cable (supplied) to connect the docking station's USB/AV terminal to the printer's USB connector socket.
- 3** Open the camera's monitor unit, and set the camera in the docking station.
 - The USB Connection Screen appears on the camera's LCD monitor.

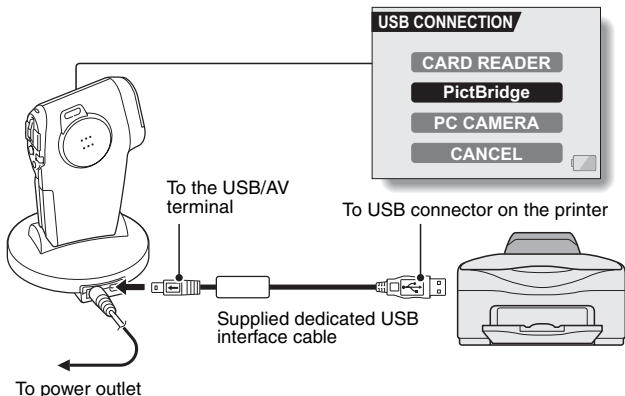

-
- 4** Select “PictBridge”, and press the **SET** button.
- The Print Settings Screen appears.

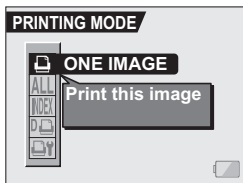

CAUTION

Insert and pull out the cable carefully

- When connecting the cables, make sure that the cable plugs are correctly oriented and that they match the shapes of the terminal sockets on the devices. Push the plugs in straight when connecting them. If undue force is used to connect a cable, it may permanently damage the connector pins in the terminal socket.
- Do not use excessive force when connecting and disconnecting cables.

Caution when connecting a printer

- If the power to the printer is turned off while it is connected, the camera may not operate correctly. If the camera does not operate correctly, disconnect the USB interface cable, turn off the camera, and then reconnect the cable.
- During PictBridge printing, the camera's button operation response is slower.
- If the camera is powered by the battery pack for printing, make sure that the remaining battery charge is sufficient.

DIRECT PRINTING

To select one image and print it (one image)

Procedure to select one still image and print it.

1 Complete the printing setup (page 145).

2 Select the one image icon , and press the SET button.

- The screen to select images for printing appears.

3 Toggle the SET button to the left or right to display the image you wish to print.

- Specify the image to print.

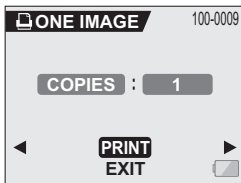

4 Specify the number of prints.

- ① Select "COPIES", and press the SET button.
- ② Toggle the SET button up or down to specify the number of prints.
- ③ Press the SET button.
 - "PRINT" is selected.

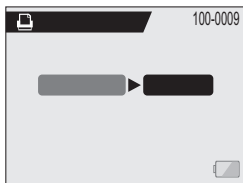

5 Press the SET button.

- Printing begins.

HINT

To cancel printing

- ① During printing, toggle the SET button down.
 - The Confirm Cancel Printing Screen appears.
- ② Select "YES", and press the SET button.
 - If "EXIT" is selected and the SET button is pressed, printing resumes.

DIRECT PRINTING

To print all the images (all images)

Print all of the images on the card.

1 Complete the printing setup (page 145).

2 Select the all images icon **ALL**, and press the **SET** button.

- The Print All Images Screen appears.
-

3 Select **"PRINT"**, and press the **SET** button.

- Printing begins.

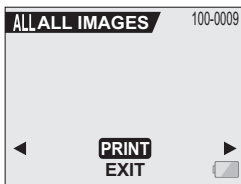

CAUTION

Printing is not possible if there are more than 999 still images in the card.

- Delete unwanted images before printing.

Thumbnail prints (index)

Make an index print of all the images on the card.

1 Complete the printing setup (page 145).

2 Select the index print icon **INDEX**, and press the **SET** button.

- The Index Print Screen appears.

3 Select “**PRINT**”, and press the **SET** button.

- Printing begins.

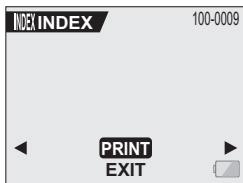

DIRECT PRINTING

To print the images that are set to print (print reserved images)

Procedure to print all the images that are set to print.

1 Make the print settings (page 83), and complete the printing setup (page 145).

2 Select the DPOF icon , and press the SET button.

- The Print Scheduled Images Screen appears.

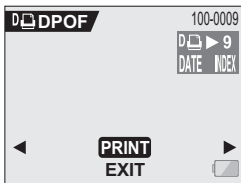

3 Select "PRINT", and press the SET button.

- Printing begins.
- Printing begins about 1 minute after the SET button is pressed.

HINT

- In step 2, if you toggle the SET button to the left or right, you can confirm the images that are set to print and their DPOF settings.

CAUTION

- Reserved images printing  is not possible if a printer is used that does not support your camera's DPOF function.

To change the printer settings and print images (change printer settings)

Images are printed according to settings specified by the camera, such as paper type, size, layout, printing quality, etc.

1 Complete the printing setup (page 145).

2 Select the printer settings icon , and press the SET button.

- The Printer Settings Screen appears.

MEDIA TYPE:

Specify the type of paper used for printing.

PAPER SIZE:

Specify the size of paper used for printing.

LAYOUT:

Specify how the images are to be arranged on the paper.

QUALITY:

Select the print quality for the images.

DATE STAMP:

Print the date the photo was taken.

EXIT:

Return to the PictBridge Screen.

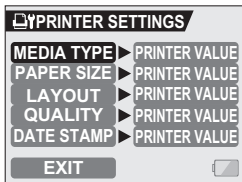

DIRECT PRINTING

3 Adjust the printer settings.

- ① **Toggle the SET button up or down to select a printer setting parameter, and press the SET button.**
 - The screen to set the selected parameter appears.
- ② **Toggle the SET button up or down to adjust the setting, and press the SET button.**
 - The selected parameter is set, and you are returned to the Printer Settings Screen.
 - Follow the same procedure to adjust the other parameters, as desired.
 - The contents of the settings that can be made for each parameter will differ depending on the printer.

<When "PRINTER VALUE" is selected>

- The images will be printed according to the settings specified on the printer side.

4 Select "EXIT", and press the SET button.

- You are returned to the Printing Mode Screen.

HINT

- The printer setting parameters will differ depending on the printer that is connected.
- To use printer functions which do not appear on your camera's Printer Settings Screen, select "PRINTER VALUE".
- If a function set by the camera is not available in the printer, the camera's printer settings will automatically change to "PRINTER VALUE"

USING THE CABLE ADAPTOR

Using the supplied adaptor, you can connect the camera to a computer, printer, TV or AC adaptor, etc., without using the docking station.

- 1 Attach the adaptor to the docking station terminal on the bottom of the camera.**
 - 2 Various devices can be connected to the adaptor terminals.**
-

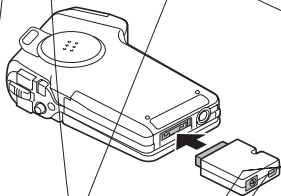

HINT

The remote control unit cannot be used.

- Unlike when using the camera in the docking station, when the adaptor is connected, the remote control unit cannot be used to operate the camera. To play back data from the camera, use the operation buttons on the camera.

COMMONLY ASKED QUESTIONS

If you have a question about the camera operation, you might find the answer in this compilation of commonly asked questions.

	Question	Answer	Action
Power	Why doesn't the power turn on?	Due to cold temperatures, the battery pack temporarily lost its power.	Place the camera in your pocket to warm it up before using it.
	Why is the battery pack consumed so quickly even after it was fully recharged?	The ambient temperature is very low.	Keep the battery pack in an environment of 10 to 40°C (50 to 104°F).
	Why doesn't recharging end?	The battery pack life has expired.	Replace with a new battery pack. If this is not effective, consult your dealer.
	Why does the  icon appear?	The remaining battery pack power is low.	Use the supplied AC adaptor, or replace the battery pack with a fully charged one.
Shooting	Why does the multi-indicator flash red?	Recorded data is being saved on the card.	Not a malfunction. Wait until the multi-indicator turns off.
	Why doesn't the flash operate?	The camera has determined that the image is bright enough and the flash is not necessary.	Not a malfunction. Capture the image; the camera will determine when the flash is necessary.

	Question	Answer	Action
Shooting	Are the settings retained even after the camera is turned off?	—	All settings except the self-timer and the exposure correction are retained even after the camera is turned off.
	Which resolution setting should I use?	—	Select the resolution setting according to the intended use: 6M-S : Appropriate for printing letter-size or larger, and for printing a close-up of part of a photo (trimming). 3M-M , 2M : For printing standard photo (photo service) sizes. 0.3M : For photos displayed on a web page, or sent as e-mail attachments.
	What is the difference between the digital zoom and the optical zoom?	—	Because shooting with the optical zoom uses the optics of a physical lens, you can shoot without losing minute details in the image. The digital zoom, on the other hand, works by magnifying a portion of the image that hits the CCD sensor and may produce a coarser image.

COMMONLY ASKED QUESTIONS

	Question	Answer	Action
Shooting	How can I get the distant view into focus?	—	Set the scene select function to the landscape  mode when photographing. Or, set the focus range setting to manual focus [MF], and set the distance to ∞.
	The video clip I shot outdoors is completely white.	—	Set the flicker-reduction setting to off.
LCD monitor	When used in cold weather, why does the image seem to leave traces as it moves?	Condition due to the liquid crystals.	Not a malfunction. Spots that appear in the LCD monitor only appear in the monitor and will not be recorded with the images.
	Why does the displayed image contain some red, blue and green dots, or why are black spots visible?		

	Question	Answer	Action
Viewing images	Why is the image too bright?	The subject was too bright.	When capturing an image, devise a way to compensate for a bright subject, for example, by changing the shooting angle.
	Why is the image out of focus?	The focus is not locked properly.	Hold the camera correctly and slowly press the still image shooting button halfway to lock the focus. Then press the still image shooting button all the way to capture the image.
	Why is there no image (□ is shown)?	This may happen when trying to play back images stored on a card from a different digital camera.	Play back images that were recorded on a card using this camera.
	Why do vertical stripes appear?	If a bright subject is shot in the video clip shooting mode, vertical stripes may appear on the LCD monitor or in the image.	Not a malfunction.

COMMONLY ASKED QUESTIONS

	Question	Answer	Action
Viewing images	Why isn't the magnified image clear?	Due to the characteristics of the camera, magnified images appear less clear.	Not a malfunction.
	Why isn't the captured image clear?	The image was captured using the digital zoom.	Not a malfunction.
	Can I play back image and sound data that I edited using my computer?	—	We cannot guarantee the accurate playback of data that has been edited using a computer.
	Why is there a motor-like sound during video clip playback?	The sound of the camera's mechanical action was recorded.	Not a malfunction.
Connecting to a TV	Why is there no sound?	The volume on the TV is set to the minimum.	Adjust the volume on the TV.
		The playback volume of the camera is set to 0.	Increase the playback volume of the camera.
Printing	Why does a message appear during PictBridge printing?	There is a problem with the printer.	Please refer to the instruction manual for your printer.

	Question	Answer	Action
Misc.	The "CANNOT EDIT VIDEO" message appears.	You have attempted to join video clips having different resolutions or frame rates.	Select video clips that have the same resolution or frame rates.
	Why is a noise heard from a nearby TV or radio during battery recharging?	Electromagnetic waves are emitted from the AC adaptor.	Move the AC adaptor further away from the TV or radio when recharging the battery pack.
	Why does the "CARD FULL" message appear?	There is no more available memory on the card.	Erase unnecessary data, or use a card that has more memory available.
	Why does the "CARD IS PROTECTED" message appear?	The lock switch on the card is in the locked (protect) position.	Move the lock switch to the unlocked position.
	Why can't the camera be operated?	A temporary internal circuitry problem may be the cause.	Remove the AC adaptor and the battery pack from the camera, wait a few minutes, then reinstall the battery pack and try again.

COMMONLY ASKED QUESTIONS

	Question	Answer	Action
	Can I use my camera abroad?	—	When the camera is connected to a TV, you can switch the camera's video output to NTSC or PAL. If you have questions about using the AC adaptor and power cord abroad, please consult with a dealer near you for advice.
Misc.	Why does the "SYSTEM ERROR" message appear?	A problem has occurred within the camera or card.	Check the following items: ① Remove the card and then install it again. ② Remove the battery pack and then install it again. ③ Install a different card. If "SYSTEM ERROR" still appears after performing the above steps, then take the camera to the dealer for service.

TROUBLESHOOTING

Before taking your camera to the repair shop, check the following table for a possible solution to the problem.

CAMERA

	Problem	Cause	Action	Reference page
Power	No power.	The battery pack is dead.	Recharge the battery pack, or replace with a new battery pack. Or connect the AC adaptor (supplied).	19, 22, 24, 25
		The battery pack has not been inserted correctly.	Reinsert the battery pack, making sure to orient it correctly.	
	The camera turns off by itself.	The power save function is operating.	Turn on the camera again.	26
	The camera's battery pack cannot be charged.	The camera is turned on.	Turn off the camera.	—
Shooting	An image is not captured when the still image shooting button or video clip recording button is pressed.	The power is not turned on.	If the power save function was activated, turn the camera on before shooting. If the camera was turned off, press the ON/OFF button to turn it on.	26

TROUBLESHOOTING

	Problem	Cause	Action	Reference page
Shooting	An image is not captured when the still image shooting button or video clip recording button is pressed.	The maximum number of images that can be captured or the maximum video clip recording time has been reached.	Install a new card.	21
			Erase the images that are not necessary.	81
	The flash does not operate.	The flash off mode is selected.	Set the flash to automatic flash mode or forced flash mode.	60
		The battery pack is dead.	Recharge the battery pack, or replace with a new battery pack. Or connect the AC adaptor (supplied).	19, 22, 24, 25
	The digital zoom does not work.	The still image mode is set to [10M] .	Set the still image mode to [6M+] .	56, 118
		The digital zoom setting is set to "OFF".	Set the digital zoom setting to "ON".	
	A warning tone (beep-beep-beep) sounds, and it is not possible to take a picture using the self-timer.	The battery pack is consumed.	Install a sufficiently recharged battery pack. Or connect the AC adaptor (supplied).	19, 22, 24, 25

	Problem	Cause	Action	Reference page
Shooting	When zooming in or out, the zoom movement stops momentarily.	The optical zoom has moved to the maximum magnification position.	Not a malfunction. Release the zoom switch, and press it again.	39
	There is noise in the captured image.	The ISO sensitivity setting is too high.	Set the ISO sensitivity to a lower setting.	70
LCD monitor	No playback image appears.	The main switch is not set to PLAY.	Set the main switch to PLAY.	43
Viewing images	The image is too dark.	The flash was blocked by a finger or other object.	Hold the camera correctly, and make sure the flash is not obstructed.	30
		The subject was too far away.	Capture the image in the range of operation of the flash.	174
		The subject was lit from behind.	Use the forced flash mode.	60
			Use the exposure correction function.	40
			Use the spot light-measuring mode.	69
There is not enough light.	Adjust the ISO sensitivity setting.	70		

TROUBLESHOOTING

	Problem	Cause	Action	Reference page
Viewing images	The video clip picture is flickering.	The video clip was filmed under fluorescent lighting.	Set the flicker-reduction setting to on.	117
	The image is too bright.	The forced flash mode is selected.	Select a different flash mode.	60
		The subject was too bright.	Use the exposure correction function.	40
		The ISO sensitivity setting is incorrect.	Set the ISO sensitivity to [ISO-A] .	70
	Red-eye correction was not successful.	The red-eye effect area could not be recognized.	Not a malfunction.	92
	The image is not in focus.	The subject is too close to the camera.	Capture the image with the subject within the photographable range. Select the correct focus setting for your needs.	66
The focus setting is not correct.				

	Problem	Cause	Action	Reference page
Viewing images	The image is not in focus.	The camera moved when the still image shooting button was pressed. (camera shake)	Hold the camera correctly and slowly press the still image shooting button half-way to lock the focus. Then press the still image shooting button all the way to capture the image.	30, 36
		The focus is not locked properly.		
		The lens is dirty.	Clean the lens.	
	The colors of the images captured indoors are not correct.	This is due to ambient lighting.	Capture the image using the forced flash mode.	60
		The white balance setting is incorrect.	Set the white balance setting correctly.	71
	A part of the image is missing.	The strap or a finger was blocking the lens.	Hold the camera correctly, and make sure the lens is not obstructed.	30
	"NO IMAGE" is shown.	There are no recorded files for the selected playback mode.	Play back after capturing images or making audio recordings.	—
	During audio playback, there is no sound.	The playback volume setting on the camera is too low.	Select the playback volume icon  and adjust the volume.	78

TROUBLESHOOTING

	Problem	Cause	Action	Reference page
Connecting to a TV	There is no color in the image. The image is distorted.	The TV system setting is not correct.	Select the correct TV system setting.	121
	No image or sound.	The digital camera is not correctly connected to the TV.	Follow the instructions to make the connection correctly.	121, 137
		The TV input is not set correctly.	Set the input on the TV to "VIDEO".	
	There is no sound.	The playback volume setting on the camera is too low.	Adjust the playback volume.	78
	The edge of the image is cut off.	This is a characteristic of the TV.	Not a malfunction.	—
Image editing	You cannot edit or rotate an image.	The protect mode is set.	Cancel the protect mode.	79

	Problem	Cause	Action	Reference page
Misc.	The "NO CARD" message appears.	No card is inserted.	Turn off the power and insert a card.	21
	The "PROTECTED" message appears and the data cannot be erased.	You have attempted to erase data that is protected from accidental erasure.	Set the protect setting for the data to OFF.	79
	The audio guide does not sound.	The audio guide setting is set to "OFF".	Set the audio guide setting to "ON".	110
	The recording capacity is less than that indicated in the section "Possible No. of Images/ Possible Shooting Time/ Possible Recording Time" (page 177).	The recording capacity is less than the value specified for the card.	Depending on the card, the capacity may be less than the specified value. Please refer to the instructions that accompanied the card.	177

TROUBLESHOOTING

DOCKING STATION











	Problem	Cause	Action	Reference page
Remote control unit	The remote control unit does not seem to work.	The remote control unit is aimed at the TV (not at the docking station).	Aim the remote control unit at the remote control sensor on the docking station (within a range of about 30 degrees horizontally from remote control sensor).	140, 141
		Something is obstructing the space between the remote control unit and the remote control sensor on the docking station.	Remove or move the obstructing object.	
		The remote control unit battery is consumed.	Replace with a new battery.	
		The remote control unit battery is not correctly inserted.	Take care that the (+) and (-) poles are correctly oriented.	

	Problem	Cause	Action	Reference page
Remote control unit	The remote control unit does not seem to work.	The remote control unit is too far from the remote control sensor on the docking station.	Operate the remote control unit from a position up to 7 meters from the docking station.	140, 141
		The remote control codes for the remote control unit and the docking station are different.	Change the remote control code.	144





TROUBLESHOOTING

Notes regarding the Scene Select feature and filters







Scene Select

Setting	Remarks
Sports 	Focus range:  cannot be selected.
Portrait 	
Landscape 	
Night view 	
Fireworks 	Focus range: Fixed at  Flash: Fixed at 
Lamp 	Still image mode: Fixed at 0.3M . Flash: Fixed at  Focus range:  cannot be selected.

Filter

Setting	Remarks
Cosmetic 	Focus range:  cannot be selected.
Monochrome 	Still image mode: 10M cannot be selected.
Sepia 	Focus range:  cannot be selected.

About the scene select function and focus range settings







- The scene select function changes to **AUTO** when the focus range is set to .
- Even if you set the focus range to ,  or **MF**, it changes to  when the scene select function is set to anything other than **AUTO**.
- When the scene select is set to , the focus range setting changes to .

SPECIFICATIONS

Camera

Type	Digital movie camera (recording and playback)
Recorded image file format	Still images: JPEG format (DCF, DPOF, Exif 2.2 compliant) Note: Designed mainly by the Japan Electronics and Information Technology Industries Association (JEITA), DCF (Design rules for Camera File system) is standard for digital still camera image files to provide interoperability between digital photography devices for the images stored on removable memory cards. However, it is not guaranteed that all devices will support the DCF standard. Video clips: Conforms to ISO-standard MPEG-4 format Audio: MPEG-4 audio (AAC compression) 48 kHz sampling rate, 16-bit stereo format
Data storage media	SD Memory Card
Camera effective number of pixels	Approx. 6 million pixels
Image sensor	1/2.5-inch CCD Virtual number of pixels: Approx. 6.37 million pixels, interlace scan, primary color filter
Still image shooting mode (recording resolution)	10M : 3,680 × 2,760 pixels 6M-H : 2,816 × 2,112 pixels (low compression) 6M-S : 2,816 × 2,112 pixels (standard compression) 3M : 1,536 × 2,048 pixels (vertical position) 2.0M : 1,600 × 1,200 pixels 0.3M : 640 × 480 pixels

SPECIFICATIONS

Video clip shooting mode (recording resolution, frame rate, bit rate)	 : 640 × 480 pixels, 30 fps 3 Mbps  : 640 × 480 pixels, 30 fps 2 Mbps  : 320 × 240 pixels, 30 fps 640 kbps  : 320 × 240 pixels, 15 fps 384 kbps  : 176 × 144 pixels, 15 fps 256 kbps * The 30 fps frame rate of this camera is 29.97 fps, and the 15 fps frame rate is 14.985 fps.	
White balance	Full-auto TTL, manual setting possible	
Lens	Optical 5.0x zoom lens	f=6.3 mm to 31.7 mm (35 mm film camera conversion f=38 mm to 190 mm) Autofocus, 9 groups, 12 elements (including three with five aspheric surfaces) Galvanometer iris Internal ND filter
Aperture	Open F=3.5 (Wide) to 4.7 (Tele) Smallest F=8.0 (Wide) to 10.7 (Tele)	
Exposure control type	Programmable AE Exposure correction available from the Shooting Setting Screen (0±1.8EV in 0.3EV steps)	
Light-measuring mode	Multi-section measuring, center-weighted measuring, spot measuring	
Range	Total mode: 10 cm (3.94 in.) to infinity (Wide end) 80 cm (31.50 in.) to infinity (Tele end) Standard mode: 80 cm (31.50 in.) to infinity Super macro mode: 1 cm (0.39 in.) to 80 cm (31.50 in.) (Wide end only)	
Digital zoom	For shooting: 1x to approx. 12x For playback: 1x to 58x (varies with resolution)	
Shutter speed	Still image shooting mode: 1/2 to 1/2,000 sec. (Maximum approx. 4 seconds when scene select function set to lamp ) (During flash: 1/30 to 1/2,000 sec.) Video clip shooting mode: 1/30 to 1/10,000 sec.	

Sensitivity	<p>Still image shooting mode: Auto (equivalent to ISO 50 to 200)/equivalent to ISO 50, ISO 100, ISO 200, and ISO 400 (switchable from Shooting Setting Screen) (Maximum ISO sensitivity up to 3,600 variation: when scene select function is set to lamp )</p> <p>Video clip shooting mode: Auto (equivalent to ISO 450 to 3,600)/equivalent to ISO 450, ISO 900, ISO 1,800, and ISO 3,600 (switchable from Shooting Setting Screen)</p>	
Image stabilizer	Electronic	
LCD monitor	2.0-inch low-temperature polysilicon TFT color liquid crystal display, transparent Approx. 210,000 pixels (Frame coverage: Approx. 100%)	
Flash working range	GN = 3 Approx. 10 cm (3.94 in.) to 1.2 m (3.94 ft.) (Wide) Approx. 80 cm (2.62 ft.) to 90 cm (2.95 ft.) (Tele)	
Flash modes	TTL-type AF (5-point range finder/spot focus), manual focus (16 steps)	
Focus	TTL-type AF (5-spot metering AF: Still image shooting mode; Continuous AF: Video clip shooting mode), manual focus	
Self-timer	Approx. 2-second delay, 10-second delay	
Time/date	Recorded with image data	
Ambient environment	Temperature	0 to 40°C (32 to 104°F) (operation), -20 to 60°C (-4 to 140°F) (storage)
	Humidity	30 to 90% (operating, no condensation) 10 to 90% (storage, no condensation)
Power supply	Battery pack (supplied)	Li-ion battery pack (DB-L20) × 1
	AC adaptor (supplied)	VAR-G8
Power consumption	3.1W (When using the Li-ion battery during recording)	

SPECIFICATIONS

Dimensions (excluding protrusions)	68 (W) × 108 (H) × 23 (D) mm 2.68 (W) × 4.25 (H) × 0.91 (D) in. (Maximum dimensions) Volume: Approx. 124 cc
Weight	Approx. 140 g (4.9 oz.) (Only the camera [without battery pack and card])

Camera connectors

USB/AV (communication/ sound and image output) terminal	Regrouped jack	
	Audio output	265 mVrms (−9 dBs), 12 kΩ or less, stereo
	Video output	1.0 Vp-p, 75 Ω unbalanced, sync negative, composite video NTSC color TV system/PAL TV system (switchable from the Option Screen)
	S-video output	Y signal: 1.0 Vp-p, 75 Ω, unbalanced, sync negative C signal: 0.286 Vp-p, 75 Ω, unbalanced NTSC color TV system/PAL color TV system (switchable from the Option Screen)
	USB	USB 2.0 High-speed
DC IN (external DC power input) terminal	DC 5.0 V (for exclusive use with the supplied AC adaptor [VAR-G8])	

Battery life

Shooting	Still image shooting mode	140 images: CIPA standard (when a Toshiba 128MB SD Memory Card is used)
	Video clip recording mode	60 minutes: Recorded in TV-SHQ mode (640 × 480 pixels, 30 fps)
Playback		150 minutes: LCD monitor on, continuous playback

- Until battery pack runs out when using a fully charged battery pack at a 25°C (77°F) ambient temperature.
- The operation time may vary depending on the conditions of the battery pack and the conditions of use. Especially when used at temperatures below 10°C (50°F), the battery pack operation time is drastically reduced.

SPECIFICATIONS

Possible No. of Images/Possible Shooting Time/ Possible Recording Time

The table shows the possible number of captured images and the possible recording time for a commercially available SD Memory Card (128MB, 512MB, 1GB).

Shooting/ recording mode	Resolution setting	SD Memory Card		
		128 MB	512 MB	1 GB
Still image mode	10M	37 images	151 images	297 images
	6M-H	42 images	171 images	338 images
	6M-S	64 images	257 images	507 images
	3M-M	120 images	483 images	953 images
	2.0M	191 images	766 images	1,510 images
	0.3M	979 images	3,920 images	7,740 images
Video clip mode	17-SHQ	5 min. 13 sec.	20 min. 59 sec.	41 min. 23 sec.
	17-HQ	7 min. 36 sec.	30 min. 34 sec.	1 hr.
	17-S	20 min. 3 sec.	1 hr. 20 min.	2 hr. 38 min.
	10-HQ	28 min. 57 sec.	1 hr. 56 min.	3 hr. 49 min.
	10-S	37 min. 14 sec.	2 hr. 29 min.	4 hr. 54 min.
Audio recording mode	—	2 hr. 7 min.	8 hr. 32 min.	16 hr. 49 min.

- The maximum continuous shooting time at the 17-S setting is 5 hours 30 minutes. The maximum continuous shooting time at the 10-HQ and 10-S settings is 7 hours.
- Up to 13 hours of continuous audio recording is possible.
- 1GB: when an SD Memory Card by Sandisk is used.
- Even with cards of the same capacity, the amount of data that can actually be stored may differ depending on the card brand, etc.
- The continuous shooting time for each video clip will differ depending, for example, on the card capacity, environmental conditions (temperature and shooting conditions, etc.).

Concerning the multi-indicator

The camera's multi-indicator will light, flash, or be off, depending on the different camera operations.

Color	Multi-indicator status	Camera status	
Green	Lit	Connected to computer or printer (USB)	
	Flashing	Power save mode active	
Red	Lit	Charging	
	Flashing	Slow	Battery charge error (overcharged or defective battery)
		Fast	During self-timer photography
		Very fast	Accessing data
Orange	Lit	Connected to TV/VIDEO (AV)	

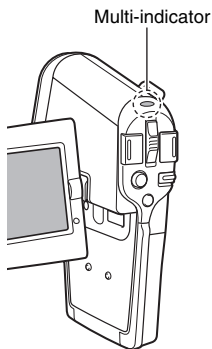

SPECIFICATIONS

Docking station

Part number	PDS-C6	
Power supply	DC 5 V	
Ambient environment	Temperature	0 to 40°C (32 to 104°F) (recharge), -20 to 60°C (-4 to 140°F) (storage)
	Humidity	10 to 85% (no condensation)
Dimensions	94 (W) × 34.1 (H) × 94 (D) mm 3.70 (W) × 1.34 (H) × 3.70 (D) in.	
Weight	Approx. 64 g (2.3 oz.)	

Remote control unit

Part number	BRC-C1	
Power supply	Lithium battery (CR2025)	
Dimensions	35 (W) × 56.6 (H) × 6.5 (D) mm 1.38 (W) × 2.23 (H) × 0.26 (D) in.	
Weight	Approx. 15 g (0.5 oz.) (including battery)	

Supplied AC adaptor

Part number		VAR-G8
Power source		AC 100 to 240 V, 50 to 60 Hz
Rated output		DC 5 V, 2.0 A
Ambient environment	Temperature	0 to 40°C (32 to 104°F) (operation), -20 to 60°C (-4 to 140°F) (storage)
	Humidity	10 to 90% (no condensation)
Dimensions		49.5 (W) × 25.5 (H) × 68.3 (D) mm 1.95" (W) × 1.00" (H) × 2.69" (D)
Weight (without power cord)		Approx. 169 g (5.96 oz.)
Power cord rated value	VPC-C6	AC 125 V, 7 A
	VPC-C6EX, C6EXE, C6E	AC 250 V, 2.5 A

- When using the supplied AC adaptor abroad, the power cord may need to be replaced in accordance with local requirements. Please contact your local dealer for details.

Supplied Li-ion battery pack

Model number		DB-L20
Voltage		3.7 V
Rated output		720 mAh
Ambient environment	Temperature	0 to 40°C (32 to 104°F) (during use, when charging) -10 to 30°C (14 to 86°F) (storage)
	Humidity	10 to 90% (no condensation)
Dimensions		39.4 (W) × 6.0 (H) × 35.5 (D) mm 1.55 (W) × 0.24 (H) × 1.40 (D) in.
Weight		Approx. 19 g (0.7 oz.)

SPECIFICATIONS

Others

Apple, Macintosh and QuickTime are trademarks or registered trademarks of Apple Computer Inc.

Windows and Windows NT are registered trademarks of Microsoft Corporation.

Software Red Eye by FotoNation™ 2003-2005 is a trademark of FotoNation® Inc.

Red Eye software© 2003-2005 FotoNation In Camera Red Eye - covered by U.S. Patent No. 6,407,777. Other patents Pending.



All other company and product names are registered trademarks or trademarks of their respective owners.

CAUTION

- It is forbidden to copy this manual, whole or in part, without prior written permission.
- All images and illustrations given in this manual are for explanation purposes and may differ slightly from that of the actual product. Also, actual specifications are subject to change without prior notice and therefore may differ from the contents of this manual.
- Sanyo Electric shall not be held responsible for any problems resulting from the use of this camera.
- Sanyo Electric declines all responsibility for damages due to improper use of the camera, failure to adhere to the instructions given in this manual, or repairs or changes done by those other than a technician authorized by the manufacturer.
- Sanyo Electric shall not be held responsible for any damage caused by optional devices or consumable items used with the camera other than those supplied with the camera or those specified by Sanyo Electric.
- Sanyo Electric shall not be held responsible for any losses or loss of revenue resulting from the loss of data caused by the malfunction, or the repairing of a malfunction, of the camera.
- The images captured with this camera will differ in quality from pictures taken with a standard film camera.

HINTS FOR TAKING PICTURES

Taking great pictures in difficult surroundings is easier than you might think. By keeping a few points in mind and choosing the correct settings, you can create photos that you'll be proud to display and share.

If images are blurred even when the autofocus is used

Your camera employs an autofocus function. When you snap a picture using the autofocus, the camera automatically adjusts the settings so that the image will be in focus. If you are getting blurred images even when using the autofocus, one or more of the following might be the reason.

■ How the autofocus works

The autofocus is activated when the still images shooting button is gently pressed halfway. Press the still images shooting button slightly, and the target mark will appear on the LCD monitor to indicate that the autofocus has been activated. Next, continue to gently press the still images shooting button all the way to snap the picture. This two-step method is the way to ensure that your photos are perfectly focused.

■ Reasons for unfocused images

- ① The still images shooting button was pressed all the way in one step.
- ② After the image was focused, the subject moved.
 - Even if camera focuses the subject once, if the distance between the camera and the subject is changed, the subject may become out of focus.
- ③ The focus setting is not set for the correct distance.
 - If you shoot a close-up subject with the camera set to the normal focus mode, or if you shoot a subject at normal distance with the camera set to the super macro (close-up) mode, the image will not be in focus.

■ Preventing blurred images

- ① Confirm that the camera is set to the correct focus mode for your subject.
- ② Hold the camera correctly, and press the still images shooting button halfway.
- ③ Wait for the target mark to appear in the LCD monitor, and holding the camera steady, gently continue to press the still images shooting button all the way down.

Following these steps for a gentle but firm pressing of the still images shooting button will ensure that you get beautifully focused photos.

HINTS FOR TAKING PICTURES

Photographing a moving subject

Situation: You would like to snap an action shot of a moving child or pet. The autofocus is activated, but because the subject is moving, the image may be blurred. In particular, when the distance between the camera and the subject is changing, it is difficult to lock the focus on the subject. Here are some hints for successfully capturing images of moving subjects.

■ Reasons for unfocused images

When the still images shooting button is gently pressed halfway, the camera's autofocus works by determining the distance between the camera and the subject. Once the subject is in focus, if it then moves before the picture is snapped, the image may be out of focus. This often happens when you once lock the focus on a subject and then wait for the right moment to snap the picture. And, conversely, a blurred image may result if you press the still images shooting button all the way in one step in an attempt to quickly capture an action scene, thus failing to activate the autofocus in time.

■ Preventing blurred images (How to use the manual focus [page 67])

In addition to the autofocus, a manual focus mode is also incorporated in your camera. In the autofocus mode, the distance between the camera and the subject is automatically determined when you press the still images shooting button halfway. In contrast to this, with the manual focus mode, you manually set the focus by specifying the correct distance between the camera and the subject before taking the picture.

■ How to photograph a moving subject

- ① Set the camera's focus mode to the manual focus. Set the focus distance to the correct distance between the camera and the subject.
- ② When the subject is at the set focus distance, gently press the still images shooting button all the way down.

<Advantage of using the manual focus>

- Images can be quickly captured without waiting for the autofocus to activate.
- Because you are presetting the focus distance, the focus can be more accurate.

<Using the manual focus effectively>

- When photographing a moving subject, press the still images shooting button just before the subject reaches the focus distance, and the shutter will be released when the subject is at the correct distance.
- Use manual focus to avoid incorrectly focused images when there is an object between the camera and the subject you wish to focus on.

Shooting portraits (portrait mode)

Points:

- Choose a background that doesn't detract from your subject.
- Move in close to your subject.
- Pay attention to lighting and how it affects your subject.

NOTE

- If the background is distracting, it will not show your subject to his best advantage. Move in closer to your subject or zoom in so that the background does not compete with the subject.
- In portrait photography your subject is clearly the central figure, so try techniques that allow the subject to stand out.
- If light is coming from behind your subject (backlit), his face will appear dark. You can get a better picture by using the flash, for example, or changing the exposure setting.

Photographing moving subjects (sports mode)

Points:

- Match the camera's movement with that of the subject.
- Set the zoom to the Wide end (wide-angle).
- Don't be too hesitant to press the still images shooting button, or you'll miss the action.

NOTE

- Tips to not missing those great action shots: Make sure you're holding the camera correctly. Keep the subject in the lens at all times, moving the camera with him while waiting for the right shot. Move your whole body—not just your arms—with the camera while shooting.
- Blurred images are more likely when the zoom is set to the Tele end than the Wide end. Set the zoom as close as possible to the Wide end.
- Learn to press the still images shooting button quickly yet smoothly the instant your photo chance occurs.

HINTS FOR TAKING PICTURES

Night photography (night view mode)

Points:

- Avoid camera shake.
- Increase the ISO sensitivity.

NOTE

- Camera shutter speed during night photography is considerable slower, so there is a much greater chance that your photographed images will be blurry. Use a tripod whenever possible, or if a tripod is not available, you can lean against a wall or pillar to help stabilize the camera.
- You can photograph your subject with the night scene in the background by using the flash. Be careful not to shoot too close to the subject, however, or your subject's face will appear too bright.
- After the flash operates, keep the camera and the subjects motionless for about 2 seconds.

Photographing scenery (landscape mode)

Points:

- Shoot using a high resolution.
- For zoom photography, use the optical zoom.
- Pay attention to picture composition.

NOTE

- When shooting with a wide-angle setting, or if you intend to enlarge the photo, the higher the resolution, the better.
- To zoom in on distant scenery, it's better to use the optical zoom. Using the digital zoom produces a coarser image. Hold the camera securely, keeping your elbows close to your body and making sure the camera is stable. Using a tripod or other means of stabilizing the camera will increase the likelihood of getting a clear photo.
- Don't forget to pay attention to picture composition; note perspective and be aware of how the placement of objects affects the scene.

SANYO

SANYO Electric Co., Ltd.

Free Manuals Download Website

<http://myh66.com>

<http://usermanuals.us>

<http://www.somanuals.com>

<http://www.4manuals.cc>

<http://www.manual-lib.com>

<http://www.404manual.com>

<http://www.luxmanual.com>

<http://aubethermostatmanual.com>

Golf course search by state

<http://golfingnear.com>

Email search by domain

<http://emailbydomain.com>

Auto manuals search

<http://auto.somanuals.com>

TV manuals search

<http://tv.somanuals.com>