

# *Fahrenheit*

## DVD-22/ DVD-22T

Single-DIN A/V Multimedia Source  
Touch Sensor  
DVD/CD/MP3/MP4  
AM/FM Radio  
Built-in TV tuner

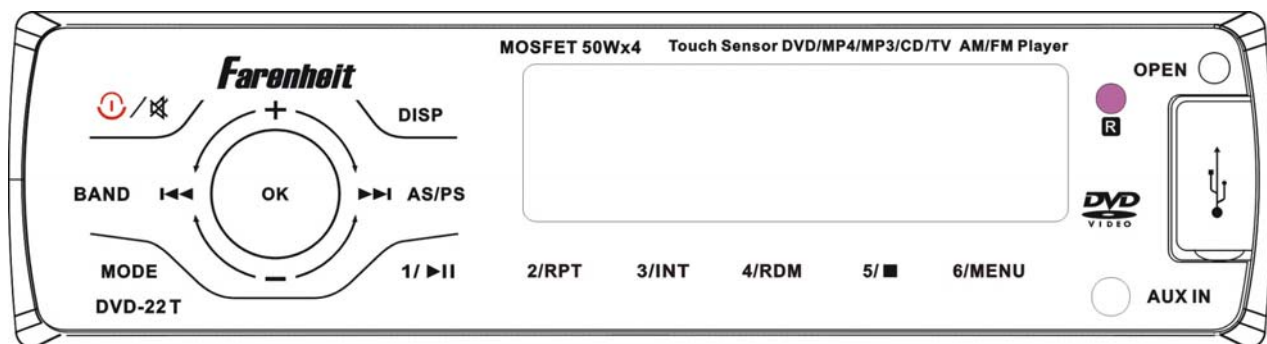

# Owner's Manual

Take the time to read through this owner's manual.  
Familiarity with installation and operation procedures will help you obtain the best  
Performance from your new DVD-receiver.



## **Table of Contents**

Table of Contents.....	1
Important Safeguards.....	2
Accessories .....	3
Installation/Un-Installation .....	4
Wiring Connections.....	5
Detachable Control Panel .....	6
Panel Controls.....	7
IR Remote Controls .....	8
General Operations.....	9
Digital Tuner.....	10
SD/MMC Cards/ USB Operations .....	11
Disc operations.....	13
MP3 overview.....	16
Setup MENU.....	17
Anti-theft system.....	21
Note on Discs.....	22
Troubleshooting Guide .....	23
Specification.....	24



## **Important Safeguards**

- Using the device at temperature below  $-10^{\circ}\text{C}$  may cause the breakage of the device. BEFORE USING PLEASE HEAT UP THE PASSENGER COMPARTMENT TO THE RECOMMENDED TEMPERATURE!
- Read carefully through this manual to familiarize yourself with this high-quality sound system.
- Disconnect the vehicle's negative battery terminal while mounting and connecting the unit.
- When replacing the fuse, be sure to use one with an identical amperage rating. Using a fuse with a higher amperage rating may cause serious damage to the unit.
- DO NOT attempt to disassemble the unit. Laser beams from the optical pickup are dangerous to the eyes.
- Make sure that pins or other foreign objects do not get inside the unit; they may cause malfunctions, or create safety hazards such as electrical shock or laser beam exposure.
- If you have parked the car for a long time in hot or cold weather, wait until the temperature in the car becomes normal before operating the unit.
- DO NOT open covers and do not repair yourself. Consult the dealer or an experienced technician for help.
- Make sure you disconnect the power supply and aerial if you will not use the system for a long period or during a thunderstorm.
- Make sure you disconnect the power supply if the system appears to be working incorrectly, (e. g, making unusual sounds, smelling strange, emitting smokes from inside or liquid having gotten inside it) Have a qualified technician check the system.
- The unit is designed for negative terminal of the battery, which is connected to the vehicle metal. Please confirm it before installation.
- Do not allow the speaker wires to be shorted together when the unit is switched on. Otherwise it may overload or burn out the power amplifier.
- Do not install the detachable panel before connecting the wire.
- Don't remove the detachable panel when encoding.

## Accessories

Package contains the following accessories for installation and operation of the unit.

(1) Washer, Spring Washer, M5 Nut	1 each	
(2) Mounting Strap	1	
(3) Screw	1	
(4) Bolt	4	
(5) Mounting Collar	1	
(6) Release Key	2	
(7) Rubber Cushion	1	



Owner's Manual



Remote Controller



Panel Carrying Case



AUX IN Cable

## Installation/Un-Installation

First complete the electrical connections, and then check them for correctness.

### Installation

This unit can be installed in any dashboard having an opening as shown on the picture. The dashboard should be 4.75 – 5.56 mm thick in order to be able to support the unit.

1. Insert mounting collar into the dashboard, and bend the mounting tabs out with a screwdriver. Make sure that lock lever (※) is flush with the mounting collar (not projecting outward).

2. Secure the rear of the unit.

After fixing mounting bolt and power connector, fix the rear of the unit to the car body by rubber cushion.

3. Insert trim plate.

When you prepare to insert trim plate, please check its direction. Once it was up side down, it cannot be fixed.

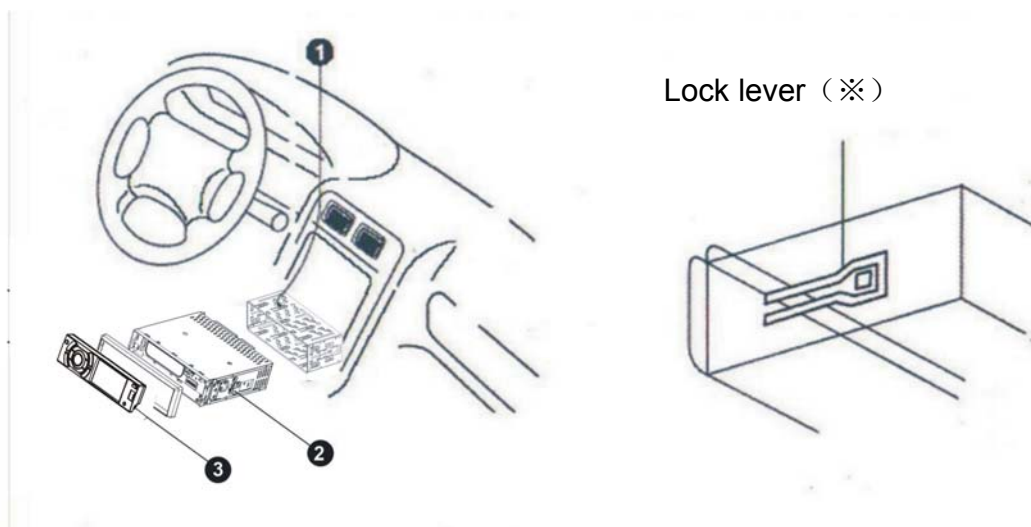

### Un-installation

Remove Trim Ring and insert Release Keys into left and right side-end holes as shown in below picture and pull the unit out of the dashboard.

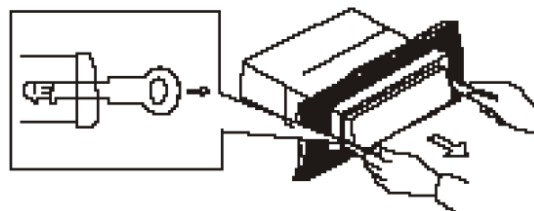

# Wiring Connections

Make sure you have good chassis ground. A good ground connection will eliminate most electrical noise problems. A good chassis ground requires a tight connection to the vehicle's metal chassis. The area around the ground connection should be clean, bare metal without rust, paint, plastic, dust, or dirt for a good electrical connection.

## Using the ISO Connector

1. If your car is equipped with the ISO connector, then connect the ISO connectors as illustrated.
2. For connections without the ISO connectors, check the wiring in the vehicle carefully before connecting, incorrect connection may cause serious damage to this unit.
3. Cut the connector, connect the colored leads of the power cord to the car battery as shown in the color code table below for speaker and power cable connections.

Location	Function	
	Connector A	Connector B
1		Rear Right(+)--Purple
2		Rear Right(-)--Purple/Black Stripe
3		Front Right(+)--Grey
4	Battery 12V (+)/yellow	Front Right(-)--Grey/Black Stripe
5	Auto Antenna/blue	Front Left(+)--White
6		Front Left((-)--White/Black Stripe
7	ACC+/red	Rear Left(+)--Green
8	Ground/black	Rear Left(-)--Green/Black Stripe

FM: 87.5-107.9MHz AM: 530-1710KHz

CAUTION: + 12V DC Negative Ground

## ISO Speaker Connection

**\*\*TV antenna is for DVD-22T only.**

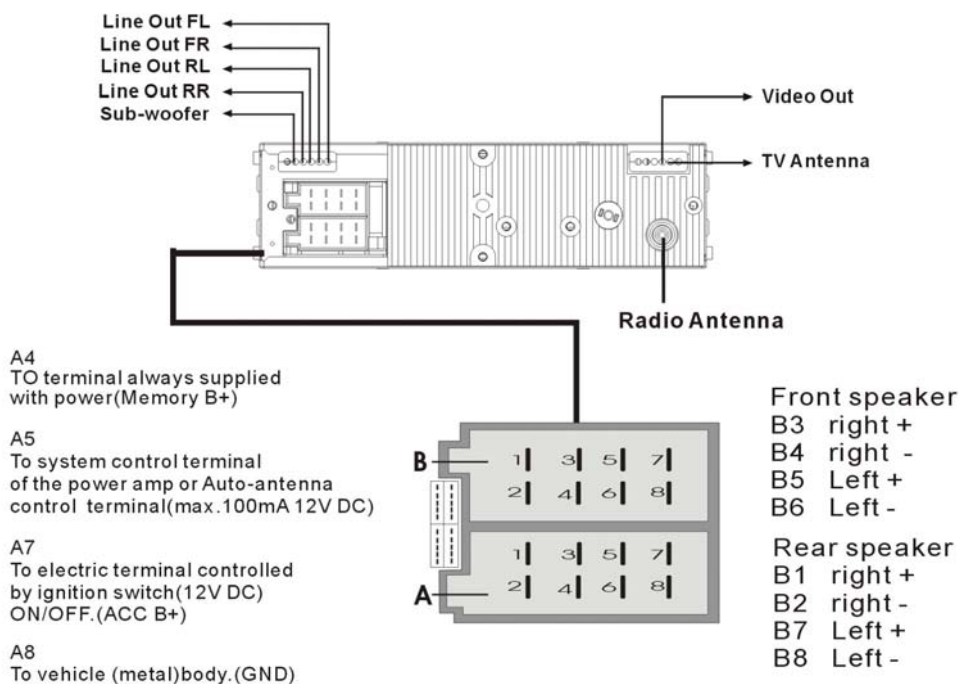



**Caution:** Do not interchange the connection of the wiring!!!

For some car models you may need to modify wiring of the supplied power cord. Contact your authorized car dealer before installing this unit.

**Remark:** When you back a car, screen display switch to Rear Camera automatically

## **Detachable Control Panel**

### Detaching the control panel

- Turn the Power off.
- Press OPEN button release the panel.
- Pull the panel out.

### Attaching the control panel

- Insert the left side of the control panel into the main unit.
- Press the control panel right side until the “click” sound is heard.

#### **Caution:**

DO NOT insert the control panel from the right side. It can damage the control panel.

The control panel can easily be damaged by shocks. After removing it, place it in a protective case and be careful not to drop it or subject it to strong shocks.

The rear connector that connects the main unit and the control panel is an extremely important part. Be careful not to damage it by pressing on it with fingernails, pens, screwdrivers, etc.

#### **Note:**

If the control panel is dirty, wipe off the dirt with soft, dry cloth only. And use a cotton swab soaked in isopropyl alcohol to clean the socket on the back of the control panel.

## Panel Controls

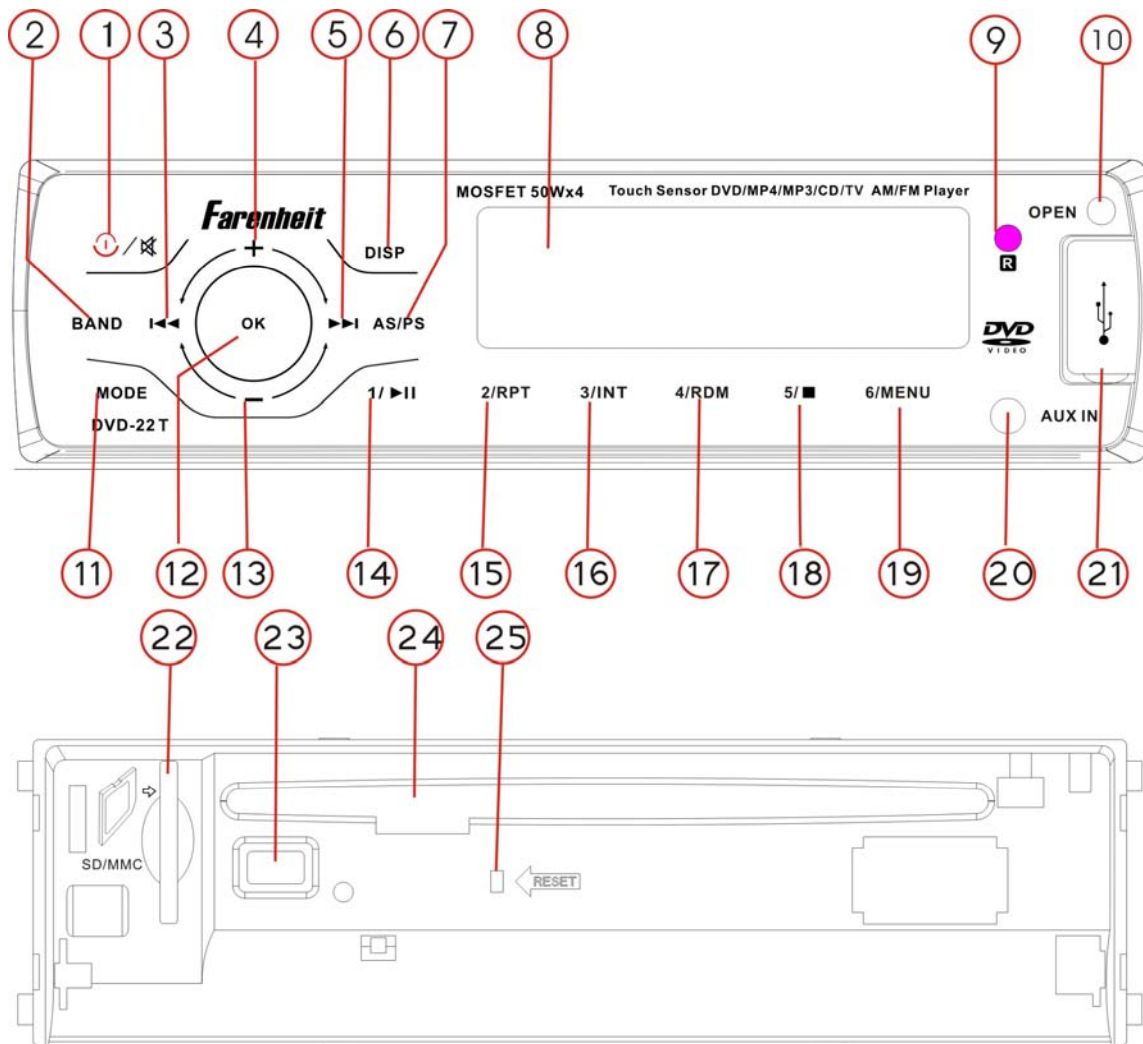

1. Power/Mute
2. BAND
3. PREVIOUS
4. VOL +
5. NEXT
6. DISP
7. AS/PS
8. LCD
9. IR sensor
10. OPEN
11. MODE.
12. OK
13. VOL-

14. PRESET 1/play pause
15. PRESET 2./RPT
16. PRESET 3./INT
17. PRESET 4/RDM
18. PRESET 5/STOP
19. PRESET 6/MENU
20. AUX IN JACK
21. USB SLOT
22. SD SLOT
23. EJECT
24. DISC SLOT
25. RESET



## IR Remote Control

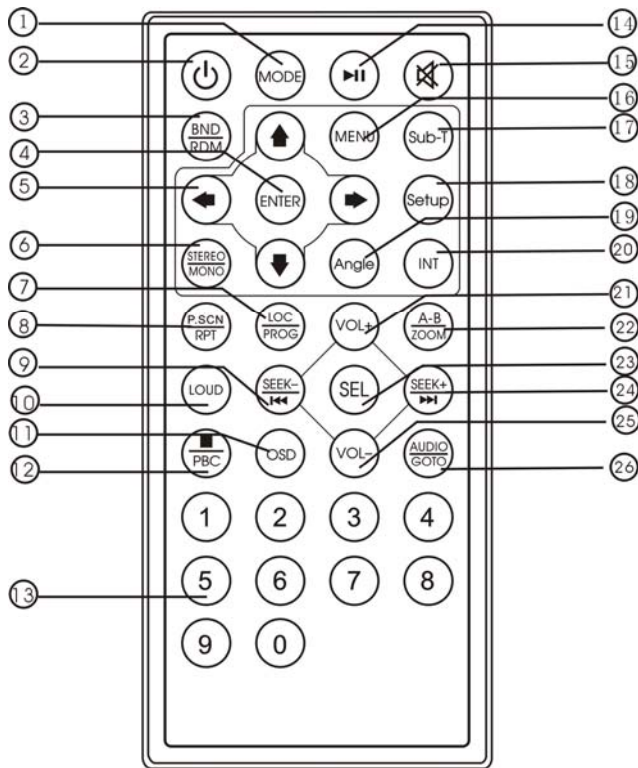

1. MODE
2. POWER
3. BND/RDM
4. ENTER
5. Cursor
6. STEREO/MONO
7. LOC/PROG
8. P.SCN/RPT
9. SEEK-/I
10. LOUD
11. OSD
12. STOP/PBC
13. Digit 0-9
- 14.
15. MUTE
16. MENU
17. SUB-T
18. SETUP
19. ANGLE
20. INT
21. VOL+
22. A-B/ZOOM
23. SEL
24. SEEK+/I
25. VOL-
26. AUDIO/GOTO

## REPLACING THE BATTERY

Remote Control comes with a CR-2025 Lithium Battery included.

1. Remove the Battery Holder from the back of the Remote Control.
2. Insert a CR-2025 Lithium battery with the positive (+) mark upward. Insert the Battery Holder into the back of the Remote Control.

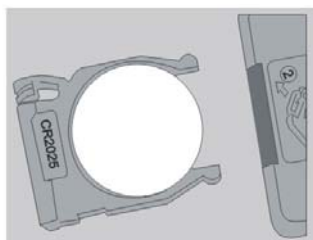
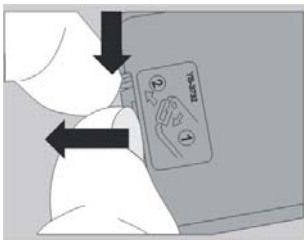

+3V  
(CR 2025)

**Warning:** Store the battery where children cannot reach. If a child accidentally swallows the battery, consult a doctor immediately.

Do not re-charge, short, disassemble or heat the battery or dispose it in fire.

Do not expose or bring into contact the battery with other metallic materials. Doing this may cause the battery to give off heat, crack or start a fire.

When throwing away or saving the battery, wrap it in tape and insulate; otherwise, the battery may give off heat, crack or start a fire.

## General Operations

### Reset the Unit

In case the unit is malfunctioned or need to reset to factory default setting, press RESET button in inner panel then the unit will be reset.

### Power on/off

Press POWER key button to turn on the unit.

Long press POWER key on front panel or press POWER button on RC to power off the unit.

Under Power on mode, short press comes in mute.

### Mode Setting

Press MODE button on front panel or remote control to change mode in a sequence of: Tuner =>DVD => USB =>Card=>TV => AV IN=> Tuner

(When USB/ Card/ DVD available.)

### Loudness

Press button on remote control to set LOUD ON/OFF.

### DISP button

Short press shows time, Long press adjust clock. Press VOL +/- adjust hours then press SEL can adjust minutes. Press DIS quit clock adjust.

### Band button

In radio mode, press to select FM1-FM2-FM3-AM1-AM2; In TV mode, press to select TV system

### Volume Control

Press VOL +/- button increase/ decrease the volume level.

### Audio Setting

Press SEL button on the Remote Control or press OK key on the front panel to select the audio setting:

VOL=>BASS =>TREBLE => BALANCE => FADER =>LOUD=> EQ=>SUB-W.

=>STEREO=>DX=>BEEP=>12H/24H=>EXIT

Press VOL +/- buttons on remote to select the audio setting item (or press the VOL +/- on front panel to select the setting item).

**Notes:** If turn off the power, all the settings of each mode will be saved.

- If you don't adjust setting within 5 seconds after selecting the desired setting item, the unit will automatically return to the current mode.

### On-Screen Display (OSD).

Press one time to show the current playing track/ played time information, long press twice to show the current playing track/ remainder time for play, long press again to clear the information.

## Digital Tuner

### Band selection

Press MODE button to select the RADIO mode.

Press the BAND button to select the desired band: FM1=> FM2 => FM3 => AM1=>AM2

### STEREO/MONO

In FM mode, press SETREO/MONO button on remote control to select stereo or mono sound reception.

### Manual/ automatic tuning

- **Manual tuning:** press the **◀◀▶▶** buttons on remote control(or on the front panel ) and hold for 2 seconds to enter the manual tuning mode. Press the **◀◀▶▶** buttons on the panel or on the Remote repeatedly to select a station downward or upward step by step.
- **Automatic tuning:** press the **◀◀▶▶** buttons on remote control(or on the front panel ), the automatic search will start. It will play when finds the station.

### Preset station 1-6 play and setting

- **Play preset station:** Short press number key 1-6 on remote control or panel to play the preset station 1-6.
- **Preset station setting:** during manual turning or automatic tuning, press and hold the number 1-6 buttons on remote or panel to store the preset station 1-6

**Remark:** You can store up to a total of 30 radio stations in the memory (18FM, 12AM).

### AS (Auto Store) / PS (Preset Scan)

**AS (Auto Store):** In tuner mode, Press the RPT/P.SCN button on the remote or panel press the AS/PS button and hold for 2 seconds to store radio station's with the best reception to the preset buttons automatically.

**PS (Preset Scan):** In tuner mode, short press this button to scan the preset memorized station, each preset scan for 5 seconds. Press again to stop operation.

## **SD/MMC Cards & USB Operations**

### USB Flash Memory

To play MP3/ MP4/ WMA files from a USB flash memory, insert a USB flash memory into the USB port on the right side of the unit. The unit will start playing MP3/MP4/ WMA files on the USB flash memory automatically. Or press the MODE button to select USB after pressing POWER button to turn on the unit.

### SD/MMC Card

To play MP3/ MP4/ WMA files on a SD/MMC card, insert the card into the card slot (you should press the OPEN button on the panel to flip down front panel and insert the card into card slot.) The unit will start playing MP3/ MP4/ WMA files on the card memory automatically. Or press the MODE button to select Card after pressing POWER Button to turn on the unit.

### PAUSE/ PLAY

Press the PLAY/ PAUSE button to pause the playback. Press the button again to resume.

### STOP

Press the STOP button on remote or on the panel to stop playback. Press the PLAY/ PAUSE button to resume. If the card or USB is removed, the resume function will be cancelled.

Press the STOP button twice to stop the playback totally. Press the PLAY/ PAUSE button to start playback from the beginning

### Selecting Tracks

If the MP3/ MP4/ WMA files are stored in the folders on the USB drive or Card, the unit will start by playing the first song in the first folder. After playing all the files sequentially in the first folder, the unit will play all the files sequentially in the next folder. The unit will continue playing through all of the folders on the USB drive or card in this manner. Press the **◀◀** button to play the previous track/chapter. Press the **▶▶** button to play the next track/chapter. Press the digital buttons (0-9) to select the desired track/chapter.

### **Select File From Folder**

When playing MP3/MP4/WMA file, press “▲” on remote control, cursor move to folder “..”, then press “Enter” to confirm selection.

Or, press “5/■” on front panel, then press “◀◀” to select folder “..”, then press “1/▶▶” to confirm selected folder.

### GOTO Function

Long press AUDIO/GOTO button on remote control to show GOTO menu, use 0-9 to input track/ time to go to directly.

### Fast Forward and Backward

Press the **◀◀/▶▶** buttons and hold for two seconds to select the fast playing in backward or forward in 2 times, press and hold for two seconds again for 4times, repeat this operation for 8 times => 16 times =>32 times => play. Press the PLAY/PAUSE button to return to normal playback.

**Note:** During the card or USB playback when Fast backward or forward gets to the beginning of the playing another track, it resumes normal playback.

## Repeat

Press the RPT button on remote control or the panel for RPT1 (repeat the current playing file) => RPT ALL (repeat all folders) => RPT folder (repeat current folder) => RPT OFF.

## Repeat A-B Function

1. Press A-B button on the remote at the starting point of the section you want to repeat (point A).
2. Press A-B button again at the ending point of the section you want to repeat (point B). Section A-B repeating starts.
3. Press A-B button again to cancel the A-B repeat function.

## Random

Press the RDM button on remote or on the panel to play all song tracks in random order.





Note: This function is only for audio files.

## Intro Playback

Press the INT button on remote or on the panel to play the beginning of every track for 10 seconds in sequence. Press again to cancel INT play.

Note: This function is only for audio files.

## Programming the Playback

1. Press PROG button on the remote open program menu.
2. Use /// buttons to select the program position and use digit 0-9 buttons to select the desired track.
3. Move the cursor to select START and press ENTER button on remote to play.
5. Press PROG again or move the cursor to select EXIT to cancel program play.





## ZOOM

Press ZOOM button and hold for 2 seconds on remote to activate zoom function in the following sequences: ZOOM 2 => ZOOM 3 => ZOOM 4 => ZOOM 1/2=>ZOOM 1/3=>ZOOM 1/4=>ZOOM OFF.

## Rotate Picture (only for picture files)

In picture mode, press / buttons to rotate picture 90 degrees.

## System Menu

In USB/ Card mode, press SETUP button on remote to show system menu. Press /// buttons to set system data, press this button again to save input data and exit system menu.

## Discs operations

### Glossary

#### **PBC (Play Back Control)**

Play Back Control is a menu recorded on the disc with SVCD or VCD2.0 format. For the discs contained PBC, it can playback interactive software with the menu displayed on TV. And if the disc contains still images, it can playback high definition of still image.

#### **Title**

The title is the important part of DVD disc. The memory volume of the disc is rather big, that makes possible to record several films on one disc. For example, if a disc contains three films, they may be divided into Title 1, Title 2 and Title 3. You can easily use the functions to search.

#### **Chapter**

A title can be divided into several blocks, so that every block can be operated as a unit, the unit is called chapter.

The chapter contains a unit at least.

### Discs for playback

- This unit can play:

DVD/SVCD/VCD/HDCD/MP3/MP4/WMA/CDDA/Picture-CD/JPEG/CD-R/-RW/DVD±R/±RW.

- The following file types are supported:

Audio files: MP3 (\*.mp3)

WMA (\*.wma)

Video files: MP4 (\*.avi, Divx3.11/ 4.0/5.0 and XVID)

MPEG 2(\*.vob)

MPEG 1(\*.dat)

Picture file: JPEG (\*.jpg)

- ISO 9660 or ISO 9660 +Joliet format - Max. 30 characters
- Max. Track number is 448
- Max. nested directory is 8 levels
- The max. album number is 99
- The max. length of each track is 99 minutes 59 seconds
- Supported sampling frequency for MP3 disc: 8 KHz to 48 (44.1 KHz preferably) KHz
- Supported bit-rates of MP3 disc are: 32 - 320 kbps (128 kbps preferably).
- Following formats are NOT supported \*.ACC, \*.DLF, \*.M3U, \*.PLS, MP3 PRO, files with DRM.
- Open session discs are NOT supported.

### **Loading a disc**

1. Turn the power on.
2. Press the Open button on the front panel to flip it down.
3. Insert the disc with the printed side facing upward into the slot. The panel will be closed automatically. The DVD mode will be turned on automatically. The monitor will show the disc content.
4. Press Open button on the panel and Eject button inner the panel to eject the disc.  
If the disc is not removed for about 10 seconds after reject, the disc will reinserted automatically.  
When disc in/out, put front panel at 0 degree to avoid distort the disc.
- 5 You may also choose the playing mode using the MODE button.

## Playing/pausing

To ensure good system performance, wait until the unit finishes reading the disc information before proceeding.

Press the PLAY/ PAUSE button to start/ pause the playback. In pause mode press it again to resume the playback.

## Stop

During playback press the STOP button on the RC or on the panel. Playback will be stopped. Press the PLAY/ PAUSE button again to start playback from the position at which it was stopped. If the disc is removed, the resume function is cancelled.

Press the STOP button twice to finally stop the playback. Press the PLAY/ PAUSE button to start playback from the very beginning

## Playing the previous/ next track/ chapter

1. During playback press the **◀◀** button to start playing the previous track/chapter.
2. Press the **▶▶** to start playing the next track/chapter.
3. Press the digital buttons (1-9, 0) buttons to enter the desired track/chapter number.

## Speed forward and backward

Long press the **◀◀/▶▶** buttons on the panel or press and hold for 2 seconds the **◀◀** or **▶▶** on the RC to select the speed of fast playing in backward or forward direction: X2, X4, X8, X16, X32. Press the PLAY/PAUSE button to return to normal playback.

**Note:** During the disc playback when Fast/ Reverse Playback gets to the beginning of the playing another track, it resumes normal playback.

## Repeat playback

Press the RPT/P.SCN button on the RC or on the panel once or more times to repeat the playback:

- For VCD/CD: display appears Repeat Track => Repeat ALL => Off (Some discs do not support this functions).
- For DVD: display appears Repeat Chapter => Repeat Title => ALL => Off
- For File disc: display appears RPT ONE => RPT ALL => RPT FOLDER => Off

## Repeat A-B function

1. During playback, press A-B button on the remote control at the starting point of the section you want to repeat (point A).
2. Press A-B button again at the ending point of the section you want to repeat (point B). Section A-B repeating starts.
3. Press A-B button again to cancel the A-B repeat function.

## Random playback (for CD/VCD/MP3 discs)

During disc playback, press the RDM button on the RC or on the panel to start random playback of the disc. Press again to cancel.

## Intro playback (for CD/VCD discs)

You can play the beginning of every track for 10 seconds in sequence. Press the INT button on remote control or on the panel to start intro play of whole disc. Press again to cancel.

## PBC (Playback Control) function (for VCD only)

If you insert a VCD with PBC, playback starts from the beginning of the 1st track automatically.

1. Long press PBC/STOP button to activate interactive menu on screen during playback.
2. If the menu consists of titles, you can select a desired one using the digit 0-9 buttons.
3. The VCD starts playing the selected title automatically or press ENTER button to confirm the selected track for playback.

## MENU function (for DVD only)

1. Press MENU button on the RC or on the panel to activate interactive DVD menu on screen during playback
2. Long press MENU button on the RC to activate interactive DVD title menu on screen during playback
3. If the menu consists of titles, you can select a desired one cursor the  $\leftarrow/\rightarrow$  or  $\uparrow/\downarrow$  buttons.
4. press ENTER button to confirm the selected track for playback.

## Programming the playback

1. Press PROG button on the RC to enter program list.
2. Use  $\uparrow, \downarrow, \leftarrow, \rightarrow$  buttons and digit buttons to enter the number of the desired track to be on selected position.  
For DVD and File disc, select title and chapter number.  
For VCD and CD, select track number.
3. Move the cursor to select START and press ENTER to play.
4. If you want to change page, move the cursor to NEXT  $\blacktriangleright\blacktriangleright$  or prev  $\blacktriangleleft\blacktriangleleft$  to change next or previous page
5. Press PROG again or move the cursor to select EXIT to cancel program play.

## Selecting different audio modes

- For DVD disc: press AUDIO on the RC repeatedly to select the audio language to listen (if the disc supports multi-language mode).
- For VCD disc: press AUDIO on the RC repeatedly to select the following modes:  
MONO LEFT  $\rightarrow$  MONO RIGHT  $\rightarrow$  MIX MONO  $\rightarrow$  STEREO  $\rightarrow$  EXIT

## Changing the subtitle language (for DVD only)

Press SUBTITLE button on the RC to select the preferred language for the disc menu. When the selected language is recorded on the disc then this language will automatically be selected. If not, the first language recorded on the disc is displayed.

## Changing size

Press and hold for 2 seconds the A-B/ZOOM on the RC. The picture will be enlarged accordingly:  
X2  $\Rightarrow$  X3  $\Rightarrow$  X4  $\Rightarrow$  X1/2  $\Rightarrow$  X1/3  $\Rightarrow$  X1/4  $\Rightarrow$  Normal.

## Changing angle (for DVD only)

If DVD discs support multi-angle playback, press ANGLE on the RC button to playback images in different camera angles. If discs doesn't support multi-angle playback, this function will not work. If no operation within 1 second, angle description will disappear.



## MP3 overview

### Notes on MP3:

- MP3 is short for MPEG Audio Layer 3 and refers to an audio compression technology standard.
- This product allows playback of MP3 files on CD-ROM, CD-R or CD-RW discs.
- The unit can read MP3 files written in the format compliant with ISO 9660. However it does not support the MP3 data written by the method of packet write.
- The unit can not read an MP3 file that has a file extension other than “.mp3”.
- If you play a non- MP3 file that has the “.mp3” extension, you may hear some noise.
- In this manual, we refer to what are called “MP3 file” and “folder” in PC terminology as “track” and “album”, respectively.
- Maximum number of directory level is 8, including the root directory. Maximum number of files and folders per disc is 448.
- The unit may not play tracks in the order of Track numbers.
- The unit plays only the audio tracks if a disc contains both audio tracks and MP3 files.
- When playing a disc of 8 kbps or “VBR”, the elapsed playing time in the display window will not be correct and also the intro play may not function properly. “VBR”: Variable Bit Rate.

### Notes on creating your own CD-R or CD-RW containing MP3 files:

- To enjoy high quality sound, we recommend converting to MP3 files with a sampling frequency of 44.1 kHz and a fixed bit rate of 128 kbps.
- DO NOT store more than 448 MP3 files per disc.
- For ISO 9660 - compliant format, the maximum allowable depth of nested folders is 8, including the root directory (folder).
- When CD-R disc is used, playback is possible only for discs, which have been finalized.
- Make sure that when MP3 CD-R or CD-RW is burned that it is formatted as a data disc and NOT as an audio disc.
- You should not write non-MP3 files or unneeded folders along with MP3 files on the disc otherwise it takes a long time until the unit starts to play MP3 files.
- With some CD-R or CD-RW media, data may not be properly written depending on its manufacturing quality. In this case, data may not be reproduced correctly. High quality CD-R or CD-RW disc is recommended.
- Up to 16 characters are displayed for the name of an Album or a Track. ID3TAG version 1.x is required.
- Note that the unit may not play Tracks in the order that you wrote them to the disc.

### 1. Audio files:

MP3, WMA

### 2. Video files:

MPEG4 TM1 3.11, 4X, 5X and 6X versions

Nero Digital TM2

Real time MPEG2 MP@ML display

Real time MPEG1 D1 (720X480X30/ 720X576X25) decoding

## Setup Menu

- Press SETUP button to enter the system settings main menu;
- Press cursor / buttons to move along icons on the top navigation bar on settings main menu. Select one of the setup pages: General, Speaker, Downmix, Audio;
- Press cursor / buttons to choose a setting or return to the Setup Page;
- Press cursor button to enter the highlighted setting;
- Press ENTER button on remote contro confirm your setting.

### General settings

 -- GENERAL SETUP PAGE --	Menu entry	Function
TV DISPLAY      PS	TV Display	Here you can adjust the output format for the DVD playback according to your preferences.
ANGLE MARK      ON	Angle Mark	This function is indicated in the device menu but not supported by the device.
OSD LANG          ENG	OSD language	This menu item allows you to set the language of this menu.
CAPTIONS          OFF	Captions	This function displays subtitles as long as those are available on the data carrier and the function is activated.
SCREEN SAVER    ON	Screen Saver	Chose ON or OFF about last memory ,chose ON ,turn off the sreen the memory will be save,chose OFF turn on the unit will be back to the default setting .
GO TO GENERAL SETUP PAGE		

### Speaker settings

 -- SPEAKER SETUP PAGE --	Menu entry	Function
DOWNMIX	Downmix	Here you can set the format in which the DVD sound should be played back. STEREO = analog stereo signal RIGHT / LEFT = Dolby Pro Logic stereo signal (2 channel sound) SURROUND = Virtual surround sound If STEREO has been switched on, "STR" will appear, for RIGHT / LEFT, "LTRT" will appear, and for SURROUND, "VSR".
GO TO SPEAKER SETUP PAGE		

## Dolby settings

	<p><b>Menu entry</b></p>	
	<p><b>Dual mono</b></p>	<p>With this menu item you can select the type of Left and Right channel audio output. Stereo is normal Stereo, Mono L is all sound on the Left Audio output, Mono R is all sound on the Right channel. The “Mix Mono” function only works when a DVD is being played in DTS 5.1 mode.</p>

## Video settings

	<p><b>Menu entry</b></p>	
	<p><b>Sharpness</b></p>	<p>This serves to set the sharpness of the image (high / medium / low).</p>
	<p><b>Brightness</b></p>	<p>This serves to set the brightness of the image (- 20 to + 20).</p>
	<p><b>Contrast</b></p>	<p>This serves to set the contrast of the image (- 10 to +20)</p>

## Preference settings

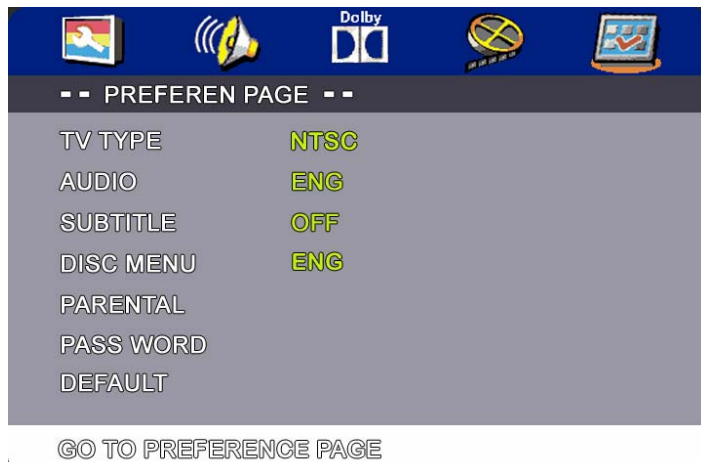

Menu entry	Function	
TV Type	This setting enables the selection of the appropriate TV standard. PAL is the customary standard in Europe. NTSC is the customary standard in the US and Japan. Only select the MULTI option if your TV can play back both formats. Here the output signal is automatically adjusted to the standard of the inserted DVD. If the "MULTI" setting is selected, "AUTO" will be displayed to the left of the selection menu.	
Audio	This enables the selection of the desired dubbed language. If the language selected here is not available on the inserted data carrier, the first language that is found will be played back.	
Subtitle	This enables the selection of the desired subtitles. If the subtitles selected here are not available on the inserted data carrier, the first subtitles that are found will be played back.	
Disc Menu	This enables the selection of the desired menu language. If the language selected here is not available on the inserted data carrier, the first language that is found will be played back	
Parental	<p>This serves to set the desired age rating.</p> <ol style="list-style-type: none"> <li>1) Child = Kid safe</li> <li>2) G = some guidance advisable</li> <li>3) PG = Parental guidance suggested, some material may not be suitable for children</li> <li>4) PG 13 = Parents strongly cautioned, some material may be inappropriate for children under 13</li> <li>5) PGR = Restricted, under 17 requires accompanying parent or adult guardian</li> <li>6) R = Restricted viewing</li> <li>7) NC17 = No one 17 and under admitted</li> <li>8) 18 or older = for Adult Entertainment or X rated movies and NO PARRENTAL is for General Audiences (All Ages).</li> </ol>	<p>After setting the age rating, you will be prompted to enter a password. The factory default password is set to <b>1369</b>. Enter this through the number buttons on the remote control. Now select "YES" or "NO" with the arrow buttons. Then confirm your selection with the "ENTER" button.</p>
Password	This function serves to protect the selected settings. The factory default password is <b>1369</b> .	
Default	This function resets the DVD device settings to the factory default settings.	



**Note:** If you have forgotten your changed password, you can set a new one at any time by entering the factory default password **1369**..

### **Factory default settings (“RESET“)**

By using the reset function, the device can be changed back to the factory default settings. To use the reset function, please press the button REL on the device. Now the operating unit can be carefully detached towards the front and left. Now press the RESET button on the device with a thin, sharp object. The device will then be reset and turned off if required.

**Note:**

When the factory settings are restored, the clock and the stored radio stations will also be reset

## **TV OPERATIONS** (TV function is for DVD-22T only)

Connect TV antenna as it is shown on electrical connection diagram.

### **Switch to TV mode**

Press MODE button repeatedly to select the TV mode, and press BAND select TV system: PAL DK → PAL I → PAL BG → PAL M → PAL N → SCEAM DK → SCEAM BG → NTSC M

### **Auto tuning**

1. Press **◀◀ / ▶▶** cursor buttons on RC or **|◀◀ / ▶▶|** buttons on panel or touchable screen to start auto search of available TV station in backward/forward direction. When the first available station is found searching will be stopped and the station found will be played. Press these buttons again to continue searching.

### **Manual tuning**

Press and hold for 2 seconds **◀◀ / ▶▶** cursor buttons on RC or **|◀◀ / ▶▶|** buttons on panel or touchable screen repeatedly to search the TV stations step by step.

### **Auto preset memory**

1. Press RPT/P.SCAN button on the RC or Press AS/PS button on panel to start auto tuning; the search range is the current TV frequency range. The stations found will be stored into the memory automatically.
2. Press this button again to stop auto searching.

### **Select the TV station**

1. Press number buttons on the RC 0-9 to recall the desired TV station.
2. Press number button on front panel 1-6 to recall the desired TV station.



## **Other Functions**

### **Subwoofer**

Connect the subwoofer to the unit using sub output (see electrical diagram). Press SEL button, choose expert and set subwoofer ON to enable subwoofer.

## **Anti-theft system**

### Remove the panel

1. Press the PWR button to turn the power off.
2. Press OPEN button to detach the panel.
3. Pull the panel out.
4. Place the panel into the case and take it with you when you leave the car.

### Remove the unit

1. Remove the panel and the trim plate.
2. Insert both T-Keys into hole on the front of the set until they lock.
3. Pull out the unit.

## Note on Discs

- ✧ Only use groundless loudspeakers.
- ✧ Use only loudspeakers of minimal 40 Watt, using fewer watts may result in damaging your loud speakers at higher volumes.
- ✧ Use 4~8  $\Omega$  (Ohm impedance) loudspeakers only; using higher or lesser impedance may damage the unit.
- ✧ Do not use 3-cable loudspeakers and do not connect the loudspeakers minus to the car body.
- ✧ (GND). using a BTL circuit and each loudspeaker must be connected with insulated cables according the diagram.
- ✧ Loudspeaker cables and/or optional external power amplifiers must always be about 30cm. away from the antenna and/or antenna extension parts.

### Handling discs

#### Handling

When holding  
With both hands

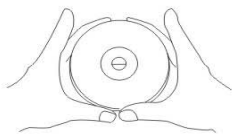

When holding  
with one hand



- Do not use damaged (cracked or warped) discs.
- Do not scratch the signal surface or let it get dirty.
- Do not attach paper or seals to discs. The player may be damaged if there is any exposed glue, etc., On discs. For rental discs in particular, extra labels are often attached to the discs. Check carefully for any exposed glue before using such discs.

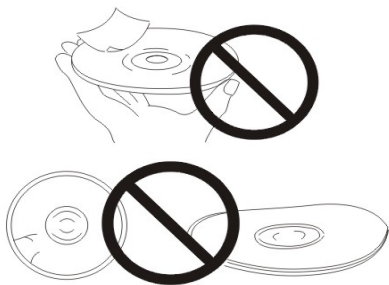

#### Storing discs

- Always place discs in their case and store them vertically. Avoid storing discs in hot or humid places, places exposed to direct sunlight and places in which the temperature is extremely low.
- Read any cautions included with the discs carefully.

#### Cleaning discs

- Fingerprints or dust on discs may reduce sound or picture quality. Remove them by gently wiping the disc from the center toward the edges using a soft cloth.

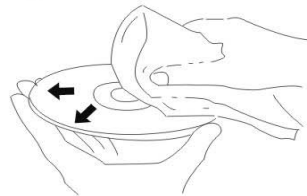

- Do not use benzene, thinner or other volatile chemicals. Do not use record spray or antistatic spray either.
- We recommend using the separately sold cleaning set to clean discs.
- For tough dirt, apply some water to a soft cloth, wring out thoroughly, wipe off the dirt, then wipe the disc with a dry cloth.

Irregular shaped discs  
Irregular shaped discs (heart-shaped discs, hexagonal discs, etc.) cannot be played on this player. Doing so could damage the player. Never use such discs.



## Troubleshooting guide

Symptom	Cause	Solution
General No power	The car ignition is not on. The fuse is blown.	If the power supply is properly connected to the car accessory switch the ignition key to "ACC". Replace the fuse.
Disc Disc cannot be loaded.	Presence of disc inside the player	Remove the disc in the player then put a new upward.
Disc cannot be read.	Inserting the disc in upside down. Compact disc is extremely dirty or defective. Temperature inside the car is too high.	Insert the compact disc with the label facing upward. Clean the disc or try to play a new one. Cool off until the ambient temperature returns to normal.
No sound	Volume is in minimum. Wiring is not properly connected.	Adjust volume to a desired level. Check wiring connection.
The operation keys do not work.	The built-in microcomputer is not operating properly due to noise. Front panel is not properly fix into its place.	Press the RESET button. Reinstall the front panel.
Sound skips.	The installation angle is more than 30 degrees. The disc is extremely dirty or defective.	Adjust the installation angle to less than 30 degrees. Clean the compact disc/try to play a new one.
The radio does not work, the radio station automatic selection does not work.	The antenna cable is not connected the signals are too weak.	Insert the antenna cable firmly select a station manually.



## Specification

General	
Power supply:	12 V DC
Current consumption:	max. 10 A
Maximum power output:	40W x 4 channels
Compatible formats:	DVD/SVCD/VCD/HDCD/MP3/MP4/WMA/CDDA/Picture-CD/JPEG/CD-R/ -RW/DVD±R/±RW playback
Dimensions (W x D x H) / weight:	178 x 175 x 50 mm / 1.8 kg
ESP function:	40 sec. for Audio CD, 120 sec. for MP3
Working temperature range:	-10°C - +60°C
FM Stereo Radio	
Frequency range:	87.5 – 107.9 MHz
Usable sensitivity:	≤15dB
Preset memory stations:	18
AM section	
Frequency range:	530 kHz - 1710 kHz
Preset memory stations:	12
Audio specification	
Maximum output:	10 Vrms (+/- 3 dB)
Frequency response:	20 Hz - 20 KHz
S/N ratio(A-vtd):	68 dB
DSP sound effect:	Classic, Rock, Pop, Flat and none
Line out	4 channel RCA line-out 1 channel Subwoofer pre-out

**Specifications are subject to change without notice. Mass and dimension are approximate.**

Manual version: March 2010

## Free Manuals Download Website

<http://myh66.com>

<http://usermanuals.us>

<http://www.somanuals.com>

<http://www.4manuals.cc>

<http://www.manual-lib.com>

<http://www.404manual.com>

<http://www.luxmanual.com>

<http://aubethermostatmanual.com>

Golf course search by state

<http://golfingnear.com>

Email search by domain

<http://emailbydomain.com>

Auto manuals search

<http://auto.somanuals.com>

TV manuals search

<http://tv.somanuals.com>