

Fahrenheit

Class X

Owner's manual

Fahrenheit Series

CLX260-2 CLX340-2 CLX470-2 CLX620-2 CLX760-2 CLX940-2
CLX520-4 CLX730-4



TABLE OF CONTENTS

INTRODUCTION

SPECIFICATION

END PANEL LAYOUT

INPUT CONFIGURATIONS

INPUT GAIN

AUXILIARY OUTPUT CONFIGURATIONS

CROSSOVER SECTION CONFIGURATIONS

POWER CONNECTIONS: **CLX260-2, CLX340-2, CLX470-2,**
CLX620-2, CLX760-2, CLX940-2,

POWER CONNECTIONS: **CLX520-4, CLX730-4**

SPEAKER CONNECTIONS

INSTALLATION TIPS

AUTOSOUND 2001 TROUBLESHOOTING TIPS

INTRODUCTION

Thanks for your purchase of Fahrenheit Class X power amplifier.

Each class X amplifier is designed to be the leader in its class offering the most power, advanced features and extreme ease of use.

In high-end sound systems or high SPL systems, the Class X amplifiers will give you years of trouble-free performance.

*CLX260-2/CLX340-2/CLX470-2 2channel Amplifier with built in fully variable high-Pass, low-pass with subsonic filter.

All these models are capable of 3, 2 or 1 channel operation with maximum power capability

*CLX620-2/CLX760-2/CLX940-2 high power 2channel amplifier with built in fully variable high-pass, low pass with subsonic filter

All these models are capable.

*CLX520-4/CLX730-4 4channel high power amplifier with built in fully variable high-pass, low-pass with dual subsonic filter

All these models are capable of 5, 4 or 2channel operation with a maximum power capability.

Installation of all Fahrenheit component will determine the overall performance result.

Importer installation will not only limit the performance of your Fahrenheit system but also potentially compromise the reliability of the amplifier

To ensure proper sonic results and component reliability, please refer to your authorized Fahrenheit dealer for installation assistance or advice.

If you decide to perform the installation yourself, read the entire installation section of this manual before beginning the installation

ABOUT THE MANUAL

This manual is designed to answer your questions about this products.

In the event you have question not covered in this manual, please refer question to your Authorized Farenheit Dealer.

Additionally, you can call Farenheit Technology Support Hotline atfor assiataance.

PRACTICE SAFE SOUND

Continuous exposure to sound pressure levels over 100dB may cause permanent hearing loss.

High powered automotive sound systems can generate sound pressure levels in excess 130dB.

When playing your system at high levels, please se hearing protection and prvent long term exposure.

RECORDED YOUR SERIAL NUMBER AND DATE !PLEASE KEEP THE PURCHASE RECEIPT

MODEL# :

SERIAL NUMBER :

DATE OF PURCHASE :

Company Purchased From :

WHAT'S IN THE BOX

DESCRIPTION

	QTY
CLASS X Power Amplifier	1
Installation Screws	4
CLASS X Reference Manual	1
Warranty Card	1

Refer to specification

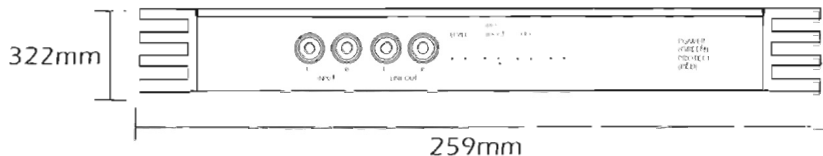
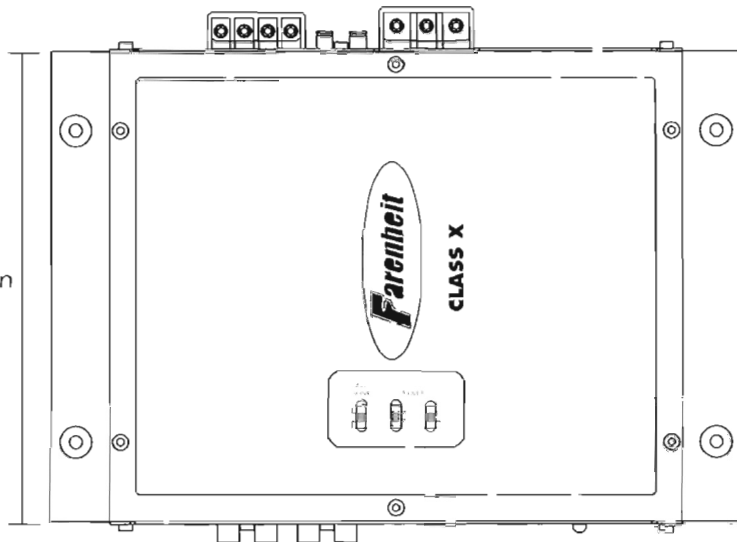

SPECIFICATIONS

AMPLIFIER	CLX260-2	CLX340-2	CLX470-2	CLX620-2	CLX760-2	CLX940-2	CLX520-4	CLX730-4
Power output max	380W	480W	740W	1000W	1100W	1400W	720W	960W
Power output 4ohm	60WX2	75WX2	120WX2	155WX2	175WX2	220WX2	60WX4	75WX4
Power output 2ohm	95WX2	120WX2	185WX2	250WX2	280WX2	340WX2	90WX4	120WX4
Power output bridged	190W	240W	370W	500W	560	700W	180WX2	240WX2
Distortion all channel driven	<0.02%	<0.02%	<0.02%	<0.02%	<0.02%	<0.02%	<0.02%	<0.02%
Frequency Response Linear Bandwidth	20HZ TO 30K HZ +,- 0.5dB							
Signal to Noise Ratio full band width @ rated power	>100dB	>100dB	>100dB	>100dB	>100dB	>100dB	>100dB	>100dB
Damping factor @ ouput connector full band width	>200 at output connector							
Input Level	200mV to 6V							
Input Impedence	10K ohm							
fuse type	10Ax2	10Ax2	20Ax2	25Ax2	30Ax2	30Ax2	20Ax2	25Ax2
CROSSOVER	CLX260-2	CLX340-2	CLX470-2	CLX620-2	CLX760-2	CLX940-2	CLX520-4	CLX730-4
low-pass crossover				Continuous Variable				
low-pass frequency range				From 50Hz to 5K Hz				
high-pass crossover				Continuous Variable				
high-pass frequency range				From 50Hz to 5K Hz				
Subsonic filter				27Hz				
Dimension(259WX32HXD)mm	180mm	200mm	250mm	300mm	360mm	400mm	300mm	360mm

1. All channels driven, continuous 4ohm load, 20Hz to 20,000Hz, <0.1% THD, power in/out voltage at 13.2VDC

2. All channel driven continuous 2ohm load, 20Hz to 20,000Hz, <0.1% THD, power in/out voltage at 13.2VDC

3. Crossover with a slope rate of 18dB/Octave

INTERNAL CROSSOVER CONFIGURATION

HIGH-PASS

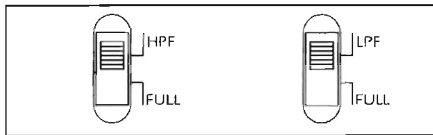

LOW-PASS

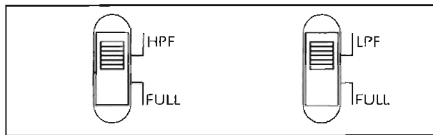

The crossover section of CLASS X amplifier is continuously variable and extremely flexible.

When using loudspeakers, minor deviations from the recommended frequency ranges can provide superior results depending on your speaker locations and your vehicle acoustics. Setting crossover frequencies higher than recommended will not cause damage and may provide superior sonic results depending on your system's performance goals.

LOW-PASS CROSSOVER

LOW-PASS

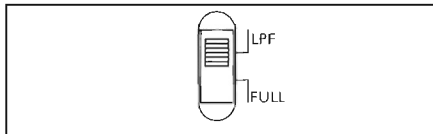

When the switch is in the "FULL" position, the low-pass crossover is bypassed

LOW-PASS

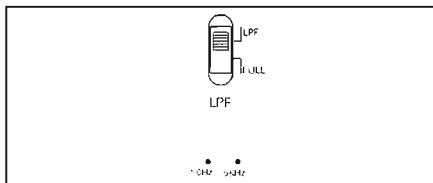

When the switch is in the position "LPF" the low-pass crossover is active. the low-pass crossover is continuously variable from 50Hz to 5KHz

HIGH-PASS CROSSOVER

HIGH-PASS

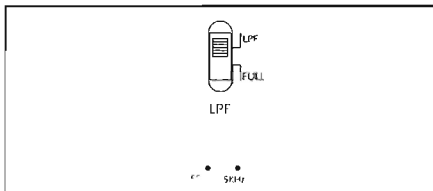

When the switch is in the position "HPF" The High-Pass crossover is Active. The High-Pass crossover is Continuously variable from 50Hz to 5KHz.

END PANEL LAYOUT

1. Power LED-when lit indicates that the amplifier is on.
2. Independent Gain control-continuously adjust from 200mV to 6Vrms for full power output
3. RCA inputs-accepts RCA input from a source unit, preamplifier or equalizer
4. AUX RCA output control-determines the audio signal out the AUX RCAs
5. Low pass Frequency Contro-adjusts the frequency of the low-pass crossover
6. Low-Pass Crossover activation switch-activates the low-pass crossover.
7. High pass frequency control-adjusts the frequency of the high-pass crossover.
8. High-pass Crossover activation switch-activates the high pass crossover
9. REM remote turn-on input-turns on the amplifier when fed 12V+
10. Speaker Connections-allows up to 12 gauge speaker wire
11. Fuses-protects the amplifier from over current situations
12. Power connection-allows up to 4 gauge power & ground cables.
13. Bass Boost adjust control-adjust bass of the low-pass crossover
14. Subsonic adjust control-adjust subsonic filter.

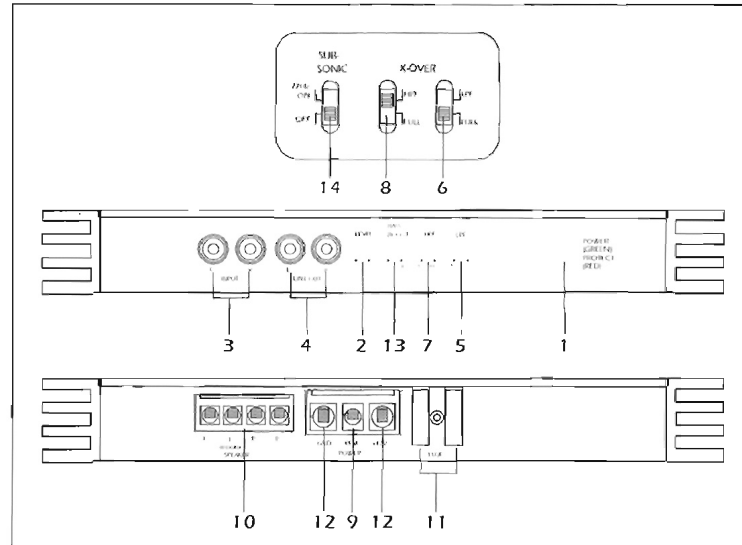

INPUT Gain Control

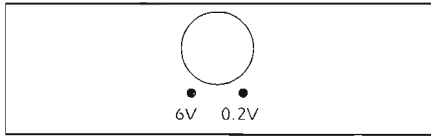

The input sensitivity of these adjustments range from 200mV up to 6Vrms to easily intergrate with any source both units after market and OEM.
Refer to the testing the system & the adjusting thhe sound of the system fr detailed instructions on setting gain.

AUXILIARY OUTPUT

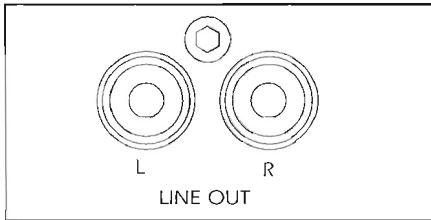

The Auxiliary outputs offer CLASS X amplifiers easy, unlimited system expansion.
Routing signal from a source unit, pre-amplifier or equalizer is a matter of routing RCAs into the RCA inputs and out the AUX outputs to the next CLASS X

POWER CONNECTIONS

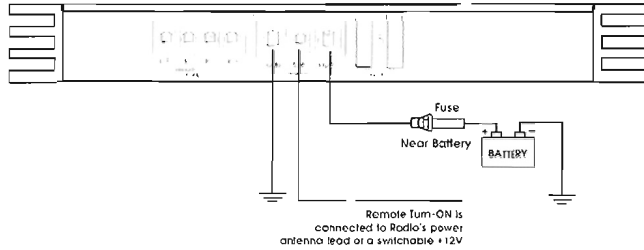

2CHANNEL MODEL:

CLX260-2, CLX340-2, CLX470-2, CLX620-2, CLX760-2, CLX940-2

FUSE SIZE

Refer to specification for the correct fuse size

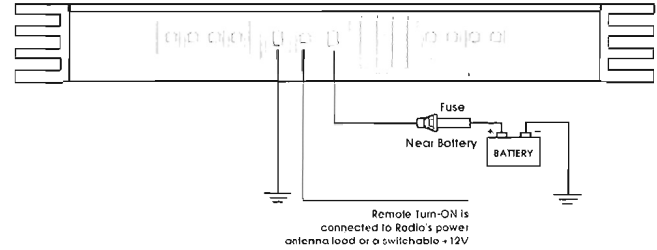

4CHANNEL MODEL:

CLX520-4, CLX730-4

*Power connections made through a large 4 gauge removable terminal connector.

*4 gauge power and ground wire recommended for optimal performance.

*Minimum 8 gauge power and ground cable is recommended for acceptable performance.

*Connect 12V+ to the battery through fuse holder. This connection provides +12V main power to the amplifier.

*Power wire must be fused less than 18" from battery.

*Ground amplifier to a good chassis ground as close as possible to the amplifier.

*Connect REM terminal to remote turn-on lead from source unit. This connection provides +12V power to turn-on the amplifier.

*Add Extra Ground wire between the negative terminal of the battery and the chassis.

NOT: The addition of a ground wire from the battery to the chassis of the vehicle improves the ability of the battery to supply power to the amplifier. This helps especially in newer vehicles, where the current delivery of the factory electrical system was designed only to accommodate electronics supplied by the auto manufacturer.

TWO CHANNEL STEREO CONFIGURATION FOR CLX260-2, CLX340-2, CLX470-2, CLX620-2, CLX760-2, CLX940-2

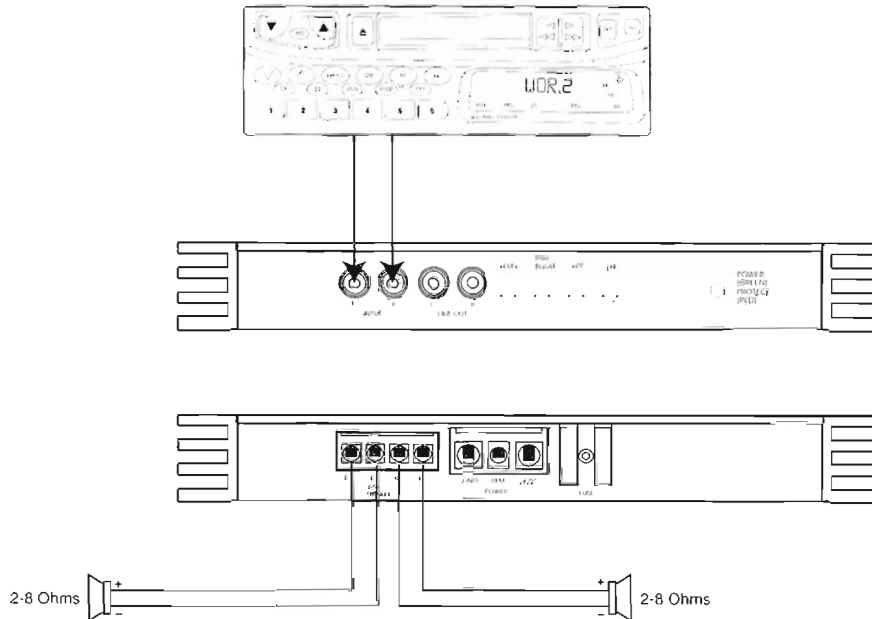

- *Lowest Recommended Impedance is 4ohm Stereo
- *RCA Inputs are connected to both Left and Right channels
- *Gain controls can be set together or independently of each other
- *Output can be configured for high-pass, low-pass or full range operation
- *Output configured for stereo operation

SUMMED BRIDGED CONFIGURATION FOR CLX260-2, CLX340-2, CLX470-2, CLX620-2, CLX760-2, CLX940-2

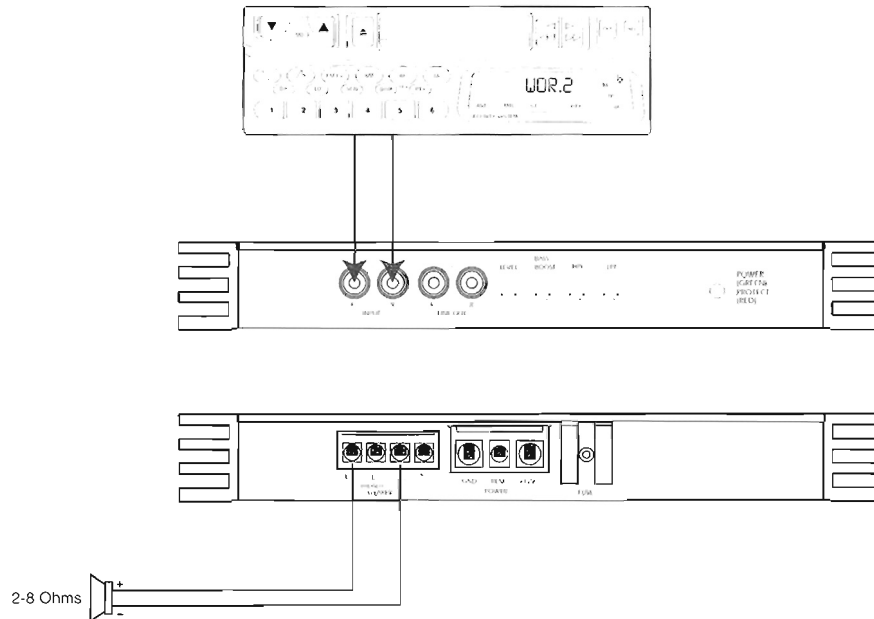

*Lowest recommended impedance is 4ohm bridged mono

*RCA Inputs are connected to both left & right channels

*Output is configured summed bridged which is ideal for subwoofer applications

TRI-MODE THREE CHANNEL CONFIGURATION FOR CLX260-2, CLX340-2, CLX470-2, CLX620-2, CLX760-2, CLX940-2

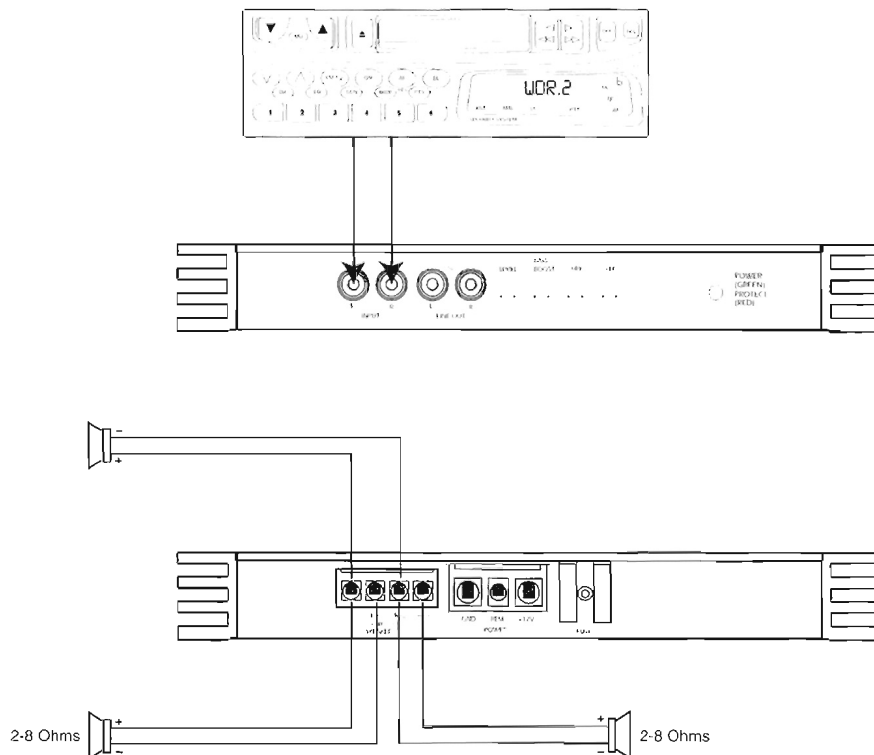

FOUR CHANNEL STEREO CONFIGURATION FOR CLX520-4, CLX730-4

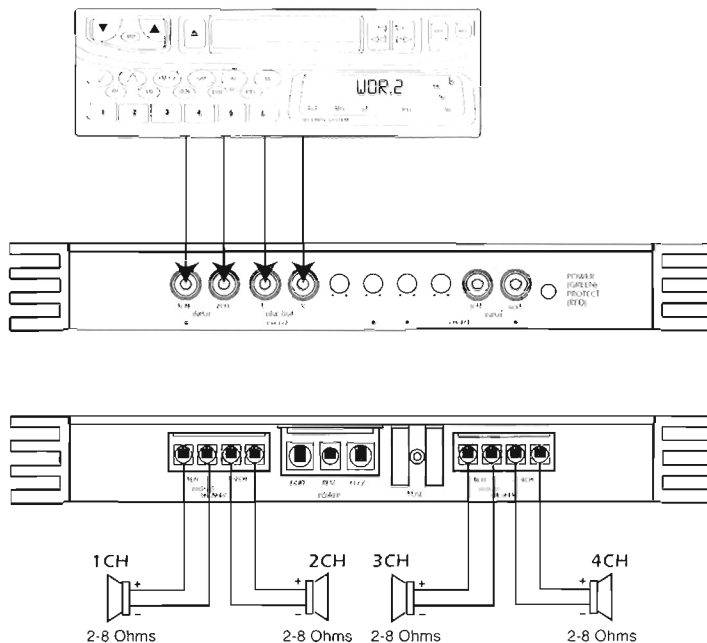

- *Lowest Recommended Impedance is 4ohm Stereo
- *RCA Inputs are connected to both Left and Right channels
- *Gain controls can be set together or independently of each other
- *Output can be configured for high-pass, low-pass or full range operation
- *Output configured for stereo operation

TWO CHANNEL CONFIGURATION FOR CLX520-4, CLX730-4

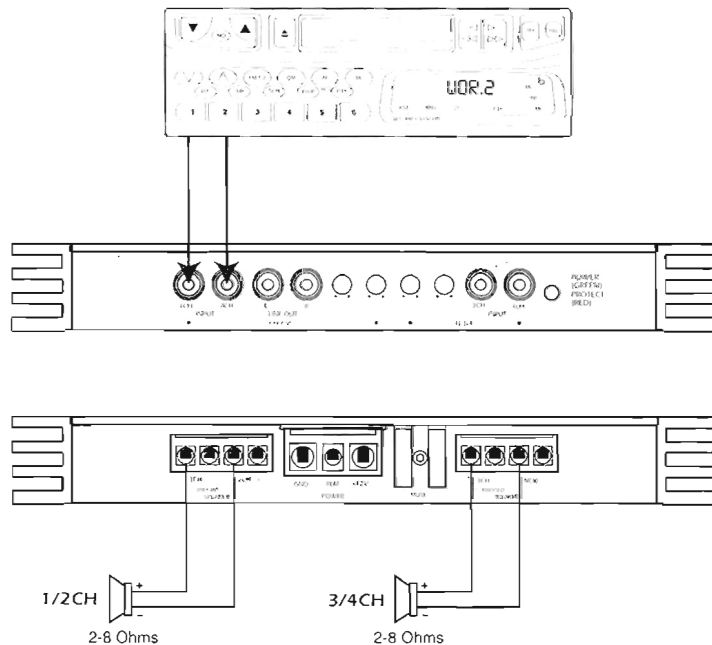

*Lowest recommended impedance is 4ohm bridged mono

*RCA Inputs are connected to both left & right channels

*Output is configured summed bridged which is ideal for subwoofer applications

SIX CHANNEL CONFIGURATION FOR CLX520-4, CLX730-4

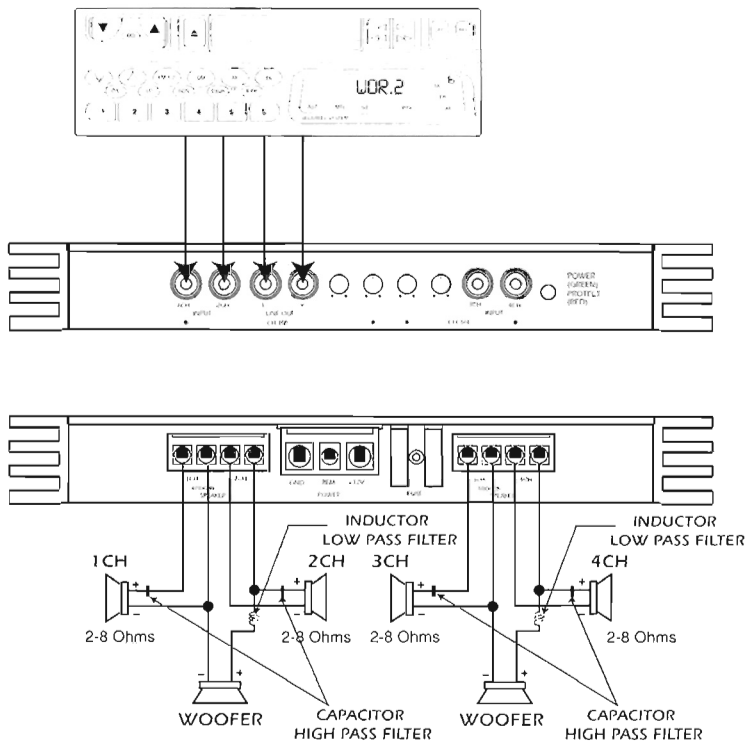

CHOOSING MOUNTING LOCATIONS

The location of your CLASS X amplifier will depend on several important issues. Due to the low profile size of the CLASS X amplifiers, there are many possible installation locations that will yield satisfactory amplifier performance. Always mount the amplifier in a place that protects the amplifier from the elements. In addition, mount the amplifier on a stable, flat mounting surface. As with any amplifier, there are several possible mounting locations and configurations that can be optimal. We will cover the most obvious of situations.

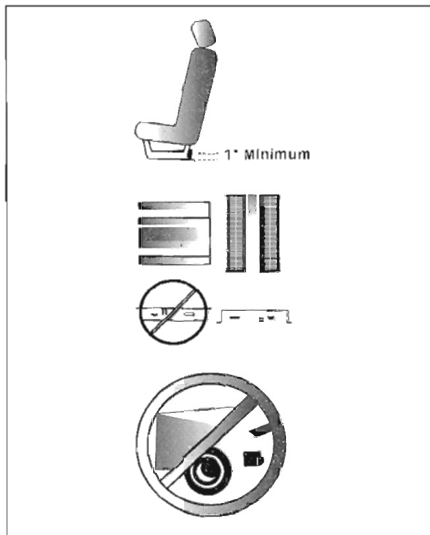

PASSENGER COMPARTMENT MOUNTING

If you are going to mount the amplifier in the passenger compartment, make sure you have adequate room for ventilation. The CLASS X amplifiers have been designed to make possible under seat mounting. When mounting your amplifier under a seat or similar area, keep a minimum of 1" of clearance around the amplifier for adequate cooling.

TRUNK COMPARTMENT MOUNTING

Mounting the CLASS X amplifier in the trunk provides excellent performance as long as you do not mount the amplifier upside down or restrict the airflow around the heatsink of the amplifier. For optimal results, mount the amplifier with the cooling fins in the vertical position. This type of mounting will yield the best cooling due to the convection effect of the amplifier chassis.

ENGINE COMPARTMENT MOUNTING

Do not mount the CLASS X amplifier in the engine compartment. The amplifier was not designed to endure the harsh environment of the elements.

GENERAL PRECAUTIONS AND INSTALLATION TIPS

Caution: Be careful not to cut or drill into gas tanks, fuel lines, brake lines, hydraulic lines, vacuum lines, or electrical wiring when working on your vehicle.

Disconnect the vehicle's ground wire at the battery before making or breaking connections to the audio system's power supply terminals.

Do not use the CLASS X amplifier unmounted. Failing to securely mount the amplifier can result in damage or injury, particularly in the event of an accident. An unmounted amplifier acts like a heat-seeking missile in the event of a crash. Never mount a CLASS X amplifier where it might get wet. Mount the CLASS X amplifier so the wire connections will not be pulled. Route the wires where they will not be scraped, pinched or damaged in any fashion.

The +12V power supply wire must be fused as close as possible to the battery terminal, ideally within 18". Use the recommended fuse size or circuit breaker listed in the POWER CONNECTIONS section of this manual.

If you need to replace the fuse plugged into the side of the CLASS X amplifier, replace the fuse with the same size ATC type fuse that came with the amplifier. If you are not sure as to the correct value refer to the POWER CONNECTIONS section of this manual for details. Using a higher current fuse may result in damage to the CLASS X amplifier which is not covered under warranty.

NOTE: Make sure all the equipment in the system is turned off when making or breaking connections to the CLASS X input RCAs or speaker terminals. Turn on the system and slowly turn up the CLASS X amplifier which is not covered under warranty.

Power for systems with a single CLASS X amplifier can be supplied by most any automotive electrical system. Systems with multiple amplifiers may require a higher capacity battery, alternator or the use of a storage capacitor. We strongly recommend the use of both a transient storage capacitor and extra battery in larger stereo systems.

CLASS X amplifiers generate a certain amount of heat as part of their normal operation. Be sure the area around the cooling fins is unobstructed to allow adequate air circulation. Remember, beach blankets, last week's laundry, school books and homework papers located on top of the amplifier does not improve air flow

STEP BY STEP INSTALLATION

- Step 1** Determine the location for the amplifier. Refer to the Mounting Locations section in this manual for detailed information.
- Step 2** Decide on the system configuration for your amplifier. For system suggestions, refer to the System Planning section of this manual.
- Step 3** Run all the wires from the amplifier location to the speakers, source unit and battery. Do not connect the battery at this time. Be sure to run RCAs, power and speaker wires away from factory electrical wires and system as they pose a great potential for induced system noise.
- Step 4** Pre-drill amplifier mounting holes. Be sure to "thank before you drill". Gas tanks, fuel lines, and other obstructions have a nasty way of hiding themselves. For best results use a marking pen to mark the mounting holes and pre-drill these holes with a standard 1/8" drill bit.
- Step 5** Mount the amplifier. Make sure the amplifier is mounted on a flat surface. If this is not possible, do not over tighten the screws such that the chassis of the amplifier is twisted or bent.
- Step 6** Turn the vehicle's key switch to the off position.
- Step 7** Disconnect the vehicle's battery ground terminal.
- Step 8** Connect the RCA and speaker wires to the amplifier. Check the quality of your speakers and signal connections. This will determine the ultimate performance of your CLASS X amplifier. Refer to the Installation Quick Reference section of this manual for correct wiring instructions.
- Step 9** Connect power wires to the amplifier. At this time do not connect the fuse at the main battery.
- Step 10** Reconnect the ground terminal to the battery.
- Step 11** Set crossover and signal routing configurations. Refer to the "Input Configurations" and the "Internal Crossover Configuration" sections of this manual for detailed instructions.
- Step 12** Once satisfied that all connections and settings are correct, install fuse at location near the vehicle's battery and proceed to the "Testing the System" section of this manual.

WARNING!!! Never exceed the recommended fuse size of this amplifier. Failure to do so will result in voiding of your warranty

TESTING THE SYSTEM

After you have completed the installation, you need to test the system. This will help ensure years of trouble free operation. Please refer to the listed steps below when testing the sound of CLASS X system.

- Step 1 Check all the wiring connections to be sure they are correct and secure.
- Step 2 Turn the signal source volume control down all the way. Set any tone controls to their flat or defeated positions. This includes the loudness control.
- Step 3 Turn the level controls of the amplifier to their minimum positions.
- Step 4 Turn the source unit on. Check to see if the remote power LED located on the connection side of the amplifier is on. If not, please refer to the "Power Connections" section and the "Trouble Shooting" section of this manual for instruction.
- Step 5 If using an aftermarket source unit, turn the level controls of the amplifier about one quarter of a turn. Slowly increase the volume level of the source unit to so that you can hear the output of the system. If sound is heard or if the output is distorted, turn the system off immediately. Refer to the "Power Connections" section and the "Trouble shooting" section of this manual to solve your installation problems.
- Step 6 Check to make sure the output for each channel is correct. If the active crossovers are used, check to make sure that each output is correct from the amplifier. When using active crossovers on midrange and tweeters, do not use crossover frequencies lower than recommended. If the system is not configured properly, refer to the internal crossover section of this manual and take corrective action.
- Step 7 If the output is clear and undistorted, continue to the "Adjusting the Sound of the System" section of this manual.

ADJUSTING THE SOUND OF THE SYSTEM

Once you have checked the system's operation, adjust the sound of the system. Adjusting the sound of the system is accomplished by setting the level controls and adjusting the internal crossovers.

- Step 1** Turn the signal source volume control down all the way. Set any tone controls to their flat or defeated positions. This includes the loudness control.
- Step 2** Turn the level controls of the amplifier to their minimum positions.
- Step 3** Choose music with high dynamic content that you like, that you are familiar with and will be most often used in the system.
- Step 4** Turn the unit up to its highest undistorted output level. If you lack test equipment, this point occurs between 3/4 to full volume depending on the quality of your source unit. Listen for any audible distortion. If any distortion is audible, reduce the volume of the source unit until you have an undistorted output. Leave the volume control at this position during your system tuning.
- Step 5** While listening to your chosen dynamic music, turn up the level control corresponding to the midrange output until you hear slight distortion and turn back the level control slightly for an undistorted output. Depending on your system, the midrange and tweeter output may be on the same output channels.
- Step 6** Turn up the level control corresponding to the tweeter output until you hear slight distortion and turn back the level control slightly for an undistorted output. Depending on your system the midrange and tweeter output may be on the same output channels.
- Step 7** Fine tune the crossover setting and output level between the midrange and tweeters. Refer to the "Internal Cross over Configuration" section of this manual for detailed instructions.
- Step 8** Repeat Steps 5-7 for the rear speakers. If you do not have rear speakers continue to Step 10.
- Step 9** Set levels between the midrange and tweeters for optimum front/rear balance.
- Step 10** Turn up the level control corresponding to the woofer output until you hear slight distortion and turn back the level control slightly for an undistorted output.
- Step 11** Fine tune the crossover setting and output levels between satellite speakers and the woofers. Refer to the internal crossover configuration section of this manual for detailed instructions. If using an RGC-1, adjust the level to match the output of the woofer to match the sonic requirements of the system.

ADJUSTING THE SOUND OF THE SYSTEM

Once you have checked the system's operation, adjust the sound of the system. Adjusting the sound of the system is accomplished by setting the level controls and adjusting the internal crossovers.

- Step 1** Turn the signal source volume control down all the way. Set any tone controls to their flat or defeated positions. This includes the loudness control.
- Step 2** Turn the level controls of the amplifier to their minimum positions.
- Step 3** Choose music with high dynamic content that you like, that you are familiar with and will be most often used in the system.
- Step 4** Turn the unit up to its highest undistorted output level. If you lack test equipment, this point occurs between 3/4 to full volume depending on the quality of your source unit. Listen for any audible distortion. If any distortion is audible, reduce the volume of the source unit until you have an undistorted output. Leave the volume control at this position during your system tuning.
- Step 5** While listening to your chosen dynamic music, turn up the level control corresponding to the midrange output until you hear slight distortion and turn back the level control slightly for an undistorted output. Depending on your system, the midrange and tweeter output may be on the same output channels.
- Step 6** Turn up the level control corresponding to the tweeter output until you hear slight distortion and turn back the level control slightly for an undistorted output. Depending on your system the midrange and tweeter output may be on the same output channels.
- Step 7** Fine tune the crossover setting and output level between the midrange and tweeters. Refer to the "Internal Cross over Configuration" section of this manual for detailed instructions.
- Step 8** Repeat Steps 5-7 for the rear speakers. If you do not have rear speakers continue to Step 10.
- Step 9** Set levels between the midrange and tweeters for optimum front/rear balance.
- Step 10** Turn up the level control corresponding to the woofer output until you hear slight distortion and turn back the level control slightly for an undistorted output.
- Step 11** Fine tune the crossover setting and output levels between satellite speakers and the woofers. Refer to the internal crossover configuration section of this manual for detailed instructions. If using an RGC-1, adjust the level to match the output of the woofer to match the sonic requirements of the system.

INSTALLATION TIPS

SYMPTOM	PROBABLE CAUSE	ACTION TO TAKE
No output	Low or no remote turn-on voltage	Check remote turn-on voltage at amplifier and repair as needed.
	Fuse blown	Check power wire integrity and check for speaker shorts. Fix as needed and replace fuse.
	Power wires not connected	Check power wire and ground connections and repair or replace as needed.
Audio cycles on and off	Audio input not connected speaker wires not connected speakers are blown	Check RCA connections and repair or replace as needed. Check speaker wires and prepair or replace as needed. Check system with known working speaker and repair or replace speakers as needed.
	Thermal protection engages when amplifier heatsink temperature exceeds 90°C (190°F)	Make sure there is proper ventilation for amplifier and improve ventilation as needed.
	Loose or poor audio input	Check RCA connections and reapiir or replace as needed.
Distorted output	Loose power connections	Check power wire and ground connedtions and repair or replace as needed.
	Amplifier level sensitivity set too high exceeding maximum capability of amplifier	Readjust gain. Refer to Adjusting the Sound of the System section of this manual for detailed instructions.
	Impedance load to amplifier too low	Check speaker impedance load, if below. 5 Ω stereo or 1 Ω mono. rewire speakers to achieve a higher impedance.
	Shorted speaker wires Speaker not connected to amplifier properly	Check wire connections and fix or replace as needed as needed. Check speaker wiring and reapiir or replace as needed. Refer to the Speaker Connections section of this manual for detailed instructions.

INSTALLATION TIPS

SYMPTOM	PROBABLE CAUSE	ACTION TO TAKE
Distorted output	Internal crossover not set proerly for speakers	Readjust corosovers. Refer to the Internal Crossover section of this manual for detailed instructions.
	Speakers are blown	Check system with known working speakers and fix or replace as needed.
Poor bass response	Speakers wired with wrong polarity causing cancellation at low frequency	Check speaker polarity and fix as needed.
	Corssover set incorrectly	Reset crossovers. Refer to the Internal Crossover Configuration section of this manual for detailed instructions.
mono	Impedance load at amplifier is too low	Check speaker impedance load, if below .5 Ohms stereo or 1 Ohms rewire speakers to achieve a higher impedance.
Battery fuse blowing	Short in power wire or incorrect wiring	Check power and ground connections are replace or repair as needed.
	Fuse used is smaller than recommended	Replace with proper fuse size.
Amplifier fusd	Too much current being draun	Check speaker impedance load. If below .5 Ohms stereo or 1 Ohms mono, rewire speakers to achieve a higher impedance and replace with recommended size fuse.
		Check power and ground connections and fix or repair as needed.
	Fuse used is smaller than recommended	Replace with proper fuse size.
	Impedance load at amplifier too low	Check speaker impedance load. If below .5 Ω stereo or 1 Ω mono, rewire speakers to achieve a higher impedance.
	Speaker is blown with shorted outputs	Check system with known working speakers and fix or replace as needed.

Free Manuals Download Website

<http://myh66.com>

<http://usermanuals.us>

<http://www.somanuals.com>

<http://www.4manuals.cc>

<http://www.manual-lib.com>

<http://www.404manual.com>

<http://www.luxmanual.com>

<http://aubethermostatmanual.com>

Golf course search by state

<http://golfingnear.com>

Email search by domain

<http://emailbydomain.com>

Auto manuals search

<http://auto.somanuals.com>

TV manuals search

<http://tv.somanuals.com>