



Multi Media Disc Player

MODEL : DVD-19

OWNER'S MANUAL

Before operating the unit, please read this manual carefully and completely, and retain it for future reference.



NOTE : THE DESIGNS & SPECIFICATIONS ARE SUBJECT TO CHANGE WITHOUT NOTICE FOR IMPROVEMENT

INTRODUCTION

Table of Contents

■ INTRODUCTION		■ INITIAL SETUP OPERATION	
Table of contents.....	2	Main Page.....	19
Safety Instructions.....	3	How to Setup.....	19
Parts Name		General Setup.....	21
-Front Panel.....	5	-Setting for TV Display.....	21
-Rear Panel.....	5	-Setting for Angle Mark.....	22
-Remote Control.....	6	-Setting for OSD Language.....	22
Using the Remote Control.....	7	-Setting for Captions.....	23
Inserting batteries.....	7	-Setting for Screen Saver.....	23
■ CONNECTIONS		Speaker Setup.....	24
Connection to a TV.....	8	-Setting for DownMix.....	24
Connection to an Audio System.....	9	Audio Setup.....	25
Connection to Optional Audio system		-Setting for SPDIF.....	25
-Dolby Digital sound.....	10	-Setting for Dual Mono.....	26
-Dolby Surround Sound.....	11	-Setting for Dynamic.....	26
■ BASIC OPERATION		Karaoke Setup.....	27
Basic Playback.....	12	Preferences.....	28
-Stopping Playback.....	13	■ REFERENCE	
-Still Picture(Pause).....	13	-Troubleshooting guide.....	29
-Skipping Forward or Backward.....	13	-Specifications.....	30
-Slow Playback.....	13	Copyright Protection Notice	
-Selecting TV Systems.....	14	This product incorporates copyright protection technology that is protected by method claims of certain U.S. patents and other intellectual property rights owned by Macrovision Corporation and other rights owners. Use of this copyright protection technology must be authorized by Macrovision Corporation, and is intended for home and other limited viewing uses only unless otherwise authorized by Macrovision Corporation. Reverse engineering or disassembly is prohibited.	
-Sound Mute.....	14	LABELLING REQUIREMENTS(Part 15.19 (a)(3))	
-High speed Playback.....	14	This device complies with Part 15 of the FCC Rules. Operation is subject to the following two conditions: (1) this device may not cause harmful interference, and (2) this device must accept any interference received, including interference that may cause undesired operations.	
-One step Playback.....	14	The instructions furnished the user shall include the following or similar statement, placed in a prominent location in the text of the manual.	
-Volume Control.....	14	INFORMATION TO THE USER (Part 15.105(b))	
-Key Control(Audio CD).....	14	For Class A digital device	
-To Convert Function Selection.....	14	INFORMATION TO THE USER	
■ ADVANCED OPERATION		This equipment has been tested and found to comply with the limits for a Class A digital device, pursuant to part 15 of the FCC Rules. These limits are designed to provide reasonable protection against harmful interference when the equipment is operated in a commercial environment. This equipment generates, uses, and can radiate radio frequency energy and, if not installed and used in accordance with the instruction manual, may cause harmful interference to radio communications. Operation of this equipment in a residential area is likely to cause harmful interference in which case the user will be required to correct the interference at his own expense.	
-Zoom feature.....	15	WARNING (Part 15.21)	
-Viewing from another angle.....	15	Changes or modifications not expressly approved by the manufacturer could void the user's authority to operate the equipment.	
-L/R Stereo Function(Audio-CD).....	15		
-Program playback(Audio-CD).....	16		
-Repeat playback.....	16		
-Search function.....	17		
-Using a title menu(DVD).....	17		
-Using a DVD Menu(DVD).....	17		
-Changing audio Language(DVD).....	18		
-Changing subtitle language(DVD).....	18		

INTRODUCTION

Safety Instructions



WARNING
RISK OF ELECTRIC
SHOCK DO NOT OPEN



The lightning flash with arrowhead symbol, within an equilateral triangle, is intended to alert the user to the presence of uninsulated "dangerous voltage" within the product's enclosure that may be of sufficient magnitude to constitute a risk of electric shock to persons.

WARNING : TO REDUCE THE RISK OF ELECTRIC SHOCK, DO NOT REMOVE COVER(OR BACK). NO USER SERVICEABLE PARTS INSIDE. REFER SERVICING TO QUALIFIED SERVICE PERSONNEL.



The exclamation point within an equilateral triangle is intended to alert the user to the presence of important operating and maintenance (servicing) instructions in the literature accompanying the appliance.

WARNING : TO REDUCE THE RISK OF FIRE OR ELECTRIC SHOCK, DO NOT EXPOSE THIS PRODUCT TO RAIN OR MOISTURE.

CAUTION : TO PREVENT ELECTRIC SHOCK, MATCH WIDE BLADE OF PLUG TO WIDE SLOT, FULLY INSERT.

CAUTION : This Digital Video Disc Player employs a Laser System. To ensure proper use of this product, please read this owner's manual carefully and retain for future reference, should the unit require maintenance, contact an authorized service location-see service procedure.

Use of controls, adjustments or the performance of procedures other than those specified may result herein hazardous radiation exposure.

To prevent direct exposure to laser beam, do not try to open the enclosure. Visible laser radiation when open the enclosure. DO NOT STARE INTO BEAM.

1. Read owner's manual
After unpacking this product, read the owner's manual carefully and follow all the operating and other instructions.
2. Power Sources
This product should be operated from DC12V of battery
3. Heat
The product should be situated away from heat sources (including amplifiers) that produce heat. During storms, or when it is left unattended and unused for long periods of time, unplug it from the wall outlet. This will prevent damage to the product due to lightning and power-line surges.
4. Keep drinks and cleaning solutions away from the body of the DVD.
5. Object and Liquid Entry
Never push objects of any kind into this product through openings as they may touch dangerous voltage points or short-out parts that could result in a fire or electric shock. Never spill liquid of any kind on the product.
6. Attachments
Do not use attachments not recommended by the product manufacturer as they may cause hazards.
7. Accessories
Any mounting of the product should follow the manufacturer's instructions, and should use a mounting accessory recommended by the manufacturer. Quick stops, excessive force, and uneven surfaces may cause the product and cart combination to overturn.
8. Disc Tray
Keep your fingers well clear of the disc tray as it is closing. It may cause serious personal injury.
9. Burden
Do not place a heavy object on or step on the product. The object may fall, causing serious personal injury and serious damage to the product.
10. Laser Beam
Do not look into the opening of the disc tray or ventilation opening of the product to see the source of the laser beam. It may cause sight damage.
11. Disc
Do not use a cracked, deformed, or repaired disc. These discs are easily broken and may cause serious personal injury and product malfunction.

INTRODUCTION

Safety Instructions

12. Damage Requiring Service

- a) When the power-supply cord is damaged.
- b) If liquid has been spilled, or objects have fallen into the product.
- c) If the product has been exposed to rain or water.
- d) If the product does not operate normally by following the operating instructions. Adjust only those controls that are covered by the operating instructions as an improper adjustment of other controls may result in damage and will often require extensive work by a qualified technician to restore the product to its normal operation.
- e) If the product has been dropped or damaged in any way.
- f) When the product exhibits a distinct change in performance-this indicates a need for service.

13. Servicing

Do not attempt to service this product yourself as opening or removing covers may expose you to dangerous voltage or other hazards. Refer all servicing to qualified service personnel.

14. Replacement parts

When replacement parts are required, be sure the service technician has used replacement parts specified by the manufacturer or have the same characteristics as the original part. Unauthorized substitutions may result in fire, electric shock, or other hazards.

15. Safety Check

Upon completion of any service or repairs to this product, ask the service technician to perform safety checks to determine that the product is in proper operating condition.

Note on Region Numbers

The region number is allocated to machine and software according to where they are sold.

DVDs can be played on this machine if their region number is the same or includes the same number, or if the DVD is marked "ALL".

Confirm the region number for this machine before choosing discs. The number for machine is indicated on the rear panel.

Notes on Copyrights

It is forbidden by law to copy, broadcast, show, broadcast on cable, play in public, and rent copyrighted material without permission.

INTRODUCTION

Front Panel

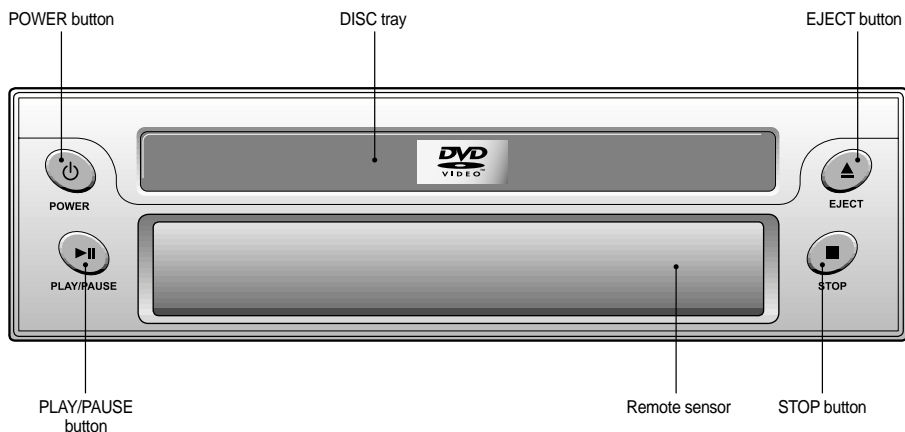

Rear Panel

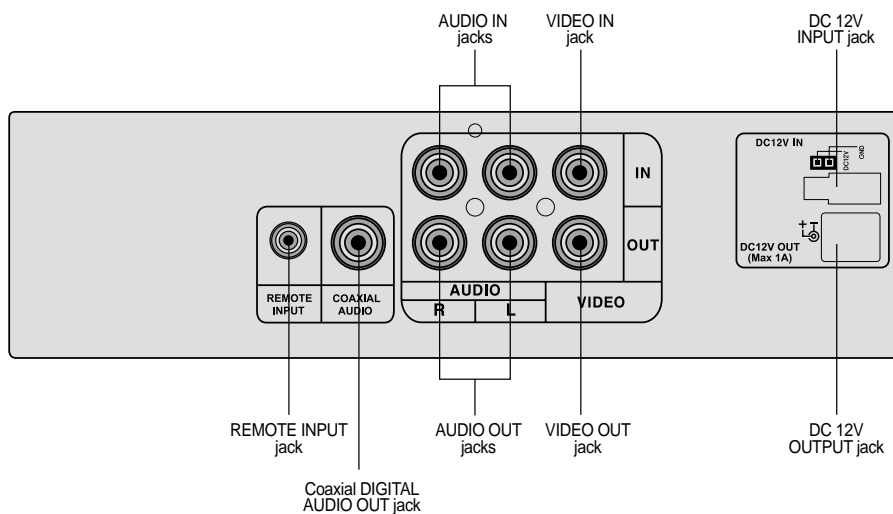

INTRODUCTION

Remote Control

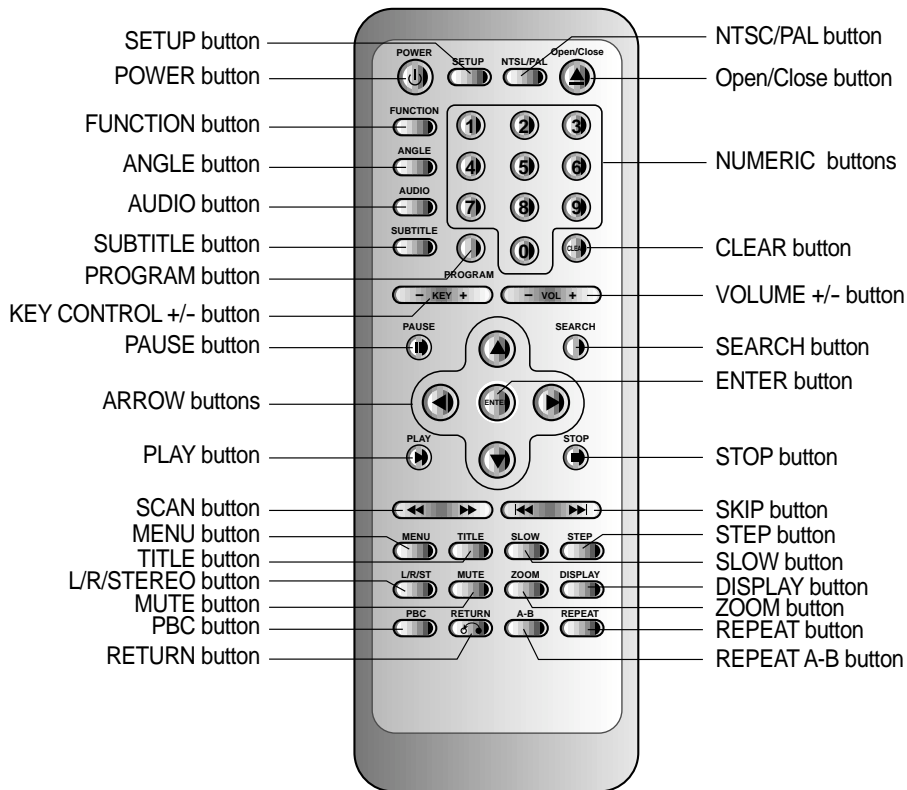

INTRODUCTION

Using the Remote Control

- When operating the remote control, point it at the remote control sensor as shown on the diagram.
- The remote control can be used from a direct distance of approximately 4~5 meters.
- The remote control can be operated at a horizontal angle of up to 25 degree with respect to the remote control sensor.

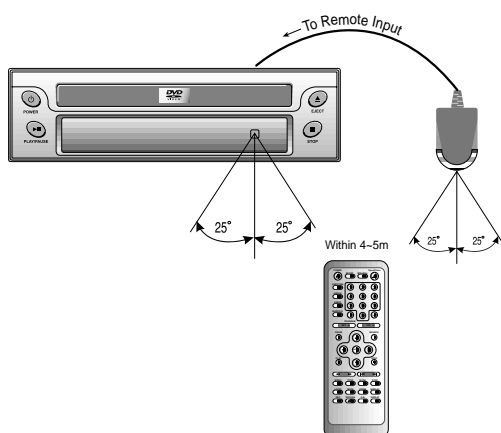

Inserting Batteries

- 1** Open the battery cover.
- 2** Insert batteries(AAA size).
Make sure to match the + and - on the batteries to the marks inside the battery compartment.
- 3** Close the cover.

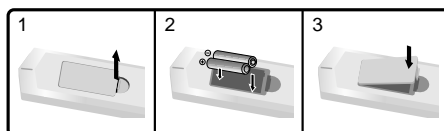

Notes

- Improper use of batteries may cause battery leakage and corrosion.
- Do not insert the batteries into the remote control in the wrong direction.
- If you do not use the remote control for a long period of time, remove the batteries to avoid possible damage from battery corrosion.
- If the remote control does not function correctly or if the operating range becomes reduced, replace all batteries with new ones.
- If battery leakage occurs, wipe the battery liquid from the battery compartment, then insert new batteries.
- Do not drop or give the remote control a shock.
- Do not leave the remote control near extremely hot or humid place.
- Do not spill water or put anything wet on the remote control.

CONNECTIONS

Connection to a TV

You can connect the player to your TV.

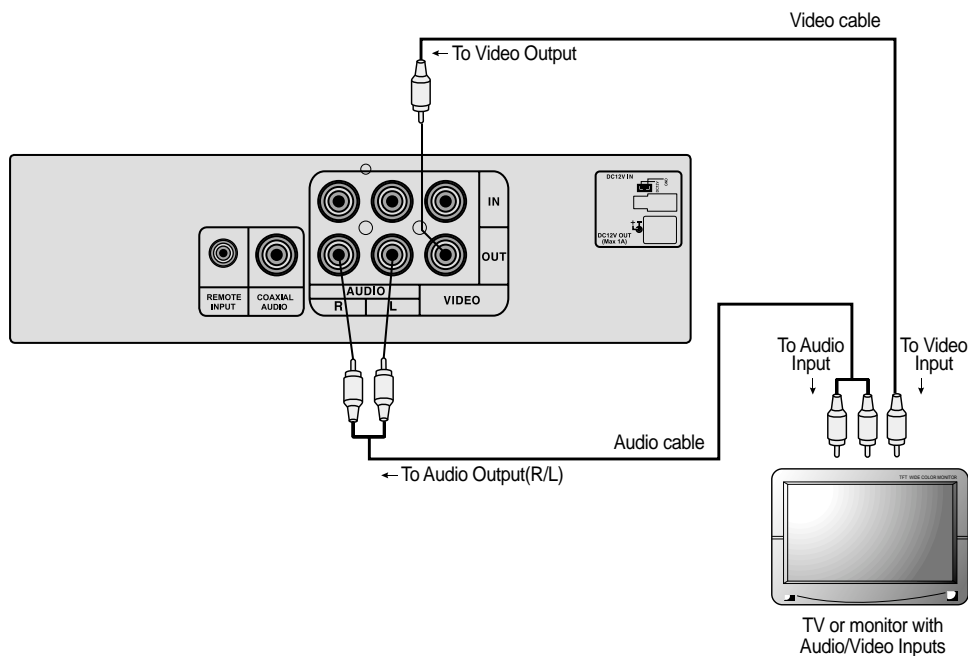

Notes

- Refer to the owner's manual of your TV as well.
- When you connect the player to your TV, be sure to turn off the power and unplug both units before making any connections.
- Connect the player to your TV directly. If you connect the player to a VCR, the playback picture will be distorted because video discs are copy protected.

CONNECTIONS

Connection to an Audio System

You can connect the player to your audio system and TV.

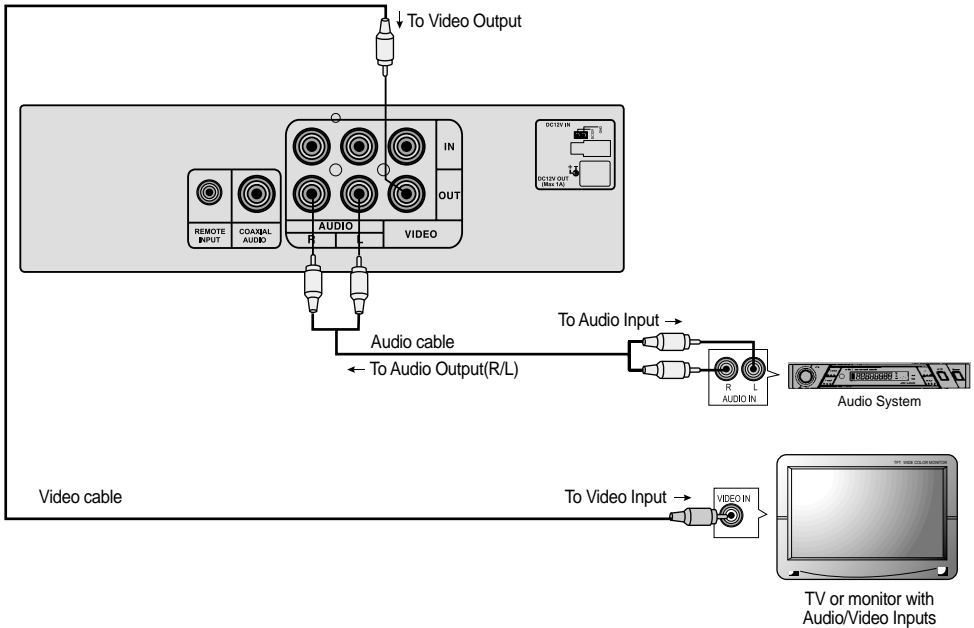

Notes

- Refer to the owner's manual of your car audio system as well.
- When you connect the player to other equipment, be sure to turn off the power and unplug all of the equipment before making any connections.
- If you place the player near a tuner or radio, the radio broadcast sound might be distorted. In this case, move the player away from the tuner and radio.
- The output sound of the player has a wide dynamic range. Be sure to adjust the receiver's volume to a moderate listening level. Otherwise, the speakers may be damaged by sudden high volume sound.
- Turn off the receiver before you connect or disconnect the player's power cord. If you leave the receiver the power on, the speakers may be damaged.

CONNECTIONS

Connection to Optional Audio System

Dolby Digital Sound

You can enjoy the high quality dynamic sound of Dolby Digital, Dolby Pro Logic, and 2 Channel Digital Stereo.

Dolby Digital

Dolby Digital is the surround sound technology used in theaters showing the latest movies, and is now available to reproduce this realistic effect in the car and home. You can enjoy motion picture and live concert DVD video discs with this dynamic realistic sound by connecting the DVD player to a 6 channel receiver equipped with a Dolby Digital decoder or Dolby Digital processor.

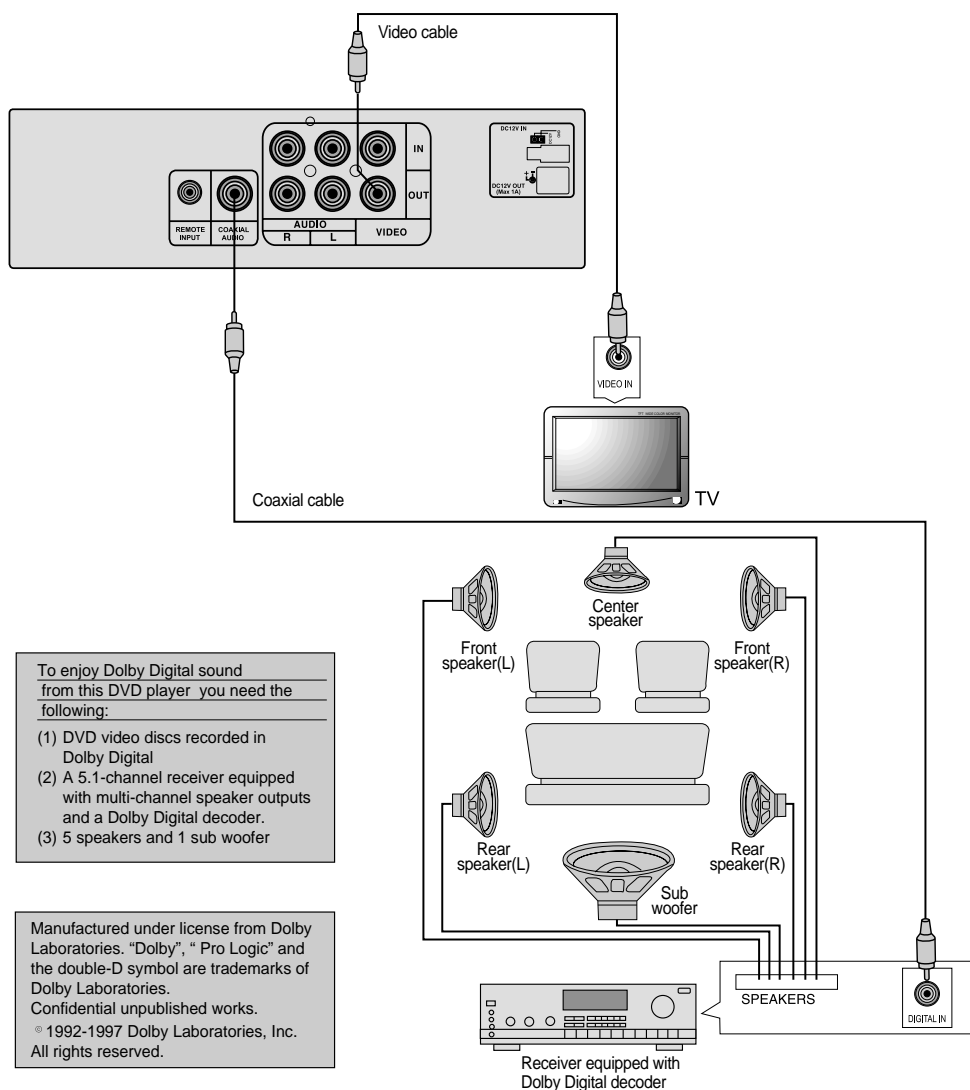

CONNECTIONS

Connection to Optional Audio System

Dolby Surround Sound

Dolby Surround

You can still enjoy the excitement of Surround Sound even if your A/V receiver does not offer Dolby Digital decoding. If your A/V receiver has a Dolby Surround decoder. Refer to the following connection diagram.

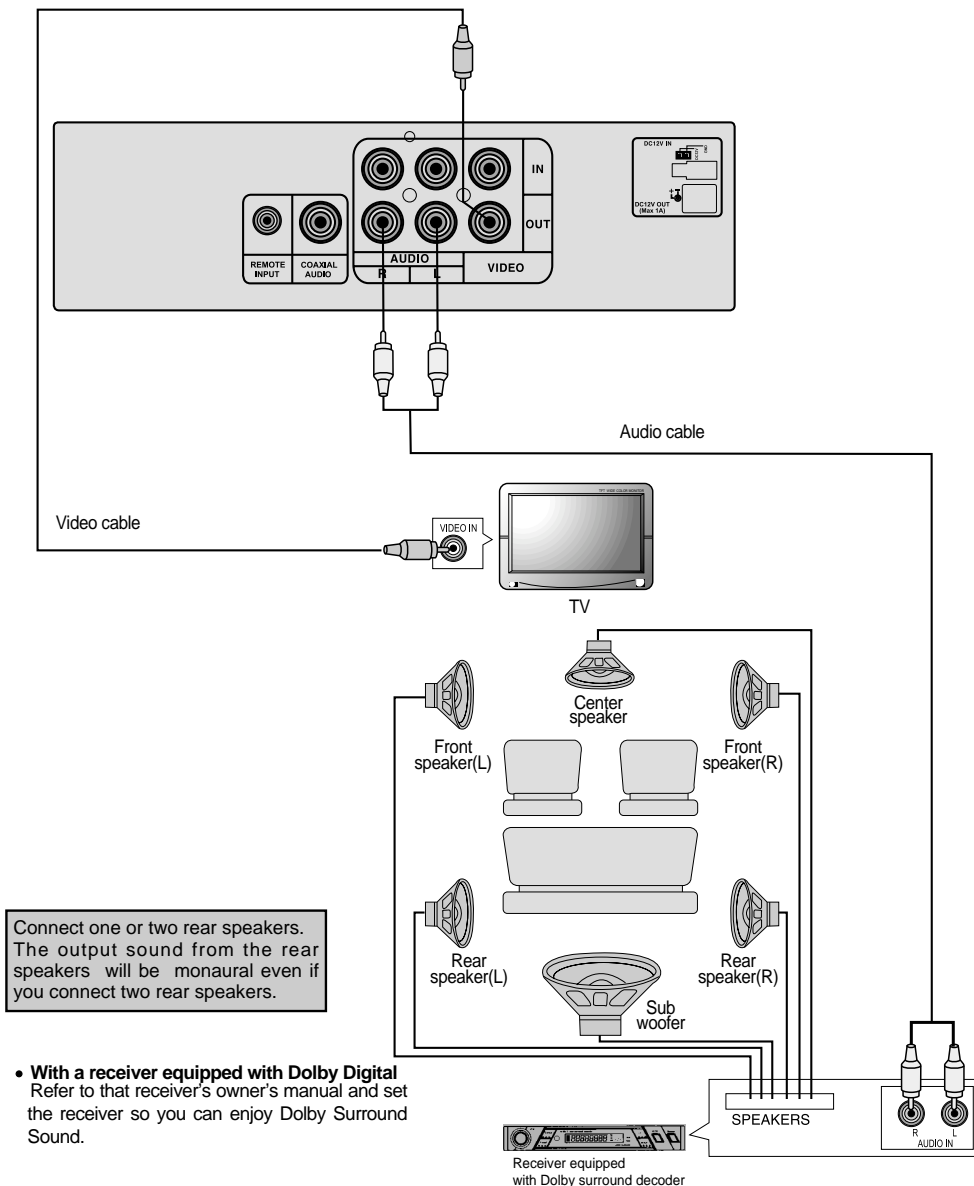

Connect one or two rear speakers. The output sound from the rear speakers will be monaural even if you connect two rear speakers.

- **With a receiver equipped with Dolby Digital**
Refer to that receiver's owner's manual and set the receiver so you can enjoy Dolby Surround Sound.

BASIC OPERATION

Basic Playback

Preparations

- When you want to playback DVD video discs, turn on the TV and select the video input source connected to the player.
- When you want to enjoy the sound of DVD video discs or audio CDs from the audio system, turn on the audio system and select the input source connected to the player.
- For connection details, see pages 8 through 11.
- Set the playback picture size according to the aspect ratio of the connected TV.

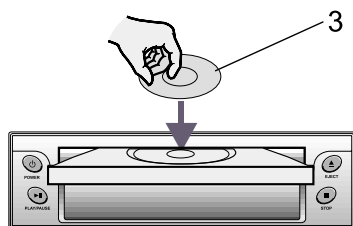
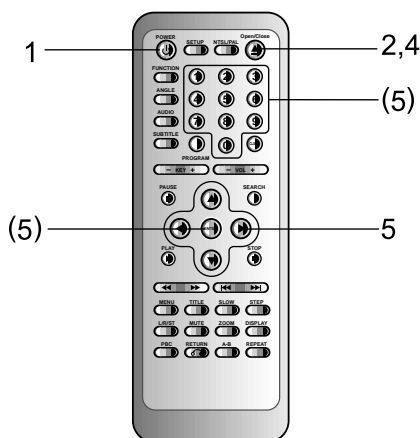

1 Press POWER button.

The player turns on.

2 Press OPEN/CLOSE button.

-The disc tray opens.

-You can open the disc tray by pressing this button even if the player is playback mode.

3 Place a disc on the disc tray with the playback side down.

-There are two different disc sizes. Place the disc in the correct guide on the disc tray. If the disc is out of the guide, it may damage the disc and cause the player to malfunction.

-Do not place anything except 3"(inches) discs or 5" discs on the disc tray.

4 Press OPEN/CLOSE button to close the loading drawer.

The player will begin playback automatically for all of the discs.

When a menu screen appears on the TV screen.

In case of interactive DVDs with control, a menu screen appears on the TV screen. Perform step as below.

5 Press ▲/▼/◀/▶ and press PLAY(ENTER) button, or press the numeric button(s) to select the desired item on the menu.

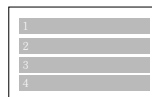

Example of interactive DVD On-screen Menu

- For further information refer to the jacket or case of the disc you are playing.

A note about Power off function

This player is equipped with the Aux function. If the player is powered off, it will be automatically switched to Aux.

Notes

- When "⏸" appears on the TV screen while a button is pressed it means that this function is not available on the disc you are playing.
- Depending on the DVD disc, some operations may be different or restricted. Refer to the jacket or case of the disc you are playing.

BASIC OPERATION

Basic Playback

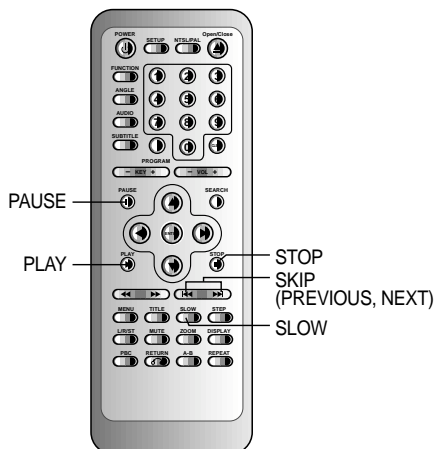

Stopping Playback

Press STOP button during playback.

- The player is in RESUME STOP mode and the stop position is stored in memory.
- If you press PLAY button, playback resumes from the position at which it was stopped.
- If you press the stop button once again the unit will cease playing the DVD but the memory will be maintained for 12 hours.
- During playback if you press the MENU button the player enters to the menu selection mode and the player is in resume stop mode and the stop position is stored in memory.
And you can control the menu operating.

Still Picture(Pause)

Press PAUSE button during playback.

DVD : The player will be placed in the still picture mode.
CD : The player will be placed in the pause mode.

To return to normal playback, press PLAY or PAUSE button.

Notes

- Some discs may not respond to still picture.
- Depending on the DVD disc, still picture operation may be different or restricted.

Skipping Forward or Backward

Skipping Forward

Press SKIP ►► button during playback.

A chapter (DVD) or a track (CD) is skipped each time the button is pressed.

Skipping Backward

Press SKIP ◀◀ button during playback.

A chapter (DVD) or a track (CD) is skipped backward, each time the button is pressed, if the time is less than 2 seconds. Otherwise, you can go to the start point of the chapter / track.

Slow Playback

When playing DVDs

Press SLOW button to see variable-speed slow picture during playback.

To return to normal playback, press PLAY button.

■ In case of DVD:

SF 2x → SF 4x → SF 8x → Release
(1/2 x speed forward slow screen) (Normal play)

Notes

- Some discs may not respond to slow playback.
- Depending on the DVD disc, slow playback operation may be different or restricted.

BASIC OPERATION

Basic Playback

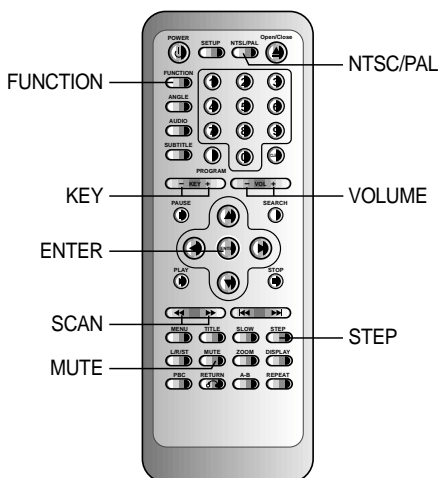

Selecting TV Systems

Press NTSC/PAL button and ENTER button on the remote control to set your TV color system during stop or resume stop mode.

If your TV is NTSC color system, select NTSC.

If your TV is PAL color system, select PAL.

If you select MULTI, TV color system is subject to the disc you play.

Notes

- The TV system setting must be coincided with the connected TV color system.
- Under the condition that the NTSC color system TV is connected, if you play a PAL color disc and you cannot see the regular pictures.

Sound Mute

Press the MUTE button to mute the sound of the player.

To cancel the mute function, press the MUTE button again or press the VOL +/- button.

If the volume level is zero, you cannot hear any sound.

High speed Playback

When playing DVD discs

Press SCAN(◀▶) button to see high speed picture during playback or pause.

- By pressing forward SCAN(▶) button or backward SCAN(◀) button, you can see variable speed picture.
- To return to normal playback, press PLAY button.

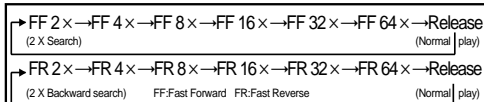

When playing an ordinary audio CD

It plays by fast forward or fast backward speed at $\times 2$, $\times 4$ and $\times 6$.

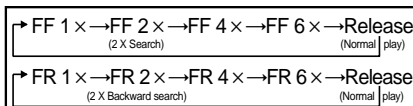

One Step Playback

When playing DVD discs

Press STEP button the player will enter step playing.

- Each time you press STEP button, the picture advances one frame.
- To return to normal playback, press PLAY(or PAUSE) button.

Volume Control

Press VOLUME + button on the remote control to increase the volume of the player.

Press VOLUME - button on the remote control to decrease the volume of the player.

Key Control(Audio CD)

If this player is selected Karaoke mode on the setup menu, then you can enjoy the Karaoke play. During Karaoke mode you can control the key by using the KEY +/- buttons on the remote control.

To Convert Function Selection

1. Press POWER button to turn on the player.
2. Press FUNCTION button to select the A/V-OUT you want. A/V-OUT will be switched and selected whenever you press the button.
(AUX IN → DVD → AUX IN...)
3. If you are in power off, the function is switched to the AUX IN.

ADVANCED OPERATION

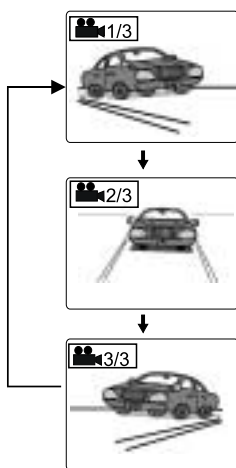
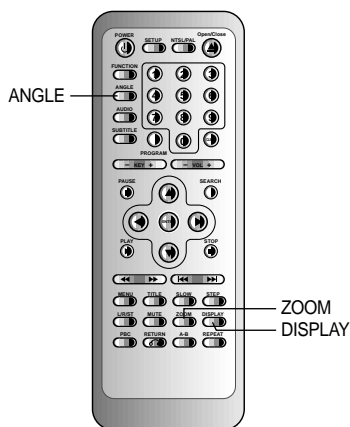

Zoom feature

Press ZOOM button during normal playback or still playback.

The Zoom feature allows to enlarge the picture on the screen.

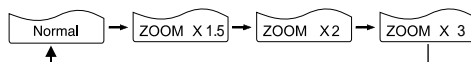

Each time you press ▲/▼/◀/▶ buttons, the zoom point shifts.

Note

- Some discs may not respond to zoom feature.
- Depending on the DVD disc, zoom operation may be different or restricted.

Viewing from another angle

Some DVDs may contain scenes which have been shot simultaneously from a number of different angles.

For these discs, the same scene can be viewed from each of these different angles using the ANGLE button. (The recorded angles differ depending on the disc used.)

1 Press ANGLE button during playback if you can use angle mark.

-The next angle number is displayed.

2 Press ANGLE button repeatedly until the desired angle is selected.

Note

- This ANGLE function works only for discs having scenes recorded at a different angles.

L/R/Stereo Function(Audio-CD)

Using L/R/ST function, the Left-mono. Right-mono or Stereo can be selected and played. And use it when playing a disc with Sound Multiplex logo.

According to the selection of L/R/Stereo function, the sound will be output from the front Right of the front Left channel as the following table:

Button select	Output	
	L-channel	R-channel
STEREO	L-CH signal on the disc	R-CH signal on the disc
RIGHT	R-CH signal on the disc	R-CH signal on the disc
LEFT	L-CH signal on the disc	L-CH signal on the disc

ADVANCED OPERATION

Program playback (Audio-CD)

Program playback lets to set up a specific order for playback of tracks on a disc.

- 1 Press the PROGRAM button during stop mode.**
- 2 Press the NUMERIC buttons as you want.**
- 3 To start the program play, press the PLAY button.**
- 4 To cancel the play, press the STOP button and the PROGRAM button twice.**

Repeat playback

You can playback chapter, title, or tracks repeatedly. Set this function during playback.

- **PRESET** : Press REPEAT button when title, chapter, folder or song for repetition is played.
- Repetition play mode changes as shown below whenever you press this button and relevant mode appears in TV screen.

In case of DVD:

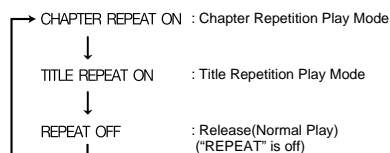

In case of CD:



- To release Repetition Play Mode and start normal play, repetitively press REPEAT button until "REPEAT OFF" is displayed in TV screen.

Setting the Repeat A-B playback

1. Press A-B button during play at the point where repeat play is to start(A)
2. Press A-B during play at the point where repeat play is to be concluded(B)
3. To cancel it press A-B button again.

Notes

- Repeat play works only with discs for which the elapsed playing time appears in the DVD display window during playback.
- Repeat play may not work correctly with some DVDs.
- If the time from A to B is less than 3 seconds, the player repeats about 3 seconds.
- Repeat A-B play works only within a title DVD or a track CD. Some subtitles recorded around point A or B may fail to appear (DVD).
- During repeat playback, if you need to play a certain track and you can select the track by using the NUMERIC or SKIP buttons.
- Depending on the discs, this function may be different.

ADVANCED OPERATION

Changing audio language(DVD)

It is possible to change the audio language to a different language from the one selected at the initial settings.

This operation works only with discs on which multiple audio languages are recorded.

Press AUDIO button repeatedly to select the desired audio language.

Note

When the desired audio language is not selected even after pressing the button several times, it means that the language is not available on the disc.

Changing subtitle language(DVD)

It is possible to change the subtitle language to a different language from the one selected at the initial settings. This operation works only with discs on which multiple subtitle languages are recorded.

Press SUBTITLE button repeatedly during playback to select the desired subtitle language.

Note

When the desired subtitle language is not selected even after pressing the button several times, it means that the language is not available on the disc.

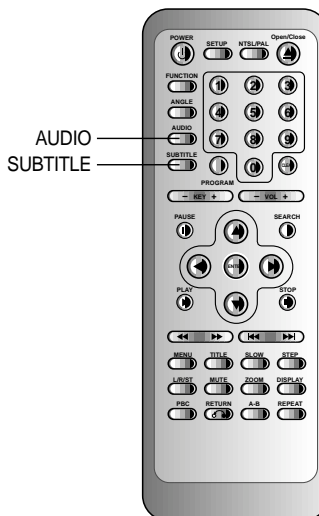

INITIAL SETUP OPERATION

Main Page

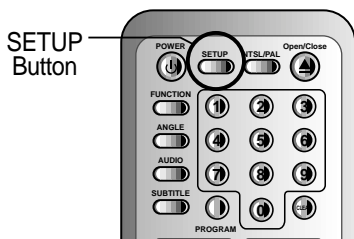

If pressing "SETUP Button" on the remote control, you can see the followings on the TV screen.

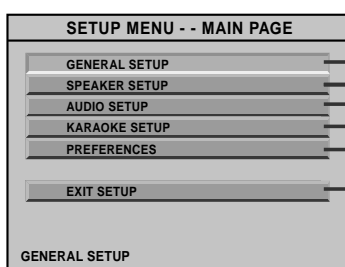
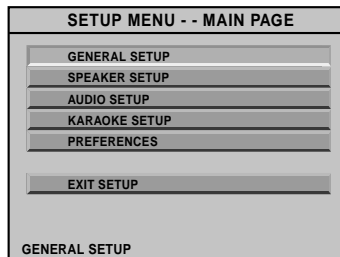

You can set up such general functions as TV Display, Angle Mark, OSD Language, Captions and Screen Saver.

You can adjust the number of output channels in accordance with that of output speakers.

You can set up SPDIF, Dual Mono and Dynamic.

You can set up Karaoke ON/OFF.

You can set up TV Type, Audio, Subtitle, Disc Menu, Locality code, Parental Control, Password setup and so forth.

After setting up, you can exit from the setup menu.

How to Setup

1

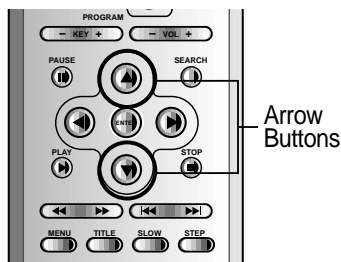

If using "Arrow Buttons" on the remote control as shown in the main page, you can scroll where you want.

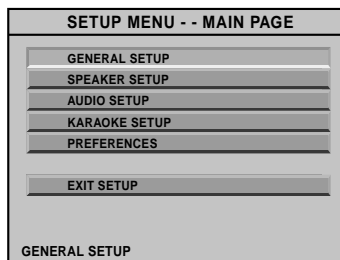

2

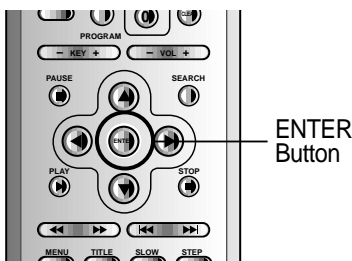

If pressing "ENTER Button" at the menu that you have selected, you can see the following selection menu.

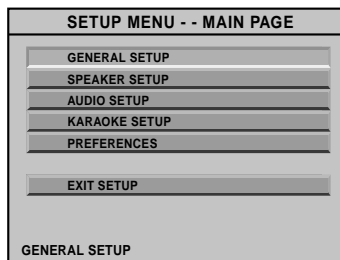

INITIAL SETUP OPERATION

How to Setup

3.

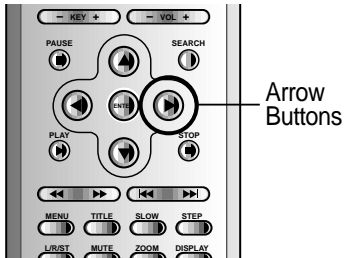

If using "Arrow Buttons" at the menu you want to set up, you can scroll to sub-items.

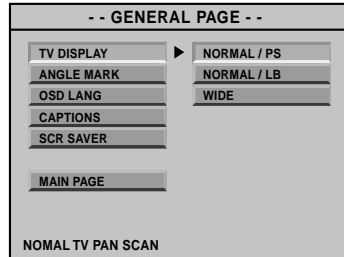

4.

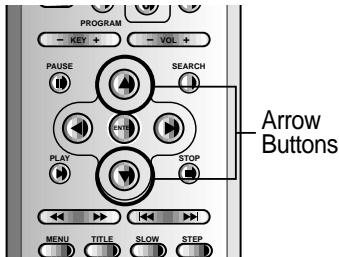

If using "Arrow Buttons" on the remote control, you can scroll where you want.

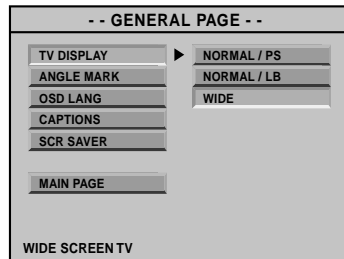

5.

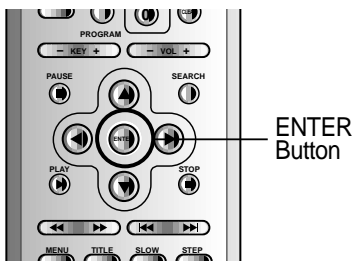

You can select using "ENTER Button" on the remote control.

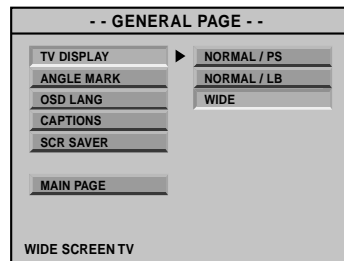

6.

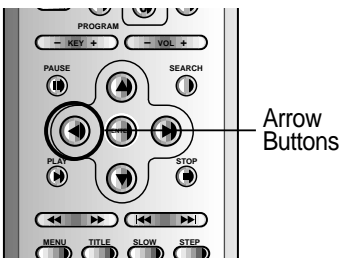

You can back to the upper menu using "Arrow Buttons" on the remote control, or finish setting up pressing "SETUP Button".

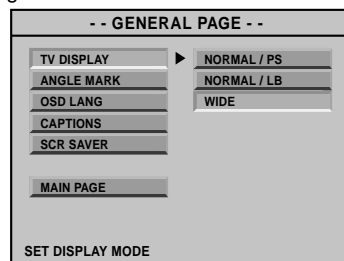

INITIAL SETUP OPERATION

General Setup

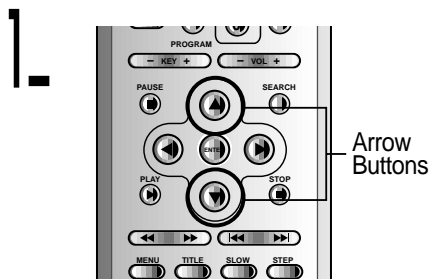

You can scroll to the "General Setup" menu using "Arrow Buttons" on the remote control as shown in the main page.

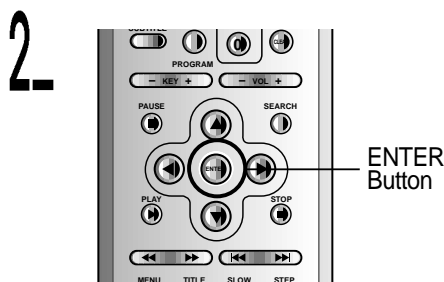
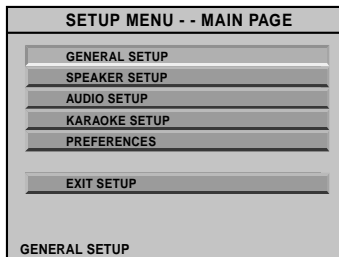

If pressing "ENTER Button" on the remote control at the "General Setup" menu, you can see the following sub-selection menu.

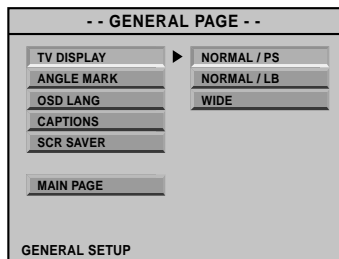

Setting for TV Display

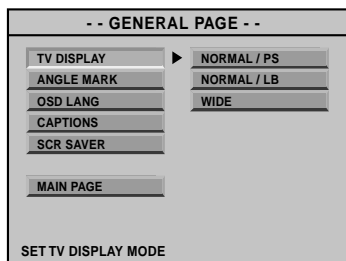

However, if the disc is designed to provide video in the ratio of 4:3, the following setup enables you to enjoy a wide screen.

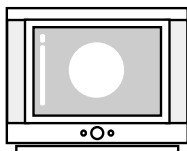

NORMAL/PS

Normal TV Pan Scan - You can select this mode where you can enjoy the screen in the ratio of 4:3 on TV with 4:3, or the screen of 16:9 expanded to be matched with 4:3.

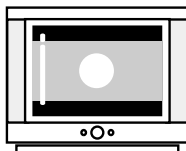

NORMAL/LB

Normal TV Letter Box - You can select this mode where you can enjoy the screen in the ratio of 16:9 on TV with 4:3, but you will see a black band on the upper and lower screen.

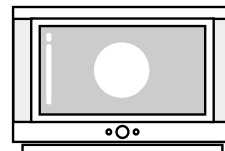

WIDE

Wide Screen TV - If your TV is in the ratio of 16:9, you can select this mode.

INITIAL SETUP OPERATION

General Setup

Setting for Angle Mark

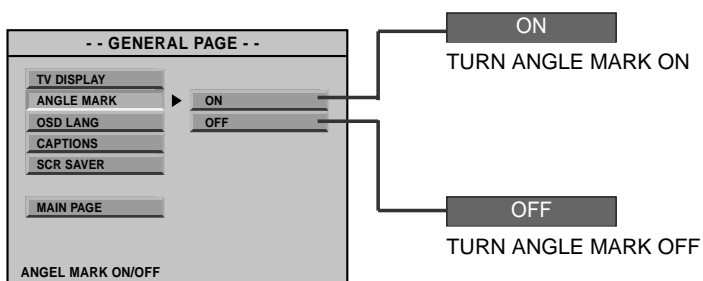

Setting for Angle Mark is available only if the disc contains the multi-angled scenes.

Setting for OSD Language

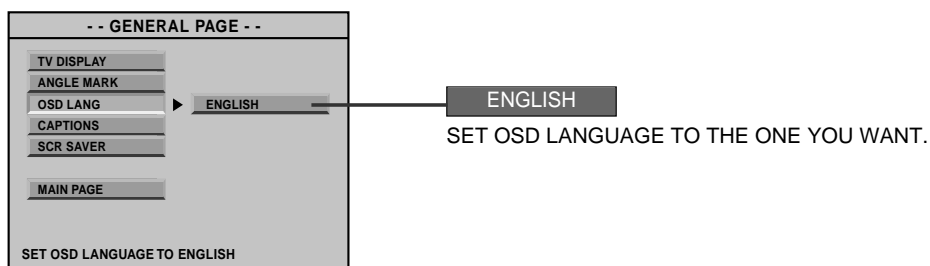

Set OSD language to the one which you want.

INITIAL SETUP OPERATION

General Setup

Setting for Captions

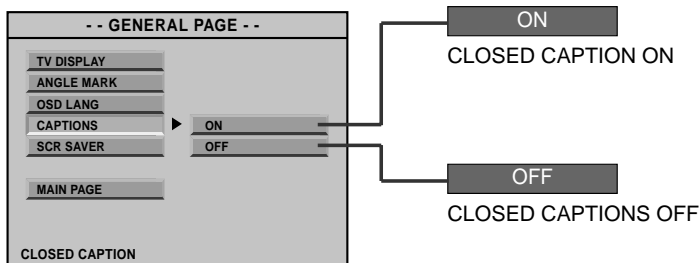

Setting for Screen Saver

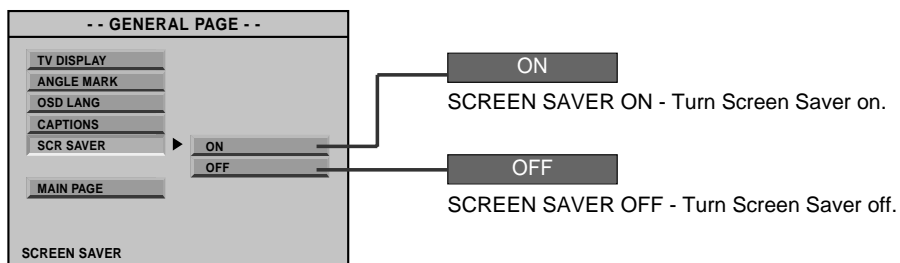

The function "Screen Saver" darkens the screen on which the SPOT moves around if DVD is not used for a long time.

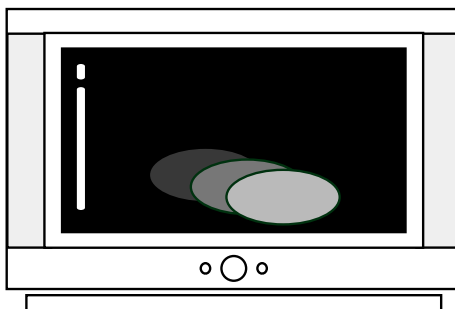

INITIAL SETUP OPERATION

Speaker Setup

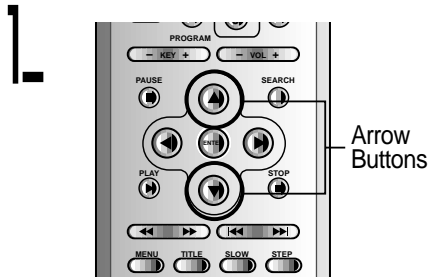

You can scroll to the "Speaker Setup" menu using "Arrow Buttons" on the remote control as shown in the main page.

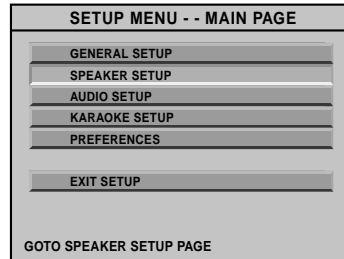

You can see the followings if pressing "ENTER Button" on the remote control at the "Speaker Setup" menu.

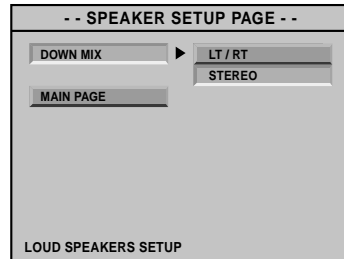
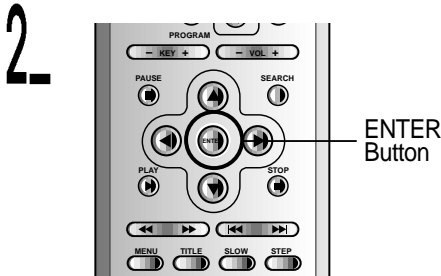

Setting for DownMix

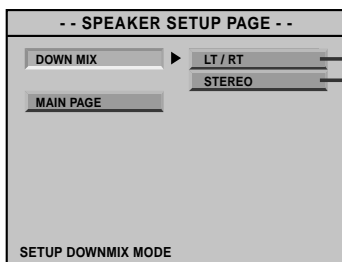

LT/RT
SET LT/RT DOWNMIX - Only if you want to hear the speaker sounds of front left/right of the original, by two channel, you select "LT/RT" downmix.

STEREO
SET STEREO DOWNMIX - If you want to hear the all speaker sounds of the original, by two channel, you select "STEREO" downmix.

"DOWNMIX" optimizes the number of the output channel suitable for that of the speaker.

INITIAL SETUP OPERATION

Audio Setup

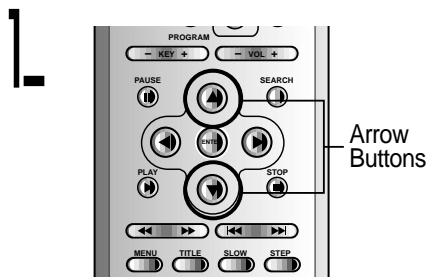

You can scroll to the "Audio Setup" menu using "Arrow Buttons" on the remote control as shown in the main page.

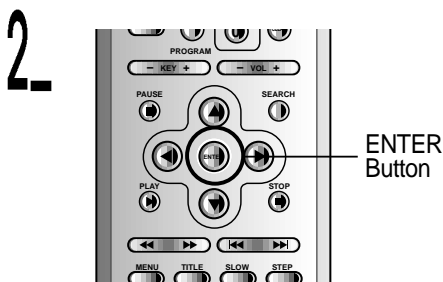
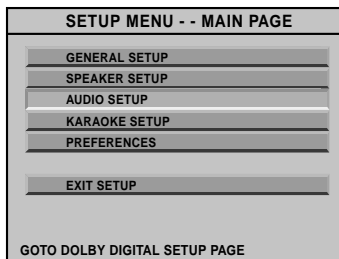

You can see the followings if pressing "ENTER" Button" on the remote control at the "Audio Setup" menu.

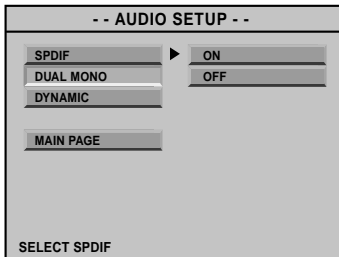

Setting for SPDIF

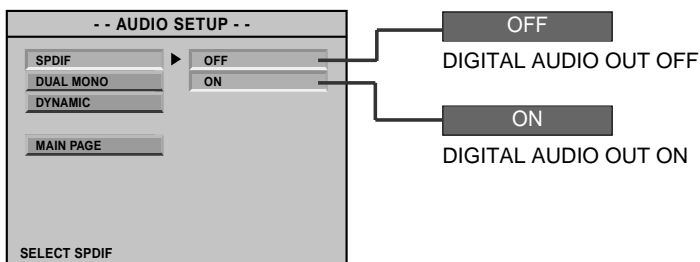

If you don't select "ON", you cannot hear any sound through Digital output.

INITIAL SETUP OPERATION

Audio Setup

Setting for Dual Mono

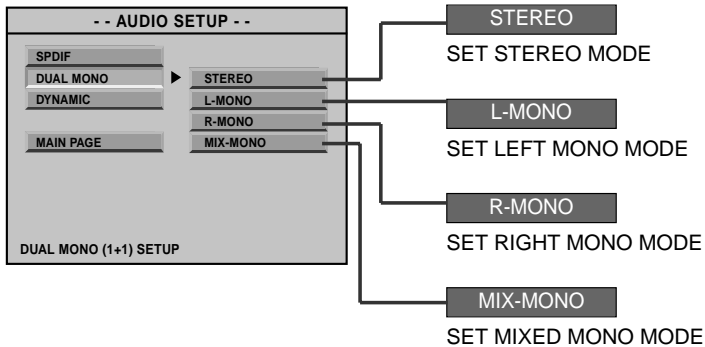

"DUAL MONO" as is the mode for multi-sound broadcasting enables you to hear the sound from one set of speakers output also from the other set.

Setting for Dynamic

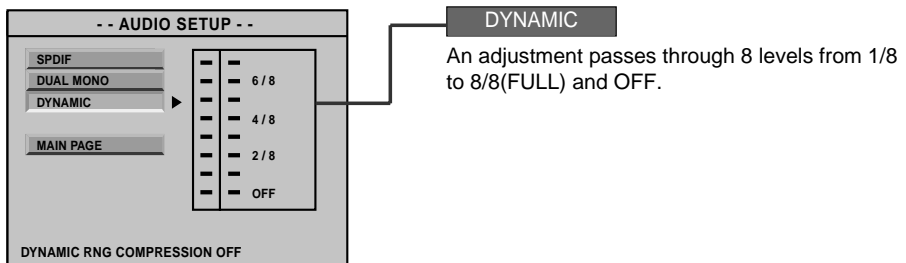

"Dynamic Range" refers to the range of a change in sound volume (dB) between its maximum value and its minimum value with a specific media given.

INITIAL SETUP OPERATION

Karaoke Setup

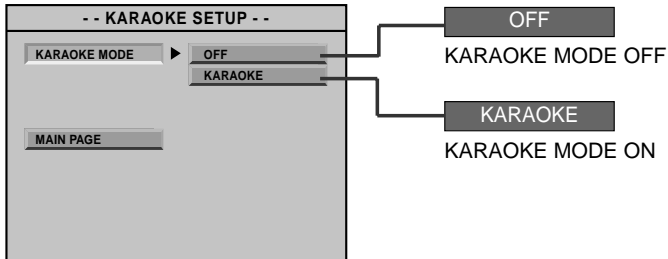

INITIAL SETUP OPERATION

Preferences

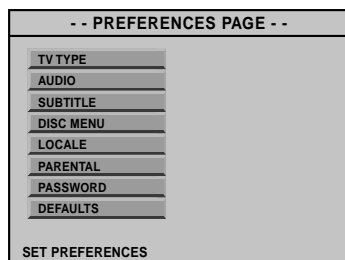

If the disc doesn't support "PREFERENCES", you can't set it up. For example, when you play some disc.

"LOCALITY CODE" refers to allocating each locality code per all the players and the DVD titles with the world divided into 6 zones.

TV TYPE

PREFERRED TV SIGNAL - You can select among the following TV signal :

Multi Sync TV - You can use this mode if your TV supports both NTSC and PAL.

NTSC TV - NTSC TV is adopted mainly in Korea, Japan, the US, and Canada.

PAL TV - PAL TV is adopted mainly in Europe.

AUDIO

PREFERRED AUDIO LANGUAGE

SUBTITLE

PREFERRED SUBTITLE LANGUAGE

DISC MENU

PREFERRED MENU LANGUAGE

LOCALE

PARENTAL LOCALITY CODE - You can select a locality code. Make sure to select a code suitable for the locality code of the disc to play.

PARENTAL

SET PARENTAL LEVEL - You can set up "Parental Level" in 8 levels so that children couldn't watch such programs as are too violent or only for adults.

PASSWORD

CHANGE PASSWORD - You can change password.

If you forgot the password, you can input the numbers, "5700".

DEFAULTS

LOAD FACTORY SETTING - You can set up the setup menu to its defaults.

REFERENCE

Troubleshooting Guide

Check the following guide for the possible cause of a problem before contacting service.

Symptom	Cause	Correction
No Power	The power cord is disconnected.	Plug the power cord into the battery outlet securely.
The power is on, but the player does not work.	No disc is inserted.	Insert a disc. (Check that the DVD or audio CD indicator in the display is lit.)
No picture.	The TV is not set to receive DVD signal output.	Select the appropriate video input mode on the TV so the picture from the player appears on the TV screen.
	The video cable is not connected securely.	Connect the video cable into the jacks.
	The connected TV power is turned off.	Turn on the TV.
No sound.	The equipment connected with the audio cable is not set to receive DVD signal output.	Select the correct input mode of the audio receiver so you can listen to the sound from the player.
	The audio cables are not connected securely.	Connect the audio cable into the jacks securely.
	The power of the equipment connected with the audio cable is turned off.	Turn on the equipment connected with the audio cable.
	The Digital Audio Output is set to the wrong position.	Set the Digital Audio Output to the correct position, then turn on the player again by pressing the POWER button.
The playback picture is poor.	The disc is dirty.	Clean the disc.
The player does not start playback.	No disc is inserted.	Insert a disc. (Check that the DVD, or audio CD indicator in the display is lit.)
	An unplayable disc is inserted.	Insert a playable disc. (Check the disc type, color system and Regional code.)
	The disc is placed upside down.	Place the disc with the playback side down.
	The disc is not placed within the guide.	Place the disc on the disc tray correctly inside the guide.
	The disc is dirty.	Clean the disc.
	A menu is on the TV screen.	Press the SETUP button to turn off the menu screen.
The Remote control does not work properly	The remote control is not pointed at the remote sensor of the player.	Point the remote control at the remote sensor of the player.
	The remote control is too far from the player.	Operate the remote control within about 5m.
	There is an obstacle in the path of the remote control and the player.	Remove the obstacle.
	The batteries in the remote control are exhausted.	Replace the batteries with new ones.
The POWER button and the other buttons are not operated.	The buttons or screen holding error may occur by some discs.	In this case unplug the power cord of the player, and then plug in the power cord again.

REFERENCE

Specifications

Power Source		DC 12V
Power Consumption		12W
Weight		1.4 kg
Dimensions(Widthx Height x Depth)		178mm (W) x 51mm (H) x 217mm (D)
Signal System		NTSC/PAL
Audio	Frequency Response	20 Hz - 20 kHz
	Output level (Analog)	2.0 V(rms)
	S/N Ratio	90 dB(1kHz JIS-A Filter)
Video	Output level	1.0 Vp-p / 75Ω
Environment	Temperature	5°C ~ 35°C
	Humidity	30% ~ 60%
	Condition	Horizontally
Accessories supplied		Remote control1 Battery (AAA)2 Power Cable1 External remote receiver1 A/V Cable.....1

* Designs and specifications are subject to change without notice for improvement.

Free Manuals Download Website

<http://myh66.com>

<http://usermanuals.us>

<http://www.somanuals.com>

<http://www.4manuals.cc>

<http://www.manual-lib.com>

<http://www.404manual.com>

<http://www.luxmanual.com>

<http://aubethermostatmanual.com>

Golf course search by state

<http://golfingnear.com>

Email search by domain

<http://emailbydomain.com>

Auto manuals search

<http://auto.somanuals.com>

TV manuals search

<http://tv.somanuals.com>