

Portable MP3 player

EV64AMX

Operating Instructions



Dear Customer

Thank you for purchasing this product.

For optimum performance and safety, please read these instructions carefully.

Before connecting, operating or adjusting this product, please read these instructions completely. Please keep this manual for future reference.

Table of Contents

1 Introduction

[Package](#).....4
[Location of Controls](#)5
[HOLD Function](#).....6

2 Setting Up the player

[Install software](#).....7
[Connect to Your PC](#).....9
[Download MP3 files to the unit](#).....11

3 Using the player

[LCD and Menus](#)..... 12
[Play MP3 Music \(Basic Play\)](#)..... 13
[Play Settings](#)..... 14
[Record Voice](#)..... 15
[Erase Music and Record File\(s\)](#)..... 16
[Information Submenu](#)..... 17

Appendixes

A [What is MP3?](#)..... 18
B [Cautions](#)..... 19
C [Software Utility](#)..... 20
D [Technical Specifications & Troubleshooting](#)..... 21

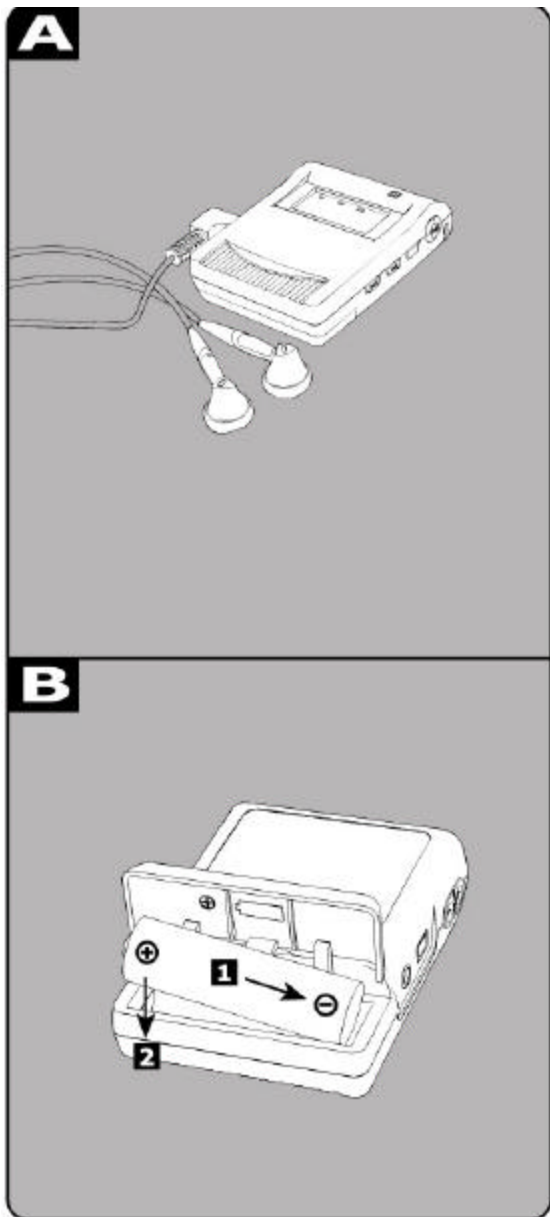

Using the battery **B**

Install battery procedure

- 1 Press and Pull to open battery door **A**
- 2 Insert the AA alkaline type battery.
- 3 Cover and Push to close battery door.

Package

Please check the box contents before you start to use the unit.

Box Contents : A

- [1] MP3 player
- [2] 1 installation CD
- [3] USB cable
- [4] High-quality stereo earphones

Item may be different, depending on the country or period that you purchased your player in.

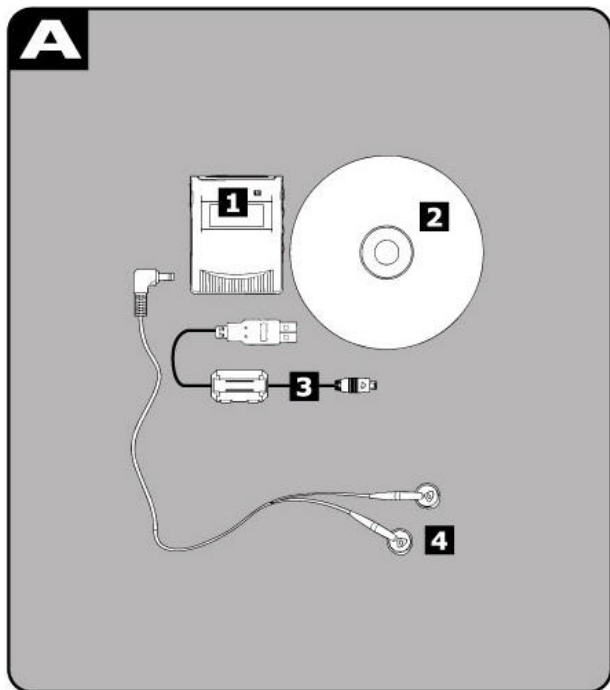

Locations of Controls

Portable MP3 player **A**

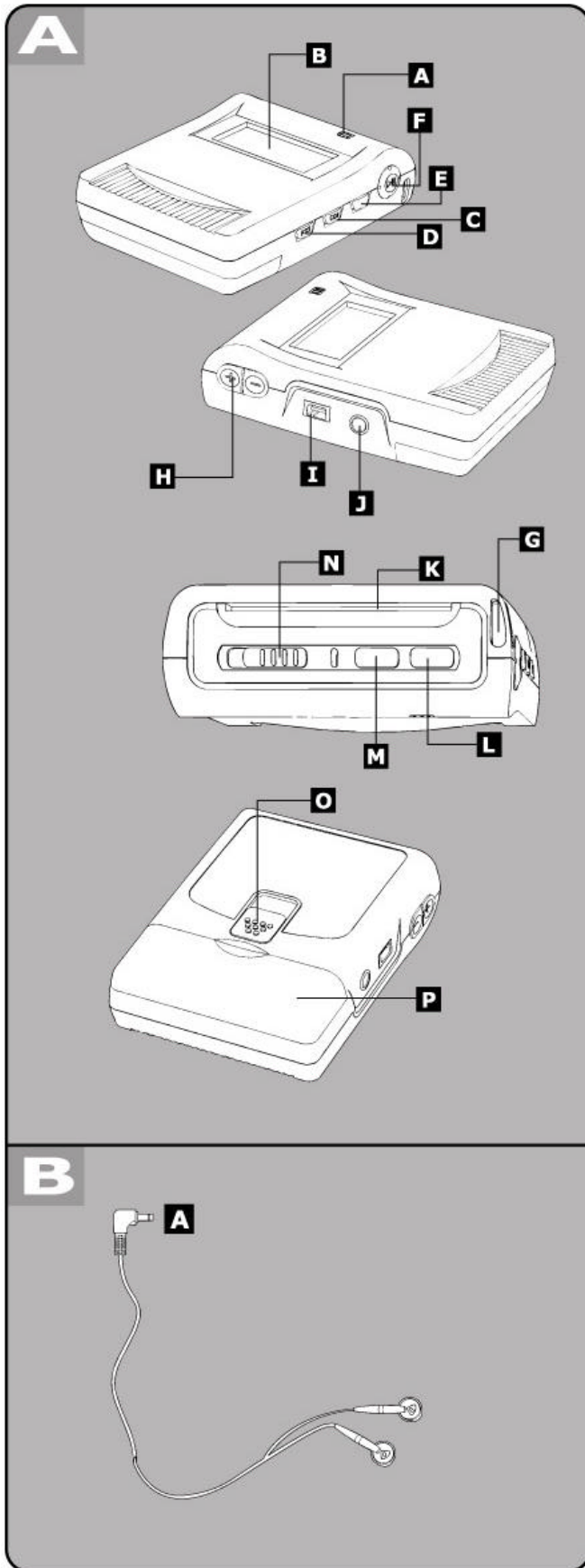

- [A] Microphone (MIC)
- [B] Display
- [C] Skip to Next (SKIP)
- [D] Skip to Previous (SKIP)
- [E] Mode button (MODE)
- [F] Play/pause/Power button
- [G] Belt hole
- [H] Earphone Volume control buttons (VOLUME + / -)
- [I] USB port (USB)
- [J] Earphone jack (PHONE)
- [K] Smart Media Card Slot
- [L] Stop/power off button (STOP/OFF)
- [M] Record button (REC)
- [N] Hold button (HOLD)
- [O] Smart Media Card Eject (EJECT)
- [P] Battery door open (OPEN)

[Play]: Press this button to turn on the unit, play music and/or voice file;

[SKIP]: Press the two buttons to skip to next/previous music or move to next menu.

[STOP/OFF] : Press to stop a music or recording; Press and hold for 4 seconds to turn the unit off.

[MODE]: Press the button to enter menu, or confirm the selected options.

Stereo earphones **B**

- (A) Plug

HOLD Function

This function causes the unit to ignore short, accidental button presses.

The HOLD function prevents the following :

- The unit is powered on accidentally when not in use, causing the batteries to run down.
- A button is accidentally pressed during play, interrupting the operation.

To use the HOLD function

Set [HOLD] to the HOLD position.

(A) HOLD mode

(B) Release

When the unit is in hold mode:

Pressing the unit is in hold mode:

The indicator “hold” always displays on the LCD display.

Pressing any button causes no any change to the unit.

If turn on the unit in hold mode:

The unit will displays ‘Locked’ on LCD screen and power off.

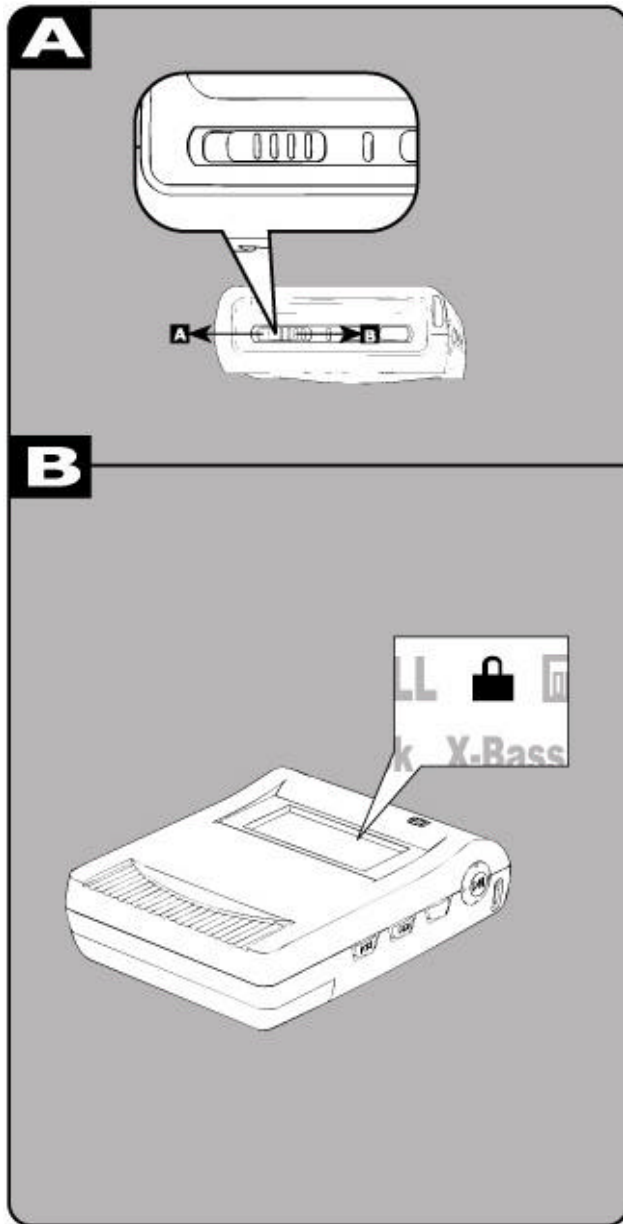

Install Software

Before using the unit, MP3 music shall be downloaded from computer to the unit. Data files such as pictures, documents or applications can also be downloaded and stored in the unit for a fast, safe and high speed mobile data storage use.

Minimum System Requirement

Windows : Microsoft Windows 98, Windows 98SE, Windows Me!, Windows 2000 Professional and Windows XP or above

Hardware : Pentium MMX 200 or above
30MB free hard disk space

One available USB port

4x CD-ROM or higher

Macintosh OS : MAC OS 9.2

Mac Hardware : 30MB free hard disk space

One available USB port

4x CD-ROM or higher

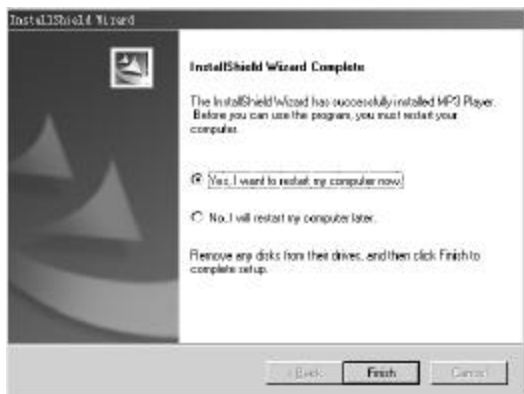
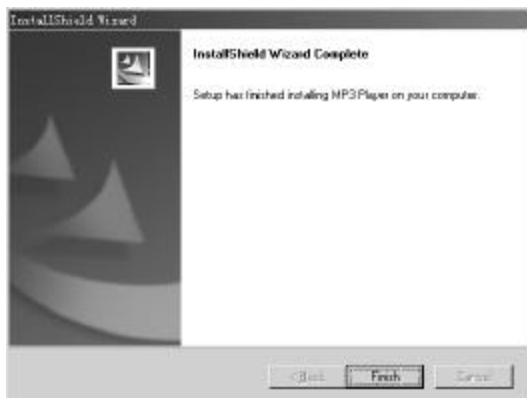
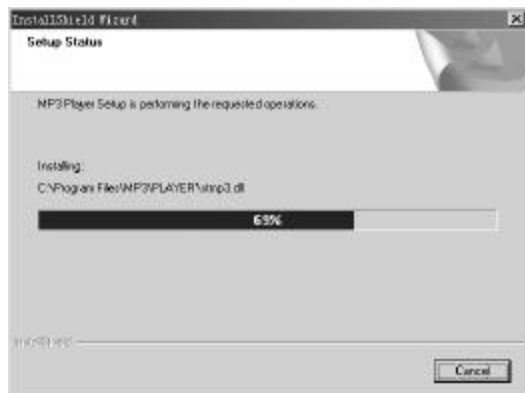
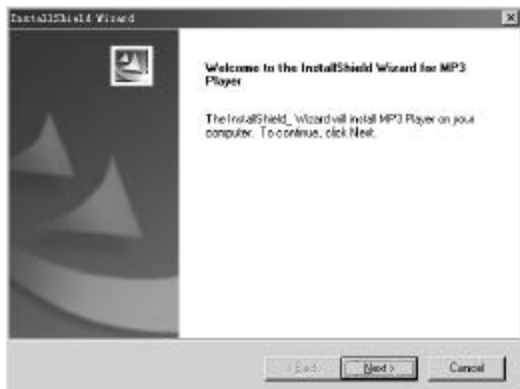

For Windows

1. Insert the Installation CD into the CD-ROM driver. If the Setup program does not run automatically, do steps 2 through 3. Otherwise, skip to step 4.
2. Click **Start** -> **Run**
3. In the **Run** dialog, type D:\SETUP.EXE (where D:\ is your CD-ROM drive) and click **OK**.
4. Setup main screen will display. To install the driver and application for the unit, Click **Next**
5. Follow the instructions on the screen. Click on the Right Arrow button to start Installation. Keep on clicking on the Right Arrow or Yes button if you want to install by default (recommended). Otherwise please change the options to install manually.
6. When prompted to restart your system, take the Installation CD out from the CD-ROM and keep it in a security place. Then select the **Yes, I want to restart my computer now** option and then click the **Finish** button.

(Continued on next page)

Install Software

For Macintosh

1. Insert the Installation CD into the CD-ROM drive.
2. Double-Click on the icon of the CD-ROM drive on desktop.
3. Open the Mac_OS folder in CD-ROM drive and open the packed file.
4. In the dialogue window, create a new folder on hard disc and continue
5. Open the new folder and double-click on ' Install and Setup' icon.
6. Follow the instructions on the screen.
7. When prompted to restart your system, take the Installation CD out from the CD-ROM and keep it in a security place. Then click the **Restart** button.

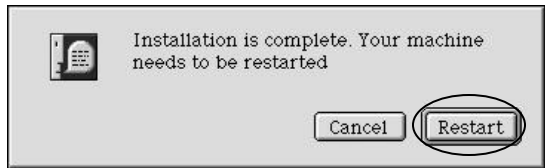
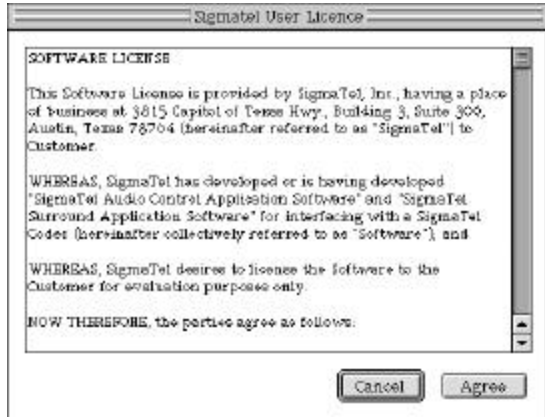

Musicmatch Setup screen--

Install musicmatch (Windows version)

1. Open directory D:\musicmatch\ (where D:\ is your CD-ROM drive) in explore.
2. Double click on the  musicmatch icon.
3. Setup program starts to run. Follow the instructions on the screen.

Connect to PC

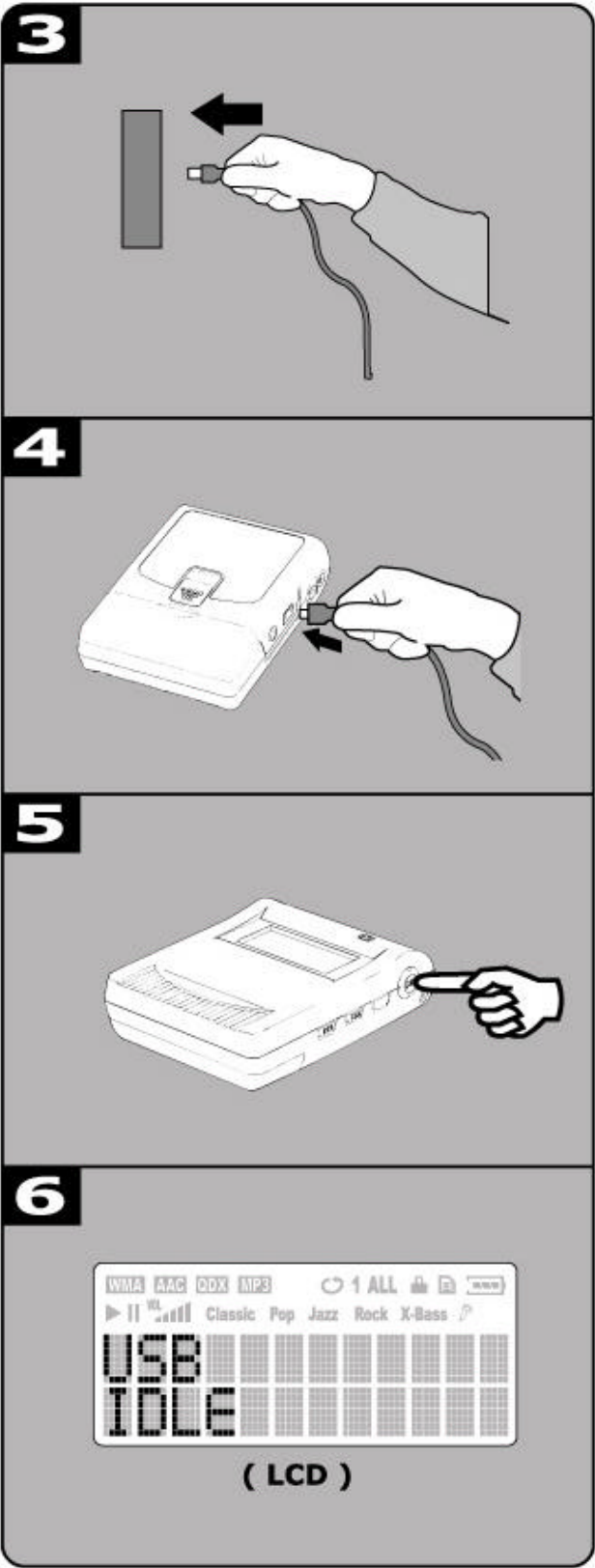

You need not switch off your computer when you connect the unit to the PC since USB is Plug-and-Play.

Connection

- (1) The battery must be in the player.
- (2) Position the PC so that its USB ports can be easily accessed.
(Note : The USB port(s) may be found on the front panel or elsewhere instead of the back panel. Refer to your PC dealer for support if necessary.)
- (3) Plug the flat USB connector of the bundled USB cable to the PC.
- (4) Plug the square connector of the USB cable to the unit.
- (5) Press **Play** button to turn the unit on.
- (6) **USB IDLE** will appear on LCD of the unit.

For Windows Users

- ~~Install and Update~~
- (7) System will detect the new hardware exists in your system and install each of them automatically.
 - (8) Upon the driver installation is completed, run the **Play Update** utility that is now available in the start menu of your Windows system.

Verify Correct Installation of the unit

- (9) When the **Player Update** is completed, the player is ready to use. If you wish to check that whether MP3 Flash Player has properly installed on your system, double-click on **My Computer** icon on the desktop of your Windows.
- (10) You will observe your MP3 Flash Player shows up as **Removable Disk (F:)** and **(G:)** drives in Windows.
- (11) **Removable Disk (F:)** implies the *built-in flash memory* of the MP3 Flash Player.
Removable Disk (G:) drive implies the *Smart Media Card* (if any) inserted into the MP3 Flash Player. In case if Smart Media Card is not present in the player, Removable Disk (G:) will not be accessible.

Connect to PC

For Macintosh Users

- (7) Computer will detect new hardware and install them automatically. **Untitled Disc(F:)** and **(G:)** will appear on desktop.

Untitled Disc (F:) implies the *built-in flash memory* of the MP3 Flash Player.

Untitled Disk (G:) drive implies the *Smart Media Card* inserted into the MP3 Flash Player. In case if Smart Media Card is not present in the player, Untitled Disk (G:) will not be accessible.

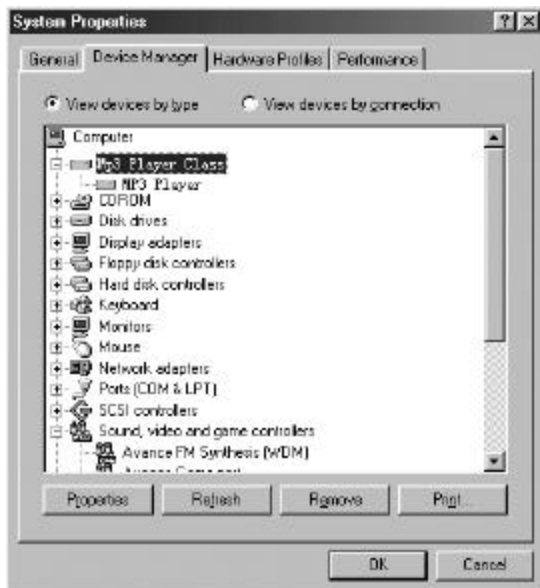

Notice

It is forbidden to unplug the USB cable while the unit is accessing with computer (the LCD displays [USB READING] or [USB WRITING]), because **it may cause serious damage to the unit or computer system.**

It is strongly recommended to unplug the cable **ONLY** while the LCD displays [USB IDLE].

Download MP3 files to the unit

The unit is a handy device for data storage. No any specific software need to upload, download or erase the MP3 or data files. All you do is copy and paste the desired files into the mapped drives that appear on your PC (*Removable Drives show up in **My Computer** or **Desktop***).

Check the connection between PC and the unit is correct and :

For Windows

(If you want to select more than one file, press and hold **Ctrl** key and click on the other files.)

- (b) Select **Copy** in right click menu.
- (c) Double-click on Removable Disk(F:) to open.
- (d) Right-click on blank and select Paste
- (e) Copying window appears.

Do not unplug the unit with your computer while accessing until the unit displays **USB IDLE**

For Macintosh OS

- (c) ~~Drag and drop the file(s) on the **Removable Disk(F:)** icon~~
- (c) Starting to copy MP3 files.

Do not unplug the unit with your computer while accessing until the unit displays **USB IDLE**

- (i) ~~Experienced users may drag and drop the selected~~

Tips

- (ii) To make Removable disk(G:) available, you install one SMC(Smart Media Card) to the expansion slot of the unit.
- (iii) The memory capacity of the removable disk may seem to be different with the actual capacity size of the unit due to different calculate method issue.

Using the player

After download MP3 file(s) into the unit, you can play the MP3 music with you. Ensure that the HOLD switch is not on before you continue, and one available battery must be in the unit.

Power ON / OFF

1. Press the **[PLAY]** button to turn the unit on.
2. To turn the unit off, press and hold the **[STOP]** button for more than about 4 seconds.

Indicators A

1. Battery level indicator
2. Flash card (SMC) indicator
3. Hold mode indicator
4. Repeat mode indicator
5. ID3 Info / Text Info field
6. Text Info field
7. Music Format
8. Equalizer type indicator
9. Recording indicator
10. Repeat mode
11. Volume level

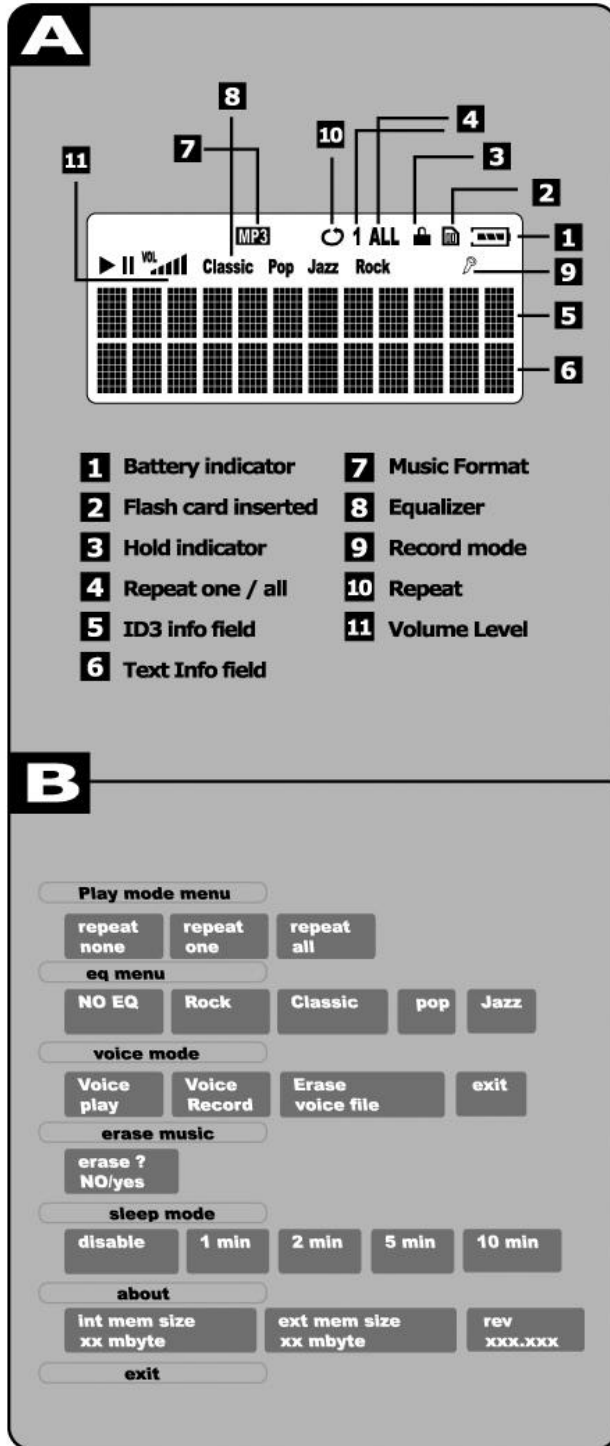

Navigating & Accessing Menus B

Chart **B** shows the navigating menus.

Basic play

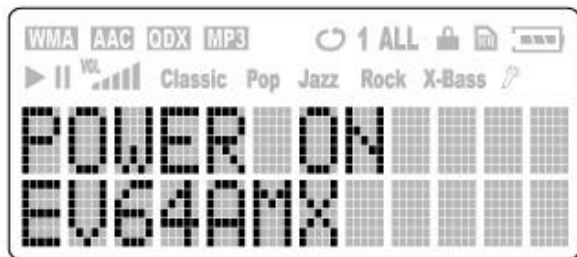

Open Screen



Playing MP3

1. Download MP3 file(s) to the unit
2. Unplug the cable from the unit
3. Connect the stereo earphones to **[PHONES]** jack
4. Press **[Play]** button to turn the unit on
 - a) The unit now power on. MP3 music is ready to play, **Open Screen** displays on LCD
 - b) Press **[SKIP]** button to move to the music you prefer
5. Press **[Play]** button to start to play music
Playing MP3 screen displays on LCD
6. Adjust the volume.
 - (+) : To increase the volume level
 - (-) : To decrease the volume level
7. Skip to next music
If want to skip to next or previous music, press **[SKIP]** button to skip one music.
8. Skip in music
If want to skip in one playing music, press and hold the **[SKIP]** button to skip in the music.

Play settings

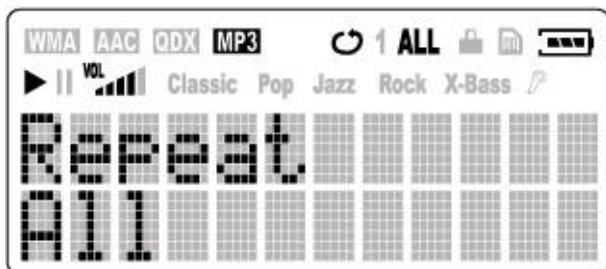

Repeat Screen

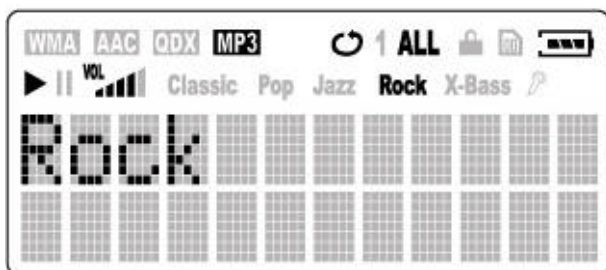

Equalizer Menu

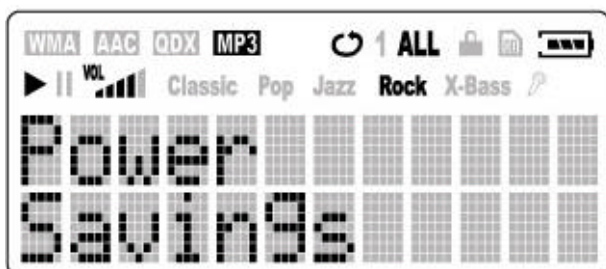

Power Savings

Repeat modes **A**

Users can change play methods in **Play Mode Menu**

1. **Repeat None** (take off all repeat)
2. **Repeat One** (repeat current music)
3. **Repeat All** (repeat all music)

Repeat One or Repeat All selected, the Repeat mode indicator displays on LCD.

Equalizer **B**

In **EQ Menu** there are some kinds of equalizer built in the unit.

1. **No EQ** (Normal)
2. **Rock**
3. **Classic**
4. **Pop**
5. **Jazz**

- a) **No EQ** is the default setting of the player.
- b) Press **[SKIP]** button to change the equalizer type. The selected equalizer active when you select. An Icon appears on LCD display to indicate current equalizer.

Power Savings

The **[Power Savings]** menu is a special function of the unit. The function can power off the unit automatically after the unit is idle to save the battery power.

The options define the power off time after the unit is idle.

There are several options to choose:

1. Disable
2. 1 min
3. 2 min
4. 5 min
5. 10 min

Press **[SKIP]** button to select and press **[MODE]** to confirm the selection.

Record Voice



VOICE RECORDER

Recording voice *A*

The unit can record voice via built-in microphone.

1. Select **[Voice Record]** in **[Voice Mode]** menu and press **[MODE]** button. The unit is ready to record voice.
2. Press **[REC]** button to start one recording.
3. Press **[STOP]** to stop this recording.

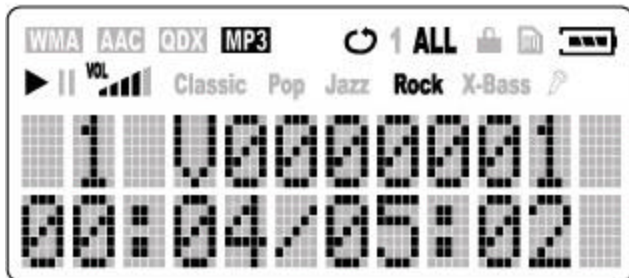

VOICE Playing

Playback voice file *B*

1. Select **[Voice Play]** in **[Voice Mode]** menu and press **[MODE]** button.
2. Latest voice file displays on screen.
To playback the latest voice file, press **[PLAY]** button. Press **[STOP]** to stop.
3. Press **[SKIP]** button to select voice file and press **[PLAY]** button to play.

Erase Music & Voice file(s)

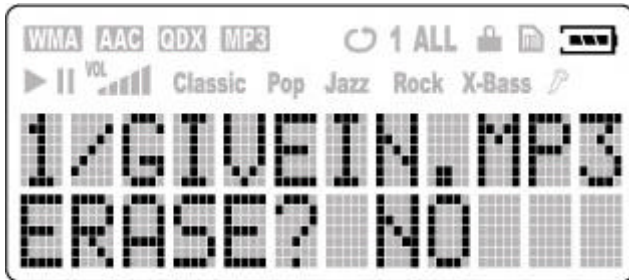

Erase MP3 Files

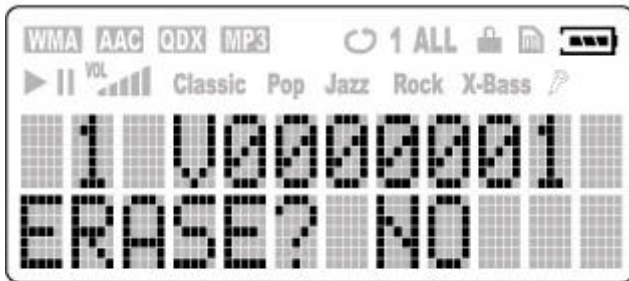

Erase Voice

It is recommended to stop playing when erase music or voice file(s).

1. Stop playing or recording;
- 2.

To Erase MP3 file(s) :

Press the [**MODE**] button and [**SKIP**] button to go to the [**Erase Music**] submenu.

To Erase Voice file(s) :

Press the [**MODE**] button and [**SKIP**] button to go to [**Voice Mode**];

Press [**MODE**] button to enter the submenu and press [**SKIP**] button to [**Erase Voice File**] submenu.

3. Press [**MODE**] button to enter. the [**Erase Music**] or [**Erase Voice File**] submenu.
4. You will be asked if ERASE the listed file,
 - a) **If it is not the file you want to erase**
Keep the answer NO and press [**PLAY**]. Button. The unit will ask you the same question on next music. You may keep pressing [**PLAY**] button until you find the music you want to erase.
 - b) **If it is the file you want to erase**
Press [**SKIP**] button to select YES, press [**PLAY**] to confirm deletion.
5. Press [**MODE**] button to return.

The music and record files can also be erased in computer via USB connection.

Information Submenu

To go to **[About]** Information submenu, press the **[MODE]** button to menu and press **[SKIP]** button to **[ABOUT]** submenu and press **[MODE]** button to enter the submenu.

Information Submenu

- a) Internal memory capacity size
- b) External Memory size
- c) Firmware version

Press **[SKIP]** button to view the information on LCD screen.

Press **[MODE]** button to exit the submenu.

Appendix

A

What is MP3?

MP3 is an acronym for MPEG Layer 3, a type of audio data compression that can reduce digital sound files by a variable 12:1 ratio with virtually no loss in quantity. It allows to store more music into a little memory. Little memory means compact size, so portable MP3 player comes out.

MP3 files can be very small and yet retain a high sound quality. MP3 files usually have the extension .mp3, and can be downloaded from the Internet, or can be legally made for personal use from the audio CDs that you purchased.

Please check if the MP3 file(s) is legal before you start to use.



Illegal to encode MP3 files for trade or sale unless you have the expressed and explicit permission of the copyright owner(s).

MP3 Websites

Through websites, you can download MP3 files either with or without charge and get information about the latest techniques and software related with MP3.

Examples of websites with MP3 content are :

(For Reference use ONLY)

MP3.COM

(<http://www.mp3.com>)

Layer3.org

(<http://www.layer3.org>)

EMusic

(<http://www.emusic.com>)

Songs.com

(<http://www.songs.com>)

Search with 'mp3' topic in search engine for more MP3 related websites and news.

Appendix

B

Cautions

Selection and care of battery

- Alkaline battery is recommended.
- Align the poles (+) and (-) correctly when inserting the batteries.
- Battery play time may be shorter than usual after frequent key operation.
- Remove the battery if you do not intend to use the unit for a long time.
- Do not peel off the covering on battery and do not use if the covering has been peeled off.

Precautions for Listening with the Earphones

- Do not play your earphones at a high volume. Hearing experts advise against continuous extended play.
- If you experience a ringing in your ears, reduce volume or discontinue use.
- Do not use while operating a motorized vehicle. It may create a traffic hazard and is illegal in many areas.
- You should use extreme caution or temporarily discontinue use in potentially hazardous situations.
- Don't turn up the volume so high that you can't hear what's around you.
- Discontinue use if you experience discomfort with the headphones or earphones. Continued use may cause rashes or other allergic reactions.

Handling the Unit

- **No altering or remodeling.**
This can cause malfunctioning.
- **No dropping or strong impacts**
This may damage the unit.
- **Locations to be avoided**
Avoid using or storing the unit in following locations since they can cause malfunctioning.
 1. Bathrooms and other moisture-prone places
 2. Warehouses and other dusty place.
 3. Very hot places near heating appliances, etc.
- **Avoid keeping the unit in places with high humidity, strong magnetic field, or near high heat source(s).**
- Do not leave the unit exposed to direct sunlight for long periods of time

Appendix

C

Software Utility

Upon the driver installation is completed, two software utilities will be installed in PC.

Customer can use the utilities to format or upgrade the unit. Connect to PC and open **Start>Program> Mp3 Player** menu (Windows OS).

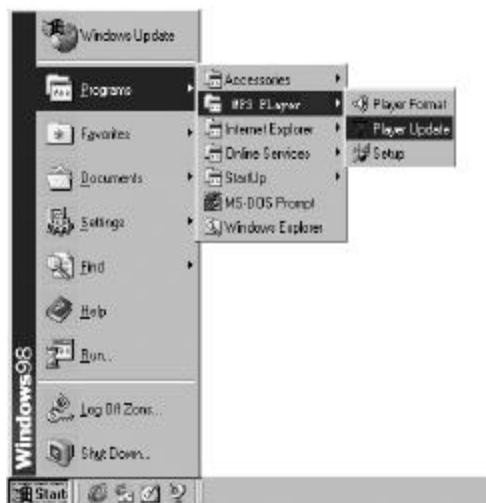

Notice

It is forbidden to unplug the USB cable while the unit is accessing with computer (while the LCD displays [USB READING] or [USB WRITING]), because **it may cause serious damage to the unit or computer system.**

It is strongly recommended to unplug the cable **ONLY** while the LCD displays [USB IDLE].

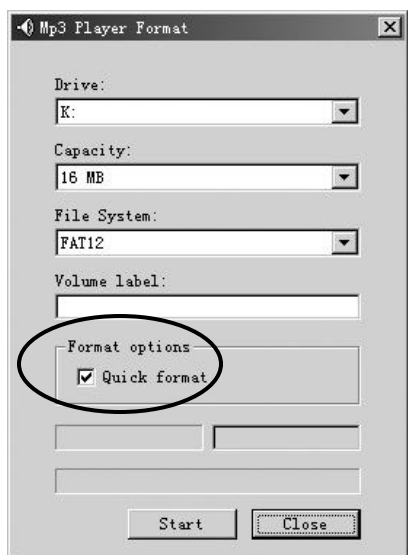

Storage Device Format Utility

User will be able to format the flash memory of the unit through the **MP3 Player Format** utility shown below. The utility can either be initialized through the **Start Menu** or by right clicking on the removable storage device drives in **Windows Explorer**.

Quick format checkbox:

Empty (default): Completely format

Checked : Quick format, not scan for bad sectors.

* Please avoid to use other format utility to format the unit or the Smart Media card.

Firmware Upgrade Utility

The firmware in the player will be able to upgrade through a utility running on your PC. To update the firmware, user needs to run the **MP3 Player Update** utility shown below. This utility can be initialized through the **Start Menu** of Windows.

The **[Quick download]** check box :

Checked (default) : update the firmware and no format the memory

Not checked (Empty) : update the firmware and format the memory. All contents in the flash memory will be lost.

*** If it is to refresh the firmware, please let the check box empty, and upgrade the firmware by same version firmware as current.**

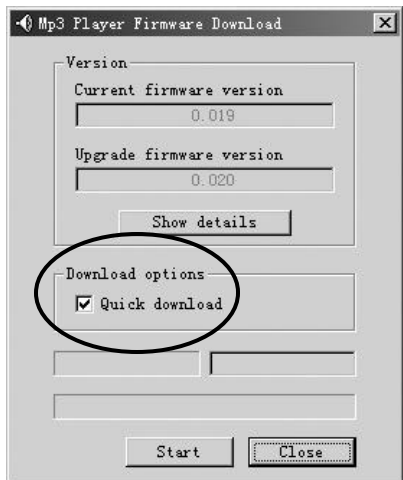

Appendix

D

Technical Specification

PORTABLE MP3 PLAYER EV64AMX

Size(WxHxD)/Weight

- 57 x 74 x 22 mm / 50g (without battery)

Memory

Internal Memory

- 64 MB

Type of removable memory :

- 1 x Smart Media slot
use 16, 32 and 64MB SMC card

Interface

- USB (using standard USB v1.1 cable)

LCD Display

- 1 line x icon & 2 lines x 12 characters LCD

Power

- 1 x AA Alkaline
- 15 hours for MP3/voice playback

Signal to Noise Ratio

- 88 dB

Frequency Response

- 20 Hz ~ 20 KHz

Output

- 20mW (each output)

Harmonic Distortion Output

- 0.05 ~ 0.1%

Equalizer

- 5 presets equalizer

Processor

- 50 MHz DSP

Audio Codec support

- MPEG Audio Layer 3 (MP3)

Firmware

- Flash based. User upgradeable.

Voice Recording

- IMA-ADPCM encoding.
- About 4 hours recording in 64MB Memory player.

*Specifications are subject to change without notice.
Mass and dimensions are approximate.*

Troubleshooting

The player can not power on.

- Is Battery polarity (+) / (-) right?
- Is Battery capacity enough?
(One 1.5 v AA size Alkaline battery is required.)
- Take the battery out and reinstall the battery to reset the unit.

LCD displays 'Power on / Locked ' and power off.

- Unlock the [HOLD] button and try again

The button is not working.

- Is [HOLD] button locked? If it is, Unlock the [HOLD] button and try again
- Take the battery out and reinstall the battery to reset the unit.

There is no audio produced.

- Check the earphone and / or the connection is working normally.
- Check that MP3 files are **NOT** stored in folder(s).
- Take the battery out and reinstall the battery to reset the unit.

Can not download MP3 file(s).

- Is USB connection steady? Observe if the [USB IDLE] displays on LCD of the unit.
- Check and / or replace the battery.
- Is there no free space to download the file?

(Continued on next page)

Reset The Unit

The unit is controlled by microcircuit and software. So, please **RESET the unit** by taking out and reinstalling the battery when the unit stops responding. And if the unit still cannot work, please **REFRESH** the firmware.

Refresh The Firmware

The unit will not work if the built-in software is corrupted. Connect the unit to computer and use [Firmware Upgrade] utility to refresh the software to normal.

Ref. Appendix C : Software Utility

Appendix

D

Troubleshooting

The music skips sometime.

- Check the music file.
- Use [**MP3 Player Format**] utility to format the flash memory (Let the [**Quick format**] check box EMPTY), and download the music again.

Smart Media Card cannot be used in the player.

- Make sure you are using the correct Smart Media Card.
- Insert the card correctly. One SMC icon shall be on LCD.
- Only 3.3V version cards will work in your MP3 Flash Player. 5V version Cards will not function correctly.

If you have a Media Card reader/writer or some other devices using Smart Media, you may have problems reading the Smart Media Card

- Format the Smart Media Card by the '**MP3 Player Format**' utility.

Notice

All contents in the card will be lost after format!
Backup the contents in the card to safe place BEFORE you start to format the card.

Free Manuals Download Website

<http://myh66.com>

<http://usermanuals.us>

<http://www.somanuals.com>

<http://www.4manuals.cc>

<http://www.manual-lib.com>

<http://www.404manual.com>

<http://www.luxmanual.com>

<http://aubethermostatmanual.com>

Golf course search by state

<http://golfingnear.com>

Email search by domain

<http://emailbydomain.com>

Auto manuals search

<http://auto.somanuals.com>

TV manuals search

<http://tv.somanuals.com>