

E1

MANUAL



AM/FM/SHORTWAVE RADIO



E1 AM/FM/Shortwave Radio

FRONT PANEL DESCRIPTION (See page 12)

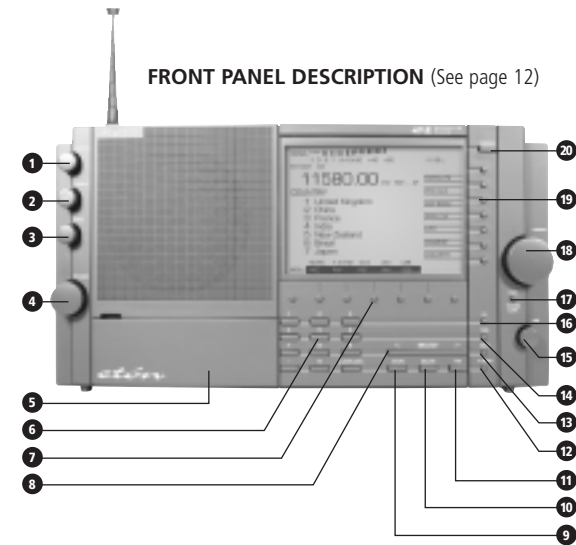

TOP PANEL DESCRIPTION (See page 16)

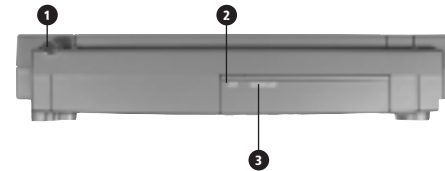

SIDE PANEL DESCRIPTION
(See page 19)

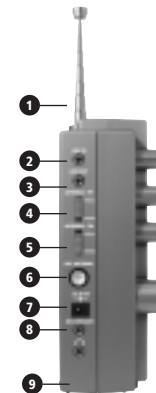

DECLARATION OF CONFORMITY

RESPONSIBLE PARTY : **etón** Corporation
 1015 Corporation Way
 Palo Alto, CA 94303 USA
 (650) 903-3866
 TEL: **etón** Corporation
 TRADE NAME: **etón** Corporation
 MODEL NUMBER: E1

This device complies with Part 15 of the FCC Rules.
 Operation is subject to the following two conditions:
 1. This device may not cause harmful interference, and
 2. This device must accept any interference received,
 including interference that may cause undesired operation.

E1 AM/FM/Shortwave Radio

E1 DISPLAY DESCRIPTION (See page 17)

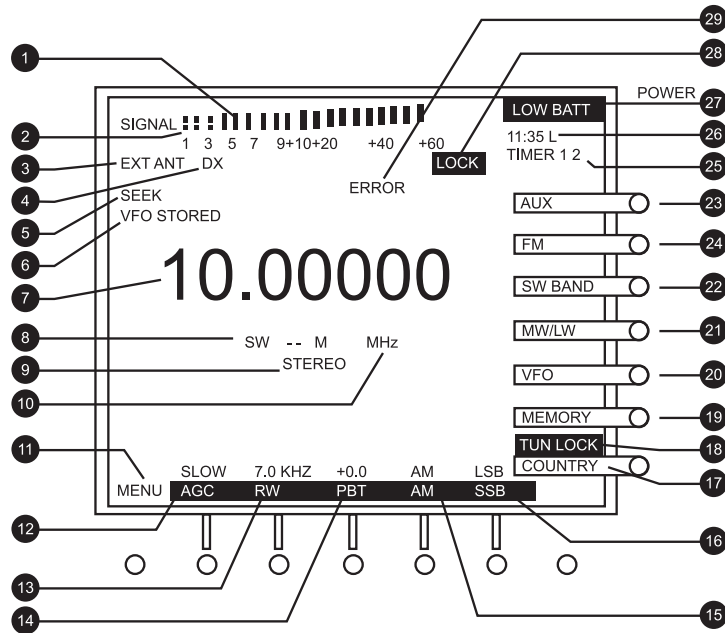

IMPORTANT SAFEGUARDS



An appliance and cart combination should be moved with care. Quick stops, excessive force and uneven surfaces may cause the appliance and cart combination to overturn.



The lightning flash with arrow head symbol, within an equilateral triangle, is intended to alert the user to the presence of uninsulated "dangerous voltage" within the product's enclosure that may be of sufficient magnitude to constitute a risk of electric shock to persons.



An exclamation point within an equilateral triangle is intended to alert the user to the presence of important operating and maintenance (servicing) instructions in the literature accompanying the appliance.

WARNING

WARNING: TO REDUCE THE RISK OF FIRE OR ELECTRIC SHOCK, DO NOT EXPOSE THE APPLIANCE TO RAIN OR MOISTURE. DO NOT OPEN THE CABINET, REFER SERVICING TO QUALIFIED PERSONNEL ONLY.

CAUTION

TO PREVENT ELECTRIC SHOCK, DO NOT USE THE THREE WIRE CORD WITH AN EXTENSION CORD RECEPTACLE OR OTHER OUTLET UNLESS THE BLADES CAN BE FULLY INSERTED TO PREVENT BLADE EXPOSURE.

ATTENTION

POUR PREVENIR LES CHOCS ELECTRIQUES, NE PAS UTILISER CETTE FICHE POLARISEE AVEC UN PROLONGATEUR, UNE PRISE DE COURANT OU UNE AUTRE SORTIE DE COURANT, SAUF SI LES LAMES PEUVENT ETRE INSEREES A FOND SANS EN LAISSER AUCUNE PARTIE A DECOUVERT.

1. Read Instructions - All the safety and operating instructions should be read before the appliance is operated.
2. Retain Instructions - The safety and operating instructions should be retained for future reference.
3. Heed Warnings - All warnings on the appliance should be adhered to.
4. Follow Instructions - All operating and use instructions should be followed.
5. Cleaning - Unplug this appliance from the wall outlet before cleaning. Do not use liquid cleaners or aerosol cleansers. Use a damp cloth for cleaning.
6. Attachments - Do not use attachments that are not recommended by the manufacturer or they may cause hazards.
7. Water and Moisture - Do not use this product near water-for example, near a bathtub, wash bowl, kitchen sink, laundry tub; in a wet basement; or near a swimming pool-and the like.
8. Accessories - Do not place this product on an unstable cart, stand, tripod, bracket, or table. The product may fall, causing serious injury to a child or adult, and serious damage to the product. Any mounting of the product should follow the manufacturer's instructions, and should use a mounting accessory recommended by the manufacturer.
9. A product and cart combination should be moved with care. Quick stops, excessive force, and uneven surfaces may cause the product and cart combination to overturn.
10. Ventilation - Slots and openings in the cabinet are provided for ventilation and to ensure reliable operation of the product and to protect it from overheating, and these openings must not be blocked or covered. The openings should never be blocked or by placing the product on a bed, sofa, rug, or similar surface. This product should not be placed in a built-in installation such as a bookcase or rack unless proper ventilation is provided or the manufacturer's instructions have been adhered to. KEEP CURTAINS AND OTHER FLAMMABLE MATERIALS OUT OF DIRECT CONTACT WITH THE AC ADAPTER.
11. Power Sources - This product should be operated only from the type of power source indicated on the marking label of the supplied AC Adapter. If you are not sure of the type of power supplied to your home, consult your appliance dealer or local power company. For products intended to operate from battery power, or other sources, refer to the operating instructions.
12. Grounding or Polarization - This product may be equipped with a polarized alternating-current line plug (a plug having one blade wider than the other). This plug will fit into the power outlet only one way. This is a safety feature. If you are unable to insert the plug fully into the outlet, try reversing the plug. If the plug should still fail to fit, contact your electrician to replace your obsolete outlet. Do not defeat the safety purpose of the polarized plug. Alternate Warnings- If this product is equipped with a three-wire grounding-type plug, a plug having a third (grounding) pin, the plug will only fit into a grounding-type power outlet. This is a safety feature. If you are unable to insert the plug into the outlet, contact your electrician to replace your obsolete outlet. Do not defeat the safety purpose of the grounding-type plug.
13. Power-Cord Protection - Power supply cords should be routed so that they are not likely to be walked on or pinched by

IMPORTANT SAFEGUARDS continued

- items placed upon or against them, paying particular attention to cords at plugs, convenience receptacles, and the point where they exit from the product.
14. Outdoor Antenna Grounding - If an outside antenna or cable system is connected to the product, be sure the antenna or cable system is grounded so as to provide some protection against voltage surges and built-up static charges. Article 810 of the National Electrical Code, ANSI/NFPA 70, provides information with regard to proper grounding of the mast and supporting structure, grounding of the lead-in wire to an antenna discharge unit, size of grounding conductors, location of antenna-discharge unit, connection to grounding electrodes, and requirements for the grounding electrode. See figure A.
 15. Lightning - For added protection for this product during a lightning storm, or when it is left unattended and unused for long periods of time, unplug the AC adapter from the wall outlet and disconnect the antenna or cable system. This will prevent damage to the product due to lightning and power-line surges.
 16. Power Lines - An outside antenna system should not be located in the vicinity of overhead power lines, other electric light or power circuits, where it can fall into such power lines or circuits. When installing an outside antenna system, extreme care should be taken to keep from touching such power lines or circuits as contact with them may be fatal.
 17. Overloading - Do not overload wall outlets and extension cords or integral convenience receptacles as this can result in a risk of fire or electric shock.
 18. Object and Liquid Entry - Never push objects of any kind into this product through openings as they may touch dangerous voltage points or short-out parts that could result in fire or electric shock. Never spill liquid of any kind on the product.
 19. Servicing - Do not attempt to service this product yourself as opening or removing covers may expose you to dangerous voltage or other hazards. Refer all servicing to qualified service personnel.
 20. Damage Requiring Service - Unplug this product from the wall outlet and refer servicing to qualified service personnel under the following conditions:
 - a. When the AC adapter cord or plug is damaged.
 - b. If liquid has been spilled, or objects have fallen into the product.
 - c. If the AC adapter has been exposed to rain or water.
 - d. If the product does not operate normally by following the operating instructions. Adjust only those controls that are covered by the operating instructions. An improper adjustment may result in damage and will often require extensive work by a qualified technician to restore the product to its normal operation.
 - e. If the product has been dropped or the cabinet has been damaged in any way and
 - f. When the product exhibits a distinct change in performance- this indicates a need for service.
 21. Replacement Parts - When replacement parts are required, be sure the service technician has used replacement parts specified by the manufacturer or have the same characteristics as the original parts. Unauthorized substitutes may result in fire, electric shock or other hazards.
 22. Safety Check - Upon completion of any service or repairs to this product, ask the service technician to perform safety checks to determine that the product is in proper operating condition.
 23. Wall or Ceiling Mounting - The product should be mounted to a wall or ceiling only as recommended by the manufacturer.
 24. Heat - The product should be situated away from heat sources such as radiators, heat registers, stoves, or other products (including amplifiers) that produce heat.

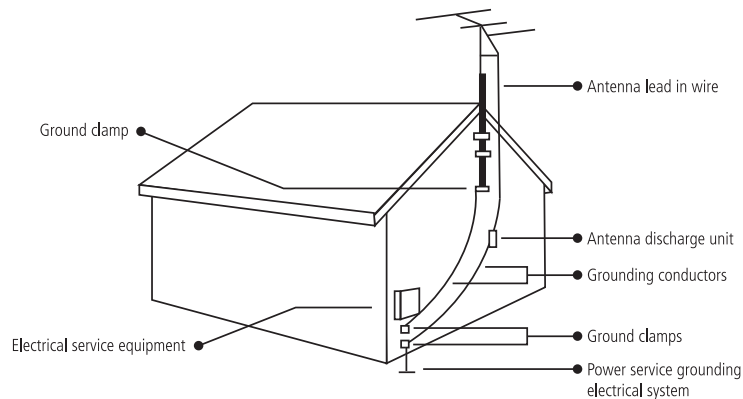

NEC National Electrical Code

ENVIRONMENT



Disposal

According to the European Directive 2002/96/EC all electrical and electronic products must be collected separately by a local collection system. Please act according to your local rules and do not dispose of your old products with your normal household waste.

2 TABLE OF CONTENTS

THANK YOU FOR PURCHASING THE *etón* E1 RECEIVER. THIS RECEIVER HAS BEEN DESIGNED AND MANUFACTURED TO HIGH QUALITY STANDARDS, AND WILL PROVIDE RELIABLE OPERATION FOR MANY YEARS. PLEASE CAREFULLY READ THE OWNER'S MANUAL IN ORDER TO TAKE ADVANTAGE OF THE MANY INTERESTING FEATURES THAT WILL PROVIDE ENJOYABLE LISTENING TO RADIO BROADCASTS AROUND THE WORLD.

IMPORTANT SAFEGUARDS p.3

TABLE OF CONTENTS p.5

GENERAL DESCRIPTION p.7

POWER SUPPLY p.7

- AC ADAPTER and EXTERNAL DC POWERING
- BATTERY INSTALLATION
- BATTERY OPERATION
- BATTERY CONDITION

INSTALLATION p.9

- UNPACKING
- LOCATION
- FIXED INSTALLATION
- PORTABLE OPERATION
- ANTENNA REQUIREMENTS
- VIEWING ANGLE
- INSTALLATION DIAGRAM

E1 FRONT PANEL DESCRIPTION p.12

TOP PANEL DESCRIPTION p.16

E1 DISPLAY DESCRIPTION p.17

SIDE PANEL DESCRIPTION p.19

GETTING STARTED p.20

- GENERAL OPERATING INFORMATION
- FIRST STEPS
- DIRECT FREQUENCY ENTRY
- SHORTWAVE 'METER' BAND DESIGNATOR ENTRY
- FREQUENCY RESOLUTION
- FRONT PANEL LOCK (UNLOCK)
- AM SYNCHRONOUS OPERATION
- SSB OPERATION
- PASSBAND TUNING
- FM OPERATION
- AGC OPERATION
- BEEP TONES

MEMORY FUNCTIONS p.25

- MEMORY DESCRIPTION
- THE MEMORY DISPLAY
- STORING A MEMORY CHANNEL
- RECALLING A MEMORY CHANNEL

- DELETING A MEMORY CHANNEL

COUNTRY FUNCTIONS p.27

- COUNTRY DESCRIPTION
- THE COUNTRY DISPLAY
- STORING A COUNTRY CHANNEL
- RECALLING A COUNTRY CHANNEL
- DELETING A COUNTRY CHANNEL
- CHANGING OR ADDING COUNTRY NAMES

E1 MENUS p.30

- MAIN MENU
- RADIO SETTINGS
- AUDIO SETTINGS
- SET CLOCKS
- CLOCK MODES
- TIMERS
- TIMER 1 ENABLE / DISABLE
- TIMER 2 ENABLE / DISABLE
- LOCAL / GMT TIME SELECT

SEEK FUNCTION p.39

- DESCRIPTION
- VFO MODE
- MEMORY & COUNTRY MODE

T.SCAN FUNCTION p.40

- DESCRIPTION
- MARKING CHANNELS FOR T.SCAN
- UNMARKING T.SCAN CHANNELS
- SELECTING THE SCAN STOP METHOD
- INITIATING AND STOPPING THE T.SCAN

CLOCK AND TIMER FUNCTIONS p.41

- TIME DISPLAY
- SETTING 24 HOUR CLOCKS AUTOMATICALLY
- SETTING THE 24 HOUR CLOCKS MANUALLY
- TIMER OPERATION
- SETTING TIMER ON/OFF TIMES
- SETTING A WAKE OR SLEEP TIMER
- SETTING TIMER MEMORY CHANNELS
- ENABLING/DISABLING TIMER OPERATION

SPECIAL USE FEATURES AND FUNCTIONS p.45

- LOCK ALL ENTRY TO KEYPAD
- BROADCAST BAND TUNING STEP SIZE
- DELETE ALL MEMORY OR COUNTRY CHANNELS
- DELETE ALL MEMORY AND COUNTRY CHANNELS
- DISPLAY LIGHTING

TABLE OF CONTENTS *continued*

QUICK REFERENCE GUIDE p.48

GLOSSARY OF TERMS p.51

TROUBLESHOOTING p.52

SERVICE INFORMATION p.53

ONE YEAR LIMITED WARRANTY p.53

APPENDIX p.54

• **UNDERSTANDING SHORTWAVE BANDS** p.54

- WHAT IS SHORTWAVE?
- SOME BASIC RULES OF THUMB
- WHAT ARE BANDS?
- A HELPFUL ANALOGY ABOUT BANDS
- DAY BANDS v s. NIGHT BANDS
- SUNSET AND SUNRISE
- DAYTIME LISTENING
- EVENING/NIGHT LISTENING
- SHORTWAVE DIRECTORY
- SHORTWAVE ANTENNAS
- FULL-SIZED PASSIVE SHORTWAVE ANTENNAS
- ACTIVE SHORTWAVE ANTENNAS
- SHORTWAVE ANTENNAS FOR USE ON BOATS
- LONG-WIRE SHORTWAVE ANTENNAS
- AM ANTENNAS
- FINDING ANTENNAS
- TIME STATIONS
- GETTING STARTED WITH SINGLE SIDEBAND (SSB)
- WEATHER FAX FREQUENCIES
- MORE INFORMATION ABOUT SSB
- MONTHLY MAGAZINES WITH SSB RELATED INFO
- TIME STATIONS (not SSB)

• **ETON E1 QUICK GUIDE** p.58

- INTRODUCTION
- SET-UP INFORMATION
- TUNING-IN FM AND MW STATIONS
- USING DIRECT FREQUENCY ENTRY
- USING THE SEEK FEATURE
- LISTENING TO SHORTWAVE STATIONS

- CHOOSING THE BEST SHORTWAVE BAND
- GETTING INTO A SHORTWAVE BAND
- TUNING AROUND IN A SHORTWAVE BAND
- STORING FREQUENCIES INTO MEMORY
- ACCESSING WHAT YOU HAVE STORED INTO MEMORY
- DELETING THE CONTENTS OF A MEMORY
- SETTING THE CLOCK TO YOUR LOCAL TIME
- SETTING THE DISPLAY FOR LOCAL OR GMT TIME
- SETTING THE TIMER AS AN ALARM CLOCK
- USING TIMER 1 AS A WAKE-UP TIMER
- USING TIMER 2 AS A SLEEP TIMER
- TO ENABLE OR DISABLE THE TIMERS

SPECIFICATIONS p.62

BLOCK DIAGRAM p.64

GENERAL DESCRIPTION

The *eton* E1 is a microprocessor controlled, synthesized, world band receiver with continuous coverage capability from 100 kHz through 30 MHz and from 76 MHz through 108 MHz which includes the AM broadcast and shortwave bands as well as the FM broadcast band. The receiver offers excellent sensitivity, selectivity, dynamic range, and features that permit easy tuning of desired stations. Conveniently located front panel controls allow for rapid operator programming and ease of use. The units can be operated from either the supplied AC ADAPTER, an external 7 to 14 VDC source, or from four "D" cell batteries (not supplied) for portable operation. A low battery voltage indication is displayed when that condition exists.

Three electronically switched IF filters are provided to provide optimum interference rejection for each mode. The front panel dot matrix liquid crystal display provides feedback of the current status of the receiver. The seven digit frequency display provides resolution to 10 Hz in the AM broadcast and Shortwave bands. Resolution to 20 kHz is displayed in the FM broadcast band. Backlighting of the display is selectable by a "LIGHT" key on top of the cabinet. To prolong battery life with internal battery operation, the backlighting automatically turns off after a short delay following a function change or retuning of the receiver unless it is specifically locked in the ON mode.

When the receiver is turned off, the display provides either the Local time or Greenwich Mean time (GMT), selectable in either the off or on state by the user. Reception modes include Single Sideband (LSB & USB) and AM in the Shortwave, MW (AM broadcast) and LW bands. For the LW, Shortwave and MW bands, a selectable sideband synchronous detector (SYNC) allows for enhanced AM reception by eliminating or reducing distortion due to fading signals or a strong adjacent signal. During FM broadcast use, stereo reception is available

POWER SUPPLY

AC ADAPTER and EXTERNAL DC POWERING

The *eton* E1 receiver is supplied with an AC ADAPTER. The AC ADAPTER is designed to be plugged into a wall outlet that supplies AC power, or another source of external filtered DC power between 7 and 12 VDC may be used.

Connect the output connector of the AC adapter, or other power source, to the 9 VDC, 1 amp connector on the side of the receiver.

through the use of headphones, or by connecting the line out jack to an external stereo system.

Other built-in reception aids include selectable slow, fast, or automatic AGC time constant, scanning of memory channels, either by time or by carrier presence, passband tuning and squelch as well as treble and bass controls. Two independent, real time clocks provide Local or GMT time selection. Also provided are a two event timer, a SLEEP timer, and a SNOOZE mode.

A programmable memory area allows for 1700 independent receiver set up memories. The first 500 of these memory channels allow names to be attached to the frequencies and modes stored. The remaining 1200 memory channels allow frequencies to be stored by country. There are 111 country names factory stored in this bank of memory with 10 memory channels available per country and 90 memory channels remaining with no country assigned. These country names can be modified or added to by the user. These memories do not require battery backup and are thus unaffected by power interruptions.

All parameters associated with a particular memory channel are stored including the frequency, mode, bandwidth, passband tuning setting, fast, slow, or automatic AGC and synchronous detector state. These memory channels may be accessed manually or through a time scan with each channel monitored for a 5 second period, or carrier presence.

If batteries are installed and external power is lost, the receiver will continue to operate on battery power even with the DC plug inserted. If this occurs, the receiver will alert the user with a POWER LOSS indication, and with a POWER LOSS beep if the POWER LOSS beep feature is enabled. More details concerning power loss can be found on page 20, paragraph 27b.

POWER SUPPLY continued

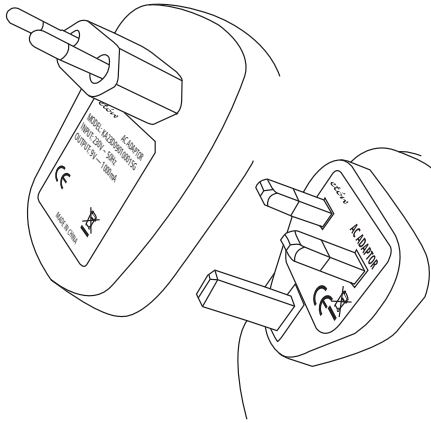

AC ADAPTER

Keep curtains and other flammable materials out of direct contact with the AC ADAPTER to avoid overheating.

BATTERY INSTALLATION

The *etón* E1 receiver is also designed to operate from four "D" cell batteries (not supplied). NOTE: Check the batteries periodically for leakage. IF UNIT IS TO BE STORED OR OTHERWISE NOT USED FOR AN EXTENDED PERIOD OF TIME, REMOVE THE BATTERIES TO PREVENT CORROSION AND POSSIBLE DAMAGE TO THE RECEIVER. Damage caused by battery acid leakage is not covered under the warranty.

- (1) Position the receiver with the front panel towards you.
- (2) Open the battery access door located at the lower left corner of the front panel. (Shown as #5 in the front panel drawing.)
- (3) Inside you will find an additional door as shown in the following illustration.

Battery Access Panel Simultaneously press down and pull outward to open



Remove this door by pressing down and pulling outward on the "OPEN" tab.

- (4) Insert the first of four "D" sized batteries into the battery opening with the plus end of the battery to your left. See the following illustration.

Insert battery with "+" end to the left, and slide battery to the right



- (5) Slide the battery to the right and continue in this manner until all four batteries are installed. Replace the inner door and close the outer door.

BATTERY OPERATION

The *etón* E1 receiver does not rely on the batteries for retention of memory channels. However, to insure that clocks are maintained following the loss of AC power and battery removal, the receiver must first be connected to a source of AC power or have batteries installed. Clock settings are maintained for a time period of approximately 10 minutes after all power is removed. New batteries should be installed before this time period elapses or clock settings will be lost.

POWER SUPPLY continued

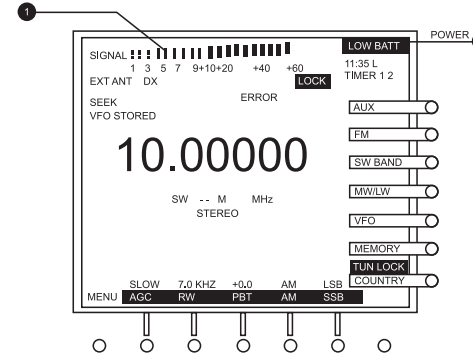

BATTERY CONDITION

Battery condition can be observed when the unit is turned on or if the 'LIGHT' button is pressed if no AC ADAPTER is connected to the receiver. When the POWER key is pressed, or when the 'LIGHT' button is pressed, a screen will be observed similar to the following illustration during the first two seconds after depression.

INSTALLATION

UNPACKING

Carefully remove the *etón* E1 receiver and included AC ADAPTER wall transformer from the shipping carton and examine them for evidence of damage. If any damage is noted, immediately contact the transportation company responsible for delivery, or return the unit to the dealer from whom it was purchased. Keep the shipping carton and all packing material for the transportation company to inspect. The original carton and packing material should be retained for repackaging should it be necessary to return the receiver. Inspect the packing material for any accessories or printed material before storing the box. Locate the registration card, fill it out, and immediately return it to *etón* to insure registration and validation of warranty.

LOCATION

For fixed locations, the *etón* E1 receiver should be operated from the AC ADAPTER. Keep curtains and other flammable material away from direct contact with the AC ADAPTER to avoid overheating the transformer which could result in failure or fire.

FIXED INSTALLATION

After unpacking the unit, connect the antenna system to the 'EXT ANTENNA' input, or select the INTERNAL antenna and extend the built in telescopic antenna. Plug the AC ADAPTER into a source of AC power. Refer to the Figure 1 on page 12 for the diagram of a typical fixed installation.

After that time, the normal E1 display will be observed.

- (1) Battery Condition Graph - This bar graph shows the relative charge of the batteries installed in the receiver. You will note that on the left, there is an "EMPTY" notation and on the right is a "FULL" notation. A fully charged set of batteries will produce a graph reaching the "FULL" notation, and as the batteries discharge, the graph will extend only slightly passed the "EMPTY" notation.
- (2) LOW BATT - If this flashing reversed video indicator is observed, the batteries are too low for satisfactory operation and must be replaced.

Note: Regardless of battery condition, neither items 1 or 2 above will be observed if the unit is connected to the AC ADAPTER. If the AC ADAPTER is not connected, the condition graph will only be observed upon power up or with depression of the 'LIGHT' button.

PORTABLE OPERATION

For use in a portable environment, the *etón* E1 receiver is operated from four (4) internally mounted "D" cell batteries. These batteries are not supplied and must be installed prior to portable operation of the receiver. See BATTERY INSTALLATION section on page 9 of this manual. For longest battery life, alkaline batteries are recommended for this product. **NOTE: REMOVE THE BATTERIES IF THE RECEIVER IS TO BE STORED OR OTHERWISE NOT OPERATED FOR AN EXTENDED PERIOD OF TIME TO AVOID DAMAGE TO THE *etón* E1 DUE TO POSSIBLE BATTERY LEAKAGE OR CORROSION EFFECTS.** The *etón* E1 receiver does not rely on the batteries for retention of memory channels. If power is lost, clock settings are maintained for a period of approximately 10 minutes to allow time to install new batteries. As long as good batteries are installed in the unit, the clocks are maintained regardless of whether there is external power applied or not.

ANTENNA REQUIREMENTS

(Refer to Figure 1, page 12)

The *etón* E1 receiver incorporates side panel switches to select between the internal telescopic antenna and various types of external antennas. The built-in telescopic antenna is available for use on all bands. A PAL type antenna connector, also located on the left side panel, is provided for external antennas for LF, MW, SW (HF is used to designate these ranges) and FM bands. A PN

INSTALLATION continued

278-265B adapter, sold by Radio Shack, Maplin Electronic Supplies (www.maplin.com) or an equivalent adapter, will adapt a female type F connection to the PAL-TO-F type connector on the *etón* E1.

RIGHT SIDE AND REAR VIEWS

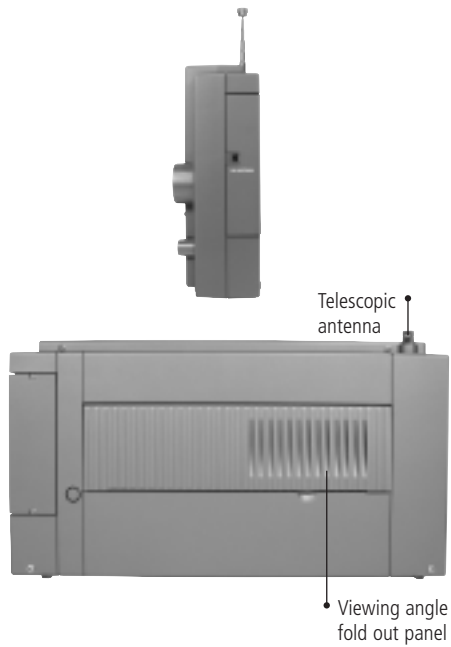

Antennas such as dipoles, trap dipoles, verticals and long wires will provide the best results on the LF, MW, and SW bands. The type to use for best results depends upon the desired receiving frequency, and will normally provide adequate results on the FM band. Outside TV antennas, folded dipoles, or coaxial antennas will provide the best results for reception of the FM broadcast band, but will not provide optimum results on LF, MW and SW bands.

Connect the outside antenna feed to the "EXT. ANTENNA" jack located on the left side panel. The best antenna for any of the previously mentioned frequency bands will depend on the frequency range and time of day for the particular signal in question. Refer to publications such as the ARRL Handbook or ARRL Antenna Manual (available in most public libraries) for help on selection and/or construction of the antennas mentioned above.

VIEWING ANGLE

On the back of the receiver is a hinged panel. This panel can be pulled out, and the receiver tilted back on it to provide a convenient viewing angle when operating the *etón* E1 receiver on a table or similar surface in front of you, as shown below.

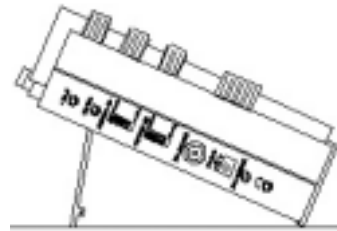

VIEWING ANGLE OPTION

When viewing at a new angle, it may be desirable to readjust the LCD contrast control located behind the pull down door. See page 13, item 5.

INSTALLATION continued

FIGURE 1: E1 INSTALLATION DIAGRAM

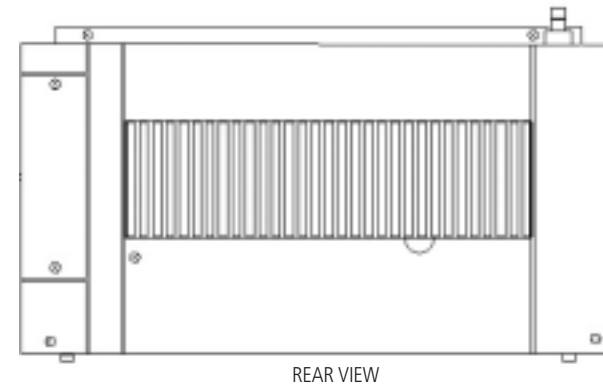
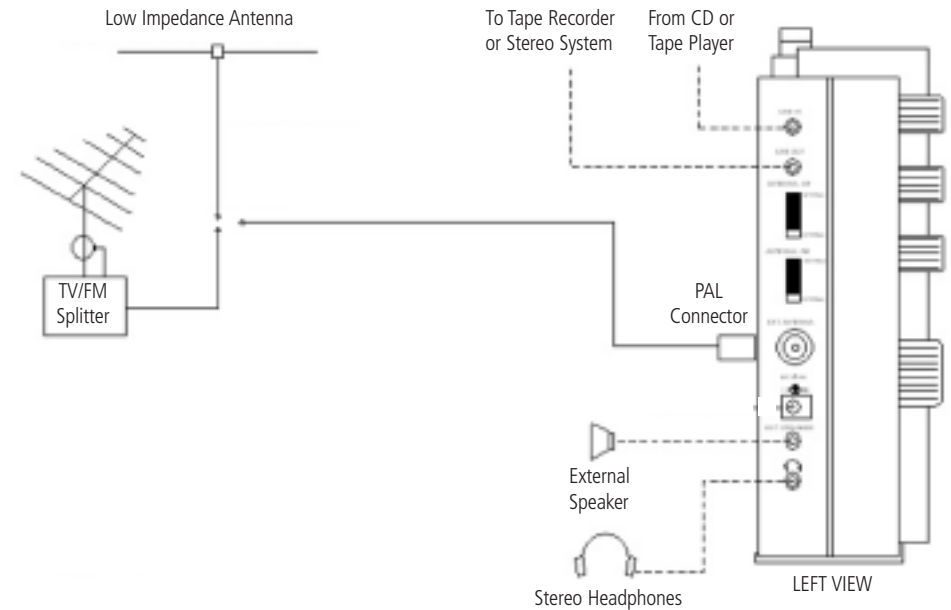

E1 FRONT PANEL DESCRIPTION

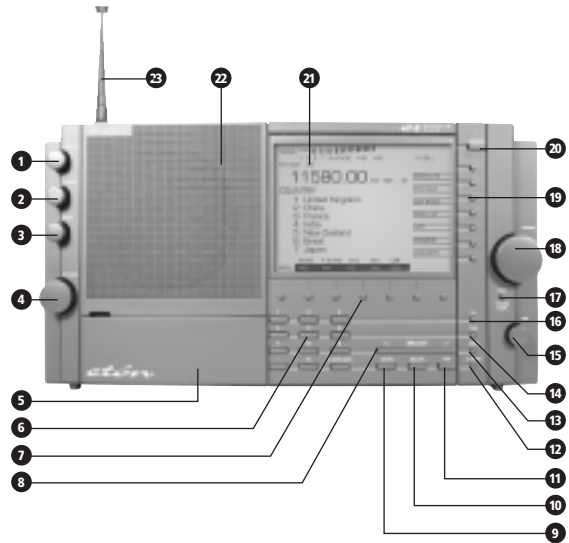

1. Squelch

This control allows muting of the receiver's audio when no signals are present. Adjust the control until background noise just disappears when no signal is being received. An indicator is provided on the display directly under the signal strength display to show how the squelch is set relative to received signal strength. (See the display description starting on page 18). Squelch also sets the threshold for carrier scan stop. Muting can be disabled in AUDIO SETTINGS menu, Item 4. However, carrier stop threshold will be controlled by the Squelch control regardless of whether or not muting has been disabled.

2. Treble

This control adjusts the audio frequency response at the high end of the audio spectrum. Adjust clockwise for more treble response.

3. Bass

This control adjusts the audio frequency response at the low end of the audio spectrum. Adjust clockwise for more bass response.

4. Volume

With the receiver on, adjust this control clockwise to increase the audio level from the receiver's speaker or from headphones. Be certain to set the volume setting at the desired level for TIMER use.

5. Access Door

Provides access to the battery access panel, to the microprocessor Reset button access hole, to the Display

Contrast Knob, and to the Factory Programming Connector. The Factory Programming Connector should be used only by a factory authorized service center. The Display Contrast Knob should be adjusted for best display contrast from the normal viewing position. The Reset button "reboots" the microprocessor and should be pressed using a straightened paperclip in the unlikely event that the receiver exhibits erratic operation, "freezes", or displays a flashing "UNLOCK" on the display. (See the following diagram for the location of these items).

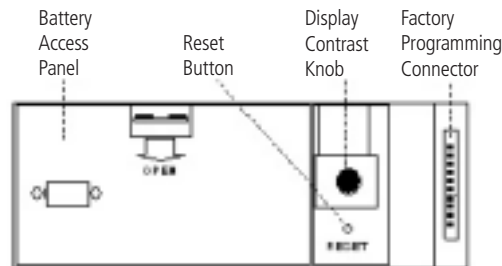

6. Direct- Key-Input

Numeric Keys - Keys 0 thru 9 plus the '.' key are used to make direct numeric entries of frequencies, memory channel numbers, meter band designators, menu selections, and timer settings. CLEAR / LOCK - Press this key to clear an incorrectly entered frequency or other value. Pressing and holding this key for three seconds will cause the receiver to be locked in its present configuration. All front panel key controls as well as the 'TUNING'

E1 FRONT PANEL DESCRIPTION continued

knob will be ineffective, and "LOCK" and "TUN LOCK" will appear on the LCD display. To return to normal operating mode, once again press the 'CLEAR/LOCK' key for three seconds. This control can also be used when the receiver is turned off. Press 'CLEAR/LOCK' for 3 seconds. A message will appear confirming lock. If power is then pressed, a "Press CLEAR/LOCK for 3 seconds to unlock" message will appear. The user must perform this action before the 'POWER' key will allow power up. From either MEMORY or COUNTRY modes. Note that VFO (Variable Frequency Oscillator) is a register used to store the frequency to which the main 'TUNING' control is set. Turning the 'TUNING' control will change this frequency.

7. FM / LW / MW / SW Mode - Function Softkeys

The function of each of these softkeys is shown along the bottom edge of the display when the receiver is in the ON state. From left to right their functions when a menu is not displayed are as follows:

MENU - Pressing this softkey displays the first of several menus used for setting clocks, timers and various other receiver functions. Each additional press advances to another menu page.

AGC - Pressing this softkey will toggle the AGC decay time between fast, slow, and auto in all modes but FM. When in FM mode, there will be no display function shown for this softkey.

BW - Press repeatedly to scroll through the three available IF bandwidths of 7.0, 4.0, and 2.3 kHz in all modes but FM. When in the FM mode, there will be no display function shown for this softkey.

PBT - Pressing this softkey enables/disables the function of the PBT (passband tuning) knob in all modes except FM. The displacement in kHz of the IF passband relative to its nominal position is shown on the display directly above the PBT softkey when it is enabled. When in FM mode, there will be no display function shown for this softkey.

AM - Press to select AM (amplitude modulation) mode. When AM mode is selected, a second press of the softkey selects AM synchronous detection mode (AM SYNC). Repeated depressions of this softkey will cycle the synchronous detection mode on and off. When in FM mode, there will be no display function shown for this softkey.

SSB - Press to select SSB (Single Sideband) mode. Once SSB mode is selected, repeatedly pressing the SSB softkey will cycle between upper sideband (USB) and lower

sideband (LSB). When AM synchronous detection mode is first selected using the 'AM' softkey, pressing the 'SSB' used to store the frequency to which the main 'TUNING' control is set. Turning the 'TUNING' control will change this frequency.

Pressing 'TUNE' transfers the frequency last listened to while in the MEMORY or COUNTRY modes to the VFO, along with the current associated function parameters. This allows for fine tuning of and around the transferred frequency or modifying its parameters. When 'TUNE' is pressed, "VFO STORED" will briefly appear on the display. This softkey is functional in MEMORY and COUNTRY modes only.

8. < SELECT >

In VFO mode, pressing the '<' or '>' ends of this key will cause the frequency to increment or decrement in 5 kHz steps on LF and SW bands, in either 9 or 10 kHz steps on the MW (AM broadcast) band depending on a menu setting, and in 100 kHz steps on the FM band. When in MEMORY or COUNTRY modes, each press of the '<' or '>' ends of the key causes the display to decrement or increment respectively one memory page. When in MEMORY or COUNTRY modes, holding down the '<' or '>' will cause the unit to scroll through the MEMORY or COUNTRY pages. When programming in MEMORY mode, pressing '<' or '>' moves the cursor left or right respectively for entering the names for stored frequencies.

9. STORE

This key is used to store various pieces of information including setting the Local and GMT clocks, setting parameters and labels in the 500 MEMORY channels, and saving parameters in the 1200 COUNTRY channels.

10. DELETE

Use this key to delete entries in the 500 MEMORY or 1200 COUNTRY.

11. TAG

Pressing this key adds (or removes) a tag shown as a "T" on MEMORY and COUNTRY displays from any of the MEMORY and COUNTRY for selective scanning.

12. T. SCAN

Used to initiate or stop a scan of MEMORY or COUNTRY channels marked with a "T" tag.

13. SEEK

Pressing the SEEK key will cause the frequency to increment in 5 kHz steps on LW, and SW modes, 9 or 10 kHz steps in MW, depending on the setting of item 4 in the

E1 FRONT PANEL DESCRIPTION continued

"RADIO SETTINGS" menu, and 200 kHz steps on FM mode, until a signal is encountered that is stronger than the SQUELCH setting. While SEEK is engaged, the word "SEEK" will appear on the display.

14. TIME

Pressing the 'TIME' key will cause the TIMER 1 screen to appear on the display, allowing TIMER 1 to be enabled or disabled. Pressing it a second time will cause the TIMER 2 screen to appear, allowing it also to be enabled or disabled. Pressing the TIME key the third time brings up the "CLOCKS" menu which will allow selection of GMT or LOCAL time for the time display. Pressing the 'TIME' key the fourth time will return the display to the VFO, MEMORY or COUNTRY screens, depending upon which of these screens was being displayed when the 'TIME' key was pressed the first time. The receiver displays the time when in the off mode, and when in this state, pressing the 'TIME' key will toggle the display between Local and GMT time.

15. PBT

The PBT (PassBand Tuning) knob varies the IF passband of the receiver plus or minus 2 kHz relative to the detector beat frequency oscillator (BFO) in SSB mode, and relative to the displayed frequency when on AM mode. This is particularly useful in reducing or eliminating interference to the desired signal from nearby signals. The PBT knob will be ineffective unless the 'PBT' softkey beneath the display is pressed. The amount of IF frequency displacement from nominal will be displayed directly above the 'PBT' function label on the display. PBT tuning is not available in FM or AUX modes. In MEMORY or COUNTRY modes, the stored PBT value will always be recalled and "MEM" will be indicated above the 'PBT' softkey until changed.

16. DX

The 'DX' softkey turns on or off an RF preamplifier which is useful in improving the readability of very weak signals, especially when using the built in telescopic antenna or other short antennas. When the preamplifier is enabled, "DX" will appear on the display. When using long antennas or when the receiver is in close proximity to very strong broadcast transmitters, the receiver will perform best with 'DX' off. The DX function is not available in AUX mode. Note that battery life will be reduced somewhat if DX is enabled during portable operation.

17. FAST / TUNING LOCK

Repeatedly pressing the FAST / TUNING LOCK key cycles through the available tuning rates for the current operating mode, as explained in more detail under "Tuning" which follows. Holding down the 'FAST / TUNING LOCK'

key for approximately 2 seconds will lock out the 'TUNING' knob and will cause "TUN LOCK" appear on the display. Depressing the key again for approximately 2 seconds will unlock the 'TUNING' knob and "TUN LOCK" will disappear from the display.

18. Tuning

The 'TUNING' knob is the primary tuning control of the E1 receiver. In VFO mode, clockwise rotation of the dial increases frequency and counterclockwise rotation decreases frequency. The rate at which frequency is increased or decreased is determined by the band being tuned and by pressing the 'FAST/TUNING LOCK' key on a given band. In VFO mode, the 'FAST/TUNING LOCK' key also changes the displayed frequency resolution. In MEMORY mode, the 'TUNING' knob scrolls through the 500 MEMORY channels one at a time. If the 'FAST/TUNING LOCK' key is pressed, "FAST" appears on the display and the 'TUNING' control scrolls through the 500 MEMORY channels 10 at a time as long as the 'TUNING' knob is being turned. If the 'TUNING' knob is not moved for three seconds, the "FAST" on the display will disappear and the 'TUNING' knob will revert to tuning MEMORY channels one at a time.

The 'TUNING' knob is also used when programming in MEMORY mode to scroll through all available alphanumeric characters when entering names for each MEMORY entry.

In COUNTRY mode, the 'TUNING' knob scrolls through COUNTRY memory channels one at a time. If the 'FAST/TUNING LOCK' key is pressed, "FAST" appears on the display and the 'TUNING' knob scrolls through the available countries one country at a time with 10 memory channels being available per country.

In SW BAND mode, the 'TUNING' control will scroll through the available shortwave broadcast bands from 120 meters through 11 meters.

19. Mode Softkeys

The purpose of each of these softkeys is shown along the right edge of the display when the receiver is in the ON state. From top to bottom their descriptions are as follows:

FM / AUX - Pressing this softkey toggles between the FM broadcast band and the AUX function. The selected function will be in reverse video. The first press of this softkey selects the FM broadcast band (76.0 - 90.0 MHz or 87.0 -108.0 MHz) and causes the label for this key to appear as " FM / AUX ". When in FM mode, only the MENU function softkey along the bottom of the display

E1 FRONT PANEL DESCRIPTION continued

will be active. Pressing this softkey a second time toggles to the AUX function which causes the softkey label to appear as " FM / AUX ". The AUX function allows stereo audio fed into the LINE IN connector on the side panel to be fed to the internal speaker or to headphones plugged into the stereo headphone jack, which is also on the side panel. The 'VOLUME', 'TREBLE', and 'BASS' controls will be active in this mode.

SW BAND - Pressing the 'SW BAND' softkey once enables the shortwave band (1.800 - 30.000 MHz). The MW / LW - Repeatedly pressing the 'MW / LW' softkey toggles between the LW band (100 - 499.99 kHz) and the MW band (500 - 1799.99 kHz).

VFO - This softkey returns to the VFO mode from MEMORY or COUNTRY modes. The frequency displayed will be the same as the frequency last selected in VFO mode before MEMORY or COUNTRY modes were selected.

MEMORY - Selects MEMORY mode which allows programming or listening to the programmed contents of memory channels 1 through 500.

COUNTRY - Selects COUNTRY mode which allows programming or listening to the contents of memory channels 501 through 1700. These 1200 memory channels are divided among 111 countries from Afghanistan to Yugoslavia with 10 memory channels per country, and with 90 memory channels remaining with no country assigned. Display will appear as "BAND ". Pressing the 'SW BAND' softkey again once SW has been selected will cause the "--" portion of "SW -- M" on the display to flash and the display will show " SW BAND " for approximately SW BAND 2 seconds. During this 2 second interval, entering the meter designator for the desired meter band will cause the receiver to go to the low end of the frequency range for the desired meter band. During this 2 second interval one can also scroll through the available SW bands using the 'TUNING' knob or the '< SELECT >' key. Each keypress or TUNING input resets the two second timer. The frequency ranges for the defined meter shortwave bands are as shown in the 'Shortwave Band Designators' table which follows.

Shortwave Band Designators

Band	Low	High Freq
120 Meter	2300 kHz	2500 kHz
90 Meter	3200 kHz	3400 kHz
75 Meter	3900 kHz	4000 kHz
60 Meter	4750 kHz	5060 kHz
49 Meter	5800 kHz	6200 kHz
41 Meter	7100 kHz	7600 kHz
31 Meter	9500 kHz	9900 kHz
25 Meter	11,600 kHz	12,100 kHz
22 Meter	13,570 kHz	13,870 kHz
19 Meter	15,100 kHz	15,800 kHz
16 Meter	17,480 kHz	17,900 kHz
13 Meter	21,450 kHz	21,850 kHz
11 Meter	25,600 kHz	26,100 kHz

20. POWER

Pressing this key toggles the unit on and off.

21. Display

This is a dot matrix LCD display. See the DISPLAY description for details.

22. Speaker

This is the opening for the internal speaker for the E1 receiver.

23. Telescopic Antenna

This is a 39 1/4" (1.003 meters) telescopic antenna for use on all bands.

TOP PANEL DESCRIPTION

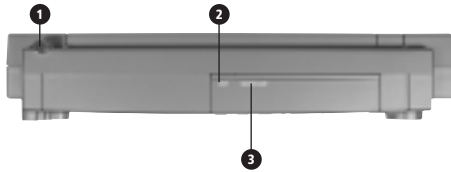

1. TELESCOPIC ANTENNA

This is a 39 1/4" (1.003 meters) telescopic antenna for use on all bands.

2. LIGHT

Pressing this key while the receiver is turned ON cycles the display illumination through four brightness states; Off, Dim, Medium and Bright. When the receiver is in the OFF state and connected to external power, the display, when lit, will be DIM. Pressing the 'LIGHT' button will cycle the display illumination on and off with no time out. If the unit is operating from batteries, the display will be lit only briefly when the unit is turned OFF. If, when OFF, the 'LIGHT' button is pressed once, the display will illuminate for 10 seconds and then go out. In the ON state, the display will be lit only briefly following control inputs. However, holding down the LIGHT key for 3 seconds will override the time out and allow the light to remain on continuously when the receiver is ON. The user must keep in mind, however that keeping the light on continuously when operating on batteries will considerably reduce battery life. More details concerning display illumination can be found on page 57 under "DISPLAY LIGHTING".

3. SNOOZE / SLEEP

When the receiver is ON, or turned on by the timer, pressing this bar will activate the SNOOZE mode, causing the receiver to turn OFF for 5, 10, 20, or 30 minutes, depending upon the setting of item 5 of the "CLOCK MODES"

menu. After the selected number of minutes have passed, the receiver will turn back on. To cancel a SNOOZE period early, cycle power OFF/ON with the 'POWER' key. When SNOOZE mode is active, "SNOOZE" will appear on the display.

When the receiver is OFF, other than in SNOOZE, pushing this bar will activate the SLEEP timer. This will turn the receiver ON for the default set time of 15 minutes, after which it will turn back OFF. To change the set time length from the default 15 minutes to 1 through 99 minutes, turn the receiver OFF and rotate the 'TUNING' control after pressing the SNOOZE / SLEEP bar. After setting the desired SLEEP time, press the bar again to activate SLEEP mode, or automatic entry will occur in 15 seconds. The displayed time is always in minutes. When SLEEP mode is active, a flashing "s XX" will appear in the lower left hand corner of the display, where "XX" is a number indicating the minutes of SLEEP time remaining.

E1 DISPLAY DESCRIPTION

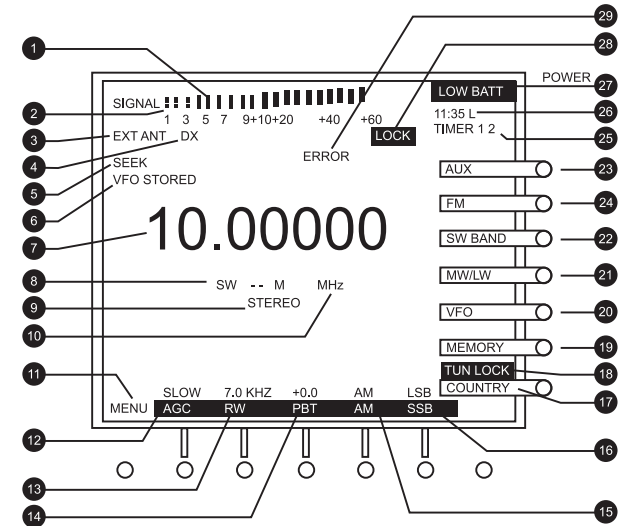

The following section describes the main display which will be seen when operating in the VFO mode. This is the display which the user will see most of the time. There are several other screens which may appear on this display under various conditions. These additional conditions will be covered later.

1. SIGNAL

The signal meter indicates the signal strength of the incoming signal. The stronger the signal, the more vertical bars appear from left to right across the display. From 100 through 30,000 kHz, the signal meter is calibrated in 5 units from 1 thru 9 and in decibels (dB) above 9 up to +60 dB. On the FM band, the signal strength is just relative.

2. SQUELCH LEVEL INDICATOR

This bar advances as the 'SQUELCH' knob is turned clockwise. It indicates the level at which the incoming signal is strong enough to overcome the SQUELCH setting. If the SQUELCH muting is enabled (which is done by menu) a signal level that is higher than the SQUELCH setting will be audible, while one that is below the SQUELCH setting will not. A signal stronger than the SQUELCH setting will cause scanning to stop on that frequency if the "CARRIER" stop mode is selected in the "RADIO SETTINGS" menu (item 2).

3. INTERNAL/EXTERNAL ANTENNA INDICATOR

EXT ANT or INT ANT will be displayed depending upon whether or not the mode in use (FM or HF) has its respective antenna switch on the side panel in the internal or external position.

4. DX

This indicator appears when the DX key is pressed, indicating that an RF preamplifier has been enabled to improve performance on weak signals. The DX setting will slightly reduce battery life when operating on battery power.

5. SEEK

This indicator is visible when the SEEK mode is enabled by pressing the SEEK key.

6. VFO STORED

This indicator appears when the 'TUNE' softkey is pressed. The 'TUNE' softkey is active in the COUNTRY and MEMORY modes.

7. FREQUENCY DISPLAY

This is the main frequency readout of the receiver.

8. SW -- M

Indicates the meter band to which the receiver is tuned when in SW mode. See the "Shortwave Band Designators" table on page 22 for a listing of meter bands. LW, MW or FM also appear here when those bands are selected.

9. STEREO

STEREO or MONO appear here when on the FM band. STEREO will appear if stereo is enabled from the "AUDIO SETTINGS" menu, and a stereo signal is being received.

E1 DISPLAY DESCRIPTION continued

10. MHz / kHz

Indicates whether the frequency displayed is shown in megahertz or kilohertz.

11. MENU

Labels the 'MENU' softkey which is used to bring up a series of menus. Repeatedly pressing this key will advance through additional menu pages.

12. AGC

Labels the 'AGC' (Automatic Gain Control) softkey and shows its release time status (Slow, Fast, or Auto). Auto mode selects SLOW release time but automatically switches to fast release only while tuning.

13. BW

Labels the Bandwidth softkey and shows its status (2.3, 4.0, or 7.0 kHz).

14. PBT

Labels the 'PBT' softkey. The 'PBT' softkey enables and disables the 'PBT' (Passband Tuning) knob. When the softkey is enabled, its frequency displacement relative to nominal is shown above "PBT". The reading will be between +2.0 and - 2.0 kHz.

15. AM

Labels the 'AM' softkey, and shows its status. The 'AM' softkey enables AM mode. When AM is enabled, "AM" appears over the "AM" softkey label. If the softkey is pressed a second time, "AM SYNC" appears over the "AM" label to indicate that the synchronous detector is operating.

16. SSB

This labels the 'SSB' softkey and shows its status. Pressing the 'SSB' softkey enables single sideband reception, causing either "USB" or "LSB" to appear above the "SSB" label. Pressing the 'SSB' softkey again after SSB is selected will toggle the display between "USB" and "LSB". When AM SYNC has been selected, pressing the 'SSB' softkey will toggle through the modes of the AM synchronous detector: USB, LSB and DSB.

17. COUNTRY

This labels the 'COUNTRY' softkey. When this softkey is pressed, Country mode is selected and the label appears as "COUNTRY".

18. TUN LOCK

This indicator appears when the 'FAST / TUNING LOCK' softkey has been pressed for 2 seconds. It indicates

that the 'TUNING' knob has been locked out and will have no affect.

19. MEMORY

This labels the 'MEMORY' softkey. When this softkey is pressed, MEMORY mode is selected and the label appears as "MEMORY".

20. VFO

This labels the 'VFO' softkey. When this softkey is pressed, the receiver returns to the VFO mode from COUNTRY or MEMORY modes, but the frequency being received from the MEMORY or COUNTRY modes is not transferred. The frequency displayed will be the same as was last being received when last in VFO mode. The indicator will appear as "VFO" when VFO mode is active.

21. MW / LW

This indicator labels the 'MW / LW' select softkey. Pressing this softkey will select either MW (AM Broadcast) or LW (Long Wave) frequency ranges. Repeatedly pressing this softkey will toggle between these two modes. Depending upon the mode selected, this indicator will appear either as "MW / LW" or "MW / LW".

22. SW BAND

This indicator labels the 'SW BAND' softkey. Pressing this softkey once selects the SW (Short Wave) band (1.8 - 30.0 MHz). This gives an indication of "SW BAND" on the display. Pressing this softkey a second time causes the display to appear as "SW BAND", and permits the tuning knob or the '< SELECT >' key to scroll through the available meter bands as shown on the "Shortwave Band Designator" table on page 16. If no movement of the 'TUNING' knob or input to the '< SELECT >' key occurs for 3 seconds, the display will revert back to "SW BAND" and normal tuning will resume.

23. AUX

This labels the 'AUX' softkey. Pressing this softkey activates the AUX mode and causes the indicator to appear as "AUX". Selecting this mode enables audio fed in the LINE IN jack on the side panel to be fed through to the E1 receiver's audio system.

24. FM

Pressing this softkey once selects the FM Broadcast band (76 - 90 MHz or 87 - 108 MHz) and causes the indicator to appear as "FM / AUX".

E1 DISPLAY DESCRIPTION continued

25. TIMER 1 2

This display appears when one or both of the event timers are enabled.

26. TIME DISPLAY

This displays the time, which can be either Greenwich Mean Time (GMT) or Local time (L). If the time display is flashing, this is an indication that the time has not been set. See "Clock and Timer Functions" on page 52.

27a. LOW BATT

This flashing reverse video indicator appears when no external AC Adapter is connected, and the battery voltage is too low for satisfactory operation. If this flashing indicator is seen, the batteries should be replaced.

27b. POWER LOSS

This indicator, which appears in the same location on the display as "LOW BATT", will be seen when the power is lost. It means that the receiver is operating

from the internal batteries, if so equipped. If the POWER LOSS BEEP is enabled (AUDIO SETTINGS menu, selection 3), there will also be four beeps in rapid succession, once per minute. (Volume controlled).

28. LOCK

This indicator appears when the 'CLEAR/LOCK' key has been pressed for 3 seconds. When this condition exists, all front panel keys (except for 'CLEAR/LOCK') plus the 'TUNING' and 'PBT' knobs will be ineffective. Pressing 'CLEAR/LOCK' again for 3 seconds will enable normal operation, and the "LOCK" indicator will disappear.

29. ERROR

This indicator will appear along with an audio beep when an error condition exists, such as pressing one of the softkeys which has no label in the mode selected.

SIDE PANEL DESCRIPTION



1. TELESCOPIC ANTENNA

The receiver has a built-in telescopic antenna that can be used on all bands. Note that the pivot point section of the antenna must be exposed out of its nesting tube to permit moving the antenna from its vertical orientation. Extend the telescopic sections and position the antenna for best signal reception. Be sure the corresponding side panel antenna select switches are set to the 'INTERNAL' position for TELESCOPIC antenna reception.

2. LINE IN

This 1/8" diameter stereo jack is used to feed in audio from an external source such as a CD or cassette tape player. The input level should be approximately 300 mV, at an impedance of 47K ohm. This input is enabled when the AUX mode is selected. When in this mode, the VOLUME, BASS and TREBLE controls are effective.

3. LINE OUT

This 1/8" diameter stereo jack provides a constant low level audio source that is independent of the front panel 'VOLUME', 'TREBLE' and 'BASS' control settings. It is designed to interface to a tape recorder, CW / RTTY demodulators, stereo amplifiers, etc.

SIDE PANEL DESCRIPTION continued

4. ANTENNA HF

This switch selects between the internal TELESCOPIC antenna and the external antenna connector when receiving LW, MW, or SW frequency ranges.

5. ANTENNA FM

This switch selects between the internal TELESCOPIC antenna and the external antenna connector when receiving the FM Broadcast band (76 - 90 MHz or 87 - 108 MHz).

6. EXT ANTENNA

This PAL type male input connector is designed for an unbalanced 50 to 75 ohm input connection that is encountered with coaxial feeds.

7. DC IN 9 V

Connect the AC ADAPTER wall transformer output cable to this connector. The receiver requires 9 VDC power at approximately 1 Amp current. With external DC power applied, the internal batteries are not used.

8. EXT SPEAKER

This 1/8" monophonic connector provides 1.25 to 3.0 watts audio output for an external 4 to 8 ohm speaker.

9. HEADPHONE

This connector accepts a 1/8" (3.175 mm) stereo/mono headphone connector. Stereo reception is possible only in the FM mode. All speaker outputs are automatically switched off when

GETTING STARTED

GENERAL OPERATING INFORMATION

The *etón* E1 receiver has been designed for ease of use. Please take a few moments to read through this section and familiarize yourself with general operating information. In this manual, the term AM stands for Amplitude Modulation, not the commercial AM broadcast band of 530 - 1710 kilohertz. When referring to the commercial AM broadcast band, the term MW (medium wave) is used.

FIRST STEPS

Please refer to the front panel illustration on page 13 and set the controls as described below.

- Install 4 "D" batteries or connect AC ADAPTER.
- Fully extend the telescopic antenna and adjust to a vertical position, or connect an external antenna to the side panel EXT. ANTENNA jack. Set side panel 'ANTENNA HF' and/or 'ANTENNA FM' switch(es) to appropriate position(s) (INTERNAL or EXTERNAL).
- Press 'POWER' and adjust 'VOLUME' to a comfortable level.
- Select the desired band by pressing the 'FM', 'SW' or 'MW/LW' softkeys until the desired band is displayed on the front panel display. The selected band will be indicated by reverse video on the display. For example: "MW / LW".
- Enter the desired frequency by using one of several methods as described in "DIRECT FREQUENCY ENTRY" or use the 'TUNING' knob to tune until the desired frequency is displayed.

DIRECT FREQUENCY ENTRY

Direct entry of a desired frequency is possible using the 'Direct-Key-Input' keys. While entering a frequency, if an incorrect frequency is entered, pressing the 'CLEAR/LOCK' key will clear the entry in progress and return the receiver to its previous settings. The second depression of the decimal (.) key acts as an 'ENTER' and causes immediate response to the entered frequency. If you do not press the decimal (.) key a second time at the end, the receiver will automatically enter the frequency after a slight delay. Enter frequency as follows:

(A) The LW and MW (AM broadcast) bands enter and display in kHz (Kilohertz). A maximum of 6 digits may be entered.

Examples:
700 KHz
Press '7', '0', '0', '.', '.', '.' **
1290.00 kHz
Press '1', '2', '9', '0', '.', '.', '0', '0' *

* When the maximum number of allowed digits is entered, the decimal point will be automatically placed between the 1 kHz and .1 kHz digits and need not be entered.

** The second depression of the '.' key acts as an 'ENTER' and causes immediate response to the entered frequency. If you do not press the decimal '.' a second time at the end, the receiver will automatically enter the frequency after a slight delay.

GETTING STARTED continued

(B) The SW band (1.8 - 30.0 MHz) frequencies are displayed and entered in kHz or MHz, depending upon the user's selection from item 5 of the RADIO SETTINGS menu. A maximum of 7 digits may be entered. To make the menu selection, press the 'MENU' softkey once. Then press 'Direct-Key-Input' key '5'. Repeatedly pressing the '5' key toggles between kHz and MHz as the display and entry method for the SW band. Leave the reverse video entry 0 on the desired display method. For example, line 5 on the menu should appear as follows for entry in kHz:

" 5 SW BAND ENTRY kHz / MHz".

After making this selection, press 'Direct-Key-Input' key '9' to exit the menu. Note that if kHz is selected from the menu, the display will show frequencies from 1.8 - 30.0 MHz in Kilohertz, and entries should be made in kHz.

Example:

14,258.1 kHz
Press '1', '4', '2', '5', '8', '.', '1', '.', '.' **
OR Press '1', '4', '2', '5', '8', '.', '1', '0' *
If MHz was selected from the menu all frequency entries should be made in MHz.

Example:

14.2581 MHz
Press '1', '4', '.', '2', '5', '8', '1', '.', '.' **
OR Press '1', '4', '.', '2', '5', '8', '1', '0' *

* When the maximum number of allowed digits is entered, the 7th digit acts as an enter key, and a second '.' need not be entered
** The second depression of the '.' key acts as an 'ENTER' and causes immediate response to the entered frequency. If you do not press the decimal '.' a second time at the end, the receiver will automatically

enter the frequency after a slight delay.
(C) FM broadcast band enters and displays in MHz (megahertz) regardless of the RADIO SETTINGS menu setting. A maximum of 5 digits may be entered for FM.

Examples:

97.7 MHz
Press '9', '7', '.', '.', '7', '.', '.' **
107.7 MHz
Press '1', '0', '7', '.', '.', '7', '.', '.' **
OR Press '1', '0', '7', '.', '.', '7', '0' *

Attempting to enter a frequency outside the tuning range of the *etón* E1 receiver will cause the ERROR annunciator to flash and an error beep to be heard. The receiver will then return to its previous settings.

SHORTWAVE 'METER' BAND DESIGNATOR ENTRY

To facilitate tuning to particular sections of the shortwave band that contain many worldwide broadcasts of news, information and music, the *etón* E1 receiver permits entry of the 'METER' band designator. In some cases, the worldwide broadcast station may not announce its exact operating frequency, but will announce the 'METER' band in which it is operating or to which band it will move to improve worldwide reception at a particular time of day. By entering this 'METER' band number, the receiver automatically tunes to the low frequency end of the corresponding 'METER' band. The search for the new station location is thus limited to a particular smaller section of the entire shortwave band spectrum. The Shortwave Band Designators and corresponding frequency ranges are as follows:

Shortwave Band Designators

Band	Low	High Freq
120 Meter	2300 kHz	2500 kHz
90 Meter	3200 kHz	3400 kHz
75 Meter	3900 kHz	4000 kHz
60 Meter	4750 kHz	5060 kHz
49 Meter	5800 kHz	6200 kHz
41 Meter	7100 kHz	7600 kHz
31 Meter	9500 kHz	9900 kHz
25 Meter	11,600 kHz	12,100 kHz
22 Meter	13,570 kHz	13,870 kHz
19 Meter	15,100 kHz	15,800 kHz
16 Meter	17,480 kHz	17,900 kHz
13 Meter	21,450 kHz	21,850 kHz
11 Meter	25,600 kHz	26,100 kHz

GETTING STARTED continued

Press the 'SW BAND' softkey to enter the shortwave band tuning mode. The SW portion of the display indicator will now be in reverse video. Now press the 'SW BAND' softkey a second time.

The display indicator will now appear as "SW BAND", and the 'METER' number entry prompt on the display will be flashing. (See #8 on the LCD Display Description on page 18). At this point, you have approximately 3 seconds to do one of the following:

- (1) You can enter a shortwave band 'METER' number with the 'Direct-Key-Input' keys. For example, key in '4', '1' for the 41 meter band.
- (2) You can scroll through the available meter bands using the 'TUNING' knob or the '< SELECT >' key, stopping on the desired 'METER' band. If you stop on a "METER" band for more than 3 seconds, the

receiver will tune to that band, the "SW BAND" indicator will appear as "BAND", and the shortwave band SW "METER" prompt will quit flashing.

To enter a shortwave band 'METER' designator, press the 'SW BAND' softkey to display a flashing 'METER' number entry prompt. The prompt will flash for approximately 3 seconds after the 'SW BAND' softkey is pressed. While it is still flashing, enter one of the listed two or three digit Band numbers corresponding to the desired 'METER' band designator using the 'Direct-Key-Input' keys. While the 'METER' annunciator is flashing, the '< SELECT >' keys can also be used to step quickly from band to band. After selection of the 'METER' band, use the 'TUNING' knob or '< SELECT >' keys to change the frequency, or press the 'Direct-Key-Input' keys to make a direct frequency entry.

FREQUENCY RESOLUTION

The E1 receive tunes in the following steps:

Mode	Display *Resolution	Tuning *Resolution	< SELECT >
MW AM:	10 Hz 100 Hz 1 kHz	10 Hz 100 Hz 1 kHz	10 kHz / 9 kHz
MW SSB:	10 Hz 1 kHz	10 Hz 1 kHz	10 kHz / 9 kHz
LW & SW AM	10 Hz 100 Hz 1 kHz	10 Hz 100 Hz 1 kHz	5 kHz
LW & SW SSB	10 Hz 1 kHz	10 Hz 1 kHz	5 kHz
FM	10 kHz 100 kHz	20 kHz 100 kHz	100 kHz

* Selectable using 'FAST' button.

FRONT PANEL LOCK (UNLOCK)

All front panel keys (with the exception of the 'CLEAR / LOCK' key), as well as the 'TUNING' knob can be locked if desired. First, be sure the E1 receiver is not in T.SCAN or SEEK mode. Press and hold the 'CLEAR/LOCK' key which is one of the 'Direct-Key-Input' keys. The "LOCK" and "TUN LOCK" annunciators will appear indicating the front panel controls are locked out. "VOLUME", "BASS", "TREBLE", and "SQUELCH" are still functional. Press and hold the 'CLR/LOCK' key to unlock. The "LOCK" and "TUN LOCK" annunciators will disappear, indicating the front panel controls are once again active. The 'CLEAR /

LOCK' key may be used even when the radio is off to lock the 'POWER' key to prevent accidental power activation.

AM SYNCHRONOUS OPERATION

For general tuning and listening, normal AM is best. If, however, the received signal sounds distorted, or interference from adjacent stations is present, AM synchronous should be engaged. The synchronous detector in your receiver can greatly reduce the severe audio distortion that can occur due to signal fading. The detector also permits selectable tuning to either the upper or lower sideband portion of an AM signal. Since most

GETTING STARTED continued

all AM (LW, MW and SW) broadcasting generally uses double-sideband transmission, detection of either of the two sidebands results in full reception of the transmitted information. The selectable sideband tuning and detection not only aids reception by permitting tuning to the stronger or less distorted sideband, but also permits rejection of the sideband nearer to the interfering signal(s).

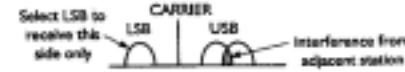

The synchronous detector will lock to the strongest signal that is within the IF passband when it is activated. Most of the time, the strongest signal will be the carrier of the desired signal. First, be sure the main tuning is set to within 1 kHz of the desired station's transmitting frequency. Press the 'AM' softkey after AM is already selected to activate synchronous operation. 'AM SYNC' will briefly flash on and off above the 'AM' softkey and will then stop flashing as the AM SYNC detector locks on to the carrier frequency.

If adjacent channel interference or any other undesired signal is sufficiently strong, the synchronous detector may lock to it instead. In that case, press the 'AM' softkey again to turn the synchronous detector off, and repeat the tuning process. For severe cases of fading, set the bandwidth to 4 kHz by pressing the 'BW' softkey until 4.0 kHz appears above the 'BW' softkey. If interference is present, repeatedly press the 'SSB' softkey to select whichever of USB, DSB or LSB produces the least interference once 'AM SYNC' has been selected. If the interference is sufficiently severe to prevent reception, select a narrower IF bandwidth and retune to the desired signal. After reception is obtained, select a wider bandwidth and/or alternate sideband if desired. When 'AM SYNC' has been activated, moving the 'TUNING' knob will cause the SYNC circuit to momentarily disengage (indicated by "AM SYNC" flashing), then back on again when tuning has stopped. The PBT control can sometimes help in reducing adjacent interference. For more details see "PASS-BAND TUNING" in the next column.

AM SYNC will not operate properly on intermittent transmissions such as those encountered on CB radio band. For those types of transmissions, use the AM mode. Press the 'AM' softkey to turn the synchronous detector off before selecting LSB or USB modes for SSB operation.

SSB OPERATION

Tuning in a single sideband (SSB) signal can be somewhat frustrating for the first time listener. In either of the E1 receiver's SSB modes, LSB (lower sideband), or USB (upper sideband), the receiver will select the 2.3 kHz bandwidth automatically. Generally LSB is used below 10 MHz and USB is used above 10 MHz. When initially tuning in the desired station, tune slowly. If the station is unintelligible, try the other sideband, again tuning slowly. A station tuned in on the wrong sideband is totally unreadable but a station mistuned on the correct sideband may sound like 'Donald Duck'. Further tuning will result in a more normal voice pitch. Always start with the 'PBT' off when initially tuning SSB signals.

PASSBAND TUNING

The passband tuning (PBT) feature allows for moving the IF passband of the receiver relative to the detector BFO (beat frequency oscillator) when operating in SSB mode. This can be quite useful in receiving a weak signal in the presence of nearby interference. Passband tuning is available on the LW, MW, and SW bands, and is engaged or disengaged by pressing the 'PBT' softkey.

PBT status is shown on the display directly above the softkey.

When it is engaged, the displacement in kilohertz from the BFO frequency is shown directly above the softkey label, and the degree of IF passband displacement is controlled by the PBT knob. When PBT is disengaged, there will be no information displayed above the 'PBT' softkey label, and the PBT knob will have no effect. To use PBT, tune in the desired SSB signal for best audio quality as you normally would with PBT off. You will find that PBT is most effective when the 2.3 kHz IF bandwidth is used. Then press the 'PBT' softkey and adjust the PBT knob for the best compromise between minimum adjacent signal interference and acceptable audio quality of the desired signal.

Enhanced SSB, when engaged (RADIO SETTINGS Menu, item 1), provides 30 dB of additional rejection of the undesired sideband through the use of audio phasing circuitry. Using this in combination with Passband Tuning can effectively narrow the IF to less than the 2.3 kHz IF filter.

PBT also functions in AM and AM SYNC modes, but in these modes it acts primarily as a frequency offset, which can also be accomplished with the 'TUNING' knob. When operating in AM SYNC mode, tuning the

GETTING STARTED *continued*

PBT knob will cause 'AM SYNC' to flash on and off temporarily until the system once again locks on to the desired carrier.

FM OPERATION

FM reception is perhaps the easiest mode to use on the *etón* E1 receiver. The AGC and BANDWIDTH settings are not used in FM. In fact, all of the function softkeys along the bottom edge of the display except the 'MENU' softkey have no function on FM and the labels on the display for these softkeys disappear. Attempting to use one of these softkeys will result in an 'ERROR' beep. All FM stations in the U.S. end in an odd 100 kHz, i.e. 97.7 MHz, and are spaced 200 kHz apart. The *etón* E1 receiver has the ability to tune in 20 kHz steps to allow tuning in between stations that could be covered up by stronger adjacent stations. Additionally, when headphones are used, or if the LINE OUT jack is fed into an external stereo sound system, true stereo reception is possible. The 'STEREO' indicator on the display will appear when a stereo station is tuned in. 'MONO' will appear in this location if the transmitting station is not in stereo, if no signal is being received, or if MONO is selected from the AUDIO SETTINGS menu. To select between STEREO and MONO from the AUDIO SETTINGS menu, proceed as follows:

- Press the 'MENU' softkey.
- Press the 'Direct-Key-Input' '2' key or press 'MENU' two more times. This will access the AUDIO SETTINGS menu.
- Press the 'Direct-Key-Input' '1' key to cycle between MONO and STEREO.

When STEREO is enabled, the receiver will automatically switch to stereo and provide left and right audio from the HEADPHONE and LINE OUT jacks when a stereo FM signal is being received. If the headphones are removed while listening to a stereo broadcast the receiver will provide monaural audio from the internal or an external speaker.

AGC OPERATION

The *etón* E1 receiver provides the ability to select a SLOW, FAST, or AUTO AGC setting. Each of the three settings will permit automatic control of the receiver's gain thereby producing a constant audio output free of distortion. Generally, the SLOW AGC setting is preferred for reception of AM and SSB signals. The FAST AGC setting allows more rapid automatic receiver gain adjustment to quickly fading signal levels. The AUTO setting provides FAST AGC while tuning between sta-

tions to prevent the user from missing weak stations between strong ones. However, once a station is tuned in, it automatically switches to SLOW for smoother audio output. The AGC does not function in the FM mode.

MICROPROCESSOR RESET

A power-up reset routine will be activated anytime after the receiver COMPLETELY loses power, from internal batteries and external DC input. However, short term power failures of up to 10 minutes are masked by an internal back-up capacitor. This will allow ample time for battery replacement without loss of the internal clock. Note: Any programmed memory channels and timer settings will NOT be lost under a power-up reset due to the memory design of the *etón* E1 receiver.

BEEP TONES

The *etón* E1 receiver responds to nearly all key depressions with an audible beep unless the beep has been disabled by means of menu entry 2 in AUDIO SETTINGS menu. This menu is accessed by pressing the 'MENU' softkey three times, or by pressing the 'MENU' softkey once to access the MAIN MENU, and then pressing the 'Direct-Key-Input' '2' key. No beep is generated under any condition for depressions of the "< SELECT >" keys when in VFO mode. Beep tones indicate the following:

- One short tone for a key depression.
- One short, high tone when storing a MEMORY or COUNTRY channel.
- One long, low tone for any illegal key depression.
- Four quick beeps at one minute intervals if batteries are installed, an external power source is connected, and the external power is lost.

This feature must be enabled from AUDIO SETTINGS menu item 3. Note that the volume of the beep tones is controlled by the 'VOLUME' control, so if the 'VOLUME' control is turned all the way down, no beep tones will be heard.

MEMORY FUNCTIONS

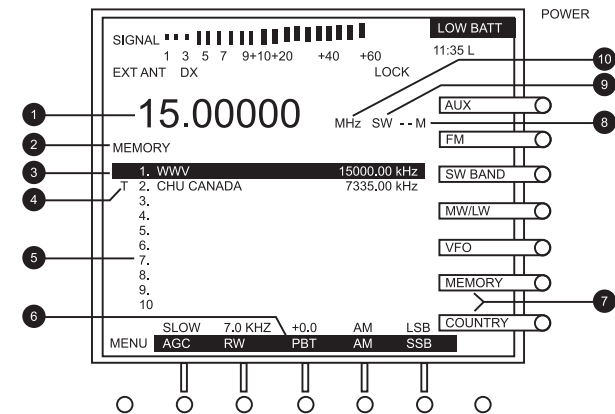

MEMORY DESCRIPTION

The E1 receiver contains 1700 memory channels that can be used to store and recall commonly monitored frequencies. The first 500 of these are referred to simply as MEMORY channels. The remaining 1200 are referred to as COUNTRY channels. More on COUNTRY in the next section. The 500 MEMORY channels are displayed in groups of 10 per screen and each saved frequency can be stored with an identifying name. They can be scanned using the SEEK function which can stop on any stored channel that has a predetermined signal level, or the MEMORY channels can be scanned selectively using the T.SCAN function. With MEMORY channels programmed, you can use the T.SCAN function to selectively monitor desired MEMORY frequencies. The following operating parameters may be stored in any MEMORY channel: (1) Frequency, (2) Mode, (3) Bandwidth, (4) AGC setting, (5) PBT setting, (6) Synchronous Detector setting.

THE MEMORY DISPLAY

Please refer to the numbered figure above.

1. Channel Frequency

This is the frequency that is stored in the selected MEMORY channel.

2. MEMORY

This indicator identifies the screen as a MEMORY display as opposed to a COUNTRY display.

3. Cursor

This reverse video segment identifies the selected MEMORY channel. This Cursor is moved up or down through the ten displayed channels one at a time using the 'TUNING' knob or a page at a time (10 channels)

using the '< SELECT >' key. If the 'FAST / TUNING LOCK' key is pressed, the 'TUNING' knob will scroll through the channels ten at a time.

4. T

This indicator marks this channel as being one selected for T.SCAN. T.SCAN searches through all MEMORY and COUNTRY channels marked with the 'T' and will ignore all others. T.SCAN will stop in any channel marked with a 'T' which has a signal strength greater than the SQUELCH setting. It will proceed to the next marked channel either based on a 5 second time interval, or will stay on the channel on which it stopped until the 'T.SCAN' key is pressed again. Which of these T.SCAN methods is used is determined by setting 2 in the RADIO SETTINGS menu. The "T" tag is added to or removed from the MEMORY channel on which the cursor rests by pressing the 'TAG' key.

5. Channel Numbers

These numbers identify the memory channels from 1 to 500, ten at a time. When the cursor reaches the end of a group of ten, the numbers displayed advance by ten. For example if the cursor were sitting on 10, and the right hand '< SELECT >' key was pressed, the cursor would jump to the top of the column with numbers 11 thru 20 displayed.

6. Function Key Labels

These labels, with their associated parameters, disappear if you scroll through a channel that is programmed on an FM band frequency.

7. MEMORY

The 'MEMORY' softkey label appears as "MEMORY" when the softkey is pressed, indicating that MEMORY

MEMORY FUNCTIONS continued

mode has been selected.

8. Meter Band Identifier

Identifies the meter band of the selected SW frequency. If the channel is an FM broadcast band frequency, "STEREO" or "MONO" appears in this location.

9. Band Identifier

Indicates whether the memory channel is in the LW, MW, SW, or FM bands.

10. MHz / kHz

Identifies whether the frequency is displayed in megahertz or kilohertz.

STORING A MEMORY CHANNEL

There are two ways to store a channel. The first is from VFO mode, and the other is from MEMORY mode.

To store a channel from VFO mode proceed as follows:

- First select the mode and frequency that you wish to store, as you normally would do in VFO mode. Make sure you have set all the function parameters to your preference.
- Then press the 'STORE' key, followed by the 'MEMORY' softkey. This will take you to the MEMORY screen similar to that shown above
- Use the 'TUNING' knob or the '< SELECT >' key to select the desired blank MEMORY number.
- Press the 'STORE' key again. The selected frequency will appear at the selected MEMORY channel in reverse video, and a flashing white cursor will appear in front of the selected channel number.
- Within 10 seconds, you must either begin to program a name for the desired channel, or press the 'STORE' key again to store the channel without a name or to use the previously stored name.
- To name the channel, while the white cursor is flashing, use the 'TUNING' knob to scroll through the alphanumeric characters until you find the one you want. Then press the right hand '< SELECT >' key to advance the cursor to the next position. Repeat this process until you have entered all the characters you need. Previously named channels can be revised in a similar manner.
- When you have finished entering the channel name, press the 'STORE' key again. You will hear a confirming beep and will be returned to the VFO mode.

To store a memory channel from MEMORY mode, first enter MEMORY mode by pressing the 'MEMORY' soft-

key. Then proceed as follows:

- Select an empty MEMORY channel number using the 'TUNING' knob, or the '< SELECT >' keys.
- Press the Mode softkey for the frequency range that contains the frequency you wish to store, for example, 'FM', 'MW / LW', or 'SW'. This will cause the 'MEMORY' softkey indicator to return to normal video, and the pressed Mode softkey indicator will appear in reverse video.
- Use the 'TUNING' knob to tune in the desired frequency, and use the Function softkeys (except for FM mode) to set the parameters as desired.
- Press the 'STORE' key. This will take you back to the MEMORY screen with the cursor on the previously selected MEMORY location. Then press the 'STORE' key again. You will see a white cursor flashing within the reverse video cursor.
- Within 5 seconds, you must either begin to program a name for the desired channel, or press the 'STORE' key again to store the channel without a name.
- To name the channel, while the white cursor is flashing, use the 'TUNING' knob to scroll through the alphanumeric characters until you find the one you want. Then press the right hand '< SELECT >' key to advance the cursor to the next position. Repeat this process until you have entered all the characters you need.
- When you have finished entering the channel name, press the 'STORE' key again. You will hear a confirming beep. The 'MEMORY' softkey indicator will return to reverse video, and you will be able to scroll through all MEMORY channels using the 'TUNING' knob and the '< SELECT >' keys.

RECALLING A MEMORY CHANNEL

To select a specific memory channel, press the 'MEMORY' softkey to enter memory mode. This will cause 'MEMORY' softkey label to appear in reverse video. Then use the 'TUNING' knob or the '< SELECT >' key to scroll through the MEMORY numbers. Note that pressing the 'FAST / TUNING LOCK' key will cause the 'TUNING' knob to advance through the channels ten at a time instead of one at a time. For this to occur, you must start moving the 'TUNING' knob within 3 seconds of pressing the 'FAST / TUNING LOCK' key. Pressing the 'FAST / TUNING LOCK' key will NOT, however cause the '< SELECT >' key tuning rate to change. It will continue to scroll through MEMORY channels ten channel numbers at a time.

If you know the number of the MEMORY channel you

MEMORY FUNCTIONS continued

want to receive, you can go to it directly by entering the number on the 'Direct- Key-Input' keypad. If less than a four digit number is entered, there may be a slight delay between the time you enter the number and the time the channel change actually takes place. However, if you enter a four digit number, the channel change will occur immediately upon entry of the fourth number.

Example:

To enter MEMORY channel 475, press '0', '4', '7', '5'. If you want to temporarily change a parameter of a received MEMORY channel, or simply want to "tune around" the stored frequency, there are two ways to do this.

The first is to simply press any of the Function softkeys below the display which are labeled in reverse video, or the 'FM', 'SW BAND', or 'MW/LW' softkeys as appropriate. This will cause the 'MEMORY' softkey to be displayed in normal video, the 'VFO' label will be

shown in reverse video, and will allow you to tune the frequency, change parameters, or change bands. To return to scrolling through MEMORY channels with the 'TUNING' knob, simply press the 'MEMORY' softkey again.

The other method is to press the 'TUNE' softkey. This will return the receiver to the VFO mode and will transfer the MEMORY channel frequency and all associated parameters to the VFO for further tuning.

DELETING A MEMORY CHANNEL

Select the MEMORY channel to be deleted as described in "RECALLING A MEMORY CHANNEL". Press and hold the 'DELETE' key for 3 seconds. A high pitched beep will be heard to indicate that the contents stored in the selected MEMORY channel number have been deleted, and you will see the name and frequency disappear from the selected MEMORY channel location.

COUNTRY FUNCTIONS

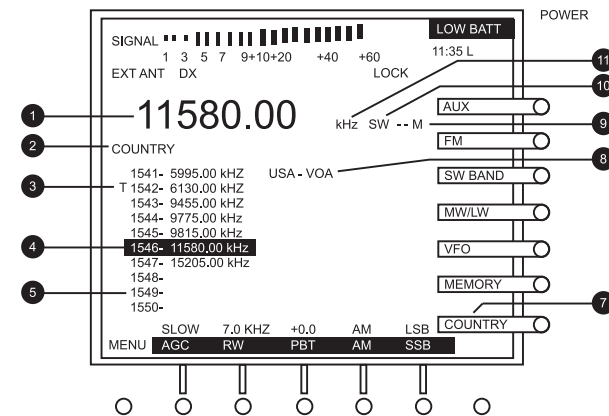

COUNTRY DESCRIPTION

The *etón* E1 receiver contains 1200 memory channels grouped in a category named "COUNTRY". These are in addition to the 500 MEMORY channels described in the previous section. These 1200 COUNTRY memory channels are divided among 111 countries from Afghanistan to Yugoslavia with 10 memory channels assigned per country and with 90 memory channels remaining with no country assigned. These COUNTRY memory channels are numbered from 501 to 1700.

They are displayed in groups of ten, and can be used to store and recall commonly monitored frequencies. Unlike the MEMORY channels described previously, COUNTRY channels cannot have names assigned to each channel.

While the intention here was to make it easier for the user to group interesting frequencies by country, any frequency can be stored in any COUNTRY channel.

COUNTRY FUNCTIONS continued

COUNTRY channels can be scanned using the SEEK function which can stop on any stored channel that has a predetermined signal level. With COUNTRY channels programmed with a "T" tag, you can use the T.SCAN function to selectively monitor desired COUNTRY frequencies. The following operating parameters may be stored in any COUNTRY channel: (1) Frequency, (2) Mode, (3) Bandwidth, (4) AGC setting, (5) PBT setting, (6) Synchronous Detector setting.

THE COUNTRY DISPLAY

Please refer to the numbered figure above.

- (1) Channel Frequency - This is the frequency that is stored in the selected COUNTRY channel.
- (2) COUNTRY - This indicator identifies the screen as a COUNTRY display as opposed to a MEMORY display.
- (3) T - This indicator marks this channel as being one selected for T.SCAN. T.SCAN searches through all COUNTRY channels marked with the "T" and will ignore all others. T.SCAN will stop on any channel marked with a "T" which has a signal strength greater than the SQUELCH setting. It will proceed to the next marked channel either based on a 5 second time interval, or will stay on the channel it stopped on until the 'T.SCAN' key is pressed again. Which of these T.SCAN methods is used is determined by the setting of item 2 in the RADIO SETTINGS menu. The "T" tag is added to or removed from the COUNTRY channel on which the cursor rests by pressing the 'TAG' key.
- (4) Cursor - This reverse video segment identifies the selected COUNTRY channel. This Cursor is moved up or down through the ten displayed channels one at a time using the 'TUNING' knob or a page at a time (10 channels) using the '<SELECT>' key. If the 'FAST / TUNING LOCK' key is pressed, the 'TUNING' knob and '<SELECT >' keys will scroll through the channels ten at a time. This is the way to scroll through all available countries in minimum time.
- (5) Channel Numbers - These numbers identify the COUNTRY channels from 500 to 1700, ten at a time. When the cursor reaches the end of a group of ten, the numbers displayed advance by ten. For example if the cursor was sitting on 600, and the right hand '<SELECT >' key was pressed, the cursor would jump to the top of the column with numbers 601 thru 610 displayed.
- (6) Function Key Labels - These labels, with their associated parameters, disappear if you scroll through a channel that is programmed on an FM band frequency.

- (7) COUNTRY - The 'COUNTRY' softkey label appears as "COUNTRY" when the softkey is pressed, indicating that mode has been selected.
- (8) Country Identifier - This label identifies the country to which the ten displayed channel numbers are assigned.
- (9) Meter Band Identifier - Identifies the meter band of the selected SW frequency. If the channel is an FM broadcast band frequency, "STEREO" or "MONO" appears in this location.
- (10) Band Identifier - Indicates whether the memory channel is in the LW, MW, SW, or FM bands.
- (11) MHz / kHz - Identifies whether the frequency is displayed in megahertz or kilohertz.

STORING A COUNTRY CHANNEL

There are two ways to store a channel. The first starts from VFO mode, and the other starts from COUNTRY mode. To store a channel from VFO mode proceed as follows:

- (A.) First press the 'VFO' softkey and select the mode and frequency that you wish to store, as you normally would do in VFO mode. Make sure you have set all the function parameters to your preference.
- (B.) Press the 'STORE' key and then press the 'COUNTRY' softkey. This will take you to the COUNTRY screen similar to that shown on the previous page.
- (C.) Use the 'TUNING' knob or the '<SELECT >' key to select the desired blank MEMORY number.
- (D.) Press the 'STORE' key again within 5 seconds. This will store the frequency and its associated parameters in the selected channel number. You will hear a confirming beep and will be returned to the VFO mode.

To store a memory channel from COUNTRY mode, first enter COUNTRY mode by pressing the 'COUNTRY' softkey. Then proceed as follows:

- (A.) Select an empty COUNTRY channel number using the 'TUNING' knob, or the '<SELECT >' keys.
- (B.) Press the 'TUNE' softkey. This will return you to the VFO mode. Select the mode for the frequency range that contains the frequency you wish to store. For example, 'FM', 'MW / LW', or 'SW BAND'.
- (C.) Use the 'TUNING' knob or the '<SELECT >' keys to tune in the desired frequency, and use the Function softkeys (except for FM mode) to set the parameters as desired.
- (D.) Press the 'STORE' key. This will take you back to COUNTRY mode with the cursor still on the channel number you selected previously. Press the

COUNTRY FUNCTIONS continued

'STORE' key again. You will hear a confirming beep and "COUNTRY STORED" will briefly appear on the display. The 'VFO' softkey indicator will return to reverse video indicating that normal VFO mode has been restored.

To store a memory channel from COUNTRY mode, first enter COUNTRY mode by pressing the 'COUNTRY' softkey. Then proceed as follows:

- (A.) Select an empty COUNTRY channel number using the 'TUNING' knob, or the '<SELECT >' keys.
- (B.) Press the 'TUNE' softkey. This will return you to the VFO mode. Select the mode for the frequency range that contains the frequency you wish to store. For example, 'FM', 'MW / LW', or 'SW BAND'.
- (C.) Use the 'TUNING' knob or the '<SELECT >' keys to tune in the desired frequency, and use the Function softkeys (except for FM mode) to set the parameters as desired.
- (D.) Press the 'STORE' key. This will take you back to COUNTRY mode with the cursor still on the channel number you selected previously. Press the 'STORE' key again. You will hear a confirming beep and "COUNTRY STORED" will briefly appear on the display. The 'VFO' softkey indicator will return to reverse video indicating that normal VFO mode has been restored.

RECALLING A COUNTRY CHANNEL

To select a specific COUNTRY channel, press the 'COUNTRY' softkey to enter COUNTRY mode. This will cause the 'COUNTRY' softkey label to appear in reverse video. Then use the 'TUNING' knob or the '<SELECT >' key to scroll through the COUNTRY numbers.

Note that pressing the 'FAST / TUNING LOCK' key will cause 'TUNING' knob to advance through the channels ten at a time instead of one at a time. For this to occur, you must start moving the 'TUNING' knob within 3 seconds of pressing the 'FAST / TUNING LOCK' key. Pressing the 'FAST / TUNING LOCK' key will NOT, however cause the '<SELECT >' key tuning rate to change. It will continue to scroll through COUNTRY channels ten channel numbers at a time.

If you know the number of the COUNTRY channel you want to receive, you can go to it directly by entering the number on the 'Direct- Key-Input' keypad. If less than a four digit number is entered, there may be a slight delay between the time you enter the number and the time the channel change actually takes place. However, if you enter a four digit number, the channel change will occur immediately upon entry of the fourth number.

Example: To enter COUNTRY channel 765, press '0', '7', '6', '5'.

If you want to temporarily change a parameter of a received COUNTRY channel, or simply want to "tune around" the stored frequency, there are two ways to do this.

The first method is simply press any of the Function softkeys below the display which are labeled in reverse video, or the 'FM', 'SW BAND', or 'MW/LW' softkeys as appropriate. This will return you to the VFO mode, will cause the 'COUNTRY' softkey to be displayed in normal video, and will allow you to tune the frequency, change parameters, or change bands. To return to scrolling through COUNTRY channels with the 'TUNING' knob, simply press the 'COUNTRY' softkey again. The other method is to press the 'TUNE' softkey. This will return the receiver to the VFO mode and will transfer the COUNTRY channel frequency and all associated parameters to the VFO for further tuning.

DELETING A COUNTRY CHANNEL

Select the COUNTRY channel to be deleted as described in "RECALLING A COUNTRY CHANNEL". Press and hold the 'DELETE' key for 3 seconds. A high pitched beep will be heard to indicate that the contents stored in the selected memory channel number have been deleted, and you will see the frequency disappear from the selected MEMORY channel number.

CHANGING OR ADDING COUNTRY NAMES

You can add to or modify the country names. To do so proceed as follows:

- Press the 'COUNTRY' softkey and use the 'TUNING' knob or '<SELECT >' keys to select the named ten channel block the name of which you wish to change or name. Note that each ten channel block begins with on 1 and ends on 10. For example, 501 - 510, 1691 - 1700. The reverse video cursor can be on any number within the selected block of ten.
- Press and hold the 'COUNTRY' softkey for 3 seconds. "EDIT NAME" will appear on the display, and a flashing cursor(" _ ") will appear.
- Within 3 seconds, use the 'TUNING' knob to select the first letter of the new name, and press the right '<SELECT >' key to advance the cursor to the position of the next letter or number to be added.
- Proceed in this manner until the full name of the country has been entered.
- When all of the desired alphanumeric characters have been added, press the 'STORE' key. You will hear a confirming beep, and "COUNTRY STORED" will appear briefly on the display.

E1 MENUS

In the following discussion concerning menus, the numbers presented in front of each item refer to the keys on the Direct-Key- Input keypad. To activate a menu item, simply press the numbered key corresponding to the menu number. On keys that toggle between two conditions, the selected condition will appear in reverse video.

MAIN MENU

The MAIN MENU is the first menu encountered when the 'MENU' softkey (left hand softkey below the display) is pressed. It appears as shown in the following illustration.

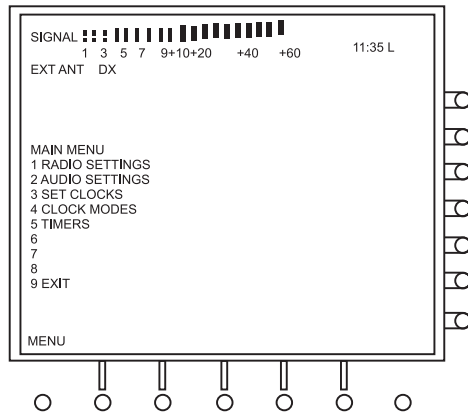

E1 MENUS continued

MAIN MENU

- 1. RADIO SETTINGS** - Pressing '1' takes you to the RADIO SETTINGS menu which allows setting parameters for enhanced SSB, scan stop mode, FM band frequency range, MW band tuning step size, and whether the SW band is displayed in kilohertz (kHz) or megahertz (MHz).
- 2. AUDIO SETTINGS** - Pressing '2' takes you to the AUDIO SETTINGS menu which allows setting audio related parameters including mono / stereo output, entry beep on/off, power loss beep on/off, and squelch muting on/off.
- 3. SET CLOCKS** - Pressing '3' takes you to the SET CLOCKS menu. From this menu, the local and GMT clocks can be set.
- 4. CLOCK MODES** - Pressing '4' takes you to the CLOCK MODES menu. This menu allows setting various clock related parameters including auto clock set on/off, automatic daylight savings time compensation on/off, local time offset from GMT time, snooze time, and whether or not timers override the lock function.
- 5. TIMERS** - Pressing '5' takes you to the TIMERS menu. From this menu the start times, stop times, and memory channels for both event timers can be set.
- 6. Unused**
- 7. Unused**
- 8. Unused**
- 9. EXIT** - Pressing '9' takes you back to the display you were viewing when MENU was pressed. This would be either the VFO, MEMORY or COUNTRY.

RADIO SETTINGS

The radio settings menu is reached either by pressing the MENU softkey twice, or by pressing '1' when the MAIN MENU is displayed. It appears as shown below.

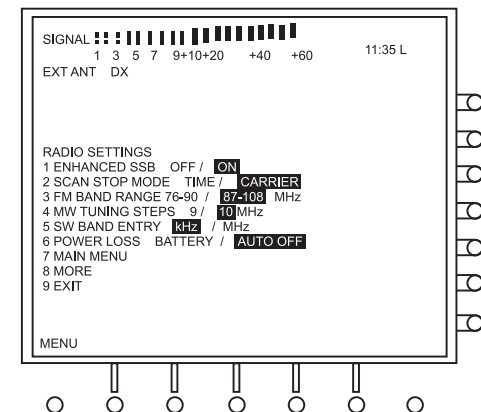

E1 MENUS continued

1. ENHANCED SSB OFF / ON - Pressing '1' toggles ENHANCED SSB ON and OFF. Enhanced SSB provides 30 Db of additional rejection of the undesired sideband through audio phasing circuitry, as shown in the following diagram.

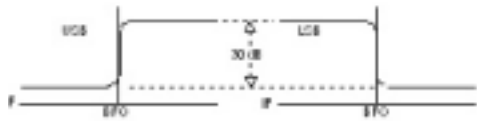

Using this in combination with passband tuning can narrow the IF to less than the normal IF filter bandwidth, and can provide considerable additional help in receiving weak signals in the presence of strong adjacent signals.

2. SCAN STOP MODE TIME / CARRIER - The '2' key toggles between TIME and CARRIER. When "TIME" is selected, a T.SCAN will stop on each MEMORY or COUNTRY channel that is marked with a "T" for 5 seconds, and will then move on to the next marked channel. If CARRIER is selected, a T.SCAN will stop on a carrier that exceeds the SQUELCH setting and will remain there as long as the carrier strength remains at that level. If the carrier goes away, or if its strength drops below the squelch setting, the T.SCAN will move on to the next marked channel.

3. FM 76 - 90 MHz / 87 MHz - 108 MHz - Pressing '3' toggles the frequency coverage on FM mode between 76 - 90 MHz and 87 - 108 MHz.

4. MW TUNING STEPS 9 / 10 kHz - When listening on the MW (AM broadcast) band, pressing the '<' or '>' ends of the '<SELECT >' key will tune through the band in either 9 or 10 kHz steps, depending on this setting. In the USA, broadcast stations are spaced at 10 kHz intervals. However in some other parts of the world, they are spaced at 9 kHz intervals. Therefore, if you are in the USA, select 10 kHz, but if you are in Europe, select 9 kHz. Use the '4' key to toggle between 9 and 10 kHz.

5. SW BAND ENTRY kHz / MHz - Use the '5' key to toggle between kHz and MHz. This determines whether frequencies on the SW band (1800 - 30,000 kHz) are displayed in kilohertz or megahertz.

6. POWER LOSS - Use the '6' key to toggle between BATTERY and AUTO OFF. When the AC Adapter is plugged in and powering unit, and AC power is lost, BATTERY keeps the unit running on battery power. AUTO OFF switches the unit off after 10 seconds to extend battery life.

7. MAIN MENU - Pressing the '7' key returns the user to the main menu.

8. MORE - Pressing '8' scrolls forward through the available menus. For example, the first press takes you to AUDIO SETTINGS, then SET CLOCKS, then CLOCK MODES, then TIMERS and then back to the MAIN MENU.

9. EXIT - Pressing '9' takes you back to the display you were viewing when MENU was pressed. This would be either the VFO, MEMORY or COUNTRY display.

E1 MENUS continued

AUDIO SETTINGS

The AUDIO SETTINGS menu is reached either by pressing the MENU softkey three times, or pressing the MENU softkey once and then pressing the '2' key. It appears as shown in the following illustration.

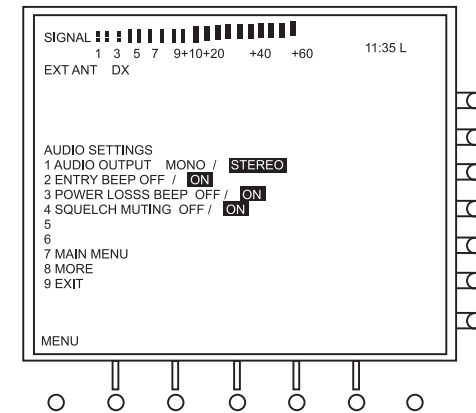

1. AUDIO OUTPUT MONO / STEREO - Pressing '1' selects between MONO and STEREO when receiving on the FM broadcast band. When STEREO is selected, "STEREO" will appear on the VFO, MEMORY, and COUNTRY displays when an FM stereo signal is being received, and stereo audio will be available from the 'Headphone', and 'Line Out' jacks. When MONO is selected, "MONO" will appear on the above mentioned displays when receiving any FM broadcast signal regardless of whether or not it is transmitting in stereo, and only mono audio output will be available. It is occasionally advantageous to switch to MONO mode when receiving a weak stereo station because it will reduce the background noise.

2. ENTRY BEEP - Use the '2' key to toggle between beep ON and beep OFF. When beep is ON, beep tones will be heard when keys are pressed, error conditions exist, or various pieces of information are stored. If beep is OFF, no tones will be heard under any condition.

3. POWER LOSS BEEP - Use the '3' key to toggle POWER LOSS BEEP function between ON & OFF. When ON, this function produces four beeps in quick succession at one minute intervals when the following conditions exist:

- The receiver has batteries installed.
- The AC Adapter or other external power source is plugged in but is producing no power.
- The receiver is turned on.
- The loudness of the beeps is a function of the 'VOLUME' control setting.

4. SQUELCH MUTING OFF / ON - Pressing the '4' key toggles between muting ON and OFF. When ON is selected, no audio will be heard from any receiver audio output if the signal strength of the received signal is less than the SQUELCH setting as observed on the Signal Strength meter and the Squelch setting display. If OFF is selected, signals (and noise) will be heard regardless of whether or not they exceed the squelch setting. However, the SQUELCH setting will still be the determining factor for whether or not SEEK or T.SCAN stop on a particular signal, regardless of whether ON or OFF is selected.

5. Unused

6. Unused

7. MAIN MENU - Pressing the '7' key returns the user to the main menu as described previously.

8. MORE - Scrolls forward through available menus as described previously.

9. EXIT - Exits the menu loop and returns to the VFO, MEMORY or COUNTRY.

E1 MENUS continued

SET CLOCKS

This menu is reached from the AUDIO SETTINGS menu described above by pressing the '8' (MORE) key once, or from the MAIN MENU by pressing '3'. It is used to manually set the GMT and Local clocks. It appears as shown in the following illustration.

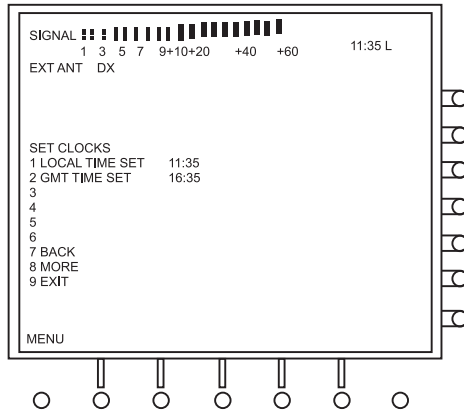

SET CLOCKS

1. LOCAL TIME SET - To set Local time, press the '1' key. This will cause the menu numbers to disappear, and the time numbers in the LOCAL TIME SET row to appear in reverse video. Use the 'Direct-Key-Input' keypad to enter the desired time, ignoring the colon. The time entered should be slightly ahead of the actual time to allow yourself adequate time to make the entry. When the actual local time agrees with the time entered, press the 'STORE' key. You will hear a beep, the clock will start, the menu numbers will return, and the entered time will return to normal video.

2. GMT TIME SET - To set GMT time, press the '2' key and follow the same procedure as described for setting Local time. Example: Set GMT to 13:00 hours

- Press the '2' key. Menu numbers will disappear and the time entry window for GMT TIME SET will appear in reverse video.
- To enter 13:00 hours, press '1', '3', '0', '0' on the 'Direct-Key-Input' keypad.
- When the actual GMT time agrees with the time entered, press 'STORE'.
- You will hear a confirming beep, the clock will start, the entered time will return to normal video, and the menu numbers will reappear.

3. Unused

4. Unused

5. Unused

6. Unused

7. MAIN MENU - Pressing the '7' key returns the user to the main menu as described previously.

8. MORE - Scrolls forward through available menus as described previously.

9. EXIT - Exits the menu loop and returns to the VFO, MEMORY or COUNTRY.

E1 MENUS continued

CLOCK MODES

This menu is reached from the SET CLOCKS menu described above by pressing the '8' (MORE) key once, or from the MAIN MENU by pressing '4'. It is used to set several parameters pertaining to clock, snooze, and timer operation. It appears as shown in the following illustration.

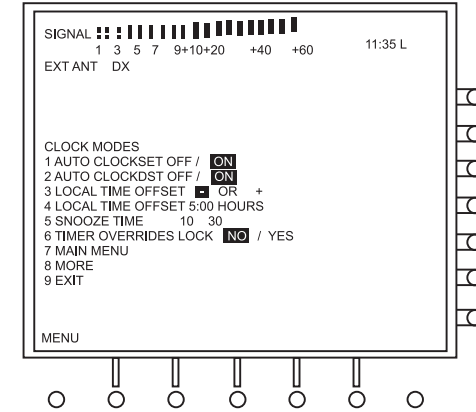

CLOCK MODES

1. AUTO CLOCK SET OFF / ON - Pressing '1' toggles this function OFF and ON. If this feature is ON, the receiver searches the available WWV (or WWVH) National Institute of Standards and Technology frequencies for the best signal. It then uses this signal to set the clocks automatically while the receiver is in the OFF state.

2. AUTO CLOCK DST OFF / ON - Pressing '2' toggles between OFF and ON. When this feature is ON, the receiver automatically sets the Local time to compensate for daylight savings time (DST). When it is disabled, it sets the Local time without daylight savings time compensation, based on the GMT offset, as entered in menu items 3 and 4.

3. LOCAL TIME OFFSET - The '3' key selects between a '+' or a '-' offset of the Local time relative to GMT. The amount of the offset will be the amount entered in menu item '4'. This menu item as well as item 4 can be ignored if you choose to disable AUTO CLOCK SET and set the clocks manually.

4. LOCAL TIME OFFSET - This menu item provides the means of telling the receiver the number of hours of offset of Local time from GMT. For example, if you live in the eastern USA you are in the Eastern Standard time zone, so the offset is minus 5 hours. To enter this information, press '3' until the '-' appears in reverse video. Then press '4'. This will cause a reverse video window to appear on the menu item 4 line, and the menu item numbers will disappear. Use the keypad to enter '5', '0', '0' in this reverse video window. Press the 'STORE' key to enter this information and return the menu item numbers.

5. SNOOZE TIME - Repeatedly pressing the '5' key toggles the SNOOZE time through 5, 10, 20, or 30 minutes. The SNOOZE function is activated by pressing the SNOOZE bar on top of the receiver while the receiver is in the ON state.

6. TIMER OVERRIDES LOCK NO / YES - Pressing '6' toggles between whether or not the timer, when enabled, overrides the locked condition if the radio is locked using the 'CLEAR/LOCK' key.

7. MAIN MENU - Pressing the '7' key returns the user to the main menu as described previously.

8. MORE - Scrolls forward through available menus as described previously.

9. EXIT - Exits the menu loop and returns to the VFO, MEMORY or COUNTRY display.

E1 MENUS continued

TIMERS

This menu is used to set the ON time, OFF time, and associated MEMORY or COUNTRY for timers 1 and 2. It is reached by pressing the '8' (MORE) key from the CLOCK MODES menu or the '5' key from the MAIN MENU. It appears as is shown in the following illustration.

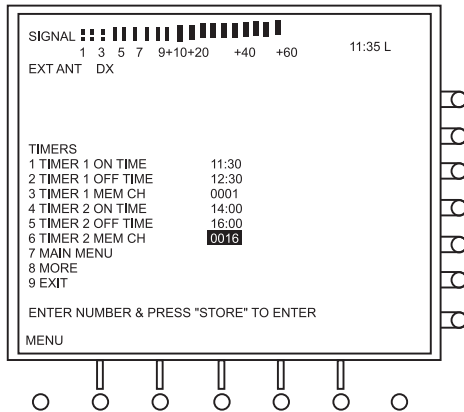

1. TIMER 1 ON TIME - Press '1' to set the start time for timer number 1. When '1' is pressed, the menu numbers will disappear, "ENTER NUMBER & PRESS "STORE" TO ENTER" will appear at the bottom of the display, and the timer 1 start time window will change to reverse video. To set the time, enter the numbers on the 'Direct-Key-Input' keypad. When the numbers have been entered, press the 'STORE' key. This will cause a beep to be heard, the menu numbers will reappear, and the timer 1 start time window will change back to normal video, indicating that the start time has been stored in memory.

Example: Enter a start time of 11:30 for Timer 1

- Press the '1' key. Menu numbers will disappear and the time entry window for Timer 1 will appear in reverse video.
- To enter 11:30 hours, press '1', '1', '3', '0' on the 'Direct-Key-Input' keypad.
- Press the 'STORE' key. You will hear a confirming beep, the entered time will return to normal video and the menu numbers will reappear.

2. TIMER 1 OFF TIME - Press '2' to set the off time for timer 1. Proceed in the same manner as in 1 above.

3. TIMER 1 MEM CH - Using the same technique as in 1 and 2 above, key in the number of the MEMORY or COUNTRY channel that you want the E1 receiver to receive when timer 1 activates.

4. TIMER 2 ON TIME - Press '4' to set the start time for timer number 2.

5. TIMER 2 OFF TIME - Press '5' to set the off time for timer number 2.

6. TIMER 2 MEM CH - Press '6' to set the number of the MEMORY or COUNTRY channel that you want the *etón* E1 to receive when timer 2 activates.

7. MAIN MENU - Pressing the '7' key returns the user to the main menu as described previously.

8. MORE - Scrolls forward through available menus as described previously.

9. EXIT - Exits the menu loop and returns to the VFO, MEMORY or COUNTRY.

E1 MENUS continued

TIMER 1 ENABLE / DISABLE

This menu is used to enable and disable event timer number 1. It is reached by pressing the 'TIME' key once. The ON time, OFF time, and MEMORY or COUNTRY channel shown on this menu must be entered using the TIMERS menu.

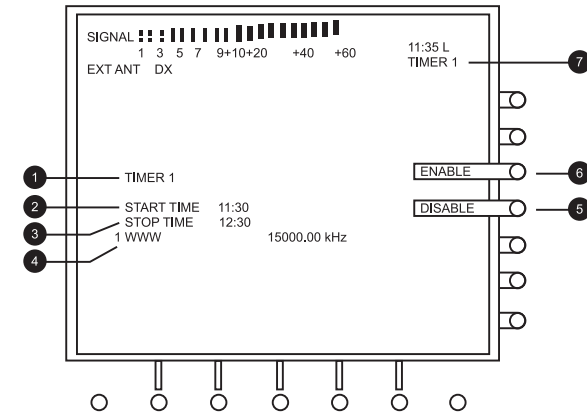

1. TIMER 1 - This display entry identifies this menu as being associated with Timer 1.

2. START TIME - This shows the time that Timer 1 is set up to turn on when enabled.

3. STOP TIME - This shows the time that Timer 1 is set to turn off when enabled.

4. Memory or Country channel selected - This menu entry identifies the MEMORY or COUNTRY channel which was programmed into Timer 1. This is the frequency that will be received when the Timer 1 on time is reached.

5. DISABLE - Press the 'DISABLE' softkey to disable Timer 1.

6. ENABLE - Press the 'ENABLE' softkey to activate Timer 1.

7. TIMER 1 - This display entry will appear when Timer 1 has been enabled. It will be present on all menus and displays as long as Timer 1 is active. If both Timer 1 and 2 are active, it will read "TIMER 1 2". If neither timer is active, it will not be visible on any menu.

E1 MENUS continued

TIMER 2 ENABLE / DISABLE

This menu is used to enable and disable event timer number 2. It is reached by pressing the 'TIME' key a second time. The ON time, OFF time, and MEMORY or COUNTRY channel shown on this menu must be entered using the TIMERS menu. The TIMER 2 ENABLE / DISABLE display appears as shown in the following illustration.

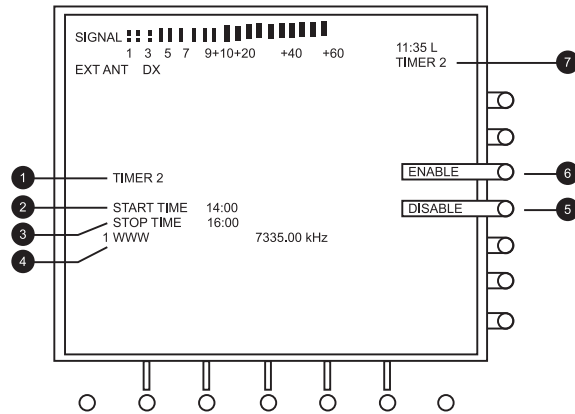

1. **TIMER 2** - This display entry identifies this menu as being associated with Timer 2.
2. **START TIME** - This shows the time that Timer 2 is set up to turn on when enabled.
3. **STOP TIME** - This shows the time that Timer 2 is set to turn off when enabled.
4. **Memory or Country channel selected** - This menu entry identifies the MEMORY or COUNTRY channel which was programmed into Timer 2. This is the frequency that will be received when timer 2 on time is reached.
5. **DISABLE** - Press the 'DISABLE' softkey to disable Timer 2.
6. **ENABLE** - Press the 'ENABLE' softkey to activate Timer 2.
7. **TIMER 2** - This display entry will appear when Timer 2 has been enabled. It will be present on all menus and displays as long as Timer 2 is active. If both Timer 1 and 2 are active, it will read "TIMER 1 2". If neither timer is active, it will not be visible on any menu.

LOCAL / GMT TIME SELECT

This menu is used to select whether the clock displayed on all other displays shows time in GMT or Local time. It is reached by pressing the 'TIME' key a third time. Pressing the 'TIME' key a fourth time takes the user back to the VFO, MEMORY or COUNTRY display, whichever was in use when 'TIME' was pressed initially.

LOCAL / GMT TIME SELECT

This menu is used to select whether the clock displayed on all other displays shows time in GMT or Local time. It is reached by pressing the 'TIME' key a third time. Pressing the 'TIME' key a fourth time takes the user back to the VFO, MEMORY or COUNTRY display, whichever was in use when 'TIME' was pressed initially.

E1 MENUS continued

This display is shown in the following illustration.

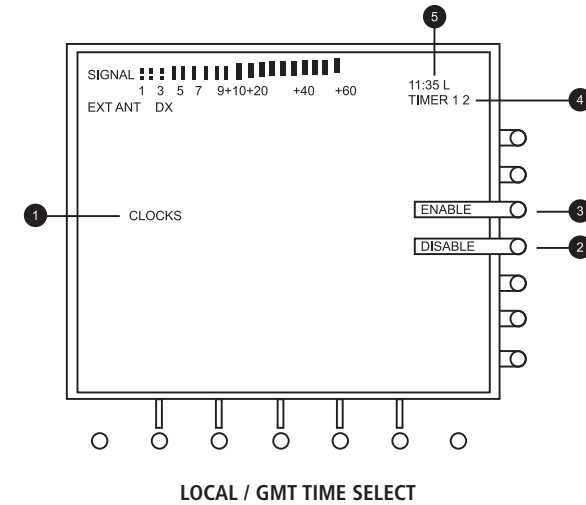

1. **CLOCKS** - This identifies the menu as being the CLOCK GMT / LOCAL selection menu.
2. **LOCAL** - Press this softkey to cause Local time to be shown on all menus and displays.
3. **GMT** - Press this softkey to cause universal (GMT) time to be shown on all menus and displays.
4. **TIMER 1 2** - This indicates that either timer 1, 2, or both are enabled.
5. **L / GMT** - Indicates that the time displayed is either Local (L) or universal (GMT) time.

SEEK FUNCTION

DESCRIPTION

The *etón* E1 incorporates a SEEK function which allows the user to search for signals in VFO, MEMORY or COUNTRY mode which have signal strengths that exceed a predetermined level which the user determines by the setting of the SQUELCH knob.

VFO MODE

To use SEEK in VFO mode, proceed as follows:

- (1) Select the frequency range you would like to scan. This can be FM, MW, LW, or SW.
- (2) Set the SQUELCH control so that the Squelch Level Indicator (located below the signal strength indicator) is set at the desired level.
- (3) Press the 'SEEK' key. The receiver will scan through the selected band in 5 kHz steps on LW band, 9 or 10 kHz steps on MW band, 5 kHz steps on SW band, and 200 kHz steps on FM band. Signals that are strong enough to cause the signal strength indicator display bars to extend further to the right

than the Squelch Level indicator will cause SEEK to stop on that signal, and the signal will be heard.

- (4) The receiver will remain on that signal until the 'SEEK' key is pressed again.
- (5) If the receiver continues to SEEK but cannot find a signal, you may press 'SEEK' again to stop the SEEK.

MEMORY & COUNTRY MODE

To use SEEK in MEMORY and COUNTRY modes, selected frequencies must be programmed into several of the MEMORY and/or COUNTRY channels. Programming of MEMORY channels is covered on page 26 and programming of COUNTRY channels is covered on page 28. Once MEMORY and/or COUNTRY channels are programmed as desired, proceed as follows:

- (1) Press the 'MEMORY' or 'COUNTRY' softkey to enter the desired mode.
- (2) Set the 'SQUELCH' knob to the desired level. (HINT: Set the 'SQUELCH' control high enough (clockwise)

SEEK FUNCTION continued

- that signals breaking the squelch are not noisy.)
- (3) Press the 'SEEK' key. The receiver will step through all programmed MEMORY or COUNTRY locations until it finds a signal that exceeds the squelch setting. It will stop on that signal and will stay there until the 'SEEK' key is pressed again.

T.SCAN FUNCTION

DESCRIPTION

The T.SCAN function of the *etón* E1 allows the user to mark numerous channels in the MEMORY, and/or COUNTRY, memories for selective scanning. Once the channels are marked, pressing the T.SCAN key when in MEMORY or COUNTRY mode will cause the unit to scan through each of the marked channels in that mode, and to stop on each one which has a signal strength greater than a predetermined level which the user determines by the setting of the SQUELCH knob. The user then has two options as to how the T.SCAN will proceed. It can remain on the marked channel as long as the signal level exceeds the SQUELCH setting, or it can remain on the channel for 5 seconds and then resume the scan regardless of signal level. The selection of which of these options is chosen is made from the RADIO SETTINGS menu, item 2 by selecting either TIME or CARRIER. The T.SCAN function works on MEMORY and COUNTRY modes. It does not work on the VFO mode.

Therefore, if T.SCAN is enabled, the scan will proceed through marked channels in CATEGORY or FAVORITES mode, whichever is currently active when the 'T.SCAN' key is pressed, and will remain on each one for approximately five seconds, regardless of whether TIME or CARRIER is selected on the RADIO SETTINGS menu item 2.

MARKING CHANNELS FOR T.SCAN

This discussion assumes that the user has already programmed numerous channels in MEMORY or COUNTRY modes. Programming in MEMORY and COUNTRY modes is covered on pages 26 and 28 respectively.

- (1) Select either MEMORY or COUNTRY mode. The choice will depend entirely on the user's preference and the number of channels programmed in MEMORY or COUNTRY modes.
- (2) Using the 'TUNING' knob or the '< SELECT >' key, scroll through the programmed MEMORY or COUNTRY channels until the reverse video cursor is on the one you want to mark for scan.
- (3) To mark the channel for T.SCAN, press the 'TAG' key. (Number 11 on the Front Panel Description

drawing on page 13.) You will hear a beep tone and see a "T" appear to the left of the channel number.

UNMARKING T.SCAN CHANNELS

- (1) To exclude a marked channel from a T.SCAN, select that channel in MEMORY or COUNTRY modes as described previously.
- (2) With the reverse video cursor on the selected channel, simply press the 'TAG' key again. You will hear a beep tone and see the "T" disappear from the left of the selected channel number.

SELECTING THE SCAN STOP METHOD

- (1) Press the 'MENU' softkey twice to bring up the RADIO SETTINGS menu.
- (2) Note that item 2 on the RADIO SETTINGS menu reads: "2 SCAN STOP MODE TIME / CARRIER" OR "2 SCAN STOP MODE TIME / CARRIER"
- (3) Repeatedly pressing the '2' key on the 'Direct-Key-Input' keypad will cause the reverse video cursor to toggle back and forth between "TIME" and "CARRIER". Leave the cursor on the desired option, and press '9' to exit the menu.
- (4) If "TIME" is chosen, the scan will stop on a channel that has a signal strength that exceeds the SQUELCH setting, will remain there for 5 seconds, and will resume scanning. If CARRIER is chosen, the scan will stop on a carrier that has a signal strength that exceeds the SQUELCH setting, and will remain there until the carrier strength drops below the squelch setting.

INITIATING AND STOPPING THE T.SCAN

- (1) Once desired channels have been marked and the SCAN STOP method has been selected, the T.SCAN can be initiated by pressing the 'T.SCAN' key. This will initiate the scan and will cause the "MEMORY" or "CHANNEL" entry on their respective displays to be replaced with "SCAN"
- (2) To stop a T.SCAN, simply press the 'T.SCAN' key again. This will cause the scan to stop and the "MEMORY" or "COUNTRY" labels on their respective displays to return, replacing "SCAN".

CLOCK AND TIMER FUNCTIONS

TIME DISPLAY

The E1 incorporates dual time clocks allowing two 24 hour clocks to be set and maintained. During loss of AC power, or during battery changing, clock operation is maintained for a period of approximately 10 minutes, if the receiver has been connected to an AC power source or had the batteries installed. The two-event timer functions are also derived from the displayed clock. Therefore the clocks must be set first for proper TIMER operation, and the clock selected for display must be the same one (GMT or Local) for which the timers are programmed.

TIMER settings are stored in non volatile memory and are maintained regardless of how long power has been removed. When the receiver is in the ON state, the time is displayed in the upper right hand corner of the display, regardless of which menu or operating mode is selected. When the receiver is in the OFF state, the time is displayed prominently in the upper portion of the display, and if either timer is enabled, timer settings are displayed in the bottom portion of the display.

If the time in any menu or display is observed to be flashing on and off at one second intervals, this is an indication that the selected clock is not set.

Selecting between Local time and GMT time is accomplished by pressing and releasing the 'TIME' key three times. This will bring up the CLOCKS menu, which allows the user to press the softkey along the right hand side of the display labeled GMT or LOCAL. When the receiver is in the OFF state, pressing the 'TIME' key will toggle between Local and GMT.

SETTING 24 HOUR CLOCKS AUTOMATICALLY

The *etón* E1 has the capability of setting both the GMT and Local clocks automatically. To do this, the receivers must be operating from the AC ADAPTER. Reception must be from one of the five available WWW or WWWH National Institute of Standards and Technology stations with a good quality signal. These stations are located at 2500.0, 5000.0, 10,000.0, 15,000.0, and 20,000.0 kHz. In addition, several items on the CLOCK MODES menu must be set properly. To do this proceed as follows:

- (1) With the receiver turned on, press the 'MENU' soft key which will activate the MAIN MENU. Then press the '4' key on the 'Direct-Key-Input' keypad, to activate the CLOCK MODES menu.
- (2) Item 1 on the CLOCK MODES menu reads: "AUTO CLOCK SET OFF / ON". You will note that either "ON" or "OFF" is shown in reverse video. Pressing '1' on the 'Direct-Key-Input' keypad, will toggle the

reverse video cursor between "ON" and "OFF". If necessary, press the '1' key to move the cursor to "ON".

- (3) Item 2 on the menu reads: "2 AUTO CLOCK DST OFF / ON". Pressing the '2' key on the 'Direct-Key-Input' keypad will toggle the cursor between "OFF" and "ON". You should leave this on "ON" if you live in a location that has daylight savings time (DST). If you live in a location that does not have DST, then you should select "OFF". (DST applies only in North America). Note that automatic update of Daylight Savings Time at the transition date through WWV or WWVH requires a good signal and that the receiver be in the OFF state.
- (4) Item 3 on the menu reads: "LOCAL TIME OFFSET - / +". This refers to whether or not your Local time is less than or greater than GMT. For example, the Western hemisphere is less than GMT and the Eastern hemisphere is greater. Therefore, if you lived in the Western hemisphere, you would use the '3' key to toggle the cursor to '-'
- (5) Item 4 on the menu reads: "LOCAL TIME OFFSET 00:00 HOURS". This refers to how much your Local time is offset from GMT. For example, in the Eastern USA, the time offset is 5:00 hours.
 - To make this setting, press '4' on the 'Direct-Key-Input' keypad. This will cause the menu item numbers to disappear, and the time entry for item 4 to be displayed in reverse video.
 - Use the 'Direct-Key-Input' keypad keys to enter the desired offset, ignoring the colon. For example, for 5:00 hours press '0', '5', '0', '0'. Line 4 of the display will then read: "LOCAL TIME OFFSET 5.00 HOURS".
 - Then press the 'STORE' key to store the entry. You will hear a beep, the menu item numbers will reappear, and the reverse video cursor will disappear.
 - Press the '9' key to exit the menu and return to normal operation.

Note that on the E1, for the clocks to automatically set, the receiver must be receiving power through the AC Adapter and must be in the OFF state. The clocks will not set automatically when operating from batteries. While in the OFF state, it will search for the WWW or WWWH signal that is the strongest, and will then use it to set the clocks. Allow at least 15 minutes for the clocks to set. This could take considerably longer under weak signal conditions.

SETTING THE 24 HOUR CLOCKS MANUALLY

If you are not in a location where adequate signal quality can be obtained on one of the WWW or WWWH signals, the Local and GMT clocks will need to

CLOCK AND TIMER FUNCTIONS continued

be set manually. This is accomplished using the SET CLOCKS menu. To reach this menu, the unit must be in the ON state. Then press the 'MENU' softkey. This will bring up the MAIN MENU. From the MAIN MENU, press the '3' key on the 'Direct-Key-Input' keypad. This will activate the SET CLOCKS menu.

Setting Local Time

- (1) To set the Local time, press the '1' key. This will cause the numbers along the left side of the SET CLOCKS menu to disappear, and the time shown to the left of the 'LOCAL TIME SET' line on the menu to appear in reverse video. Example: " LOCAL TIME SET 00:00"
- (2) Using the 'Direct-Key-Input' keypad, key in the desired time, ignoring the colon. (HINT: Key in a time about one minute ahead of the actual time.) Example: For 16:05, press in sequence '1', '6', '0', '5'. The Local time set line on the display will now appear as: " LOCAL TIME SET 16:05"
- (3) When the actual time agrees with the displayed time, press the 'STORE' key. This will cause a beep, the entered time will now be shown in normal video, the menu numbers will return, and the clock will begin running. Line 1 of the MENU will now look like the following: " 1 LOCAL TIME SET 16:05"
- (4) To exit the SET CLOCKS menu, press the '9' key on the 'Direct-Key-Input' keypad.

Setting GMT Time

Access the SET CLOCKS menu as described in the previous section.

- (1) To set GMT, press the '2' key. This will cause the numbers along the left side of the MENU -CLOCKS menu to disappear, and the time shown to the left of the "GMT TIME SET" line on the menu to appear in reverse video. Example: "GMT TIME SET 00:00"
- (2) Using the 'Direct-Key-Input' keypad, enter the desired time, ignoring the colon. (HINT: Key in a time about one minute ahead of the actual time.) Example: For 21:05, press in sequence '2', '1', '0', '5'. The Local time set line on the display will now appear as: " GMT TIME SET 21:05".
- (3) When the actual time agrees with the displayed time, press the 'STORE' key. This will cause a beep, the entered time will now be shown in normal video, the menu numbers will return, and the clock will begin running. Line 2 of the MENU will now look like the following: " 2 GMT TIME SET 21:05".
- (4) To exit the SET CLOCKS menu, press the '9' key on the 'Direct-Key-Input' keypad.

NOTE: If the AUTO CLOCK SET is left in the ON state,

then manual setting of the clock may result in only a temporary change of the time settings.

TIMER OPERATION

The E1 includes two programmable event timers allowing the receivers to turn ON or OFF at preset times. The timers may be used separately or together and may recall a currently displayed frequency, MEMORY channel, COUNTRY channel, or a combination of those. In addition, programming only an OFF time provides a Sleep timer, and programming only an ON time provides a Wake timer.

Note that the timers, when activated, respond to the last displayed clock. Programming the timers is a three step process. Step one is to set the ON time, and step 2 is to assign the OFF time. Step three is to assign a MEMORY or COUNTRY channel to a timer.

CLOCK AND TIMER FUNCTIONS continued

SETTING TIMER ON/OFF TIMES

Enter the TIMERS menu by pressing the 'MENU' key to reach MAIN MENU, and then pressing the '5' key on the 'Direct-Key-Input' keypad. This brings up the TIMERS menu as shown below.

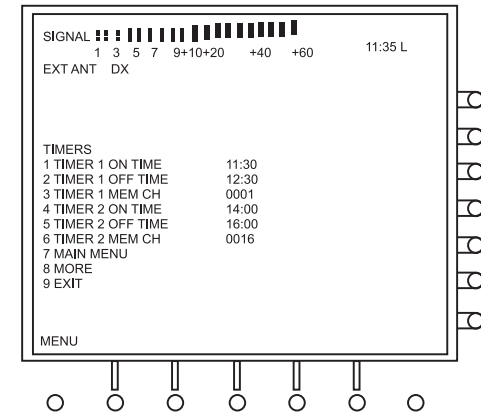

TIMERS

- (1) Press '1' on the 'Direct-Key-Input' keypad. This will cause the menu numbers on the left to disappear and the ON time entry for TIMER 1 will turn to reverse video, as shown here: "TIMER 1 ON TIME 11:30"
- (2) Key in the desired ON time for TIMER 1, ignoring the colon. For example, for an ON time of 18:41, press the following keys: '1', '8', '4', '1'. The TIMER 1 ON TIME cursor will now show "18:41".
- (3) Press 'STORE' to save the TIMER 1 ON time in memory. You will hear a beep, the reverse video window will change to normal video, and the menu numbers will return.

To set the OFF time for TIMER 1, select item 2 from the menu by pressing '2' on the 'Direct-Key-Input' keypad and follow the same procedure as you used to set ON time.

SETTING A WAKE OR SLEEP TIMER

If you want a timer to act as a wake timer only, you would program an ON time and clear an OFF time. This will cause the receiver to turn on at the designated time and stay on until turned off manually.

If you want the timer to act as a sleep timer only, you would clear any existing ON time and program an OFF time. This will cause the receiver to turn off at a designated time and stay off until turned on manually.

To program only an off time, or only an on time, clear the unwanted time on the selected timer as follows:

- (1) Select the timer ON time or OFF time to be cleared by pressing the 'Direct-Key-Input' keypad key corresponding to the menu number of the desired timer ON time or OFF time. This will cause the menu numbers to disappear and a reverse video cursor to appear on the selected timer ON time or OFF time.
- (2) Press the 'CLEAR/LOCK' key on the 'Direct-Key-Input' keypad. This will cause the numbers in the reverse video cursor to disappear. Only the colon will remain.
- (3) Press 'STORE'. This will cause the reverse video cursor to disappear, a beep will be heard, the menu numbers will reappear, and the null time information will be stored in memory.

SETTING TIMER MEMORY CHANNELS

To set the memory channel on the E1 receiver which will be activated by TIMER 1, press '3' on the 'Direct-Key-Input' keypad, and then key in the number of the MEMORY or COUNTRY channel. For example, assume you want TIMER 1 to activate COUNTRY channel 1460.

CLOCK AND TIMER FUNCTIONS continued

- Press '3' for "TIMER 1 MEM CH". You will see a reverse video cursor appear.
- Press '1', '4', '6', '0'.
- You will see "TIMER 1 MEM CH 1460".
- Press the 'STORE' key to save this entry in memory.
- You will hear a beep, the reverse video cursor will go away, the menu numbers on the left will return, and the entered COUNTRY channel will be stored in the TIMER 1 memory.

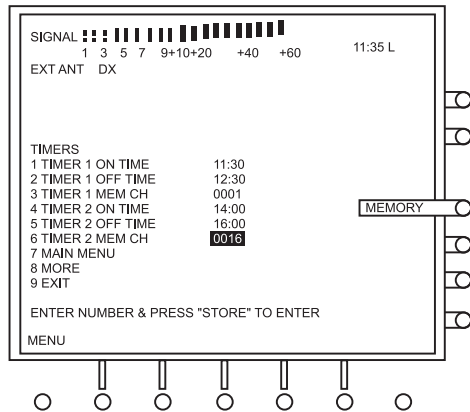

MENU – TIMERS

If it is desired to set TIMER 2, use the same procedure as that for TIMER 1. If you want TIMER 1 or TIMER 2 to turn on the receiver to what ever frequency was tuned in last, simply clear the channel information from the respective TIMER 1 MEM CH or TIMER 2 MEM CH as follows:

- Press the TIMERS menu '3' or '6' as desired on the 'Direct-Key-Input' keypad. This will cause the selected menu line to display a reverse video cursor, and the menu line numbers will disappear. Assuming menu item 3 for TIMER 1 was selected, the line will appear as follows: "TIMER 1 MEM CH 1460".
- Press the 'CLEAR / LOCK' key on the 'Direct-Key-Input' keypad. This will produce a beep and will cause any numbers in the reverse video cursor to disappear.
- Press the 'STORE' key. This will cause another beep, the menu numbers will reappear, the reverse video cursor will disappear, and this null information will be stored in memory. Use this same procedure if you choose to store null information for TIMER 2. To exit the timer menu and go back to a normal operating mode, press '9' on the 'Direct-Key-Input' keypad.

CLOCK AND TIMER FUNCTIONS continued

ENABLING/DISABLING TIMER OPERATION

Press the 'TIME' button. This will activate the TIMER 1 display. It will appear as shown in the "ENABLING/DISABLING TIMER" illustration which follows.

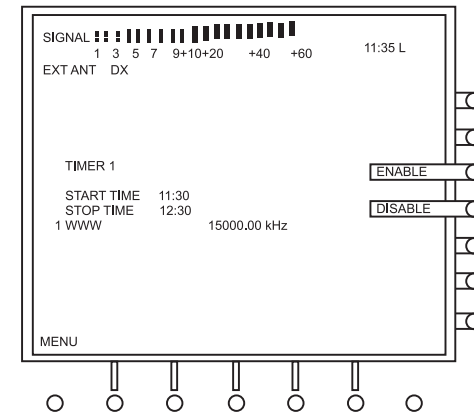

ENABLING/DISABLING TIMER

This display shows the start time and stop time set for TIMER 1 as well as the MEMORY or COUNTRY menu number, frequency, and name (if any) programmed in for the TIMER 1 MEM CH.

To enable TIMER 1, press the 'ENABLE' softkey. This will cause "TIMER 1" to appear in the upper right hand corner of this display (as well as all other displays and menus), indicating that TIMER 1 is enabled.

To disable TIMER 1, press the 'DISABLE' softkey. If TIMER 1 was the only one enabled, "TIMER 1" will disappear from the display. If TIMER 2 was also enabled, only the '1' will disappear. If both timers are enabled you will see "TIMER 1 2" in the upper right hand corner of this and all other displays and menus.

To enable or disable TIMER 2, press the 'TIME' key again. This will activate the TIMER 2 display. This display is identical to the TIMER 1 display except for its name. Follow exactly the same procedure to enable or disable TIMER 2.

To return to normal operation from the TIMER 2 display, press the 'TIME' key twice. The first press will take you to the CLOCKS display, and the second will take you back to the VFO, MEMORY or COUNTRY display. *Note that repeatedly pressing the 'TIME' key will cycle through the TIMER 1, TIMER 2, CLOCKS, and normal screens.*

SPECIAL USE FEATURES AND FUNCTIONS

The *etón* E1 receiver has several special features that are referred to in the main body of this USE AND CARE GUIDE, but may require additional explanation.

LOCK ALL ENTRY TO KEYPAD

The receiver front panel keys with the exception of the 'CLEAR/LOCK' key may be locked or disabled by pressing and holding the 'CLEAR/LOCK' key for 3 seconds. Press the 'CLEAR/LOCK' key and hold for 3 seconds. An acknowledging beep will be heard, and both "LOCK" and "TUN

LOCK" will appear on the front panel display after 3 seconds to indicate that the front panel keys and 'TUNING' control are locked.

Press the 'CLR/LOCK' again for 3 seconds to unlock the front panel keys and 'TUNING' control. The beep will again be heard when the key is pressed and the "LOCK" and "TUN LOCK" indications on the front panel display will disappear after 3 seconds, indicating that the 'TUNING' control and front panel keys have been released.

SPECIAL USE FEATURES AND FUNCTIONS continued

This control can also be used when the receiver is turned off. Press 'CLEAR/LOCK' for 3 seconds. A message will appear confirming lock. If power is then pressed, a "Press CLEAR/LOCK for 3 seconds to unlock" message will appear. The user must perform this action before the 'POWER' key will allow the receiver to be turned on.

BROADCAST BAND TUNING STEP SIZE

In the AM broadcast band, the E1 receiver increments the frequency in 10 kHz steps when pressing the '< SELECT >' keys. The 10 kHz step size is practical for tuning the U.S. and Canadian broadcast bands. However, the step size can be changed to 9 kHz to permit practical tuning of European broadcast stations. The tuning step size is held in nonvolatile memory and thus is not lost during power failure or battery changing.

To select the alternate step size:

Press the 'MENU' softkey to activate the MAIN MENU. Then press '1' on the 'Direct-Key-Input' keypad. This will take you to the RADIO SETTINGS menu. On that menu, item number 4 reads as follows:

"4 MW TUNING STEPS 9 / 10 kHz"

Pressing '4' on the 'Direct-Key-Input' keypad will toggle the reverse video cursor between 9 kHz and 10 kHz. Leave the cursor on the desired MW band step size. If the step size was 10 kHz prior to performing the above procedure, then the 9 kHz step size for the broadcast band is now programmed. To change back to 10 kHz, repeat the same procedure. To exit the RADIO SETTINGS menu, press '9' (EXIT) on the 'Direct-Key-Input' keypad.

DELETE ALL MEMORY OR COUNTRY CHANNELS

The following procedure will delete either all MEMORY or all COUNTRY channels.

- Place the receiver in either MEMORY or COUNTRY mode by pressing the 'MEMORY' or 'COUNTRY' softkeys.
- Press 'POWER' to power down the receiver.
- Press the 'POWER' key again and hold.
- While holding the 'POWER' key, press the 'MEMORY' or 'COUNTRY' softkey for two seconds.
- This will cause the message "DELETE PAGE ?" to appear on the display. You can now release the keys.
- If you hadn't already pressed 'MEMORY' or 'COUNTRY' you can do so now.
- While the "DELETE PAGE ?" message is still visible, press the 'DELETE' key for two seconds to delete the page.

Note that if the "DELETE PAGE ?" message disappears from the display before you press the 'DELETE' key, you

must start over.

DELETE ALL MEMORY AND COUNTRY CHANNELS

If it is desired to delete all MEMORY AND COUNTRY channels in one operation, proceed as follows:

- Place the receiver in either MEMORY or COUNTRY mode by pressing the 'MEMORY' or 'COUNTRY' softkey.
- Turn the receiver off by pressing the 'POWER' key.
- Press and hold the 'POWER' key.
- Press the 'DELETE' key for two seconds while still holding down the 'POWER' key.
- This will cause the message "Are you really sure you want to delete the program information in all 1700 memory channels?" to appear.
- While this message is still displayed, press the 'DELETE' key for two seconds to clear MEMORY and CHANNEL memories.

DISPLAY LIGHTING

With AC Adapter

When the unit is operating from the external AC adapter or other DC power source and is turned OFF, the display lighting will revert to one of the following states.

- If Dim, Medium, or Bright was selected using the 'LIGHT' key when the unit was ON, the display will be Dim when the unit is turned OFF.
- If no backlighting was selected using the 'LIGHT' key when the unit was ON, the display will not be illuminated when the receiver is turned OFF.
- When the receiver is in the OFF state, the display illumination can be toggled on and off with the 'LIGHT' key. If toggled on, the illumination will remain on indefinitely.

Regardless of display lighting, the LCD display will remain ON, displaying the time indefinitely, and can be switched between Local and GMT time using the 'TIME' key.

With Batteries Only

When the receiver is turned OFF when operating from batteries the display lighting will do one of the following.

- If Dim, Medium, or Bright was selected using the 'LIGHT' key when the unit was ON, the display will be Dim when turned OFF, and will remain lit displaying Local or GMT time for ten seconds, after which both the Dim lighting and the LCD "TIME" display will turn off.
- If no backlighting was selected using the 'LIGHT' key when the unit was ON, the display will not be illuminated when the receiver is turned OFF. The LCD display will show Local or GMT time for ten seconds and then turn OFF.

SPECIAL USE FEATURES AND FUNCTIONS continued

- Pressing the 'LIGHT' key when the receiver is OFF will cause the display illumination to be toggled between being on and off. The LCD display and any illumination will turn off after 10 seconds. When the unit is OFF, pressing the 'TIME' key once will activate the LCD "TIME" display and additional presses of the 'TIME' key will cycle the "TIME" display between Local and GMT. If any display illumination was selected when the unit was last in the ON state, Dim display lighting will be turned on with the first press of the 'TIME' key along with the LCD display. Both illumination and the LCD display will turn OFF ten seconds after the last press of the 'TIME' key. When the receiver is ON, and either Dim, Medium, or Bright backlighting is selected, the illumination will turn OFF ten seconds after the last control input. Changing any control setting other than 'SQUELCH', 'TREBLE', 'BASS', or 'VOLUME' will cause the display to come back ON and remain ON for ten seconds after the last control setting change and then turn back OFF. This "time out" feature can be disabled by holding down the

'LIGHT' key for three seconds. You will hear a confirming beep. This will cause the illumination to stay ON until the receiver is turned OFF. However, the user should keep in mind that this mode of operation will result in a considerable reduction in battery life. The illumination timeout feature can be re-enabled in one of two ways.

- Hold down the 'LAMP' key for three seconds. A beep will be heard, confirming that the feature has been enabled.
- Turn the receiver 'POWER' OFF and back ON.

QUICK REFERENCE GUIDE

QUICK REFERENCE GUIDE	
The  symbol indicates that the key is to be pressed within three seconds.	
Select normal frequency display (VFO) (page 19 item 20)	<ul style="list-style-type: none"> Press 'VFO'
Select normal frequency display (VFO) (page 19 item 21, 22, 23)	<ul style="list-style-type: none"> Press 'FM', SW, MW or LW softkeys to select FM Broadcast, Shortwave, AM Broadcast or Long Wave bands. When in Shortwave mode, press 'SW' two or three digit entry from 'Direct-Key-Input' keypad for Shortwave Meter band designation.
Adjust Frequency (page 21)	<ul style="list-style-type: none"> Select Band. Turn 'TUNING' knob, Press '< SELECT >' keys, use 'Direct-Key-Entry' keypad.
Select Mode (page 22-25)	<ul style="list-style-type: none"> Press 'AM' for displayed 'AM' Press 'AM' again to toggle to 'AM SYNCH' Press 'SSB' to scroll between 'USB', 'LSB' and DSB when 'AM SYNCH' is displayed. Press 'FM' as required to display 'FM'. Press 'SSB' to select SSB mode. (AM SYNC must be off. To turn off, press AM).
Select AM SYNC (page 23)	<ul style="list-style-type: none"> With unit in 'AM' mode, press 'AM' again. 'AM SYNC' will flash and then lock on.
Select Bandwidth (page 19, item 13)	<ul style="list-style-type: none"> Press 'BW' for displayed '7.0', '4.0' or '2.3' kHz (not active in FM).
Select AGC (page 19, item 12)	<ul style="list-style-type: none"> Press 'AGC' for displayed 'SLOW', 'FAST', or AUTO (not active in FM).
DX (preamplifier) On or Off (page 15 item 16)	<ul style="list-style-type: none"> Press 'DX' for displayed 'DX' or blank.
Set Time (page 52)	<ul style="list-style-type: none"> Press 'MENU' to display MAIN MENU. Then press '3' to display SET CLOCKS display. Press '1', set Local time using keypad, and press STORE to start clock. Press '2', set GMT time using keypad and press 'STORE' to start clock. Press '9' to exit SET CLOCKS display
Display GMT or Local Time (page 48)	<ul style="list-style-type: none"> Press 'TIME' key 3 times. Press GMT or LOCAL softkey to select. Press 'TIME' key again to exit menu. Time is always displayed in upper right corner when on, and in center of display when off.

Quick Reference Guide continued >>>

QUICK REFERENCE GUIDE continued

Program ON/OFF timers (starting 53)	<ul style="list-style-type: none"> Press MENU to activate MAIN MENU Press '5' to activate TIMERS menu. Press '1' and set TIMER 1 ON time using Keypad. Press 'STORE' to save. Press '2' and set TIMER 1 OFF time using keypad. Press 'STORE' to save. Press '3' and set TIMER 1 Memory Channel using keypad and press 'STORE' to save. Repeat for TIMER 2 using menu entries 4, 5, and 6. Press '9' to exit menu.
Activate (Enabling) Timer (page 56)	<ul style="list-style-type: none"> Press 'TIME' to activate TIMER 1 menu. Press 'ENABLE' to activate. Press 'TIME' again to activate TIMER 2 menu. Press 'ENABLE' to activate. Press 'TIME' again twice to return to normal operation. TIMER 1 and/or 2 will be displayed below the clock to indicate activation.
Lock (or Unlock) Controls (page 56)	<ul style="list-style-type: none"> Press and hold 'CLR/LOCK' until "LOCK" is displayed (extinguishes). Pushbuttons (except POWER) and 'TUNING' knob are inactive (active).
Display light On/Off (page 57)	<ul style="list-style-type: none"> Press 'LIGHT' to scroll display lighting through bright, medium, dim and off.
Disable Beep (page 25)	<ul style="list-style-type: none"> Press 'MENU' to enable MAIN MENU. Press '2' to enable the AUDIO SETTINGS menu. Press '2' to toggle Beep on and off. Press '9' to exit menu.
MEMORY FUNCTIONS	<ul style="list-style-type: none"> Select frequency, bandwidth, AGC and mode. Press 'STORE'. This will activate MEMORY or COUNTRY memory mode. Press MEMORY or COUNTRY to select your preference. Select an empty location using 'TUNING' or '< SELECT >'. Press 'STORE' to save. If in MEMORY mode, use 'TUNING' and '< SELECT >' to assign name, and press STORE again.
<ul style="list-style-type: none"> Recall MEMORY Channel (page 26) Recall COUNTRY Channel (page 28) 	<ul style="list-style-type: none"> Press 'MEMORY' or 'COUNTRY'. Use 'TUNING' and/or '< SELECT >' to select desired memory channel.
Select MEMORY or COUNTRY Channel for T.SCAN (page 51)	<ul style="list-style-type: none"> Recall a MEMORY or COUNTRY channel as above. Press 'TAG' to mark the channel for T.SCAN. Set SQUELCH to desired level. Press 'T.SCAN' to activate scan.
<ul style="list-style-type: none"> Delete a MEMORY Channel (page 28) Delete a COUNTRY Channel (page 30) 	<ul style="list-style-type: none"> 'Select a MEMORY or COUNTRY channel to delete as described above. Press and hold 'DELETE' for 3 seconds. A high pitched beep will be heard and listed channel will be deleted.

Quick Reference Guide continued >>>

QUICK REFERENCE GUIDE continued

Delete all MEMORY and COUNTRY Channels (page 57)	<ul style="list-style-type: none"> • Press 'MEMORY' or 'COUNTRY'. • Turn off with 'POWER' key. • Press & hold 'POWER' key & press 'DELETE' for 2 seconds. • When warning appears, release 'DELETE' & press it again for 2 seconds. • This will clear all memory locations.
Mark Channels for T.Scan (page 51)	<ul style="list-style-type: none"> • Select either MEMORY or COUNTRY. • Select the MEMORY or COUNTRY channel to be marked using • TUNING knob or the < SELECT > key. • Press the 'TAG' key to mark the channel.
T.SCAN MODE - The scan feature only works with channels programmed with a 'T' as described above. T.SCAN FUNCTION (page 51)	<ul style="list-style-type: none"> • Select MEMORY or COUNTRY mode. • Set SQUELCH to desired level. • Press T.SCAN to begin scan. • Press T.SCAN again to stop scan.
SIDE PANEL CONTROLS HF Antenna Select (page 20)	<ul style="list-style-type: none"> • Set ANTENNA - HF Internal/External switch as appropriate for antennas available.
FM Antenna Select (page 20)	<ul style="list-style-type: none"> • Set ANTENNA - FM Internal/External switch as appropriate for antenna available.

GLOSSARY OF TERMS

AC Input - Alternating Current power source available at wall outlet sockets.

AM - Signals in which the information is conveyed by amplitude changes of the signal. Amplitude Modulation is used for the AM broadcast bands.

AGC - Automatic Gain Control which is employed in receivers to adjust the amount of gain in the receiver's circuitry to prevent distortion and maintain a nearly constant audio volume level over wide variations in received signal strength.

CW - Continuous Wave transmission signals. Actually, the signal is keyed on and off at precise intervals to convey information. Morse code is the most common CW signal.

DC Input - Direct Current power source such as is available from batteries or regulated power supplies.

DX - Refers to stations which are unusually distant from the receiver and are therefore frequently difficult to receive. In the context of this manual, DX refers to a built in preamplifier, which, when enabled, makes these "DX" stations more readable.

Dynamic Range - Ability of the receiver to faithfully reproduce high quality audio over a wide range of signal strength conditions - from very weak signals to very strong signals.

Frequency - Rate of reoccurrence in hertz or cycles per second of electromagnetic wave or carrier.

FM - Signals in which the information is conveyed by frequency changes of the signal. Frequency Modulation is used for the FM broadcast bands.

Electronically Switched Filter - A multi bandwidth filter with high adjacent channel attenuationswitched electronically.

GMT - Greenwich Mean Time.

HF - High Frequency band. This consists of the LW, MW, and SW bands on the E1 receiver.

LCD - Liquid-Crystal Display - Low power consumption displays used for wristwatches and information displays on many types of electronic equipment.

LSB - Lower Side Band - The lower frequency portion, excluding the carrier, of an AM signal. A single-side-band signal, in this case the lower sideband, contains all of the modulation information of amplitude modulation in one half the bandwidth.

RF - Radio frequency

RTTY - Radio Teletype communications.

Softkeys - Keys surrounding the display that have different functions under different conditions. The current function of each individual softkey is shown on the display.

Squelch - A user controlled adjustment which mutes the audio output below a certain signal strength.
Synchronous Detector - An amplitude modulation detector which utilizes a replica of the original transmitted carrier signal to improve the reception of weak signals.

Synthesized - Capable of generating a large number of different output frequencies, all related to a single, highly stable reference source.

USB - Upper Side Band - The higher frequency portion, excluding the carrier of an AM signal. A single side-band signal, in this case the upper sideband, contains all of the modulation information of amplitude modulation in one half the bandwidth.

UTC - Universal Time Coordinated.

VFO - Variable Frequency Oscillator.

VHF - Very High Frequency band extends from approximately 30 MHz to 300 MHz.

TROUBLESHOOTING

Problem	Probable Cause	Solution
No front panel display or light.	(A) Power connection. (B) Defective AC ADAPTER unit. (C) Batteries are discharged or not installed for portable operation, no AC power. (D) Light turned off with 'LIGHT' key.	(A) Check power supply cables. (B) Check AC ADAPTER. (C) Check/install batteries for portable operation. (D) Turn light on with 'LIGHT' key.
No signals heard when antenna is connected or sensitivity is low.	(A) Incorrect antenna input selected. (B) Squelch set too high.	(A) Select correct antenna input. (B) Set Squelch to lower level.
Signal Strength indication but no sound heard.	(A) Improper mode selected. (B) External speaker connected but defective. (C) Squelch set too high.	(A) Check mode selection. (B) Check external speaker. (C) Set Squelch to lower level.
No front panel operation such as tuning, frequency entry, etc.	(A) Lock enabled.	(A) Press 'CLEAR/LOCK' and hold for 3 seconds to unlock front panel.
Timer does not operate.	(A) Clock(s) not set. (B) Timer not properly set. (C) Alternate clock selected. (D) Timer(s) not enabled.	(A) Set clock(s). (B) Set clock(s) and program timer ON/OFF times. (C) Check that last displayed clock is the desired one for timer event. (D) Enable timers. Observe TIMER 1 or 2 on display.

SERVICE INFORMATION

You may contact **etón** Corporation Service Department for additional information or assistance by calling toll-free Monday through Friday, 8:30am -4:00pm Pacific Standard Time:

1(800) 872-2228 (US)
1(800) 673-1648 (CN)
650-903-3866 (World-wide)

Call for a Return Authorization prior to shipping your unit. Should you want to return your unit for service,

pack the receiver carefully using the original carton or other suitable container. Write your return address clearly on the shipping carton and on an enclosed cover letter describing the service required, symptoms or problems. Also, include your daytime telephone number and a copy of your proof of purchase. The receiver will be serviced under the terms of the **etón** Corporation Limited Warranty and returned to you.

ONE YEAR LIMITED WARRANTY

etón warrants to the original purchaser this product shall be free from defects in material or workmanship for one year from the date of original purchase.

During the warranty period **etón** or an authorized **etón** service facility will provide, free of charge, both parts and labor necessary to correct defects in material and workmanship. At their option, **etón** may replace a defective unit.

- (1) Complete and send in the Warranty Registration Card within ten (10) days of purchase.
- (2) Call **etón** or the nearest authorized service facility, as soon as possible after discovery of a possible defect. Have ready:
 - (a) the model and serial number.
 - (b) the identity of the seller and the approximate date of purchase.
 - (c) a detailed description of the problem, including details on the electrical connection to associated equipment and the list of such equipment.
- (3) **etón** will issue a Return Authorization number and the address to which the unit can be shipped. Ship the unit in its original container or equivalent, fully insured and shipping charges prepaid.

Correct maintenance, repair, and use are important to obtain proper performance from this product. Therefore carefully read the Instruction Manual. This warranty does not apply to any defect that **etón** determines is due to:

- (1) Improper maintenance or repair, including the installation of parts or accessories that do not conform to the quality and specification of the original parts.

- (2) Misuse, abuse, neglect or improper installation.
- (3) Accidental or intentional damage.
- (4) Battery leakage.

All implied warranties, if any, including warranties of merchantability and fitness for a particular purpose, terminate one (1) year from the date of the original purchase. The foregoing constitutes **etón** Corporation entire obligation with respect to this product, and the original purchaser shall have no other remedy and no claim for incidental or consequential damages, losses, or expenses. Some states do not allow limitations on how long an implied warranty lasts or do not allow the exclusions or limitation of incidental or consequential damages, so the above limitation and exclusion may not apply to you. This warranty give you specific legal rights and you may also have other rights, which vary from state to state.

For service information contact:

etón Corporation
1015 Corporation Way
Palo Alto, CA 94303
USA

APPENDIX

UNDERSTANDING SHORTWAVE BANDS - THE KEY TO SUCCESSFULLY USING YOUR SHORTWAVE RADIO

Do You Need Help?

Monday-Friday, 8:30 a.m. - 4:00 p.m.,
North American Pacific Time.

1-800-872-2228 from the U.S.
1-800-637-1648 from Canada
1-650-903-3866, worldwide
FAX: 650-903-3867
customersvc@etonicorp.com
www.etonicorp.com

Mailing Address:
etón Corporation
1015 Corporation Way
Palo Alto, CA 94303
USA

WHAT IS SHORTWAVE?

Now that you have a shortwave radio, no doubt you'll want to hear worldwide stations right away. What is shortwave? What will you hear? Shortwave is a broadcast frequency range that allows stations' signals to be heard over vast distances, usually thousands of miles. You'll hear news and information along with culturally oriented programming, sometimes including music. The programming may or may not be biased or propagandized. If you're new to shortwave, please take some time to learn the basics outlined below. To successfully listen to shortwave stations you must know how to find them. They are found in the shortwave bands. If you're an experienced shortwave listener, you'll know what bands are and how to use them, but if you're new, you'll need to learn about bands first. After that you will have excellent success. Please read on.

SOME BASIC RULES OF THUMB

- Night shortwave reception is usually better than daytime shortwave. This can change from time-to-time, so it's worth checking the bands during the day as well.
- Shortwave is usually better in the winter than other times of year.
- Typically, the best daytime shortwave bands are 13, 15, 16, 19, and 22 meters, 16 and 19 usually the best. At night, the best bands are 25, 31, 41 and 49

meters, with 31 and 49 usually best.

- Around sunset and sunrise, both the day and night bands may often be exceptionally good, often making listening at these times quite rewarding.
- Because the construction materials of some buildings severely block shortwave signals, it may be best to hold the radio in your hands and get very close to a window or use an external antenna mounted next to the window or outside.

WHAT ARE BANDS?

This is the most important concept to learn right away. If you have ever listened to AM or FM radio, then you already know what a band is. The AM band is a frequency range stretching from 530 to 1600 kilohertz, the FM band is 66-108 megahertz. A band is a frequency range where stations are located. When looking for stations in these 'bands', you tune around with your tuning buttons (or the tuning knob on an analog radio) until you find a station you like. Shortwave is similar and the shortwave bands have names like 25 meters, 31 meters, 49 meters, etc. These are abbreviated 25m, 31m and 49m. Just like in AM and FM radio, one simply gets into the shortwave band and tunes around, looking for stations. Each band represents a frequency range, as shown

in the band chart below. For example, the 19 meter shortwave band encompasses the frequency range of 15100 to 15600 kilohertz. Since some radios show frequency in megahertz (MHz) and some in kilohertz (KHz), both are shown here. Look at your radios tuning scale or its digital display to determine frequency designation it uses in shortwave. On some shortwave radios these frequencies will look like 15100 KHz, 15105 KHz or 15110 KHz and on other radios they might look like 15.1 MHz, 15.105 MHz or 15.11 MHz. The exact frequency ranges for these bands may vary somewhat from one radio model to another. This is perfectly OK. On some radios the band names, e.g. 19 meters, are clearly marked, on others they are not marked at all. If it is not apparent how to get into a band on your radio, consult the owner's manual.

A HELPFUL ANALOGY ABOUT BANDS

A shortwave band is like a street with many addresses on it. In this case, the individual addresses are called frequencies, each one a potential home of a broadcaster. For example, in the 19 meter band (it could be called 19 Meter Street), 15110 kilohertz is the home of Radio Spain International, 15190 is the home of BBC World Service and 15275 is the home of Deutsche Welle (Germany). As on any street, the occupants at a specific address are not always at home.

APPENDIX - UNDERSTANDING SHORTWAVE BANDS continued

BAND	MEGAHERTZ (MHz)	KILOHERTZ (KHz)
120 Meter	2.300 - 2.500 MHz	2300 - 2500 KHz
90 Meter	3.20 - 3.40 MHz	3200 - 3400 KHz
75 Meter	3.90 - 4.00 MHz	3900 - 4000 KHz
60 Meter	4.750 - 5.060 MHz	4750 - 5060 KHz
49 Meter	5.950 - 6.20 MHz	5900 - 6200 KHz
41 Meter	7.10 - 7.60 MHz	7100 - 7600 KHz
31 Meter	9.20 - 9.90 MHz	9200 - 9900 KHz
25 Meter	11.600 - 12.100 MHz	11600 - 12,100 KHz
22 Meter	13.570 - 13.870 MHz	13570 - 13,870 KHz
19 Meter	15.10 - 15.80 MHz	15100 - 15,800 KHz
16 Meter	17.480 - 17.90 MHz	17480 - 17,900 KHz
13 Meter	21.450 - 21.850 MHz	21450 - 21,850 KHz
11 Meter	25.60 - 26.10 MHz	25600 - 26,100 KHz

DAY BANDS vs. NIGHT BANDS - it's important

Because shortwave signals depend on such factors as the sun, the ionosphere and interaction with the earth itself, signals cannot be heard on all bands throughout the day. Some bands are best during the daylight hours, and some are best at night. In general, the bands with frequencies below 13 MHz (13000 KHz) are better at night and the bands with frequencies above 13 MHz (13000 KHz) are best during the day. Follow these guidelines for best listening results.

SUNSET AND SUNRISE - often the best time to listen.

This is when shortwave signals are often strongest and clearest, in a window of time around sunset and sunrise. Sometimes it's a two-hour window, at other times three or four hours. Experiment to determine when it's best in your area.

DAYTIME LISTENING

Shortwave listening is generally at its poorest during the daylight hours of about 10 a.m. to 3 p.m. The major reason for this is that the broadcasters are not transmitting to regions at this time, assuming that we are all either at work or at school and are not able to listen during the day. In North America, daytime shortwave tends to be better in the East and Midwest. The day bands are 13, 16, 19, 22 and 25 meters, often with 16 and 19 being the best. In the summer, these bands may stay open into the evening hours.

EVENING/NIGHT LISTENING

This is the best time to listen, because the broadcasters are deliberately transmitting to you, wherever you are, at least up to about 11 pm. These bands may be extremely good around sunset and sunrise too. The night bands are 25, 31, 41, 49 and 60 meters. In the winter, these bands produce results earlier than in the

summer months, often starting around 3 pm on 25 and 31 meters and 5 pm on 41, 49 and 60 meters. In the summer these bands start later, around 5 pm for 25 and 31 meters and around 7 pm for 41, 49 and 60.

IMPORTANT NOTE: Getting close to a window may substantially improve reception. Shortwave signals penetrate wood frame buildings easiest, while concrete and brick buildings usually block signals. If you are in a building with one or more stories above you, signals can also be impaired in strength. In such a situation, position yourself, and especially the radio's antenna, as close to a window as possible while listening. Use an external antenna if necessary.

SHORTWAVE DIRECTORY

We recommend the use of a comprehensive shortwave directory, especially to seek specific countries or to determine what you're listening to. Such a directory lists the countries broadcasting on shortwave, showing their language, target area, broadcast time and frequency that is used. A frequency-by-frequency listing help to determine what is being heard. The two such directories listed below are found in major bookstores, on-line bookstores. Internet sources of shortwave broadcast information can be found via your favorite search site by searching for 'shortwave broadcast schedules'.

PASSPORT TO WORLD BAND RADIO,

WORLD RADIO TV HANDBOOK.

SHORTWAVE ANTENNAS

An external shortwave antenna, especially when mounted outside, can greatly enhance reception. If your shortwave radio has an antenna socket, professionally engineered antennas can usually be used. **etón** Corporation does not manufacture or sell shortwave antennas, however, there are many excellent models available to significantly enhance your shortwave reception.

NOTE: When ordering any antenna, let the retailer know what radio it's for and that you want the proper plug fitting or adaptor installed on the coaxial cable for your model, or else the antenna's coax cable won't plug into the radio's antenna socket. This may cost a few dollars more, but it's well worth it and saves you time if such fittings and adaptors are not available from a local store in your area.

APPENDIX - UNDERSTANDING SHORTWAVE BANDS continued

FULL-SIZED PASSIVE SHORTWAVE ANTENNAS

These normally give the best performance. Generically they have names such as dipoles, trapped dipoles, parallel dipoles and slopers. They are characteristically fed with 50 or 75 ohm coaxial cable that leads to the radio's antenna socket. Even if you build one of these using instructions from a book, these antennas are an 'engineered system', thus optimizing performance.

ACTIVE SHORTWAVE ANTENNAS (usually small)

Active antennas are much smaller than others and employ the use of amplifiers to compensate for their small size. There are many models to choose from. They usually do not perform as well as passive or non-amplified, professionally engineered models but are useful when a short, small size is needed.

SHORTWAVE ANTENNAS FOR USE ON BOATS

RF Systems makes the model MARINE BALUN KIT (about \$90 USD), which can turn a backstay or a long piece of wire into an efficient shortwave receiving antenna. McKay Dymek makes the model DA-100EM (about \$200 USD), mountable on a mast or railing, the antenna being only about 1.5 meter high (4 ft. 8 in.).

LONG-WIRE SHORTWAVE ANTENNAS

If your radio does not have an antenna socket, or if you want to take a simpler or less costly approach, this type of antenna can improve signal levels. Understand, however, that this is not an engineered system and noise

levels may still be quite high. Such antennas are attached directly to the radio's telescopic antenna with an 'alligator' clip or other secure attachment device.

AM ANTENNAS

We are often asked about AM antennas. Such antennas, usually AM-Loop antennas, are made by a variety of manufacturers and often work extremely well to boost signals. One brand, Select-A-Tenna, is a time-proven performer and includes models ranging from about \$60-\$200.

FINDING ANTENNAS

One way to find antennas is by performing a search on the Internet.

APPENDIX - UNDERSTANDING SHORTWAVE BANDS continued

GETTING STARTED WITH SINGLE SIDEBAND (SSB)

Many high-end shortwave radios have a feature called SSB, a highly efficient way of electronically processing transmitted and received signals for two-way communication. Examples of this are amateur radio (hams), maritime and aeronautical communication. Either upper side band (USB) or lower side band (LSB) can be used.

Receiving SSB signals is not always easy. Since this is two-way communications, transmissions are often very short and sporadic. Also, most two-way communica-

tions uses relatively low power, 50 to 1000 watts. The amateur radio operators are easiest to find; the others can be very difficult. Best results are experienced when using an outdoor shortwave antenna such as a dipole. Finding SSB signals can be like seeking a "needle in a haystack", so be patient! The easiest place to find SSB communications is at night in the amateur band shown below at 3650-4000 kHz. Follow your radio's instructions on how to engage its SSB feature. Below are some selected frequency ranges on which SSB communications can be found. All frequencies are shown in kilohertz.

Amateur Radio	Aeronautical (usually USB)	Aeronautical (usually USB)	Maritime (usually USB)
80m: 3650-4000, LSB, night.	2850-3155	15010-15100	4063-4438
40m: 7150-7300, LSB, day/night.	3400-3500	17900-18030	6200-6525
20m: 14150-14350, USB, day.	4650-4750	21870-22000	8195-8815
15m: 21150-21450, USB, day.	5480-5730	23200-23350	12230-13200
10m: 28300-28600, USB, day.	6525-6765		16360-17410
	8815-9040		18780-18900
	10005-10100		19680-19800
	11175-11400		22000-22720
	13200-13360		25070-25110

TIME STATIONS		
CHU-time (Canada)	3,330 kHz	Best at night
CHU-time(Canada)	7,335 kHz	Day/night
CHU-time (Canada)	14,670 kHz	Best during daylight
WWV-time/weather(US)	2,500 KHZ	Best at night
WWV-time/weather(US)	5,000 KHz	Best at night
WWV-time/weather(US)	10,000 kHz	Day/night
WWV-time/weather(US)	15,000 kHz	Best during daylight
WWV-time/weather(US)	20,000 kHz	Best during daylight

TIME STATIONS not SSB		
CHU-time (Canada)	3,330 kHz	Best at night
CHU-time(Canada)	7,335 kHz	Day/night
CHU-time (Canada)	14,670 kHz	Best during daylight
WWV-time/weather(US)	2,500 KHZ	Best at night
WWV-time/weather(US)	5,000 KHz	Best at night
WWV-time/weather(US)	10,000 kHz	Day/night
WWV-time/weather(US)	15,000 kHz	Best during daylight
WWV-time/weather(US)	20,000 kHz	Best during daylight

APPENDIX - *etón* E1 QUICK GUIDE

Do You Need Help?

Monday-Friday, 8:30 a.m. - 4:00 p.m.,
North American Pacific Time.

1-800-872-2228 from the U.S.
1-800-637-1648 from Canada
1-650-903-3866, worldwide
FAX: 650-903-3867
customersvc@etonc.com
www.etonc.com

Mailing Address:

etón Corporation
1015 Corporation Way
Palo Alto, CA 94303
USA

INTRODUCTION

This Quick Guide outlines the basics for listening to AM, FM and Shortwave. It also covers setting the clock and timers and storing stations into memory. Not all features and capabilities of the E1 are addressed here. We encourage you to refer to the owner's manual for a full understanding of the E1.

SET-UP INFORMATION

Power the E1 with the AC adaptor or insert 4 new, identical alkaline D size batteries of the same brand and type (never intermix non-identical batteries). The battery compartment is accessed via the outer and inner door on the lower left front of the E1. When inserting 4 D alkaline batteries, follow the battery polarity diagram printed on the inner door. Turn the E1 and off by pressing the POWER button.

For FM and Shortwave reception, pull up the telescopic antenna.

The buttons (also called keys), knobs and switches referred to in this Quick Guide can be found by carefully looking at the radio. Some of the buttons (also called 'keys') are located surrounding the display (LCD). The function of these buttons is defined within the LCD. Full descriptions of controls and their locations are found in owner's manual pages.

Note that the AM broadcast band, 520-1710 KHz, is designated as MW (Medium Wave) in the display and in all explanations. While using this Quick Guide, set the SQUELCH knob fully counterclockwise, assure that both ANTENNA switches are in the INTERNAL position and use the DX button to assure that DX appears in the upper left area of the display.

If reception is poor, get very close to a window. The construction materials of some buildings block signals.

TUNING-IN FM AND MW STATIONS

Stations are tuned-in with the SELECT button, the TUNING knob, by Direct Frequency Entry (see below) or the SEEK key (see below). If you are in Europe, the Middle East or in the Mediterranean area, LW stations can also be accessed (there are no LW broadcast stations in the Americas).

USING DIRECT FREQUENCY ENTRY

Direct frequency entry is performed by pressing the numbered keys and can be used for FM, MW, LW and SW. Enter the frequency with the numbered keys. After the last key is pressed, the frequency will auto enter after a delay of a few seconds. While entering a frequency, if an incorrect frequency is entered, pressing the CLEAR/LOCK key will clear the entry in progress.

FM frequencies always have a decimal point in them, e.g. 88.5 MHz. Be sure to include this decimal point in your entry.

The slight auto-entry delay that occurs after entering the last digit of the frequency can be eliminated as follows. After entering an FM frequency, press the '.' key once. After entering a MW, SW or LW frequency that is in KHz, press the '.' key twice. With this method, the decimal key acts as an 'ENTER' key and causes immediate response to the entered frequency, eliminating the delay.

USING THE SEEK FEATURE

The SEEK feature (often called auto-tuning) enables the tuner to automatically scan and stop on stations. To engage this feature, press the SEEK key. Scanning automatically starts and will stop when a station is found. It is normal for the SEEK feature to sometimes stop on noise. The SEEK can be stopped manually by pressing the SEEK button.

APPENDIX - *etón* E1 QUICK GUIDE continued

LISTENING TO SHORTWAVE STATIONS

Absolutely no technical knowledge is necessary to fully enjoy listening to shortwave stations from around the world. It's crucial to understand 'bands'. The owner's manual's APPENDIX has all the information needed for this. Below is some condensed information.

A complete shortwave band chart is in the owner's manual. Only the most used bands are mentioned below. The band name and frequency range is shown. Note that some of the ranges below are slightly expanded compared to those in the owner's manual.

13m, 21450-21850 KHz; 16m, 17480-17900 KHz;
19m, 15100-15800 KHz; 22m, 13570-13870 KHz;
25m, 11600-12200 KHz; 31m, 9200-10000 KHz; 41m,
7100-7600 KHz; 49m, 5800-6200 KHz; 60m, 4750-
5060 KHz.

CHOOSING THE BEST SHORTWAVE BAND

Here are the best bands for the various times of day. This information is true worldwide. Notice that some bands overlap several periods of the day. It always pays to experiment.

- **SUNRISE AND EARLY MORNING**, 5 - 9 a.m.: 25, 31, 41, and 49 meters are usually good.
- **MID DAY**: 13, 16, 19, 22 and, in some areas, 25 meters. Sometimes these bands open up early, so test them in the morning too.
- **LATE AFTERNOON AND AROUND SUNSET**: 19, 22, 25, 31, 41 and 49 meters.
- **NIGHT**: 60, 49, 41, 31, 25 meters, with 49, 31 and 25 usually the best. In the summer months, the 16 and 19 meter day bands sometimes stay open at night.

GETTING INTO A SHORTWAVE BAND

Press the 'SW BAND' key twice to highlight SW BAND in the display (if the E1 is already in SW, then only one press is needed). Note that, for just a few seconds, 'SW BAND' is highlighted in the display and that the two dashes '- -' or meter band numbers are flashing in the display, under the frequency. Within 3 seconds, use the numbered keys to enter the band of your choice. Alternately, use the SELECT button or the tuning knob to scroll through the available meter bands. The new band number will replace the flashing dashes or the old band number. Stop on the band that you wish to select and it will 'autoenter' within about 3 seconds.

TUNING AROUND IN A SHORTWAVE BAND

After you have used the techniques described above to get into a shortwave band, the radio is tuned to the

lowest frequency in that band. To tune through the band you must tune upward in frequency. Use the SELECT button, TUNING knob or the SEEK button to find and tune-in stations. If you are new to shortwave, for best results, stay within the frequency ranges of the shortwave bands shown in this Quick Guide.

STORING FREQUENCIES INTO MEMORY

Storing a frequency into memory involves three basic steps: 1. Tune to the station/frequency that you wish to store. 2. Select the memory to store it into. 3. Store it.

First, tune to the station/frequency that you wish to store. To store it, do the following in a quick, smooth sequence. Press STORE, then use the TUNING knob or the SELECT key to select the desired memory number that you wish to store into. Press the STORE button twice to complete the storing process and exit the memory mode. For memory labeling instructions and other memory information, refer to the owner's manual.

ACCESSING WHAT YOU HAVE STORED INTO MEMORY

Press the MEMORY key to access the memory mode. Use the TUNING knob or the SELECT key to scroll through the memory numbers and listen to the desired stored station. To exit memory mode, press the VFO button.

DELETING THE CONTENTS OF A MEMORY

Access the desired memory channel number as described above. Press and hold the DELETE key for about 3 seconds or until its frequency disappears from the selected memory channel location. To exit memory mode, press the VFO button.

SETTING THE CLOCK TO YOUR LOCAL TIME

This procedure shows how set the clock automatically.

The receiver must be OFF with the appropriate antenna connected for WWV setting.

For manual clock setting and more detailed clock setting information, consult the owner's manual.

APPENDIX - *etón* E1 QUICK GUIDE continued

Sequentially press the button below MENU in the display until CLOCK MODES appears. If AUTO CLOCK SET is OFF, press 1 to turn it ON. If AUTO CLOCK DST is OFF, press 2 to turn it on if you want automatic daylight saving time (recommended). For LOCAL TIME OFFSET, if your country is east of the International Dateline, press 3 to set it to +. If you are west of the International Dateline, press 3 to set it to -. For example, if you live in North or South America, set it to -. To enter your specific LOCAL TIME OFFSET, press 4, then use the numeric keypad to enter the number of hours you are offset from GMT. For example, in North America use 5 hours for EST, 6 hours CST, 7 hours MST, 8 hours PST. Press 9 (EXIT) when finished. After completing the above steps the E1 must be turned off. While off, it will automatically tune to one of the National Bureau Of Standards WWV stations for automatic time-set. It will automatically tune to the strongest WWV station it can find. At night, this is likely to be 5000 or 10000 kilohertz. During the day it may use 10000, 15000 or 20000 kilohertz. If the signal is not strong enough to activate auto-time-set, see the owner's manual to set the time manually.

SETTING THE DISPLAY FOR LOCAL OR GMT TIME

With the radio turned on, sequentially press the TIME key until CLOCKS appears in the display. Select GMT or LOCAL by pressing the key to its right. When finished, press the CLEAR/LOCK button.

SETTING THE TIMER AS AN ALARM CLOCK OR SLEEP TIMER

Turn the E1 on. The following instructions are for setting and activating Timer 1 as a wake up alarm and Timer 2 as a sleep timer. Many more options are available. For more detailed timer instructions and capabilities, refer to the owner's manual.

NOTE: *The timers will reference the time that has been selected to show in the display, GMT or LOCAL. Most customers will want to display LOCAL when using the timers.*

USING TIMER 1 AS A WAKE-UP TIMER (ALARM CLOCK)

These instructions set Timer 1 to turn on as a wake-up alarm and play the last station tuned to. Once on, the E1 will play indefinitely or until turned off.

Sequentially press the MENU key to display the TIMERS MENU. Press the '1' key to highlight the turn-on time. Use the numeric keypad to enter the turn-on time in 24 hour time format. Press the STORE key.

Press the '2' key to highlight the turn-off time. Use the CLEAR/LOCK key to clear any entry that is present in this window. Press STORE to save this null entry. Press the '3' key to highlight the timer 1 mem channel. Press CLEAR/LOCK to clear any entry in the window. Press the STORE key to save this null entry. When finished, press the '9' key to exit the timer programming mode. Tune the E1 to the radio station that you wish to hear when the timer turns on. Enable the timer with the instructions provided below.

USING TIMER 2 AS A SLEEP TIMER

Sequentially press the MENU key to display the TIMERS MENU. Use the '4' key to select the turn-on time and clear any entry in this window using the CLEAR/LOCK and STORE keys as described above. Press the '5' key to set a turn-off time as in the example above. Use the '6' key to highlight the timer 2 mem ch and clear any entry that appears here using the CLEAR/LOCK and STORE keys. When finished, press the 9 key to exit the timer programming mode. Tune the E1 to the radio station that you wish to hear. Enable the timer with the instructions provided below. At the preset time, the unit will turn off and will remain off until manually turned on, or turned on by timer 1 if it is enabled.

TO ENABLE OR DISABLE THE TIMERS

Press the TIME key sequentially to show either TIMER 1 or TIMER 2 in the display. To enable the timer of your choice, press the ENABLE key and assure that that timer's number appears in the upper right corner of the display under the time. To disable the timer of your choice, press the DISABLE key and assure that its number does not appear in the upper right corner of the display under the time. To exit this mode, press the TIME key until the normal radio frequency display screen shows.

etón E1 SPECIFICATIONS

Frequency Range

- AM, LSB, USB:
 - LW: 100 to 500 kHz
 - MW: 500 to 1800 kHz
 - SW: 1800 to 30,000 kHz
- FM:
 - 76 to 90 MHz or 87 to 108 MHz, selectable

Sensitivity: SSB (10 dB S+N/N)

- Less than .25 :V 0.1 to 30 MHz (DX on)
- Less than 0.5 :V, 0.1 to 30 MHz (Normal)
- Sensitivity: AM (10 dB S+N/N) (1000 Hz, 30% Mod)
- Less than 2.0 :V 0.1 - 30 MHz (DX on)
- Less than 4.0 :V 0.1 - 30 MHz (Normal)

Sensitivity: FM (20 dB S/N) (monaural)

- Less than 1.5 :V, 87 - 108 MHz, (DX on)
- Less than 4 :V, 87 - 108 MHz, (Normal)

Frequency Resolution

- 10 Hz in SSB & AM modes
- 20 kHz in FM mode.

Frequency Stability: ± 10 ppm, 0° to 50°C

Frequency Accuracy: Better than ± 100 Hz, @ 25°C

Selectivity - SSB, AM:

- 7 kHz @ -6 dB, less than 12 kHz @ -60 dB
- 4 kHz @ -6 dB, less than 9 kHz @ -60 dB
- 2.3 kHz @ -6 dB, less than 5 kHz @ -60 dB

IF Frequency - SSB, AM:

- 1st IF 45.0 MHz
- 2nd IF 455 kHz
- FM: 1st IF: 10.7 MHz (Single Conversion)

Image Rejection

- Greater than 70 dB, 0.1 to 30 MHz
- Greater than 55 dB, 76 to 108 MHz

IF Rejection

- Greater than 80 dB, 45.0 MHz
- Greater than 80 dB, 455 kHz

IP3 - Intercept Point (@ 50 ohm Ant. Input)

- Greater than +10 dBm @ 20 kHz spacing (Normal)
- Greater than -20 dBm @ 5 kHz spacing (Normal)
 - dBm @ 20 kHz spacing (DX)
- -30 dBm @ 5 kHz spacing (DX)

AGC Performance

- Threshold: 1.0 :V
- Attack Time: 1 mSec - Bandwidth dependent.
- Release Time
 - SLOW: 3 sec.
 - FAST: 300 mSec.
- Less than 2 dB change in audio output for 90 dB
- RF input change referenced from the AGC threshold point plus 3 dB.

Internal Antenna

- 39 1/4" (1.003 meters) telescopic antenna (for use on all bands).

External Antenna

- 50 to 75 Ohms, PAL type, Male (PAL to F type adapter included)

External Speaker Output

- 4 to 8 Ohms. External jack is 1/8" (3.175 mm)

Audio Power (internal or external speaker):

- 1.25 W nominal - battery operation
- 3 W nominal - Operation from 9 VDC
- AC Adapter

Internal Speaker: 4" (10.16 cm). 8 Ohms

Line Audio Output

- Stereo left and right.
- 300 mV, 1K ohms for each output.

Line Audio Input: 300 mV, 47K ohms

Line Audio Input Jack: 1/8 inch (3.175 mm) stereo

Headphone Jack: 1/8 inch (3.175 mm) stereo

DC Power Requirements:

- Input: 7-14 VDC, supplied from AC ADAPTER W all Transformer, external DC Power Supply or 3.6 to 6.0 VDC supplied by (4) internally mounted "D" cell (1.5V) batteries (not supplied). Current requirements (approximate) from 9.0

VDC Supply:

- Worst case at max volume
- 850 mA nominal with lamp off
- 900 mA nominal with lamp on

Current requirements from Batteries with 1/4 W average Audio Output:

- Nominal battery currents
- FM mode:
 - 175 mA backlight off
 - 225 mA backlight on
- LW/MW/SW:
 - 210 mA backlight off
 - 260 mA backlight on

Operating Temperature: 0° to +50°C

Shipping Weight: 6 lbs (2.72 kg), (includes AC ADAPTER) (batteries NOT included)

Size

- Width: 13-1/8" (33.37 cm)
- Height: 7-1/2" (19.05 cm)
- Depth: 2-9/16" (6.5 cm)

Supplied AC ADAPTER

- Input: 120 VAC $\pm 10\%$, (USA Version)
- Output: 9 VDC @ 1 Amp maximum Center conductor of connector is positive. Negative is connected to input ground.

BLOCK DIAGRAM - etón E1 SIGNAL FLOW BLOCK DIAGRAM

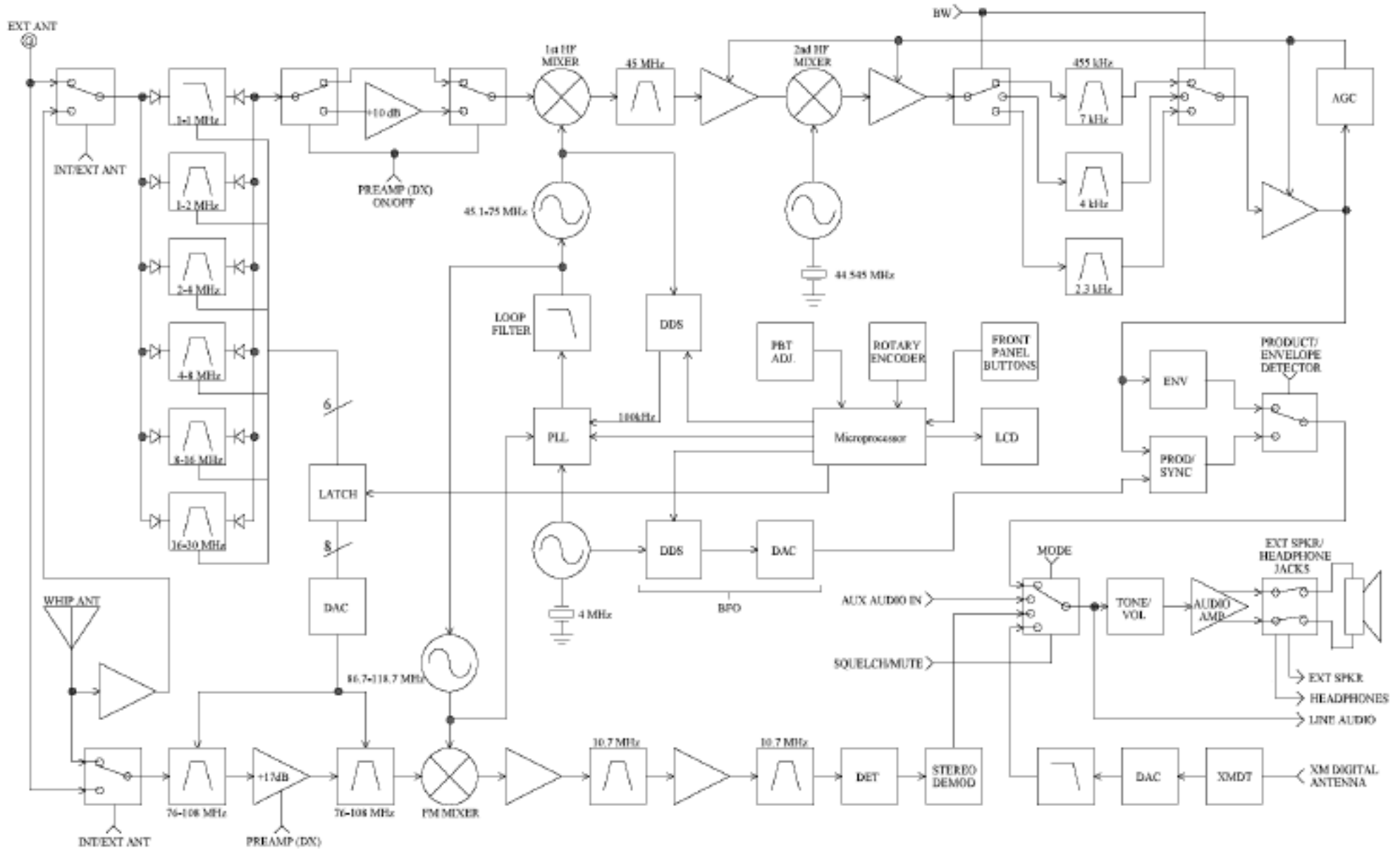

www.etoncorp.com

etón Corporation

Corporate Headquarters
1015 Corporation Way
Palo Alto, California 94303 USA
tel +1 650-903-3866
tel +1 800-872-2228
fax +1 650-903-3867

etón Corporation

Berlin Office
Rosenstrasse 2
D-10178 Berlin, Germany
tel +49 [0]30 243102149

etón Corporation

Toronto Office
1 Yonge Street, Suite 1801
Toronto, Ontario M5E 1W7 Canada
tel +1 416-214-6885

Free Manuals Download Website

<http://myh66.com>

<http://usermanuals.us>

<http://www.somanuals.com>

<http://www.4manuals.cc>

<http://www.manual-lib.com>

<http://www.404manual.com>

<http://www.luxmanual.com>

<http://aubethermostatmanual.com>

Golf course search by state

<http://golfingnear.com>

Email search by domain

<http://emailbydomain.com>

Auto manuals search

<http://auto.somanuals.com>

TV manuals search

<http://tv.somanuals.com>